



DIGITAL PIANO  
PIANO NUMÉRIQUE  
PIANO DIGITAL

# P-525

---

Owner's Manual  
Mode d'emploi  
Manual de instrucciones

English

Français

Español

Thank you for purchasing this Yamaha Digital Piano!

This instrument provides exceptionally high-quality sound and expressive control for your playing enjoyment. We recommend that you read this manual carefully so that you can fully take advantage of the advanced and convenient functions of the instrument.

We also recommend that you keep this manual in a safe and handy place for future reference.

Before using the instrument, be sure to read "PRECAUTIONS" on pages 3–4.

Merci d'avoir acheté ce Piano numérique de Yamaha !

Cet instrument offre une qualité de son et une expressivité exceptionnelles pour votre plus grand plaisir.

Nous vous conseillons de lire attentivement ce mode d'emploi afin de tirer pleinement profit des fonctions avancées et très pratiques de votre instrument.

Nous vous recommandons également de garder ce manuel à portée de main pour toute référence ultérieure.

Avant d'utiliser l'instrument, lisez attentivement la section « PRÉCAUTIONS D'USAGE » aux pages 3 et 4.

Le damos las gracias por adquirir este Piano Digital Yamaha.

Este instrumento ofrece un sonido de alta calidad y un control expresivo excepcionales para que disfrute tocando. Le aconsejamos que lea detenidamente este manual para poder disfrutar de las útiles y avanzadas funciones del instrumento.

Recomendamos guardar el manual en un lugar seguro y accesible, para futuras consultas.

Antes de utilizar el instrumento, lea las "PRECAUCIONES", en las páginas 3-4.



EN

FR

ES

## COMPLIANCE INFORMATION STATEMENT (Supplier's declaration of conformity procedure)

Responsible Party : Yamaha Corporation of America  
Address : 6600 Orangethorpe Ave., Buena Park, CA 90620, U.S.A.  
Telephone : 714-522-9011  
Type of Equipment : Digital Piano  
Model Name : P-525

This device complies with Part 15 of the FCC Rules.

Operation is subject to the following two conditions:

- 1) this device may not cause harmful interference, and
- 2) this device must accept any interference received including interference that may cause undesired operation.

(529-M02 FCC sdoc YCA 02)

## FCC INFORMATION (U.S.A.)

### 1. IMPORTANT NOTICE: DO NOT MODIFY THIS UNIT!

This product, when installed as indicated in the instructions contained in this manual, meets FCC requirements. Modifications not expressly approved by Yamaha may void your authority, granted by the FCC, to use the product.

**2. IMPORTANT:** When connecting this product to accessories and/or another product use only high quality shielded cables. Cable/s supplied with this product **MUST** be used. Follow all installation instructions. Failure to follow instructions could void your FCC authorization to use this product in the USA.

**3. NOTE:** This product has been tested and found to comply with the requirements listed in FCC Regulations, Part 15 for Class "B" digital devices. Compliance with these requirements provides a reasonable level of assurance that your use of this product in a residential environment will not result in harmful interference with other electronic devices. This equipment generates/uses radio frequencies and, if not installed and used according to the instructions found in the users manual, may cause interference harmful to the operation of other electronic devices. Compliance with FCC regulations does not guarantee that interference will not occur in all installations. If this product is found to be the source of interference, which can be determined by turning the unit "OFF" and "ON", please try to eliminate the problem by using one of the following measures:

- Relocate either this product or the device that is being affected by the interference.
- Utilize power outlets that are on different branch (circuit breaker or fuse) circuits or install AC line filter/s.
- In the case of radio or TV interference, relocate/reorient the antenna. If the antenna lead-in is 300 ohm ribbon lead, change the lead-in to co-axial type cable.

If these corrective measures do not produce satisfactory results, please contact the local retailer authorized to distribute this type of product. If you can not locate the appropriate retailer, please contact Yamaha Corporation of America, 6600 Orangethorpe Avenue, Buena Park, CA 90620, U.S.A.

The above statements apply **ONLY** to those products distributed by Yamaha Corporation of America or its subsidiaries.

(529-M04 FCC class B YCA 02)

The model number, serial number, power requirements, etc., may be found on or near the name plate, which is at the bottom of the unit. You should note this serial number in the space provided below and retain this manual as a permanent record of your purchase to aid identification in the event of theft.

**Model No.**

---

**Serial No.**

---

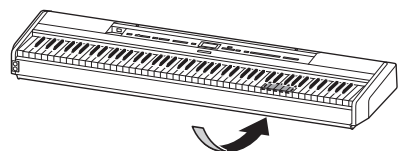

The name plate is located on the bottom of the unit.

(1003-M06 plate bottom en 01)

# PRECAUTIONS

## PLEASE READ CAREFULLY BEFORE PROCEEDING

Especially in the case of children, a guardian should provide guidance on how to properly use and handle the product before actual use.

Please keep this manual in a safe and handy place for future reference.



## WARNING

**Always follow the basic precautions listed below to avoid the possibility of serious injury or even death from electrical shock, short-circuiting, damages, fire or other hazards. These precautions include, but are not limited to, the following:**

### Power supply

- Do not place the power cord near heat sources such as heaters or radiators. Also, do not excessively bend or otherwise damage the cord, or place heavy objects on it.
- Do not touch the product or the power plug during an electrical storm.
- Use only the correct voltage specified for the product. The required voltage is printed on the name plate of the product.
- Use only the supplied or the specified AC adaptor (page 118)/power cord. Do not use the AC adaptor/power cord for other devices.
- Check the power plug periodically and remove any dirt or dust which may have accumulated on it.
- Insert the power plug firmly all the way into the AC outlet. Using the product when it is not plugged in sufficiently can cause dust to accumulate on the plug, possibly resulting in fire or skin burns.
- When setting up the product, make sure that the AC outlet you are using is easily accessible. If some trouble or malfunction occurs, immediately turn off the power switch and disconnect the plug from the outlet. Even when the power switch is turned off, as long as the power cord is not unplugged from the wall AC outlet, the product will not be disconnected from the power source.
- Do not connect the product to an electrical outlet using a multi-plug outlet extender. Doing so can

result in lower sound quality, or possibly cause overheating in the outlet.

- When disconnecting the power plug, always hold the plug itself and not the cord. Pulling by the cord can damage it and cause electric shocks or a fire.
- If not using the product for long periods of time, be sure to pull the power plug from the AC outlet.

### Do not disassemble

- This product contains no user-serviceable parts. Do not attempt to disassemble the internal parts or modify them in any way.

### Water warning

- Do not expose the product to rain, use it near water or in damp or wet conditions, or place on it any containers (such as vases, bottles or glasses) containing liquids which might spill into any openings or places where water may drop. A liquid such as water getting into the product may cause a fire, electric shocks, or malfunctions.
- Use the AC adaptor indoors only. Do not use in any wet environments.
- Never insert or remove a power plug with wet hands.

### Fire warning

- Do not place any burning items or open flames near the product, since they may cause a fire.

### Wireless unit

- Radio waves from this product may affect electro-medical devices, such as a heart pacemaker implant or defibrillator implant.
  - Do not use the product near medical devices or inside medical facilities. Radio waves from this product may affect electro-medical devices.
  - Do not use the product within 15 cm (6 in.) of persons with a heart pacemaker implant or a defibrillator implant.

### Connections

- Be sure to read the manual of the device to be connected, and follow the instructions. Failure to observe this may cause a fire, overheating, explosion, or malfunction.

## If you notice any abnormality

---

- If any of the following problems occur, immediately turn off the power switch and disconnect the power plug from the outlet. Finally have the device inspected by Yamaha service personnel.
  - The power cord or plug becomes frayed or damaged.
  - Unusual smells or smoke are emitted.
  - Some object, or water has been dropped into the product.
  - There is a sudden loss of sound during use of the product.
  - Cracks or other visible damage appear on the product.

### **CAUTION**

---

**Always follow the basic precautions listed below to avoid the possibility of physical injury to you or others, or damage to the instrument or other property. These precautions include, but are not limited to, the following:**

### Location

---

- Do not place the product in an unstable position or a location with excessive vibration, where it might accidentally fall over and cause injury.
- Do not go near the product during an earthquake. Strong shaking during an earthquake could cause the product to move or tip over, resulting in damage to the product or its parts, and possibly causing injury.
- When transporting or moving the product, always use two or more people. Attempting to lift the product by yourself may result in injuries, such as back injuries, or cause the product to be dropped and broken, which could lead to other injuries.
- Before moving the product, remove all connected cables, to prevent damage to the cables or injury to anyone who might trip over them.
- Use only the stand specified for the product. When attaching it, use the provided screws only. Failure to do so could cause damage to the internal components or result in the product falling over.

## Connections

---

- Before connecting the product to other devices, turn off the power for all devices. Before turning the power on or off for all devices, set all volume levels to minimum.
- Be sure to set the volumes of all devices at their minimum levels and gradually raise the volume controls while playing the product to set the desired listening level.

## Handling

---

- Do not insert foreign materials such as metal or paper into any openings or gaps of the product. Failure to observe this may cause a fire, electric shocks, or malfunctions.
- Do not rest your weight on, or place heavy objects on the product, and do not use excessive force on the buttons, switches or connectors.
- Do not use the product or headphones for a long period of time at a high or uncomfortable volume level, since this can cause permanent hearing loss. If you experience any hearing loss or ringing in the ears, consult a physician.
- Remove the power plug from the AC outlet before cleaning the unit. Failure to observe this may cause electric shocks.

Yamaha cannot be held responsible for damage caused by improper use or modifications to the product, or data that is lost or destroyed.

Always turn the power off when the instrument is not in use.

Even when the [⏻] (Standby/On) switch is in standby status (power lamp is off), electricity is still flowing to the instrument at the minimum level. When you are not using the instrument for a long time, make sure you unplug the power cord from the wall AC outlet.

(DMI-11)

# NOTICE

---

To avoid the possibility of malfunction/ damage to the product, damage to data, or damage to other property, follow the notices below.

## ■ Handling

- Do not connect this product to a public Wi-Fi and/or Internet service directly. Only connect this product to the Internet through a router with strong password protections. Consult your router manufacturer for information on optimum security practices.
- Do not use this product in the vicinity of a TV, radio, stereo equipment, mobile phone, or other electric devices. Otherwise, this product or the other device may generate noise.
- When you use the product along with an app on your smart device, such as a smartphone or tablet, we recommend that you enable “Airplane Mode” on the device to avoid noise caused by communication. When turning on airplane mode, **Bluetooth**® settings may be turned off. Make sure that the setting is turned on before use.
- Do not expose the product to excessive dust or vibrations, or extreme cold or heat (such as in direct sunlight, near a heater, or in a car during the day) to prevent the possibility of disfiguration, damage to the internal components or unstable operation. (Verified operating temperature range: 5° – 40°C, or 41° – 104°F.)
- Do not place vinyl, plastic or rubber objects on the product, since this might discolor the product.

## ■ Maintenance

- When cleaning the product, use a soft and dry (or slightly damp) cloth. Do not use paint thinners, solvents, alcohol, cleaning fluids, or chemical-impregnated wiping cloths.
- During extreme changes in temperature or humidity, condensation may occur and water may collect on the surface of the product. If water is left, the wooden parts may absorb the water and be damaged. Make sure to wipe any water off immediately with a soft cloth.

## ■ Saving data

- Some of the data of this product (page 90) and the Song data saved to the internal memory of this instrument (page 54) are retained when the power is turned off. However, the saved data may be lost due to some failure, an operational mistake, etc. Save your important data onto USB flash drive/an external device such as a computer (pages 68, 90). Before using a USB flash drive, make sure to refer to page 75.
- To protect against data loss through USB flash drive damage, we recommend that you save your important data onto spare USB flash drive or an external device such as a computer as backup data.

# Information

---

## ■ About copyrights

- The copyright of the “content”<sup>\*1</sup> installed in this product belongs to Yamaha Corporation or its copyright holder. Except as permitted by copyright laws and other relevant laws, such as copying for personal use, it is prohibited to “reproduce or divert”<sup>\*2</sup> without the permission of the copyright holder. When using the content, consult with a copyright expert.

If you create music or perform with the contents through the original use of the product, and then record and distribute them, the permission of Yamaha Corporation is not required regardless of whether the distribution method is paid or free of charge.

\*1: The word “content” includes a computer program, audio data, Accompaniment Style data, MIDI data, waveform data, voice recording data, music score, and score data, etc.

\*2: The phrase “reproduce or divert” includes taking out the content itself in this product, or recording and distributing it without changes in a similar manner.

## ■ About functions/data bundled with the product

- Some of the preset Songs have been edited for length or arrangement, and may not be exactly the same as the original.
- This device is capable of using various types/formats of music data by optimizing them to the proper format music data for use with the device in advance. As a result, this device may not play them back precisely as their producers or composers originally intended.
- The bitmap fonts used in this product have been provided by and are the property of Ricoh Co., Ltd.

## ■ About this manual

- The illustrations and LCD screens as shown in this manual are for instructional purposes only.

## ■ Tuning

- Unlike an acoustic piano, this instrument does not need to be tuned by an expert (although the pitch can be user-adjusted to match other instruments). This is because the pitch of digital instruments is always maintained perfectly.

## ■ About disposal

- When disposing of this product, please contact the appropriate local authorities.

Thank you for purchasing this Yamaha Digital Piano!  
This instrument provides exceptionally high-quality sound and expressive control for your playing enjoyment. In order to make the most of your instrument's performance potential and features, please read this Owner's Manual thoroughly, and keep it in a safe place for later reference.

## About the Manuals

---

This instrument has the following manuals.





### Supplied with the instrument

- **P-525 Owner's Manual**

Explains how to use this instrument.

#### General contents of the notes

 <b>WARNING</b>	Important information to avoid the possibility of serious injury or even death from electrical shock, short-circuiting, damages, fire or other hazards.
 <b>CAUTION</b>	Important information to avoid the possibility of physical injury to you or others, or damage to the instrument or other property.
<b>NOTICE</b>	Important information to avoid the possibility of malfunction or damage to the product, damage to data, or damage to other property.
<b>NOTE</b>	Helpful information and tips.
	Means that operating procedure or explanation continues to the next page.



### Available on the website

- **Smart Pianist User Guide**

Explains how to set up and use a smart device with the dedicated Smart Pianist app (page 81) for controlling this instrument.

- **Smart Device Connection Manual**

Explains how to connect the instrument to smart devices, such as a smartphone, tablet, etc.

- **Data List**

Contains list of XG Voices and XG Drum Kit and MIDI-related information.

To obtain these manuals, access the Yamaha website below:

#### Yamaha Downloads

<https://download.yamaha.com/>

After selecting your country and clicking on "Manual Library," enter the model name, etc. to search for the desired files.



\* For a general overview of MIDI and how you can effectively use it, search for "MIDI Basics" (only in English, German, French and Spanish) on the website above.

# Included Accessories

---

- Owner's Manual (this book) × 1
  - Online Member Product Registration × 1
  - Foot Pedal × 1
  - Power cord\*, AC adaptor\* × 1
- \* May not be included depending on your particular area. Please check with your Yamaha dealer.
- Music Rest × 1

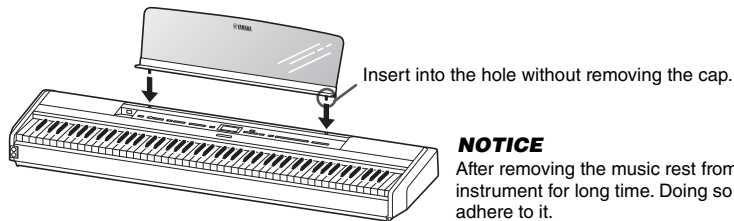

### NOTICE

After removing the music rest from the instrument, do not leave it on the instrument for long time. Doing so may cause color transference or glue to adhere to it.

# Compatible Formats

---



## GM System Level 2

“GM (General MIDI)” is one of the most common Voice allocation formats. “GM System Level 2” is a standard specification that enhances the original “GM” and improves Song data compatibility. It provides for increased polyphony, greater Voice selection, expanded Voice parameters, and integrated effect processing.



## XG

XG is a major enhancement of the GM System Level 1 format, and was developed by Yamaha specifically to provide more Voices and variations, as well as greater expressive control over Voices and effects, and to ensure compatibility of data well into the future.



## GS

GS was developed by the Roland Corporation. In the same way as Yamaha XG, GS is a major enhancement of the GM specifically to provide more Voices and Drum kits and their variations, as well as greater expressive control over Voices and effects.

# Table of Contents

<b>PRECAUTIONS</b> .....	3
<b>NOTICE</b> .....	5
<b>Information</b> .....	5
<b>About the Manuals</b> .....	6
<b>Included Accessories</b> .....	7
<b>Compatible Formats</b> .....	7
<b>Features</b> .....	9
<b>Panel Controls and Terminals</b> .....	10
<b>Setting Up</b> .....	12
Power Requirements .....	12
Turning the Power On or Off .....	12
Setting the Volume — [VOLUME] .....	13
Using Headphones .....	14
Using the Pedals .....	15
<b>Basic Operations on Display</b> .....	18
<b>Playing Various Musical Instrument Sounds (Voices)</b> .....	20
Selecting Voices .....	20
Listening to the Voice Demos .....	22
Customizing the Sound and the Touch Response of Piano Voices (Piano Room) .....	23
Enhancing and Customizing the Sound .....	26
Playing Two Voices Simultaneously (Dual) .....	29
Splitting the Keyboard Range and Playing Two Different Voices (Split Mode) .....	30
Using Dual and Split Simultaneously .....	31
Playing Duo .....	32
Transposing the Pitch in Semitones (Transpose) .....	34
Fine Tuning the Pitch (Master Tune) .....	35
Changing the Touch Sensitivity (Touch) .....	36
Boosting the Overall Sound (Sound Boost) .....	37
Adjusting the Sound (Master EQ) .....	38
Locking the Front Panel .....	40
Using the Metronome .....	41
<b>Playing the Keyboard along with Rhythm Playback</b> 43	
<b>Playing and Practicing Songs</b> .....	44
Playback of Songs .....	45
Playing a One-hand Part — Part Cancel Function (MIDI Songs) .....	48
Playing Back a Song Repeatedly .....	49
Adjusting the Volume Balance .....	52
Useful Playback Functions .....	53
<b>Recording Your Performance</b> .....	54
Recording Methods .....	54
Quick MIDI Recording .....	55
MIDI Recording — Independent Tracks .....	57
MIDI Recording to the USB Flash Drive .....	59
Audio Recording to the USB Flash Drive .....	61
Other Recording Techniques .....	62
<b>Handling Song Files</b> .....	66
Song Types and File Operation Limitations .....	66
Basic Song File Operation .....	67
Deleting Files — Delete .....	68
Copying Files — Copy .....	68
Moving Files — Move .....	69
Converting a MIDI Song to an Audio Song during Playback — MIDI to Audio .....	70
Renaming Files — Rename .....	71
<b>Saving and Recalling Desired Settings (Registration Memory)</b> .....	72
Saving the Settings to the Registration Memory .....	72
Recalling a Registered Setting .....	73
<b>Connecting to Other Devices</b> .....	74
Connectors .....	74
Connecting USB Devices ([  ] (USB TO DEVICE) Terminal) .....	75
Connecting to an Audio Player ([AUX IN] jack) .....	76
Using an External Speaker System for Playback (AUX OUT [L/L+R]/[R] jacks) .....	76
Connecting to a Computer or Smart Device .....	77
Transmitting/Receiving Audio Data (USB Audio Interface Function) .....	78
Listening to Audio Data from a Smart Device through this Instrument (Bluetooth Audio Function) .....	79
Using Smart Device Apps with a Connected Smart Device .....	81
Connecting External MIDI Devices (MIDI Terminals) .....	89
<b>Backup and Initialization</b> .....	90
<b>Performing Live</b> .....	92
<b>Detailed Settings (MENU Display)</b> .....	94
Common Operations in the Menu Displays .....	94
Voice Menu .....	95
Song Menu .....	98
Metronome/Rhythm Menu .....	101
Recording Menu .....	102
System Menu .....	103
<b>Appendix</b> .....	110
Preset Voice List .....	110
Song List .....	112
Rhythm List .....	112
Message List .....	113
Troubleshooting .....	115
Specifications .....	117
<b>Index</b> .....	119

\*For information on whether Bluetooth functionality is included or not, refer to page 80.



# Features



## Truly Portable electric piano, ideal for wide variety of applications

The P-525 digital piano is exceptionally portable—allowing you practice it in your bedroom, or perform with it at a party. You can enjoy it like a normal piano when using it with the separately sold keyboard stand (L-515) and pedal unit (LP-1). You can also enjoy authentic live performances when using it with the portable pedal unit (FC35).



## Yamaha CFX and Bösendorfer Imperial piano samples

The P-525 features gorgeous piano sounds created with samples of the Yamaha CFX flagship concert grand piano and famed Vienna-made Bösendorfer\* grand piano. These piano samples bring two world's finest and most prominent concert grand pianos to your fingertips.

\* Bösendorfer is a subsidiary company of Yamaha.



## Grand Expression Modeling and Virtual Resonance Modeling (VRM) — two powerful, expressive grand piano-like features (page 24)

“Grand Expression Modeling” technology recreates the subtle changes in the sound that are produced by changing your touch from when you press a key to when you release it. The VRM technology featured in this instrument reproduces the complicated interaction of both string and soundboard resonance and makes the sound more like a real acoustic piano. These two technologies enables a wide variety of performance expression.



## GrandTouch-S™ keyboard with real wood keys provides the feel of an acoustic grand piano

The P-525 features white keys made from select quality wood and fitted with the highest quality synthetic ivory, while the black keys are finished in synthetic ebony. This keyboard features a broad dynamic range and faithful response to every nuance of touch that puts a wide expanse of tone—from delicate to bold—at the pianist's fingertips.



## Dynamic Rhythm Tracks (page 43)

The P-525 comes complete with forty rhythm patterns (drums and bass accompaniment) that are perfectly suited to many types of music regularly performed on the piano, for even greater performance potential. Simply playing with your favorite rhythm pattern automatically triggers and controls the drums and bass accompaniment, and you can enjoy the feeling of playing with a backing band.



## Convenient on-stage performance functions (page 92)

The P-525 also features the following useful functions for performing on stage or in live spaces.

- **Sound Boost (page 37)**

This helps your sound stand out when playing along with other instruments or in noisy environments.

- **Panel Lock (page 40)**

This allows you temporarily disable the front panel buttons to prevent them being operated unintentionally while performing.

- **Registration Memory (page 72)**

This allows you to save (register) your favorite settings to buttons on the front panel, and then instantly recall the settings while performing.



## Comprehensive compatibility with smart devices

Connecting the P-525 with a smart device, such as a smartphone or tablet, gives you even greater musical enjoyment and performance control.

- **Powerful, convenient smart device apps (page 81)**

The P-525 is compatible with two highly convenient apps: Smart Pianist and Rec'n'Share. Smart Pianist lets you operate the instrument from your smart device and even display the notation of Songs, while Rec'n'Share enables you to film, record, and edit your performances.

- **Bluetooth audio function enables audio playback from a smart device (page 79)**

You can use the P-525 as an audio device, and listen to music from your Bluetooth-equipped device, such as a smart device, and even enjoy performing with your favorite music.

# Panel Controls and Terminals

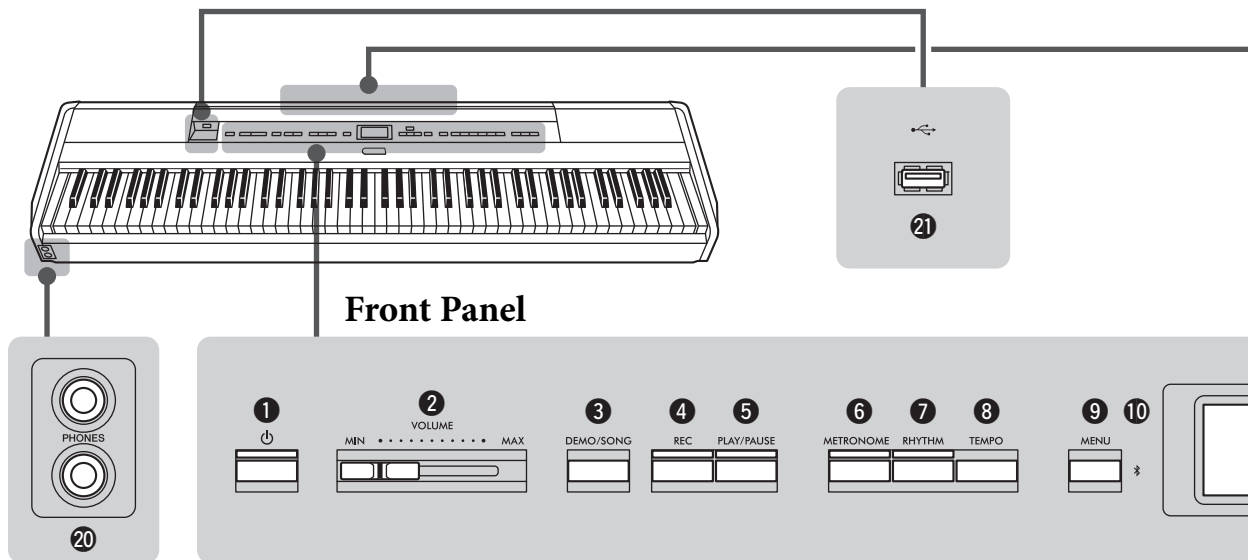

## Front Panel

- 1** [⏻] (Standby/On) switch ..... page 12  
For turning the power on or setting it to standby.
- 2** [VOLUME] slider ..... page 13  
For adjusting the overall volume.
- 3** [DEMO/SONG] button ..... pages 22, 44  
Calls up Song List folders for selecting Songs for playback, etc.
- 4** [REC] button ..... page 54  
For recording your keyboard performance.
- 5** [PLAY/PAUSE] button ..... page 45  
For alternately playing back and pausing the Preset Songs or your recorded material.
- 6** [METRONOME] button ..... page 41  
For using the metronome functions.
- 7** [RHYTHM] button ..... page 43  
For using the rhythm functions.
- 8** [TEMPO] button ..... page 41  
For setting the tempo.
- 9** [MENU] button ..... page 94  
Pressing this button alternates the displays among the “Voice,” “Song,” “Metronome/Rhythm,” “Recording” and “System” menus, from which you can make detailed settings for the related functions.

- 10** ✱ (Bluetooth) ..... pages 79, 82  
The Bluetooth function enables you to listen to audio data from a smart phone, or use the smart device app “Smart Pianist.”

### Bluetooth capability

Depending on the country in which you purchased the product, the instrument may not have Bluetooth capability. If the Bluetooth logo is shown or printed on the control panel, this means that the product is equipped with Bluetooth functionality.

- 11** [▲]/[▼]/[◀]/[▶] buttons, display ..... page 18  
For selecting an item or setting a value using the buttons corresponding to the display indication.
- 12** [EXIT] button  
Pressing this button exits from the current display, or returns to the Voice or Song display.
- 13** [PIANO ROOM] button ..... page 23  
Calls up the Piano Room display where you can select an optimum piano sound and adjust the touch response.
- 14** Voice buttons ..... page 20  
For selecting the Voice (keyboard sound).
- 15** Registration Memory related buttons ..... page 72  
For registering and recalling settings.

## Rear Panel

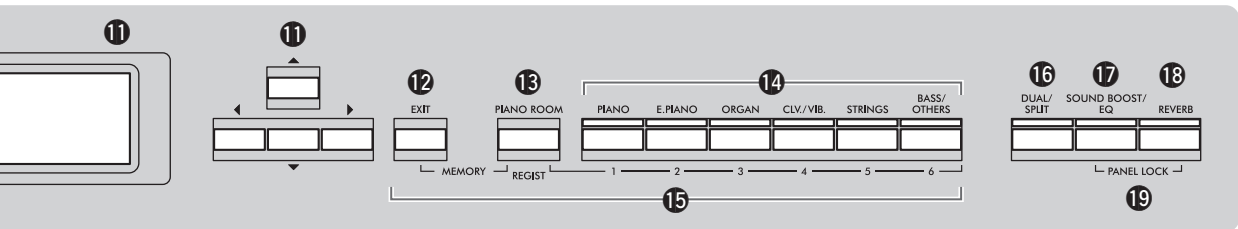
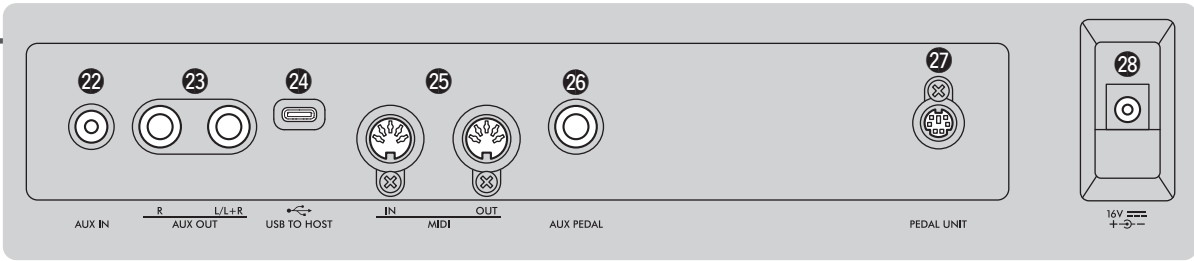

- 16 [DUAL/SPLIT] button** ..... pages 29, 30, 31  
For playing two Voices simultaneously, or different Voices on the left- and right-hand sections of the keyboard.
- 17 [SOUND BOOST/EQ] button** ..... pages 37, 38  
Calls up the Sound Boost or Master EQ display. These allow you to raise the volume and enhance the presence of your performance (Sound Boost), or adjust the tone of the sound (Master EQ).
- 18 [REVERB] button** ..... page 26  
Calls up the Reverb display, for adding and changing reverberation in the sound.
- 19 [PANEL LOCK] buttons** ..... page 40  
For temporarily disabling the front panel buttons to prevent them being operated unintentionally while performing.
- 20 [PHONES] jacks** ..... page 14  
For connecting a pair of headphones.
- 21 [ ] (USB TO DEVICE) terminal** ..... pages 74, 75  
For connecting a USB flash drive or using a USB wireless LAN adaptor to connect with a smart device such as a smartphone.
- 22 [AUX IN] jack** ..... pages 74, 76  
For connecting an audio player, such as a portable audio player.
- 23 AUX OUT [R]/[L/L+R] jacks** ..... pages 74, 76  
For connecting to external powered speaker systems, etc.
- 24 [USB TO HOST] terminal** ..... pages 74, 77  
For connecting a computer or a smart device, such as a smartphone or tablet.
- 25 MIDI [IN] [OUT] terminals** ..... pages 74, 89  
For connecting external MIDI devices, such as a synthesizer or a sequencer.
- 26 [AUX PEDAL] jack** ..... pages 15, 74  
For connecting an included foot pedal, or separately sold foot switch.
- 27 [PEDAL UNIT] terminal** ..... page 15  
Connecting a separately sold pedal unit.
- 28 DC IN jack** ..... page 12  
For connecting the included or specified AC adaptor.

# Setting Up

## Power Requirements

Connect the AC adaptor and the power cord in the order shown in the illustration.

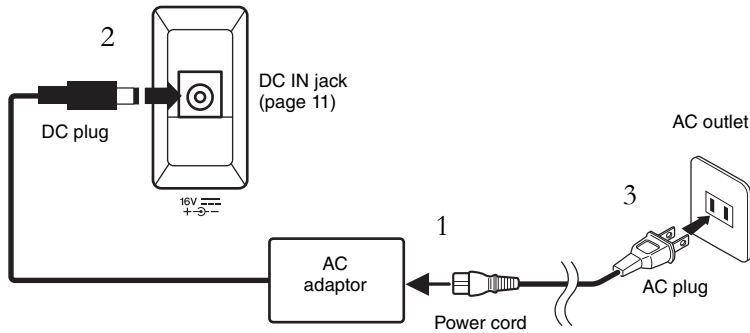

### **⚠ WARNING**

- Use only the AC power cord supplied with your instrument. If the supplied cord is lost or damaged and needs to be replaced, contact your Yamaha dealer. The use of an inappropriate replacement can pose a fire and shock hazard!
- When setting up the product, make sure that the AC outlet you are using is easily accessible. If some trouble or malfunction occurs, immediately turn off the power switch and disconnect the plug from the outlet.

### **NOTE**

When disconnecting the power cord/AC adaptor, first turn off the power, then follow this procedure in reverse order.

## Turning the Power On or Off

1. Turn down the [VOLUME] slider at the right end of the front panel to “MIN.”

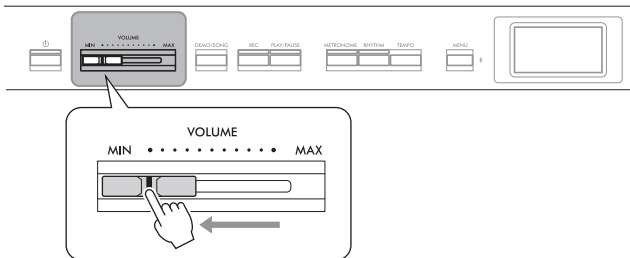

2. Press the [⏻] (Standby/On) switch to turn the power on.

The [⏻] (Standby/On) switch lights up and the Voice display appears on the display at the center of the front panel.

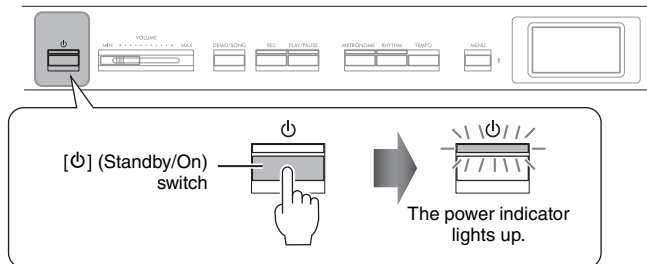

3. Press and hold the [⏻] (Standby/On) switch for a second to turn the power off.

The display and the [⏻] (Standby/On) button lamp both turn off.

### **NOTICE**

Press only the [⏻] (Standby/On) switch when turning the power on. Any other operations, such as pressing the keys, buttons or pedals may cause the instrument to malfunction.

### **⚠ WARNING**

Even when the instrument is turned off, electricity is still flowing to the instrument at the minimum level. When you are not using the instrument for a long time or during electrical storms, make sure you unplug the AC power plug from the wall AC outlet.

### **NOTICE**

Turning the power off while recording or editing might cause data loss. If you need to force-quit the instrument, hold down the [⏻] (Standby/On) switch for longer than three seconds. Note that the force-quit operation might cause loss of the Pairing information for Bluetooth audio function.

## Auto Power Off function

To prevent unnecessary power consumption, this instrument features an Auto Power Off function that automatically turns the power off if the instrument is not operated for a specified period of time. The amount of time that elapses before the power is automatically turned off is approximately 30 minutes by default; however, you can change the setting (page 106).

### Disabling Auto Power Off (simple method)

Turn the power on while holding down the lowest key on the keyboard. An “Auto power off disabled” message appears briefly and Auto Power Off is disabled.

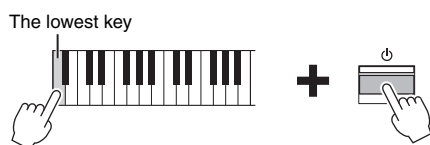

## Setting the Volume — [VOLUME]

To adjust the volume, use the [VOLUME] slider located at the right of the panel. Play the keyboard to actually produce sound while you adjust the volume.

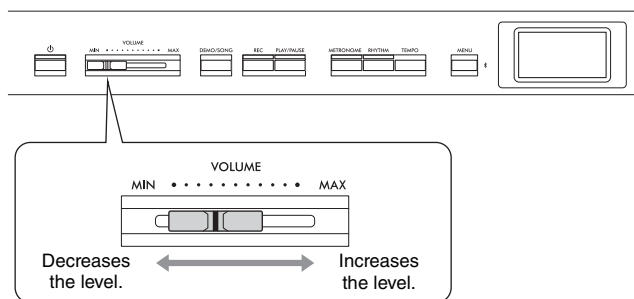

Adjusting the [VOLUME] slider also affects the output level of the [PHONES] jacks (page 14) and the output level of the AUX OUT jacks (page 76).

## Intelligent Acoustic Control (IAC)

IAC is a function which automatically adjusts and controls the sound quality according to the overall volume of the instrument. IAC Control is effective only on the sound output of the instrument speakers or headphones. Even when the volume is low, this lets you hear both low sounds and high sounds clearly. Especially when using the headphones, the burden on the ears is reduced without raising the overall volume excessively.

You can set the IAC setting On or Off and its depth. For details, refer to “IAC” and “IAC depth” on page 105. The default setting for this function is “On.”

### NOTICE

- Any data which are not saved will be lost if the power automatically turns off. Make sure to save your data before this happens.
- Depending on the instrument status, the power may not turn off automatically, even after the specified period of time elapses. Always turn off the power manually when the instrument is not in use.

### CAUTION

Do not use the instrument at a high volume level for a long period of time, or your hearing may be damaged.

## Using Headphones

You can connect two pairs of headphones to the [PHONES] jacks. If you are using only one pair, insert the plug into either of these jacks.

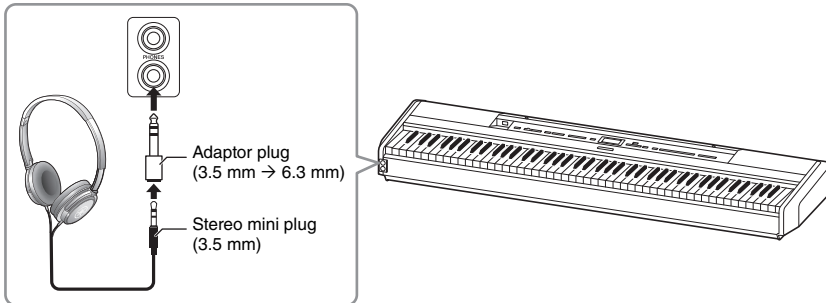

### **CAUTION**

Do not use headphones at a high volume for an extended period of time. Doing so may cause hearing loss.

## Reproducing the Natural Sensation of Sound Distance — Binaural Sampling and Stereophonic Optimizer

This instrument features two advanced technologies that allow you to enjoy exceptionally realistic, natural sound, even when listening on headphones.

### Binaural Sampling (“CFX Grand” Voice only)

Binaural sampling is a method that uses two special microphones set at the ear position of a performer and records the sound from a piano as it is. Listening to the sound with this effect through headphones gives the impression of being immersed in the sound, as if it was actually emanating from the piano. When “CFX Grand” (page 110) is selected, connecting the headphones automatically enables binaural sampling sound.

### Stereophonic Optimizer (Voices in the Piano group other than “CFX Grand”)

The Stereophonic Optimizer is an effect which reproduces natural sound distance like the sound of binaural sampling even though you hear it on headphones. When any other Voice in the Piano group besides “CFX Grand” is selected, connecting the headphones automatically enables the Stereophonic Optimizer.

This function is turned on by default. Note that when the “Speaker” setting (page 106) is “On,” this function will always be disabled. Since these sounds are optimized for listening with headphones, we recommend that you set this function to “Off” in the following situations.

- Playing the piano sound of this instrument with an external powered speaker system, while monitoring the sound output from this instrument on connected headphones.
- Making an audio recording (page 61) while using headphones, and then playing that recorded audio Song through speakers of this instrument. (Make sure to turn off these functions before audio recording.)

For details on setting this On or Off, refer to “Binaural” on page 105.

### Sampling

A technology which records the sounds of an acoustic instrument then stores them to the tone generator to be played based on information received from the keyboard.

### NOTE

Voices in the Piano group are those contained in the “Piano” category in the Preset Voice List (page 110). For details about selecting Voices, refer to page 20.

### NOTE

Before connecting an external powered speaker system, be sure to read “Connecting to Other Devices” (page 74).

## Using the Pedals

### Using the Foot Pedal

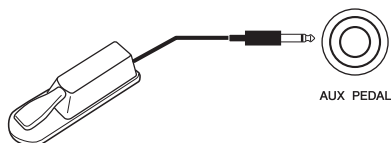

You can switch various selected functions on/off by using the included FC3A foot pedal connected to the [AUX PEDAL] jack. Also a separately sold FC4A or FC5 footswitch can be connected to the jack. To select the function, use the “Aux Assign” (page 104) in the “System” menu display.

#### NOTE

Make sure that power is off when connecting or disconnecting the foot pedal or footswitch.

#### Half-pedal function

This function can be used when an included FC3A foot pedal or separately sold LP-1 or FC-35 pedal unit (see below) is connected and it allows you to vary the sustain length depending on how far the pedal is pressed. The farther down you press the pedal, the more the sound sustains. You can specify the point to which you must depress the foot pedal connected to the [AUX PEDAL] jack or the damper pedal of the pedal unit (Half Pedal Point). To do this, press the [MENU] button repeatedly to call up the “System” menu display: “Pedal” → “Half Pedal Point” (page 104).

### Using the Pedal Unit (sold separately)

The [PEDAL UNIT] jack is for connecting a separately sold LP-1 or FC35 pedal unit. When connecting the LP-1 pedal unit, make sure to also assemble the unit on a separately sold keyboard stand (L-515). When connecting the FC35 pedal unit, a keyboard stand is unnecessary.

#### NOTE

Make sure that power is off when connecting or disconnecting the pedal unit.

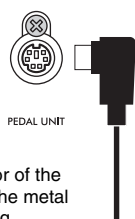

Insert the connector of the unit securely until the metal part of the cord plug disappears from view in the same direction as shown in the illustration. Otherwise, the connector may be broken and the pedal may not function properly.

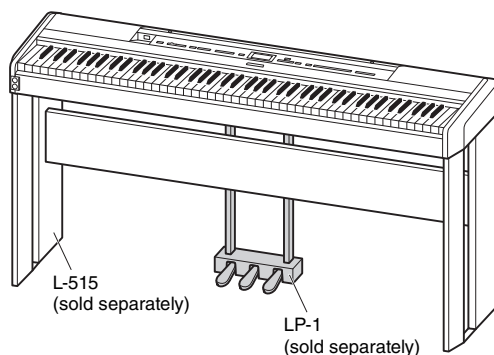

## Damper pedal (right pedal)

When you press the damper pedal, the notes you play have a longer sustain. When you select a Voice in the Piano group, pressing the damper pedal activates the VRM (page 24) to accurately recreate the unique resonance of an acoustic grand piano's soundboard and strings. This pedal features Half-pedal function.

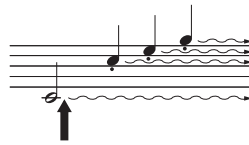

When you press the damper pedal here, the notes you play before you release the pedal have a longer sustain.

## Sostenuto pedal (center pedal)

If you play a note or chord on the keyboard and press the sostenuto pedal while holding the note(s), the notes will sustain as long as the pedal is held. All subsequent notes will not sustain.

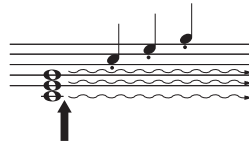

When you press the sostenuto pedal here while holding the note(s), the notes will sustain as long as you hold the pedal.

## Soft pedal (left pedal)

The soft pedal reduces the volume and slightly changes the timbre of notes played while the pedal is pressed. The soft pedal will not affect notes that are already playing when it is pressed. In order to apply this effect, play notes after pressing the pedal.

Keep in mind that this pedal function will be changed from the Soft pedal depending on the selected Voice (page 20). When “Jazz Organ” or “Rock Organ” is selected, this pedal switches the Rotary Speaker speed between slow and fast (“Rotary Speed” on page 96). When “Vibraphone” is selected, this pedal switches Vibrato on and off (“VibeRotor” on page 96).

## Assigning Functions to the Pedals

You can assign a different function to the foot pedal or footswitch connected to the [AUX PEDAL] jack or left/center/right pedal connected to the [PEDAL UNIT] jack.

### Assigning to the foot pedal/footswitch

Press the [MENU] button repeatedly to call up the “System” menu, and then select “Pedal” → “Aux Assign” to make the assignment.

### Assigning to each pedal of the pedal unit

Press the [MENU] button repeatedly to call up the “Voice” menu, and then select “Pedal Assign” to make the assignment.

#### NOTE

Voices in the Piano group are those contained in the “Piano” category in the Preset Voice List (page 110). For details about selecting Voices, refer to page 20.

#### NOTE

While the sostenuto (center) pedal is held, a sustained (non-decaying) type of Voice such as strings or organ may sound continuously without decay after the notes have been released.

#### NOTE

You can assign the Song Play/Pause function (the same function as the [PLAY/PAUSE] button on the front panel) to the included foot pedal connected to the [AUX PEDAL] jack or the footswitch (sold separately) or the center or left pedal of the pedal unit (sold separately). For details, refer to page 104.



## Pedal Function List

Function	Description	Available pedal (○: Can be assigned, ×: Cannot)			
		Pedal Unit			Foot pedal or Footswitch
		Left pedal	Center pedal	Right pedal	
Sustain (Switch)	A function that sustains the notes you play while pressing the pedal, even after releasing your fingers from the keyboard	○	○	○	○
Sustain (Continuous)*	A function that varies the sustain length depending on how far the pedal is pressed	×	×	○***	○***
Sostenuto	Sostenuto (page 16)	○	○***	○	○
Soft	Soft (page 16)	○	○	○	○
PitchBend Up*	A function that smoothly raises the pitch	×	×	○	○
PitchBend Down*	A function that smoothly lowers the pitch	×	×	○	○
Rotary Speed**	Changes the rotational speed of the Jazz Organ or Rock Organ rotary speaker (switches between fast and slow each time you press the pedal)	○	○	○	○
VibeRotor**	Switches the vibraphone vibrato on/off (switches on/off each time you press the pedal)	○	○	○	○

The default function for the Left pedal differs depending on the current Voice.  
Jazz Organ, Rock Organ: Rotary Speed, Vibraphone: VibeRotor, Voices other than the above: Soft

\*: When you want to assign a function indicated by \* to the pedal connected to the [AUX PEDAL] jack, you should use a separately sold foot pedal (page 15).

\*\* : The functions marked with \*\* are assigned to the Left pedal automatically when you select the Jazz Organ, Rock Organ, or Vibraphone Voice.

\*\*\*: The functions marked with \*\*\* is the default function when foot pedal/footswitch/pedal unit is connected.

# Basic Operations on Display

In addition to the front panel buttons, the instrument also features detailed control via the display menus—allowing you to select from the wealth of Voices and Songs included, as well as changing various detailed instrument settings, for even greater playability and performance potential.

## Voice display (page 20)

1. Press a Voice button to call up the Voice display.

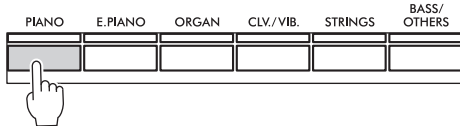

2. Use the [◀]/[▶] buttons to select the previous or next Voice. Press the [◀]/[▶] buttons simultaneously to select the first Voice in the Voice group.

### Voice display



This indicates the current position in the Voice group.

## Song display (page 44)

1. Press the [DEMO/SONG] button to call up the Song category list.

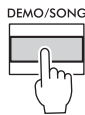

2. Use the [▲]/[▼] buttons to select a Song category.

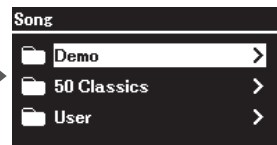

Press [▶] to select a Song category.  
Press [◀] to return.

## Detailed settings (Menu) display (page 94)

1. Press the [MENU] button repeatedly to select the desired menu.

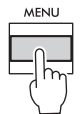

2. Use the [▲]/[▼] buttons to select a parameter of the current menu.

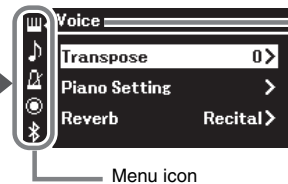

Menu name

Note that the hierarchy depth differs depending on the selected parameter.

Menu icon

You can also select the desired menu by using these alternate steps:

1. Press the [MENU] button once to call up the detailed setting display.

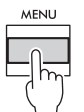

2. Press the [◀] button to highlight the menu icon, and then use the [▲]/[▼] buttons to select the desired menu.

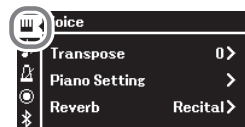

**Voice display:** For selecting the Voice (the sound when playing the keyboard).

**Song display:** For selecting the Song to playback on this instrument.

**Detailed setting display:** For making detailed settings for about the keyboard performance, such as Voice, or Song playback, etc. (page 94)

#### NOTE

Depending on the instrument's color, the display background is white and the characters and other marks are black.

### 3. Use the [▲]/[▼] buttons to select a Song.



Press [▶] to select a Song.  
Press [▲] to return.

When this is shown here,  
you can scroll through the  
display vertically.

### 4. Press [PLAY/PAUSE] button to playback the Song.

Use the [◀] or [▶] buttons to select the previous or next bars.

#### Song display



#### Adjusting the value on the slider pop-up window

### 3. Use the [◀]/[▶] buttons to adjust the value, press the [EXIT] button to close the pop-up window.

To reset the default value, press the [◀] and [▶] buttons simultaneously.

Press [▶] to detailed settings.  
Press [EXIT] to return to the  
previous display.

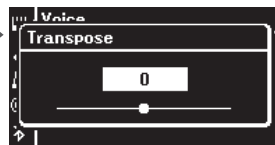

Press [▶] to detailed settings.  
Press [◀] to return.

#### Selecting a value from a list

### 3. Use the [▲]/[▼] buttons or the [▶] button to select a setting.

Press the [◀] button to return to the previous display.

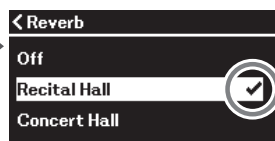

A checkmark is shown at  
the right of the selection.

# Playing Various Musical Instrument Sounds (Voices)

You can select and play other musical instrument sounds (Voices), such as piano, organ, or stringed instruments.

## Selecting Voices

The Voices of the instrument are conveniently divided into groups of instrument types. Select a desired Voice and play the piano. You can also select a Voice from the XG Voices. For instructions, refer to page 21.

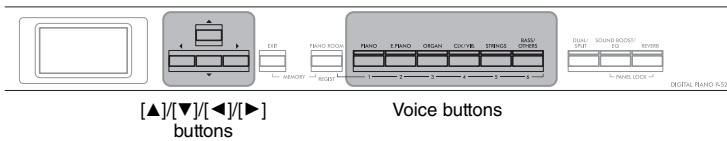

1. Press one of the Voice buttons to select the desired Voice group.

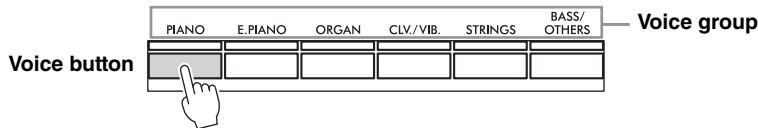

2. Use the [◀] or [▶] button to select the desired Voice. Press the [◀] and [▶] buttons simultaneously to select the first Voice in the Voice group.

### Voice display



The Voice display of the currently selected Voice appears.

This indicates the current position in the Voice group.

3. Play the keyboard.

### NOTE

To hear and experience the characteristics of the Voices, listen to the Demo Songs for each Voice (page 22) or refer to "Preset Voice List" on page 110.

### NOTE

For information about the Voices, refer to the "Preset Voice List" (page 110).

### NOTE

You can specify the Touch Sensitivity (how the sound responds to the way you play the keys). For details, refer to page 36.

### Selecting XG Voices

XG Voice is for playing the XG (page 7) format compatible Song data. After the Voice display is called up, select a Voice from the XG Voices, following the instructions below.

1. Press the [BASS/OTHERS] button twice to call up the XG Voice group list display.



2. Use the [▲]/[▼] buttons to select one of the XG Voice groups, then press the [▶] button.

#### XG Voice group list display



When this is shown here, you can scroll through the display vertically.

3. Use the [▲]/[▼] buttons to select the desired XG Voice, then press the [▶] button.

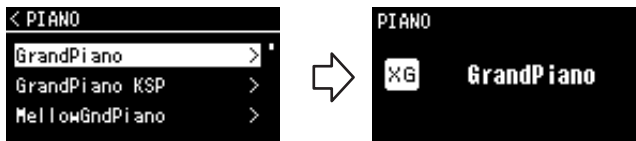

To return from the XG Voice name display to the XG Voice list display, press the [▲] button.

To return from the XG Voice list display to the XG Voice group list display (step 2), press the [◀] button.

\*For details on XG Voices, refer to the "XG Voice list" in the Data List on the website (see page 6).

## Listening to the Voice Demos

For each Voice group, the instrument contains several Demo recordings that showcase the special characteristics of the corresponding Voices. For information about the Voices which feature Demos that can be played back, refer to the Preset Voice List on page 110.

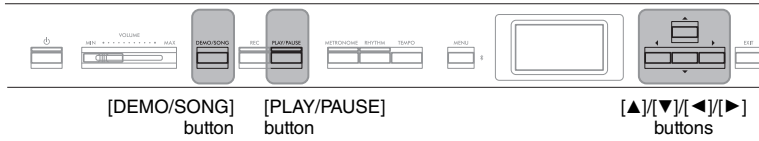

1. Press the [DEMO/SONG] button to call up the Song list display.



2. Use the [▲]/[▼] buttons to select "Demo," and then press the [▶] button to call up the next display.
3. Use the [▲]/[▼] buttons to select the desired Voice Demo, and then press the [▶] button to call up the "Demo" display.

The currently selected Voice Demo name is shown in the display.



4. Press the [PLAY/PAUSE] button to start playback.
5. Press the [PLAY/PAUSE] button again to stop playback.  
The Piano Demo stops automatically when Piano Demo playback reaches the end.

### Selecting Other Demos

Press the [▲] button to return to the Song list display, then repeat steps 3–4 of this section. This operation is available even during playback.

#### NOTE

Recording operations cannot be used during Voice Demo playback.

## Customizing the Sound and the Touch Response of Piano Voices (Piano Room)

The Piano Room function is for those who want to simply, conveniently, and fully enjoy playing the instrument as a piano. No matter what Voice or other settings you've made, you can instantly call up the optimum settings for piano performance with a single button press. Try creating a custom piano sound by adjusting the various parameters, such as lid position, string resonance, damper resonance, touch response and so on.

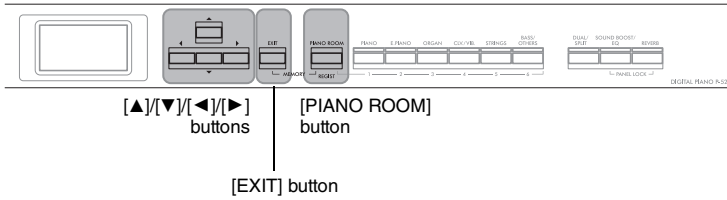

1. Press the [PIANO ROOM] button to call up the Piano Room display.

Piano Room display



2. Press the [▲]/[▼] buttons to select items (page 24).
3. Press the [◀]/[▶] buttons to change the settings (page 24).
4. Press the [EXIT] button to exit from the Piano Room display.









### NOTE

Voices in the Piano group are those contained in the "Piano" category in the Preset Voice List (page 110). For details about selecting Voices, refer to page 20.



### NOTE

- If a Voice other than one in the Piano group is selected, pressing the [PIANO ROOM] button changes it to "CFX Grand."
- Pressing the [PIANO ROOM] button disables the Dual/Split/Duo functions.

## Parameters you can set in the Piano Room

Item	Icon	Descriptions	Default settings	Setting range
Lid Position		Recreates the differences in sound depending on how high the (virtual) grand piano lid is opened.	Full	Full, Half, Close
Brightness		Adjusts the brilliance of sound.	Differs depending on the Voice.	0 – 10
Touch		Determines how the sound responds to your playing strength. You should adjust this setting according to the specific Voice you're playing or the particular Song you're performing, as desired.	Medium	Soft2, Soft1, Medium, Hard1, Hard2, Fixed
Reverb		Determines the Reverb type which is applied to all the entire sound including the keyboard performance, Song playback and MIDI data input from an external MIDI device.	Differs depending on the Voice.	Refer to the Reverb Type List (page 26)
Reverb Depth		Adjusts the Reverb depth. When "Reverb" is set to "off" or a value of "0," no effect is produced.	Differs depending on the Voice.	0 – 40
Master Tune		Fine tunes the pitch of the entire instrument. This function is useful when you play this instrument along with other instruments or CD music.	A3 = 440.0 Hz	A3 = 414.8 Hz – 466.8 Hz (approx. 0.2 Hz steps)
VRM	 	<p>Turns the VRM effect on/off. For information about the VRM function, refer to page 25.</p> <p><b>Listening to the VRM Demo</b>                      Press the [PLAY/PAUSE] button while this display is open to play back the VRM Demo Song. You can hear the Demo Song with and without the effect (VRM on or off).</p> <p>The five parameters below can be set when "VRM" is On.</p>	On	On, Off
Damper Resonance		Determines the depth of the string resonance effect which is applied when the damper pedal is pressed.	5	0 – 10
Damper Noise		 <p>Turns the Damper Noise produced by the VRM function On/Off. For details on damper noise, refer to page 25. This function will be disabled when "Damper Resonance" is set to "0."</p>	On	On, Off
String Resonance		Determines the depth of the string resonance effect which is applied when a note on the keyboard is pressed.	5	0 – 10
Duplex Scale Resonance		 <p>Adjusts the sympathetic vibrations of the duplex scaling resonance effect in VRM. For details about duplex scaling, refer to page 25.</p>	5	0 – 10
Body Resonance		Adjusts the resonance of the piano itself (the soundboard, the sides, the frame and so on) in VRM.	5	0 – 10



Item	Icon	Descriptions	Default settings	Setting range
Grand Expression		<p>Selects the type of the Grand Expression Modeling effects, which simulates the physical sound transitions of an actual piano. When this feature is set to "Dynamic," you can control extremely subtle nuances in the performance and sound by changing your playing strength or touch. When set to "Static," the nuances are generally fixed. For details about Grand Expression Modeling, refer to the below.</p> <p><b>NOTE</b> Grand Expression Modeling is effective only for the Voices of "CFX Grand" and "Bösendorfer."</p> <p><b>Listening to the Demo</b> Press the [PLAY/PAUSE] button while this display is open to play back the Demo Song of this function. You can listen to the Demo song with "Dynamic" or "Static."</p> 	Dynamic	Dynamic, Static
Half Pedal Point		<p>Specify the point to which you must depress the pedal before the effect of "Sustain (Continuous)" begins to be applied. This setting applies only to the "Sustain (Continuous)" effect (page 17) that is assigned to the right pedal connected to the [PEDAL UNIT] jack or the foot pedal/footswitch connected to the [AUX PEDAL] jack.</p>	0	-2 (effective with the shallowest press) - 0 - +4 (effective with the deepest press)

**NOTE**

- If you wish to keep the Piano Room settings even after turning off the power, set "Voice" and "Other" in the "Backup" setting to "On." For details, refer to page 90.
- The items listed above can also be set in the "Voice" menu (page 95) or the "System" menu (page 103). When you change these settings in the Piano Room display, the settings in the menu displays will also be changed. Conversely, changing the settings in the menu displays will also change the settings in the Piano Room display.
- To restore the default value, press the [◀] and [▶] buttons simultaneously while the setting value is shown.

## Glossary of terms

Term	Description
Damper Noise	Damper noise is the sound made on an acoustic piano when the damper pedal is pressed. The damper noise changes in tone and volume depending on how quickly the damper pedal is pressed down. Pressing the damper pedal slowly will make a quieter sound when the damper heads are released from the strings. Pressing the damper pedal with force will transmit the vibrations to the strings, which adds a lower and louder sound.
Duplex Scale	Duplex scaling is a stringing method for pianos that uses extra, un-struck strings in the upper octaves to enhance the tone. These strings sympathetically vibrate with other strings in an acoustic piano, resonating with overtones, and adding richness, brilliance and complex color to the sound. Since the dampers do not touch them, they will continue sounding even after you release your hands from the keyboard.
Grand Expression Modeling	On an actual acoustic piano, subtle changes in the sound can be produced by changing your playing touch from when you press a key to when you release it. For example, when you press a key all the way to its bottom, the key hits the keybed underneath and the noise reaches the strings, changing the sound slightly. Furthermore, the tone when the damper is lowered onto strings to mute the sound is changed by how quickly you release the key. Grand Expression Modeling technology recreates these subtle changes in the sound that respond to your touch. This allows you to add accents by playing strongly or add resonance by playing softly to produce superbly expressive sound. A crisp tone can be heard when playing staccato as well as a lingering sound produced when releasing the keys slowly.
VRM (Virtual Resonance Modeling)	The VRM (Virtual Resonance Modeling) function uses sophisticated physical modeling to simulate the actual string resonance sound that occurs when the damper pedal on a real piano is pressed or keys are played and held. On an actual acoustic piano, if you press the damper pedal and play a key, not only does the string of the pressed key vibrate, it also causes other strings and the soundboard to vibrate, each influencing the rest and creating a rich and brilliant resonance that sustains and spreads. The VRM (Virtual Resonance Modeling) technology featured in this instrument reproduces the complicated interaction of both string and soundboard resonance faithfully using a virtual musical instrument (physical modeling), and makes the sound more like a real acoustic piano. Since instantaneous resonance is made at the moment according to the state of the keyboard or pedal, you can vary the sound expressively by changing the timing of your pressing the keys, and the timing and depth of your pressing the pedal.

## Enhancing and Customizing the Sound

Applying the following effects gives you greater and richer expressive capabilities.

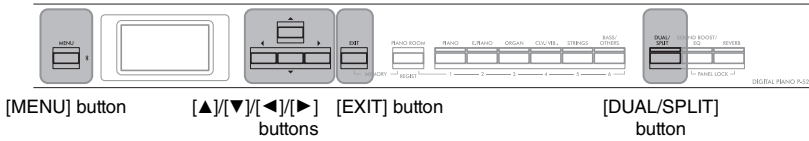

## Adding reverberation to the Sound (Reverb)

Adding reverberation to the Sound enables you enjoy the realistic feeling of playing in a concert hall. When you select a Voice, the optimum Reverb Type is automatically selected, but you can also select it yourself. The Reverb type selected here is applied to the entire sound, including the keyboard performance, Song playback and MIDI data input from an external device.

1. Press the [REVERB] button to call up the “Reverb” display. The Reverb type for Voices in the Piano group can also be set in the Piano Room display (page 24).

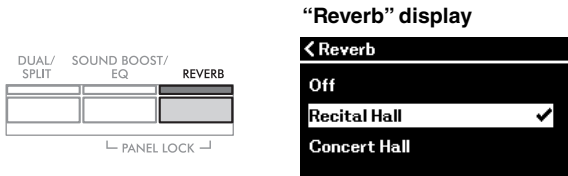

2. Use the [▲]/[▼] buttons to select the Reverb type.

### Reverb Type List

Reverb type	Effect
Off	No effect
Recital Hall	Simulates clear reverberation in a mid-sized hall suitable for piano recital.
Concert Hall	Simulates brilliant reverberation in a large hall for public orchestra performances.
Chamber	Simulates the elegant reverberation in a small room suitable for chamber music.
Room	Simulates the soft reverberation of a smaller performance space, such as a room or lounge.
Cathedral	Simulates the solemn reverberation in a high-ceiling stone-made cathedral.
Club	Simulates the lively reverberation in a jazz club or a small bar.
Plate	Simulates the bright sound of vintage reverb equipment used in recording studios.

**Default setting:** Differs depending on the Voice or Voice combination.

You can adjust the Reverb depth for the selected Voice from the “Voice” menu: “Voice Edit” → “Reverb Depth” (page 96).

3. Press the [EXIT] button to exit from the “Reverb” display.

## Adding Chorus effect to the Sound

The Chorus adds warmth and spaciousness to the sound. The ideal Chorus type is automatically selected whenever you select a Voice, but you can select any of the available Chorus types. This setting is applied to the entire sound, including the keyboard performance, Song playback and MIDI data input from an external device.

1. Press the [MENU] button repeatedly to call up the “Voice” menu display.



2. Use the [▲]/[▼] buttons to select “Chorus,” and then press the [▶] button.

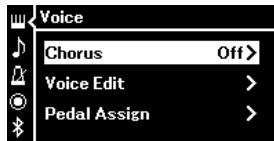

3. Use the [▲]/[▼] buttons to select the Chorus type.

### Chorus Type List

Chorus type	Effect
Off	No effect
Chorus	Adds a rich, spacious sound.
Celeste	Adds swell and a spacious sound.
Flanger	Adds swell effects similar to the sound of an ascending or descending jet plane.

You can adjust the Chorus depth for the selected Voice from the “Voice” menu: “Voice Edit” → “Chorus Depth” (page 96).

4. Press the [EXIT] button to exit from the “Chorus” display.

**Default setting:** Differs depending on the Voice or Voice combination.

#### NOTE

When you want to apply the Chorus effect to a Voice whose Chorus type is set to off by default, set the Chorus type to something other than “Off,” then set the Chorus depth value as desired (greater than “0”).

## Applying Effects

This instrument features a wide variety of Effects, letting you apply enhancements such as Echo or Tremolo to the selected Voice for your keyboard performance.

1. Select the target Voice.
2. Press the [MENU] button repeatedly to call up the “Voice” menu display, and then use the [▲]/[▼] buttons to select “Voice Edit.”

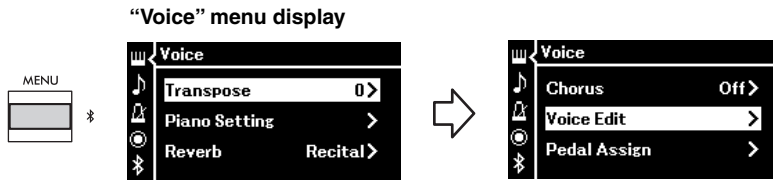

3. Use the [▲]/[▼] buttons to select “Effect,” and then press the [▶] button.

“Voice Edit” display

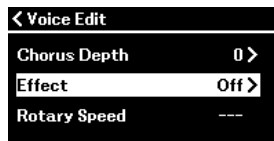

4. Use the [▲]/[▼] buttons to select the Effect type.

### Effect Type List

Effect type	Effect
Off	No effect.
DelayLCR	Delay applied at left, center, and right positions.
DelayLR	Delay applied at left and right positions.
Echo	Echo-like delay
CrossDelay	Left and right delays cross each other in alternation.
Symphonic	Adds a rich and deep acoustic effect.
Rotary	Adds the vibrato effect of a rotary speaker.
Tremolo	The volume level changes in rapid cycles.
VibeRotor	The vibrato effect of a vibraphone.
AutoPan	The sound pans left to right and back and forth.
Phaser	The phase changes periodically, swelling the sound.
AutoWah	The center frequency of the wah filter changes periodically.
Distortion	Distorts the sound.

**Default setting:**

Differs depending on the Voice or Voice combination.

5. Press the [EXIT] button to exit from the “Effect” display.

## Playing Two Voices Simultaneously (Dual)

Two Voices can be played simultaneously. You can create warm and richly textured Voices by using Voices from different groups simultaneously in a layer, or by using Voices in the same group.

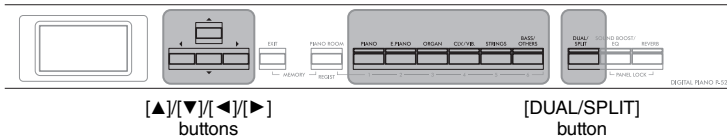

1. To enter the Dual mode, press the [DUAL/SPLIT] button once.

The [DUAL/SPLIT] button lights up.



The Voice which is displayed at top is Voice 1, and the one at bottom is Voice 2.

2. Select the Voices for layering.
  - 2-1. Use the [▲]/[▼] buttons to highlight 1 (Voice 1) in the display.
  - 2-2. Press one of the Voice buttons to select the desired Voice group, and then use the [◀]/[▶] button to select the desired Voice (page 20).
  - 2-3. Use the [▲]/[▼] buttons to highlight 2 (Voice 2), and then select a Voice according to step 2-2.
3. Play the keyboard.
4. To exit from the Dual mode, press the [DUAL/SPLIT] button repeatedly until its lamp turns off.

### NOTE

You can also enter the Dual mode by pressing the two Voice buttons simultaneously.

## Splitting the Keyboard Range and Playing Two Different Voices (Split Mode)

Split mode enables you to play two different Voices on the keyboard—one with your left hand and another with your right.

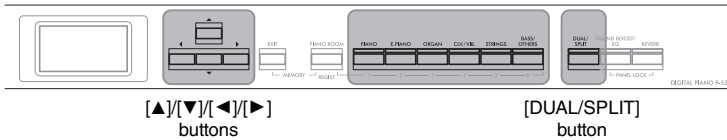

### 1. To enter the Split mode, press the [DUAL/SPLIT] button twice.

The [DUAL/SPLIT] button lights.



The Voice which is displayed at top is Voice R, and the one at bottom is Voice L.

### 2. Select a Voice for the right-hand area and left-hand area.

The border between the right- and left-hand ranges is referred to as "Split Point." The Split Point key (F#2 as default) is included in the left-hand range.

- 2-1. Use the [▲]/[▼] buttons to highlight **[R]** (Voice R) in the display.
- 2-2. Press one of the Voice buttons to select the desired Voice group, and then use the [◀]/[▶] button to select the desired Voice (page 20).
- 2-3. Use the [▲]/[▼] buttons to highlight **[L]** (Voice L), and then select a Voice according to step 2-2.

### 3. Play the keyboard.

#### Changing the Split Point

You can change the Split Point from the default setting "F#2" to any other key. While in the Split mode, hold down the [DUAL/SPLIT] button, and press the key you wish to assign as the Split Point.

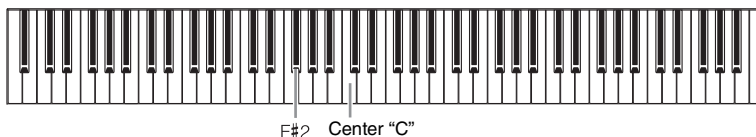

#### NOTE

The Split Point can also be set via the "System" menu display: Press the [MENU] button repeatedly to call up the "System" menu display → "Keyboard" → "Split Point" (page 104).

4. To exit from the Split mode, press the [DUAL/SPLIT] button repeatedly until its lamp turns off.

## Using Dual and Split Simultaneously

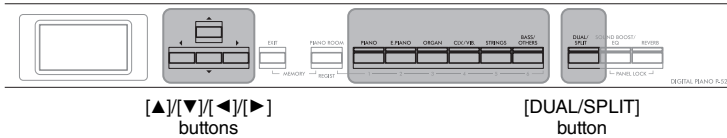

1. To use both the Dual and Split modes simultaneously, press the [DUAL/SPLIT] button three times. The [DUAL/SPLIT] button lights.



The Voice which is displayed at top is Voice R1, and the one in the middle is Voice R2, and the one at bottom is Voice L.

2. Select the Voices for layering and for the left-hand area.
  - 2-1. Use the [▲]/[▼] buttons to highlight [R1] (Voice R1) in the display.
  - 2-2. Press one of the Voice buttons to select the desired Voice group, and then use the [◀]/[▶] button to select the desired Voice (page 20).
  - 2-3. Use the [▲]/[▼] button to highlight [R2] (Voice R2) or [L] (Voice L), and then select Voices according to step 2-2.
3. Play the keyboard.
4. To exit from the Dual and Split modes, press the [DUAL/SPLIT] button repeatedly until its lamp turns off.

**NOTE**

The specified Split Point key is included in the left-hand range.

**NOTE**

For the information on setting the Split Point, refer to page 30.

## Playing Duo

This function allows two different players to play the instrument, one on the left and the other on the right. This is convenient for practicing duets over the same octave range.

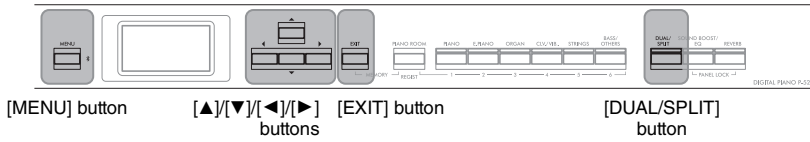

1. Press the [MENU] button repeatedly to call up the “System” menu display, and then select the highlighted item in each display as illustrated below.

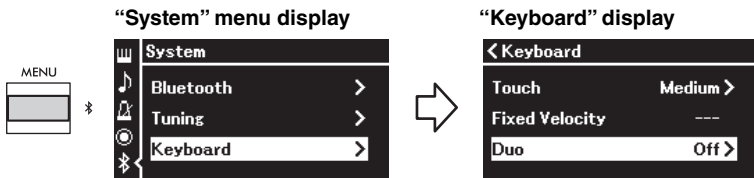

- 1-1. Use the [▲]/[▼] buttons to select “Keyboard.”
- 1-2. Press the [▶] button to call up the next display.
- 1-3. Use the [▲]/[▼] buttons to select “Duo.”
- 1-4. Press the [▶] button to select “On.”

The keyboard is divided into two sections, with the E3 key as the Split Point.

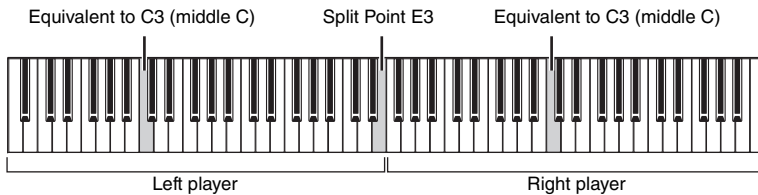

When using the separately sold pedal unit, the pedal function changes as follows.

Right Pedal	Damper pedal for the right-player range
Center Pedal	Damper pedal for both the right-player and left-player ranges
Left Pedal	Damper pedal for the left-player range

### NOTE

- When Duo is on, the Dual (page 29), Split (page 30), and the VRM (page 24) functions are turned off.
- When the Duo - Type (page 104) is set to “Separated,” the Reverb Depth (page 96) is set to 0 and the Binaural Sampling function (page 14) is turned off.

### NOTE

- The specified Split Point key is included in the left-hand range.
- The Split Point can be changed. For details on setting the Split Point, refer to page 30.



## 2. Press the [EXIT] button to call up the Voice display.

When Duo is on, the [Duo] indication is shown on the Voice display. Press one of the Voice buttons to select the desired Voice as necessary (page 20).



## 3. Play the keyboard.

By default, the sound of the left player range is emitted from the left speaker, the sound of the right player range is emitted from the right speaker.

## 4. Press the [DUAL/SPLIT] button to exit from the Duo mode.

### NOTE

The sounds played by both Right and Left players can be output through both speakers, with a natural balance of sound. You can set this from the "System" menu: "Keyboard" → "Duo - Type" (page 104).

## Transposing the Pitch in Semitones (Transpose)

You can shift the pitch of the entire keyboard up or down in semitone intervals to facilitate playing in difficult key signatures, and to let you easily match the pitch of the keyboard to the range of a singer or other instruments. For example, if you set this parameter to “5”, playing key C produces pitch F. In this way, you can play the F major song as if it were in C major.



1. Press the [MENU] button repeatedly to call up the “Voice” menu display. Select “Transpose,” and then press the [▶] button.



2. Set the Transpose amount by using the [◀]/[▶] buttons. To reset the parameter to the default setting, press the [◀] and [▶] buttons simultaneously.



3. Press the [EXIT] button to close the “Transpose” display.

**Default setting:** 0  
**Setting range:** -12 (-1 octave) – 0 (normal pitch) – +12 (+1 octave)

**NOTE**

The setting made here does not affect Song playback. If you want to transpose Song playback, use the Transpose Song parameter in the “Song” menu (page 98).

**NOTE**

Your keyboard performance data will be transmitted with the transposed note numbers while MIDI note numbers received from an external MIDI device or computer will not be affected by the Transpose setting.

## Fine Tuning the Pitch (Master Tune)

You can fine-tune the pitch of the entire instrument. This function is useful when you play this instrument along with other instruments or recorded music.

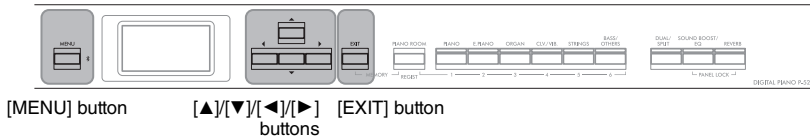

1. Press the [MENU] button repeatedly to call up the “System” menu display. Select “Tuning” by using the [▲]/[▼] buttons and then press the [▶] button.

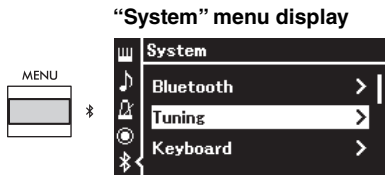

2. Use the [▲]/[▼] buttons to select the “Master Tune,” then press the [▶] button.

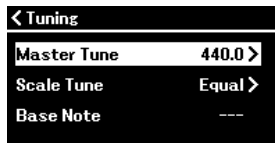

3. Set the tuning value by using the [◀]/[▶] buttons.  
To reset the value to the default setting (A3=440.0Hz), press the [◀]/[▶] buttons simultaneously.



4. Press the [EXIT] button to close the “Master Tune” display.

**Default setting:** A3=440.0Hz  
**Setting range:** A3=414.8Hz – 440.0Hz – 466.8Hz (in approximately 0.2 Hz increments)

**NOTE**

- If you change the tuning value here, the value in the Piano Room display (page 24) is also changed.
- These settings will not be applied to the Drum Kit Voices or Audio Song. Also, these settings will not be recorded to a MIDI Song.

## Changing the Touch Sensitivity (Touch)

You can determine how the sound responds to your playing strength. This setting does not change the weight of the keyboard.

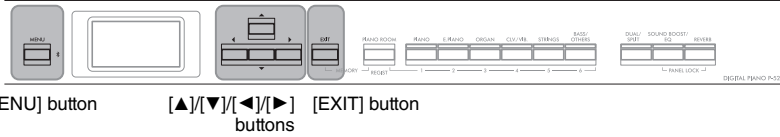

1. Press the [MENU] button repeatedly to call up the “System” menu display. Select “Keyboard” by using the [▲]/[▼] buttons, and then press the [▶] button.

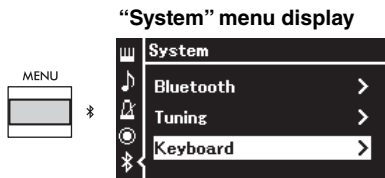

2. Select “Touch” by using the [▲]/[▼] buttons, and then press the [▶] button.

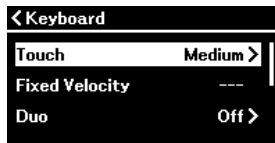

3. Use the [▲]/[▼] buttons to determine the touch sensitivity.



### Touch Sensitivity list

Soft 2	Produces relatively high volume even with light playing strength.
Soft 1	Produces high volume with moderate playing strength.
Medium	Standard touch sensitivity.
Hard 1	Requires moderately strong playing for high volume.
Hard 2	Requires strong playing to produce high volume.
Fixed	No touch response. The volume level will be the same regardless of how hard you play the keys.

4. Press the [EXIT] button to exit from the “Touch” display.

### NOTE

When playing with Piano Voices, you can also determine the touch sensitivity in the Piano Room display. For details, refer to “Parameters you can set in the Piano Room” on page 24.

**Default setting:** Medium

### NOTE

- If you change the touch sensitivity here, the setting in the Piano Room display (page 24) is also changed
- The setting here will not be recorded to a MIDI Song nor be transmitted as MIDI messages.
- The touch sensitivity settings may have no effect with Organ or Harpsichord Voices.

## Boosting the Overall Sound (Sound Boost)

By using the Sound Boost function when playing along with other instruments, you can raise the volume and enhance the presence of your performance without losing any of the expressive range. This function is particularly useful when you want all the notes you play—both loud and soft—to be clearly audible.

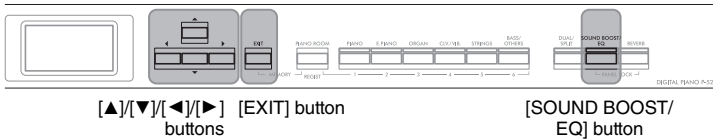

1. Press the [SOUND BOOST/EQ] button repeatedly to call up the “Sound Boost” display, and then press the [▲] button to highlight “On/Off.”

Default setting: Off

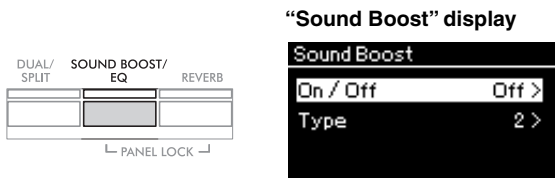

2. Press the [▶] button to turn on the Sound Boost function. The [SOUND BOOST/EQ] button lights.
3. Press the [▼] button to highlight “Type.”
4. Press the [▶] button to call up the “Type” display, then use the [▲]/[▼] buttons to select the Sound Boost type.

Default setting: 2

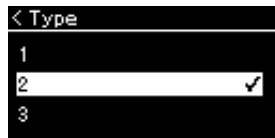

### Sound Boost type list

1	Producing smooth dynamics, this type is ideal for solo performances of energetic songs.
2	This type produces a smoother, clearer sound than Type 1, making it the perfect choice when singing and playing at the same time.
3	In addition to brighter, more-powerful sound than Type 2, this type also has a clearer attack — ideal when performing as part of a band.

5. Press the [EXIT] button to exit from the “Type” display.

## Adjusting the Sound (Master EQ)

The EQ (Equalizer) processes the sound by dividing the frequency spectrum into multiple bands, allowing you to boost or cut them as required to tailor the overall frequency response and provide optimum sound when listening through the instrument’s internal speaker, or headphones, etc.

This instrument possesses a three-band digital EQ. You can select one of the three preset EQ types in the “Master EQ” display. You can even create your own custom EQ settings by adjusting the frequency bands, and save the settings to the User Master EQ.

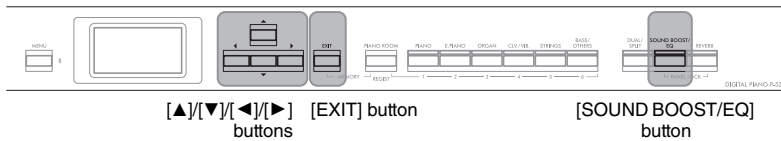

### Selecting the Master EQ type

1. Press the [SOUND BOOST/EQ] button repeatedly to call up the “Master EQ” display.



Default setting: Flat

2. Use the [▲]/[▼] buttons to select the Master EQ type.

#### Master EQ type list

Flat	Flat, unprocessed EQ settings.
Bright	EQ settings providing bright sound.
Mellow	EQ settings providing mellow sound.
User	Your own custom EQ settings saved in “Setting the User Master EQ” (page 39).

3. Press the [EXIT] button to exit from the “Master EQ” display.

## Setting the User Master EQ

1. Press the [▼] button to select “User” in the “Master EQ” display, then press the [▶] button to call up the User display in which the three bands can be boosted or cut.

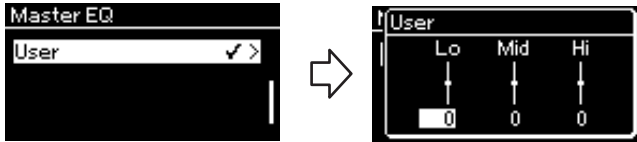

2. Use the [◀]/[▶] buttons to select a band, then use [▲]/[▼] buttons to boost or cut it.

To reset the setting to the default, press the [▲]/[▼] buttons simultaneously.



3. Press the [EXIT] button to close the “User” display.

**Default setting:** 0 dB  
**Setting range:** -6 dB – 0 – +6 dB

## Locking the Front Panel

This instrument features a convenient Panel Lock function that allows you to temporarily disable the front panel buttons to prevent them being operated unintentionally while performing.



### 1. Press the [PANEL LOCK] buttons simultaneously to lock the front panel.

The Voice display appears on the instrument's display, and the lock icon is shown at the lower right on the display.

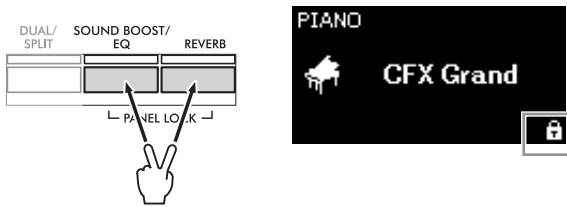

All front panel buttons with the exception of the [⏻] (Standby/On) switch and [VOLUME] slider will be disabled.

### 2. Press the [PANEL LOCK] buttons simultaneously again to unlock the front panel.

#### NOTE

- It is impossible to lock the front panel during Song playback and recording.
- When the front panel is locked during playback of the metronome, rhythm, and Song, playback cannot be stopped until the panel is unlocked.
- When the front panel is locked, it is impossible to switch between Song playback/pause by using the Aux pedal function (page 104).
- Even if the front panel is locked, when the Auto Power Off function (page 13) is on, the power is automatically turned off.



## Using the Metronome

The instrument has a built-in metronome (a device that keeps an accurate tempo)—a convenient tool for practice.

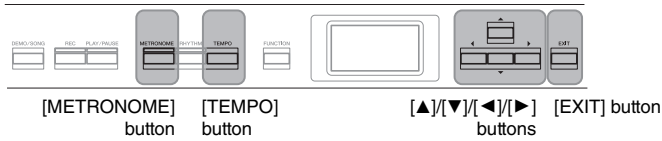

### 1. Press the [METRONOME] button to start the metronome.

This calls up the “Tempo” display, from which you can adjust the tempo.

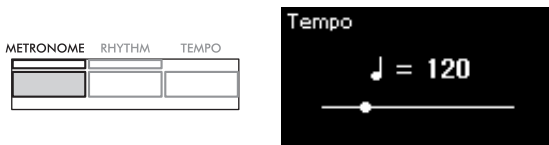

For information on setting the time signature, refer to page 42. You can set the metronome volume, BPM and so on from the “Metronome/Rhythm” menu display (page 101).

### 2. Press the [METRONOME] button again to stop the metronome.

To exit from the “Tempo” display, press the [EXIT] button.

#### BPM

You can determine whether the note type of the tempo indication is affected by the metronome time signature (page 101) or not.

## Adjusting the Tempo

### 1. Press the [TEMPO] button to call up the “Tempo” display.



### 2. Use the [◀]/[▶] buttons to adjust the tempo.

To reset the tempo to the default setting, press the [◀] and [▶] buttons simultaneously.

### 3. Press the [EXIT] button to exit from the Tempo display.

**Default setting:** 120

**Setting range:** Depends on the time signature (page 42).

## Setting the metronome time signature

1. Press the [MENU] button repeatedly to call up the “Metronome/Rhythm” menu display. Select the “Time Sig.”, and then press the [▶] button.

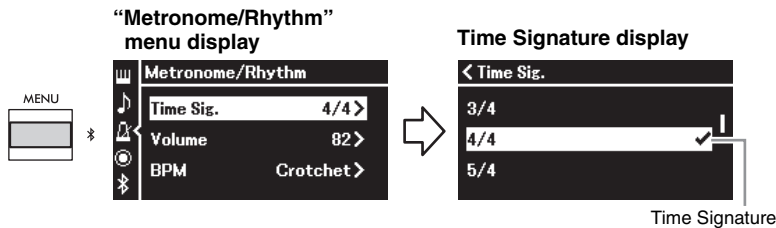

2. Use the [▲]/[▼] buttons to select the desired time signature.

**Setting range:** 2/2, 3/2, 1/4, 2/4, 3/4, 4/4, 5/4, 6/4, 7/4, 3/8, 6/8, 7/8, 9/8, 12/8

**Default setting:** 4/4 (Selecting a MIDI Song will change the tempo value to that specified in the selected MIDI Song data.)

### Tempo indication and Setting range

When pressing the [TEMPO] button, the tempo is displayed as “note type=xxx” (For example: ♩ =120). Selecting the Time Signature changes the available parameters as follows.

Note type	Time Signature	Setting range
♩ Half note	2/2, 3/2	3 – 250
♩ Quarter note	1/4, 2/4, 3/4, 4/4, 5/4, 6/4, 7/4	5 – 500
♩ Dotted quarter note	6/8, 9/8, 12/8	4 – 332 (even numbers only)
♩ Eighth note	3/8, 7/8	10 – 998 (even numbers only) and 999

\* When the tempo value of the selected MIDI Song is outside the setting range on the instrument, the value will be changed to fit within the setting range.

\* Note type will be fixed to quarter note as long as the “BPM” parameter in the “Metronome/Rhythm” menu display is set to “Crotchet” regardless of the Time Signature you set.

You can playback the metronome with a Bell sound on the first beat of each measure according to the selected Time Signature.

For details, refer to “Bell” in the “Metronome/Rhythm” menu (page 101).

3. Press the [EXIT] button to exit from the “Metronome/Rhythm” menu display.

### Note type

The length of one beat

### Metronome detailed settings

You can set the metronome volume, BPM and so on from the “Metronome/Rhythm” menu display (page 101).

# Playing the Keyboard along with Rhythm Playback

You can select a Rhythm from a variety of musical genres, such as Pops and Jazz, and play along with it. Refer to “Rhythm List” on page 112.

For this instrument, Rhythm consists of drums and bass accompaniment.

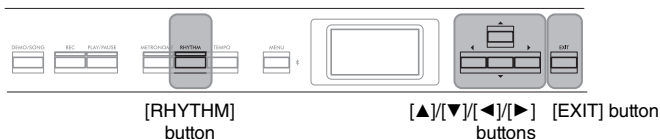

## 1. Press the [RHYTHM] button to start Rhythm playback.

Intro playback starts followed by the Rhythm playback.



### To set the Intro/Ending on or off:

“Intro” and “Ending” allow you to vary the arrangement of the accompaniment. You can set “Intro” and “Ending” on/off via “Intro” or “Ending” in the “Metronome/Rhythm” menu display (page 101).

## 2. Use the [◀]/[▶] buttons to call up the desired Rhythm.

For details on the available Rhythms, refer to the Rhythm List (page 112).

## 3. Play the keyboard along with Rhythm playback.

The instrument will automatically create appropriate accompaniment bass sound while you play, based on the chords you play.

### To set the bass sound on/off:

The default setting of the bass sound is “On.”

If you don’t want to have the bass accompaniment sound, set it to “Off.”

You can set “Bass” in the “Metronome/Rhythm” menu display (page 101).

## 4. To stop Rhythm playback, press the [RHYTHM] button again.

The Rhythm will automatically stop after the Ending is played.

## 5. Press the [EXIT] button to exit from the “Rhythm” display.

### About the Rhythm Tempo

- The Rhythm tempo is equivalent to that set for the Metronome (page 41).
- Although you set the Rhythm tempo, selecting a MIDI Song will change the tempo value to that specified in the selected MIDI Song data.
- When you press the [TEMPO] button to call up the “Tempo” display to change the Rhythm tempo, during Rhythm playback, press the [EXIT] button to return to the “Rhythm” display from the “Tempo” display.

### Detailed Settings for the Rhythm

From the “Metronome/Rhythm” menu display (page 101), you can set detailed parameters, such as Rhythm volume and Sync Start, with which pressing a key will start Rhythm playback.

### NOTE

The “Rhythm” display cannot be called up during the Song playback or recording.

### NOTE

- Some arrangements may not be suitable for use with this feature.
- 9th, 11th and 13th chords cannot be played.
- For details on how to play chords, refer to commercially available chord books.

# Playing and Practicing Songs

---

This instrument can play Preset Songs, Songs you recorded on this instrument, or commercially available Songs. In addition to listening to these Songs, you can play the keyboard as the Song plays back. There are two kinds of Songs that can be recorded and played back on this instrument: MIDI Songs and Audio Songs.

## • MIDI Song

A MIDI Song is comprised of your keyboard performance information and is not a recording of the actual sound itself. The performance information refers to which keys are played, at what timing, and at what strength—just as in a musical score. Based on the recorded performance information, the tone generator outputs the corresponding sound. A MIDI Song uses a small amount of data capacity in comparison to an Audio song, and allows you to easily change aspects of the sound, such as Voices used, etc.

## • Audio Song

An Audio Song is a recording of the performed sound itself. This data is recorded in the same way as that used with voice recorders, etc. This data can be played with a portable music player, etc., allowing you to easily let other people hear your performance.

Availability of functions differs between MIDI Songs and Audio Songs. In this chapter, the following icons indicate whether or not the explanation applies to MIDI Songs or Audio Songs individually.

**Example:**  

Indicates explanation applies only to MIDI Songs

You can play back the following types of Songs in this instrument.

- Voice Demo Songs (Voice Demo).
- Preset Songs: 50 classical Preset Songs (“50 Classics”)
- Your own recorded Songs (see page 54 for instructions on recording)
- Commercially available MIDI Song data: SMF (Standard MIDI File)  
The maximum size for playback on this instrument is approx. 500 KB per single MIDI Song.
- Commercially available Audio Song data: Wav (file extension = .wav with 44.1 kHz sample rate, 16-bit resolution, stereo, and maximum 80 minutes length)

## Playback of Songs

MIDI | Audio

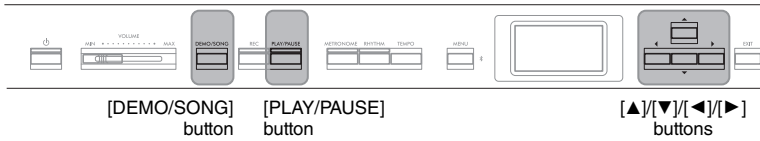

1. If you want to play back a Song in a USB flash drive, connect the USB flash drive containing Song data to the [↔] (USB TO DEVICE) terminal beforehand.
2. Press the [DEMO/SONG] button to call up the Song List display, then select the desired category using [▲]/[▼] buttons.

Select the desired one from “50 Classics,” “User” or “USB” referring to the category descriptions below.

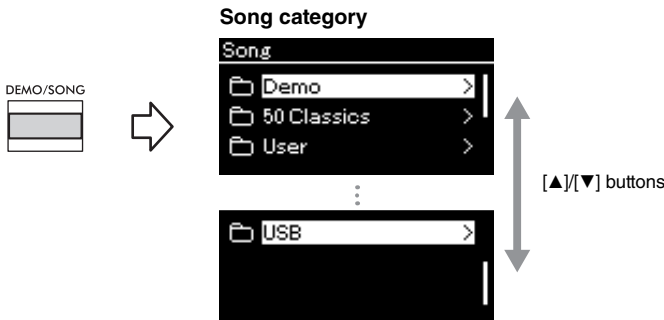

<b>Demo</b>	Voice Demos let you experience the characteristics of the Voices (MIDI Song). Refer to page 22 for how to play back the Demo. For Song names, refer to the “Voice Demo List” on page 111.
<b>50 Classics</b>	50 classical Preset Songs (MIDI Songs). For details, refer to the “Song List” on page 112.
<b>User</b>	MIDI Songs which have been recorded and saved to the instrument by using the Recording function (page 54), and MIDI Songs which have been copied/moved to the instrument using File operations (page 66).
<b>USB</b>	MIDI/Audio Songs saved to the USB flash drive by recording them with this instrument or Audio Songs converted from MIDI Songs (page 70), or MIDI/Audio Songs saved to the USB flash drive.

3. Press the [▶] button to display the Songs in the specified category, and then select a desired Song using the [▲]/[▼] buttons.

When “User” or “USB” category is selected, the icon indicating Song types are shown to the left of the Song name.

### NOTE

- Before using a USB flash drive, be sure to read “Connecting USB Devices ([↔] (USB TO DEVICE) terminal)” on page 75.
- The instrument can automatically select a Song file saved in the root directory of the USB flash drive as soon as the USB flash drive is connected. For instructions, refer to “USB Autoload” on page 106.

### NOTE

USB folder appears only when USB flash drive is connected to the [↔] (USB TO DEVICE) terminal.

### NOTE

Press the [◀] button to return to the category/folder.

### NOTE

“NoSong” will be shown in the display when no data exists in that folder.

**Song List**



icon	Data format
	Folder
	MIDI Songs
	Audio Songs

**To select a recorded Song saved to USB flash drive:**

When you record a Song and save it to a USB flash drive, the recorded Song will automatically be saved to the USER FILES folder on a USB flash drive. If you want to select the Song from the USER FILES folder, select USB in step 2, and USER FILES folder in step 3.

**4. Press the [▶] button to select the desired Song.**

The Song display is shown letting you to see the currently selected Song name and its category name.

**Song display: MIDI Song**

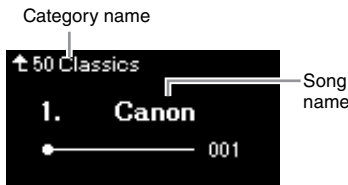

**Song display: Audio Song**



**5. Press the [PLAY/PAUSE] button to start playback.**

The current position of the Song playback will be shown.

**Song display: MIDI Song**

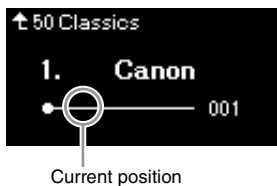

**Song display: Audio Song**

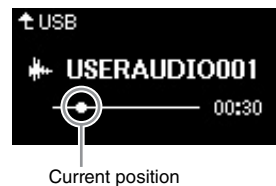

You can play the keyboard along with Song playback. You can also change the Voice for your keyboard performance. To adjust the volume balance between your keyboard performance and MIDI Song playback, or to adjust the Audio Volume, set the appropriate Volume parameters individually in the “Song” menu display (page 52).

**6. Press the [PLAY/PAUSE] button again to stop playback.**

Even if you don't press the [PLAY/PAUSE] button, the Song stops automatically when Song playback reaches the end.

**When Songs cannot be read from a USB flash drive**

If the song cannot be read, you may need to change the Language setting for the Song name in the “System” menu display (page 107).

**NOTE**

- Press the [▲] button to return to the Song list.
- When the Song title is too long to be displayed, hold down the [▼] button to see the full title on the pop-up window.

**NOTE**

Songs having titles longer than 48 characters cannot be played on this instrument.

**NOTE**

If a Song has been selected, the original tempo of the Song is used, and the Metronome setting (page 41) will be ignored.

**NOTE**

Useful playback functions are described on pages 48 – 53.

## Rewind/Fast forward/Returning to the top of the Song

### Rewind/Fast forward

Use the [◀] and [▶] buttons to move back or forth through the Song (in bars or seconds), while the Song display is shown.

Song display: MIDI Song

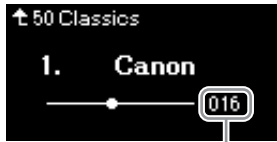

Measure number

Song display: Audio Song



Elapsed time

Holding one of the buttons scrolls backward/forward continuously.

### Returning to the top of the Song

Pressing the [◀] and [▶] buttons simultaneously returns to the top position of the Song.

## Adjusting the tempo

You can adjust the playback tempo of a Song.

### 1. Press the [TEMPO] button to call up the “Tempo” display.

For a MIDI Song, press the [TEMPO] button during Song playback or while the Song display is shown. For an Audio Song, press the [TEMPO] button during Song playback.

MIDI Song

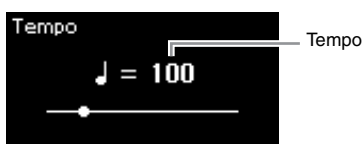

Audio Song

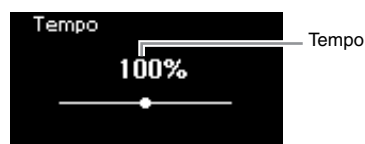

#### NOTE

Changing the tempo of an Audio Song may change its tonal characteristics.

### 2. Change the Tempo value using the [◀]/[▶] buttons.

The original tempo of the current Song can be recalled by pressing the [◀] and [▶] buttons simultaneously.

#### For MIDI Songs

The tempo range differs depending on the Time Signature for the selected MIDI Song. Available setting values may only include even numbers (multiples of 2), depending on the Time Signature. For more information, refer to page 42.

#### For Audio Songs

The tempo range is between 75% – 125%. 100% is the original tempo value. Higher values result in a faster tempo.

### 3. Press the [EXIT] button to exit from the “Tempo” display.

## Playing a One-hand Part — Part Cancel Function (MIDI Songs)

**MIDI** Audio

Some MIDI Songs, such as Preset Songs, are divided into right-hand and left-hand parts. By using such Song data, you can practice the left hand by turning on only the right-hand part, and practice the right hand by turning on only the left-hand part—allowing you to practice parts separately for easy mastery of difficult material.

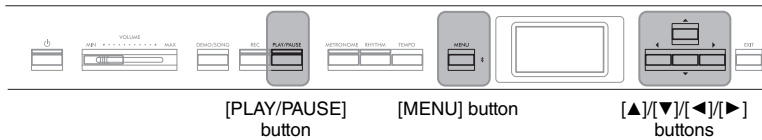

### 1. Select a Song for practicing.

For instructions, refer to page 45. The Song category “50 Classics” is recommended.

### 2. Select a part you want to practice.

Press the [MENU] button repeatedly to call up the “Song” menu display, then select the highlighted item in each display as illustrated below.

In the “L/R” display, select the part (track) you want to mute for practicing. Select “R” for practicing the right-hand part, or “L” for the left-hand part.

“Song” menu display

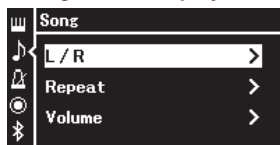

“L/R” display



2-1. Use the [▲]/[▼] buttons to select “L/R.”

2-2. Press the [▶] button to call up the next display.

2-3. Use the [▲]/[▼] buttons to select desired track.

### 3. Use the [▶] button to select “Off” for the selected part.

### 4. Press the [PLAY/PAUSE] button to start playback.

Play and practice the part you just muted.

### 5. Press the [PLAY/PAUSE] button again to stop playback.

Even if you don't press the [PLAY/PAUSE] button, the Song stops automatically when Song playback reaches the end.

#### NOTE

Some songs in “50 Classics” are duet songs. Refer to page 112 about part assignment for the duet songs.

#### NOTE

- The parts can be turned on or off even during playback.
- Usually, Channel 1 is assigned to “R,” Channel 2 is assigned to “L,” and Channels 3 – 16 are assigned to “Extra.” However, the assignments may differ depending on the particular Song. Channels assigned to “Extra” cannot be set to on or off individually.
- Whenever you select another MIDI Song, both parts are automatically turned on.



## Playing Back a Song Repeatedly

There are three Repeat items as follows. These are convenient for repeatedly practicing difficult phrases. It is a good idea to use this function and the Part Cancel function (above) for practicing difficult phrases, in the case of MIDI Songs.

- **AB Repeat** ..... Plays the specified range of the selected MIDI Song repeatedly.
- **Phrase Repeat**..... Plays a specific phrase of a MIDI Song containing Phrase Marks repeatedly.
- **Song Repeat**..... Plays a MIDI/Audio Song repeatedly, or plays all MIDI/Audio Songs saved in a selected category (folder) repeatedly either in order or in random order.

The explanations here apply only to AB Repeat and Song Repeat. For Phrase Repeat, refer to page 98.

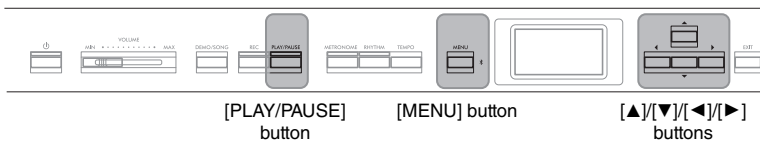

### Phrase mark

A pre-programmed marker in certain MIDI Song data, which specifies a specific location in the Song.

### 1. Select a Song to be played back.

For instructions, refer to page 45.

### 2. Call up the “Repeat” display.

Press the [MENU] button repeatedly to call up the “Song” menu display. Select “Repeat,” then press the [▶] button.

“Song” menu display

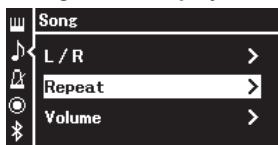

“Repeat” display

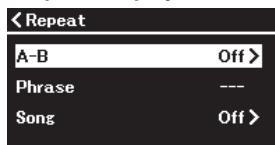

### 3. In the “Repeat” display, select a desired item using the [▲]/[▼] buttons, then press the [▶] button.

Select “A–B” for AB Repeat, select “Phrase” for Phrase Repeat, or select “Song” for Song Repeat.

### 4. Set in the appropriate setting display.

- **AB Repeat** .....See page 50.
- **Phrase Repeat**.....See page 98 (“Phrase” section in “Repeat”).
- **Song Repeat** .....See page 51.

## AB Repeat setting

MIDI

Audio

See page 49 for information on basic operations. Continuing from step 4 on that page, follow the procedure below.

4-1. Press the [PLAY/PAUSE] button to start Song playback.

4-2. Press the [▶] button at the starting point (A) of the range to be repeated.

“A-B” display



### Specifying the top of a Song as Point A

Specify Point A before starting playback, then start playback and specify Point B.

4-3. Press the [▶] button again at the ending point (B).

After an automatic lead-in (to help guide you into the phrase), the range from Point A to Point B is played back repeatedly.

### Specifying the end of a Song as Point B

Specifying only Point A results in repeat playback between Point A and the Song end (as Point B).

5. To turn off the Repeat function, press the [▶] button while “Repeat Off” is highlighted, or select another Song.



### NOTE

You can also specify the repeat range by the following procedure.

- 1 Highlight the measure number using the [▲] button, then fast-forward the Song to Point A using the [◀]/[▶] buttons.
- 2 Highlight “Set A” using the [▼] button, then press the [▶] button.  
After specifying Point A, the display for specifying Point B is called up.
- 3 Specify Point B in the same way as Point A.

## Song Repeat setting

MIDI | Audio

See page 49 for information on basic operations. Continuing from step 4 on that page, follow the procedure below.

- 4-1. Select the desired Repeat type using the [◀]/[▶] buttons in the setting display.

Setting display







Default setting: Off

<b>Off</b>	Disables Repeat playback. The Song stops automatically when playback of the selected Song reaches the end.
<b>Single</b>	Plays through the selected Song repeatedly.
<b>All</b>	Continuously plays back all Songs in the selected category in order.
<b>Random</b>	Continuously plays back all Songs in the selected category in random order.

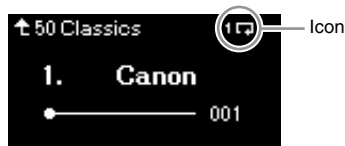
- 4-2. Press the [PLAY/PAUSE] button to start Repeat playback.

Icons corresponding to each Repeat setting are shown on the Song display.



While the Repeat setting is on,  (Single),  (All), or  (Random) is shown in the upper right corner of the Song display.

5. To turn off the Repeat function, press the [PLAY/PAUSE] button again to stop playback, and then select “Off” in step 4-1.

## Adjusting the Volume Balance

**MIDI** | **Audio**

When a MIDI Song is selected, you can adjust the Volume balance between the Song playback and the sound you are playing on the keyboard, or between the Right and Left parts of the selected Song. When an Audio Song is selected, you can adjust the Audio Song volume.

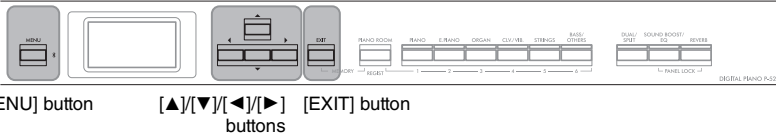

1. Select the desired Song beforehand. (page 45)
2. Press the [MENU] button repeatedly to call up the “Song” menu display. Select “Volume”, and then press the [▶] button.



(When a MIDI Song is selected)  
“Song” menu display

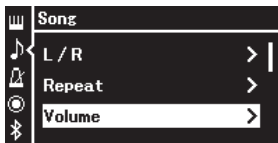

(When an Audio Song is selected)  
“Song” menu display

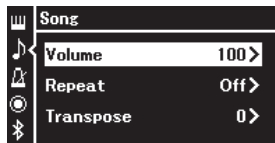

3. When a MIDI Song is selected, select “Song – Keyboard” or “Song L – R” using the [▲]/[▼] buttons, then press the [▶] button to call up the setting display.

<b>Song – Keyboard</b>	Adjust the Volume balance between the MIDI Song playback and your keyboard performance.
<b>Song L – R</b>	Adjust the Volume balance between the Right and Left parts of the selected MIDI Song.

**When an Audio Song is selected, use the [◀]/[▶] buttons to set the Audio playback volume. After setting the value, go on to step 5.**

(When a MIDI Song is selected)

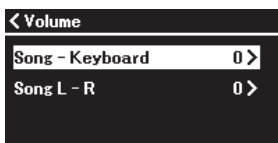

(When an Audio Song is selected)

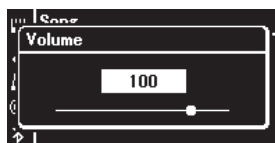

**NOTE**

Some commercially available music data (MIDI Song) play back at extremely high levels. When using such data, adjust the “Song - Keyboard” setting.

#### 4. Adjust the Volume balance by using the [◀]/[▶] buttons.

In the case of  
“Song – Keyboard”:



←      →  
The volume of your keyboard performance will be lower.      The Song playback volume will be lower.

In the case of  
“Song L – R”:



←      →  
R part volume will be lower.      L part volume will be lower.

#### 5. Press the [EXIT] button twice to exit from “Song” menu display.

Whenever you select another MIDI Song, the setting for “Song L – R” is restored to its default setting. As for “Song – Keyboard” and Audio Volume, selecting another Song will not reset the value.

##### Song - Keyboard

**Default setting:** 0

**Setting range:** Key+64 – 0 – Song+64

##### Song L - R

**Default setting:** 0

**Setting range:** L+64 – 0 – R+64

##### NOTE

The selected parameters of “Song – Keyboard” will be maintained (Backup Setting) even when the power is turned off. Make sure not to set the volume levels to minimum. Otherwise the sound of keyboard or songs will not be played. You can change the settings to maintain the selected parameter or not. For details, refer to “Backup Setting” on page 90.

## Useful Playback Functions

MIDI

Audio

### Starting/pausing playback by using a pedal

You can assign the Song Play/Pause function (the same function as the [PLAY/PAUSE] button on the front panel) to the included foot pedal or the footswitch (sold separately) connected to the [AUX PEDAL] jack, or the center or left pedal of the pedal unit (sold separately) connected to the [PEDAL UNIT] jack. Press the [MENU] button repeatedly to call up the “System” menu display, and then select “Pedal” → “Play/Pause” to make the assignment.

This is convenient for starting or pausing playback when you are performing and can't take your hands from the keyboard.

### Transposing the pitch of a Song

You can shift the pitch of Song playback up or down in semitone intervals. You can change the settings via the “Song” menu display: Press the [MENU] button repeatedly to call up the “Song” menu display → “Transpose” (page 98).

##### NOTE

The audio sound input from an external device (page 54) cannot be transposed.

# Recording Your Performance

This instrument allows you to record your performance in the following two methods.

## • MIDI Recording **MIDI**

With this method, your performances are recorded as an SMF (format 0) MIDI file and saved to the instrument or a USB flash drive. If you want to re-record a specific section or edit parameters such as Voice, use this method. Also you can record your performance to each Track one by one. Since a MIDI Song can be converted to an Audio Song after recording (page 70), you may want to use MIDI recording (with overdubbing and multiple parts) to first create a complex arrangement you would not otherwise be able to play live, then convert it to an Audio Song. This instrument allows you to record approximately 500 KB of data per Song.

## • Audio Recording **Audio**

With this method, recorded performances are saved to a USB flash drive as an Audio file. Recording is done without designating the recorded part. Since it is saved in stereo WAV format of normal CD quality resolution (44.1 kHz/16 bit), it can be transmitted to and played on portable music players by using a computer. Because the audio sound input\* from the external device is also recorded, you can record your keyboard performance along with the performance sound of the connected audio device, computer, or smart device, etc. This instrument allows you to record up to 80 minutes per single recording.

\* Audio sound input (Audio input sound):  
Audio data sent to this instrument from the external devices such as a computer or a smart device, etc., when connecting the instrument with the devices via [AUX IN] jack, [USB TO HOST] terminal, wireless LAN, or Bluetooth. For connection with these devices, refer to the "Connecting to Other Devices" section from page 74.

For details about the difference between MIDI Songs and Audio Songs, refer to page 44.

## Recording Methods

This chapter covers the following four methods. Note that the created data format differs depending on the method, MIDI or Audio.

### • Quick MIDI Recording **MIDI** ..... page 55

This method lets you start recording most quickly. Your performance will be recorded and saved to the "User" category (page 45) in this instrument's internal memory.

### • MIDI Recording — Independent Tracks **MIDI** ..... page 57

This lets you record the right, left and extra parts separately. Since you can record the left part while playing back the right, this is useful for recording both parts of a duet. Since you can record up to sixteen parts separately, record the performance of each instrument part one by one and create fully orchestrated compositions.

### • MIDI Recording to the USB Flash Drive **MIDI** ..... page 59

This method is useful when you want to overwrite the already recorded MIDI Song in the USB flash drive or create a New MIDI Song on the USB flash drive.

### • Audio Recording to the USB Flash Drive **Audio** ..... page 61

This method lets you record your performance as Audio data to the USB flash drive connected to the [↔] (USB TO DEVICE) terminal.

#### NOTE

You can re-record a specific range of the MIDI Song or change the tempo or the Voice of the recorded Song. For details, refer to "Other Recording Techniques" (page 62).

## Quick MIDI Recording

### MIDI

This method is the quickest way to start recording.

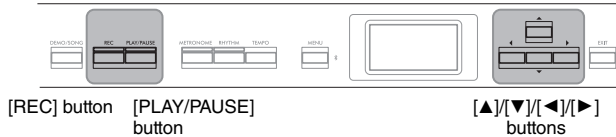

### 1. Make the necessary settings such as Voice selection and time signature.

For details on how to select a Voice, refer to page 20.

Before starting the Recording operation, turn Dual/Split/Duo on or off as desired and select a Reverb/Chorus/Effect type as desired.

Since you can also use the Metronome/Rhythm while recording, set the tempo and time signature of the Metronome/Rhythm (page 41) before starting recording.

### 2. Press the [REC] button to enable Recording ready.

The blank new Song for recording is automatically set.

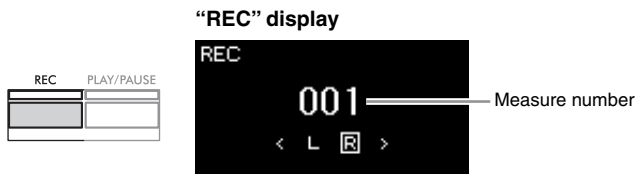

The [PLAY/PAUSE] button will flash at the current tempo.

To exit from the Recording mode, press the [REC] button again.

### 3. Play the keyboard to start recording.

When you wish to record an empty section at the start of the Song, press the [PLAY/PAUSE] button to start recording.

"REC" display (during recording)

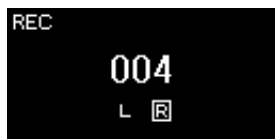

### 4. After you finish your performance, press the [REC] button again to stop recording.

This operation exits from the Recording mode and calls up the display for saving the recorded performance data.

#### NOTE

If you want to record the left-hand and right-hand parts individually, refer to "MIDI Recording—Independent Tracks" (page 57), since the Recording method here assumes that both the left and right parts are being recorded together.

#### NOTE

- You can use the Metronome/Rhythm while recording. While the Metronome sound cannot be recorded, the Rhythm sound can. Make sure to start enter the Recording mode before starting Rhythm playback, since entering the Recording mode during playback of the Rhythm stops its playback.
- The "Song – Keyboard" Volume Balance (page 52) will not be recorded.
- With MIDI recording, the performance will be recorded to Track 1. However, in the Dual/Split/Duo mode, the tracks assigned for recording and the tracks actually used for recording are different. For details refer to "Recording Track Assignment" on page 57.

#### NOTE

Pressing and holding the [REC] button for a second will call up the display which lists the Recording Target Songs. In this case, select "New Song" then press the [▶] button. For details, refer to the table on page 60.

#### NOTE

- When a Rhythm (page 43) is selected, press the [RHYTHM] button to start Rhythm playback and MIDI recording simultaneously.
- If desired, you can change the Voice, turn the Dual/Split on, or recall the settings registered to the Registration Memory.



## 5. Select “Save” or “Retry” or “Cancel” for the recorded performance in the “Confirm” display.

- If you want to save the recorded performance, select “Save,” then press the [▶] button.
- If you are not satisfied with your performance and want to record again, highlight “Retry” then press the [▶] button. Try recording again from step 3.
- If you do not want to save the recorded data, highlight “Cancel” then press the [▶] button.



After the Save operation is completed, the display shows “Save Completed” then returns to the Song display. The recorded Song will be named “USERSONGxxx” (xxx: number) and saved in the “User” category.

## 6. To hear the recorded performance, press the [PLAY/PAUSE] button.

### NOTICE

The recorded MIDI Song will be lost if you change to another Song or you turn the power off without executing the Save operation.

### Renaming the recorded Song

The recorded Songs are named automatically, but you can rename Songs as you like (page 71).

### NOTE

Refer to page 68 for how to delete a Song.

Data that can be recorded to MIDI Songs	
<p><b>Data for each Track</b></p> <ul style="list-style-type: none"> <li>• Note data (your keyboard performance)</li> <li>• Voice selection</li> <li>• Pedal operations (Damper/Soft/Sostenuto)</li> <li>• Reverb Depth</li> <li>• Chorus Depth</li> <li>• Effect Type</li> <li>• Effect Depth</li> <li>• Sound brightness — “Brightness”</li> <li>• Resonance effect setting — “Harmonic Cont”</li> <li>• Octave</li> <li>• Volume setting for each Voice — “Volume”</li> <li>• Pan for each Voice</li> <li>• Detune</li> <li>• Touch Sensitivity — “Touch Sens.”</li> <li>• Grand Expression Modeling data</li> </ul>	<p><b>Data commonly for all Tracks</b></p> <ul style="list-style-type: none"> <li>• Scale</li> <li>• Tempo</li> <li>• Time Signature</li> <li>• Reverb Type</li> <li>• Chorus Type</li> </ul>

### NOTE

Parameter settings other than Voice and Tempo, such as note data, pedal (Damper/Soft/Sostenuto) data, octave setting and time signature, cannot be changed after recording.



## MIDI Recording — Independent Tracks

### MIDI

With MIDI Recording, you can create a MIDI Song consisting of 16 tracks by recording your performance to each track one by one. In recording a piano piece, for example, you can record the right-hand part to Track 1 then record the left-hand part to Track 2, allowing you create a complete piece which may be difficult to play live with both hands together. To record a performance with Rhythm playback, for example, record Rhythm playback, then record melodies to Track 1 while listening to the already recorded Rhythm playback. In this way, you can create an entire Song which would otherwise be difficult, or even impossible, to play live.

#### Example:

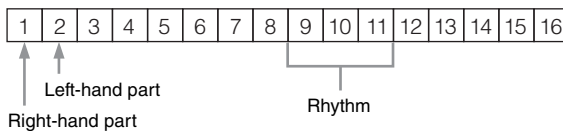

#### When you want to record a new track of an already recorded MIDI Song:

1. Execute the same operation in step 1 in “Quick MIDI Recording” (page 55).
2. Select the target MIDI Song (steps 1–4 on page 45).
3. Press and hold the [REC] button for a second to call up the display which lists recording target Songs (page 59).
4. Select the 4th item (the selected MIDI Song), press the [▶] button, and then go to step 2 on this page.

1. Execute the same operations as in step 1 and step 2 on page 55 to enter the Recording mode with a new blank Song selected.

2. Use the [◀]/[▶] buttons to select a Recording Track.

Rhythm cannot be added to a recorded Song. When you want to record Rhythm, make sure to record the Rhythm playback first.

When you want to record the right-hand part, highlight “R” (Track 1). When you want to record the left-hand part, highlight “L” (Track 2). Alternately, when you want to record your performance to Tracks 3 – 16, call up the desired one by pressing the [◀]/[▶] buttons repeatedly. If the Rhythm playback was recorded first before other tracks, it is automatically recorded to one of the Tracks 9 – 11 (or all the three tracks). If this is the case, select the desired track for recording from any except for these tracks.

#### NOTE

If you want to record your performance to the USB flash drive or you want to add the recording to the MIDI Song in the USB flash drive, refer to “MIDI Recording to the USB flash drive” (page 59).

#### Recording Track Assignment

- When recording the Rhythm, you cannot freely select desired tracks. The Rhythm is recorded to Tracks 9 – 11.
- When Dual/Split/Duo is on, only the R1 Voice performance will be recorded to the selected Track, and the R2 Voice performance will be recorded to the Track number which is 6 plus the selected Track, and the L Voice performance of Split/Duo will be recorded to the Track number which is 3 plus the selected Track. Rhythm playback will be recorded to Tracks 9 – 11.





### 3. Start recording.

Play the keyboard to start recording.

When you want to record the Rhythm playback first, press the [RHYTHM] button to start recording.

When you want to record an empty section at the start of the Song, press the [PLAY/PAUSE] button to start recording.

### 4. After you finish your performance, press the [REC] button to stop recording.

This operation exits from the Recording mode and calls up the display for saving the recorded performance data.

### 5. If you want to save the recorded performance, press the [▶] button to execute the Save operation while “Save” is highlighted.

- If you save the recorded performance, select “Save,” then press the [▶] button.
- If you are not satisfied with your performance and want to record again, highlight the cursor to “Retry” then press the [▶] button. Try recording again from step 3.
- If you do not want to save the recorded data, highlight “Cancel” then press the [▶] button.

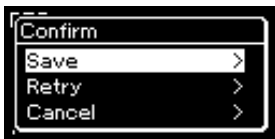

After the Save operation is completed, the display shows “Save Completed” then returns to the Song display. The recorded Song will be named “USERSONGxxx” (xxx: number) and saved in the “User” category.

### 6. To hear the recorded performance, press the [PLAY/PAUSE] button.

#### NOTICE

Note that recording your performance to a Track containing data will overwrite the previously recorded data.

#### NOTE

Because bass accompaniment of the Rhythm sounds only when playing the keyboard, in order to record the bass accompaniment, it is necessary to record keyboard performance with it as well.

#### NOTICE

The recorded MIDI Song will be lost if you change to another Song or you turn the power off without executing the save operation.

#### NOTE

After saving your recorded performance, if you want to record it again, refer to “Re-recording a MIDI Song in parts” (page 62).

#### Renaming the recorded Song

The recorded Songs are named automatically, but you can rename Songs as desired (page 71).

#### NOTE

For instructions on rewinding, fast-forwarding and returning to the top of the Song during Song playback, refer to page 47.

## 7. To record another Track, enter the Song Recording mode again.

### 7-1. Press and hold the [REC] (Record) button for a second.

The Recording Target Songs will be listed on the display.

### 7-2. Use the [▼] button to select existing MIDI Song (at the bottom of the list), then press the [▶] button.



You can check whether or not each Track contains recorded data by the indication that appears at the upper right of each Track. For details on the indication, refer to “Track Data Status” on page 58.

## 8. Record your performance to another track by repeating steps 2 – 6 of this section.

In step 2, select a track which has no recorded data. In step 3, play the keyboard while listening to the already recorded data.

### NOTICE

Note that recording your performance to a Track containing data will overwrite the previously recorded data.

### NOTE

Refer to page 68 for how to delete a Song. Refer to “Track Delete” on page 99 for how to delete a track.

## MIDI Recording to the USB Flash Drive

### MIDI

These instructions describe how to overwrite an already recorded MIDI Song in the USB flash drive or how to create a New MIDI Song on the USB flash drive.

## 1. Connect the USB flash drive to the [•↔•] (USB TO DEVICE) terminal.

## 2. Select a MIDI Song as Recording target, then enter the Recording mode.

### 2-1. If you want to record an additional Track to the already recorded MIDI Song, select the desired MIDI Song in the USB flash drive.

If you want to record from scratch, skip this step.

### 2-2. Press and hold the [REC] button for a second to call up the display which lists the Recording Target Songs.



### NOTE

- To connect a USB flash drive, be sure to read the section “Connecting USB Devices” on page 75.
- Before starting the Recording operation, check the remaining memory capacity of the USB flash drive. “System” menu: “Utility” → “USB Properties” (page 106).

- 2-3. From the Recording Target Songs, select “New Song (USB)” or the MIDI Song selected in step 2-1 (4th item below) using the [▲]/[▼] buttons, then press the [▶] button to enter the Recording mode.

Recording Target Song	Description
New Song	Select this when you want to record your performance to a blank MIDI Song and save to “User” category in this instrument’s internal memory.
New Song (USB)*	Select this when you want to record your performance to a blank MIDI Song and save to the USB flash drive.
New Audio (USB)*	Select this when you want to record your performance to blank audio data and save to the USB flash drive.
XXXXXX (MIDI Song selected in step 2-1 above)**	Select this when you want to record additionally to/overwrite the currently selected MIDI Song.

\* Can be selected only when the USB flash drive is connected to the [↔] (USB TO DEVICE) terminal.

\*\* Will not be shown when an already recorded MIDI Song is not selected in step 2-1 above, or when a Preset Song is selected in step 2-1.

### 3. Execute the Recording operation, then save the recorded performance.

- **When you want to record additionally to the currently selected MIDI Song, or record to a specified track on a blank MIDI Song:**

Execute steps 2 – 8 in “MIDI Recording—Independent Tracks” on page 57.

- **When you want to quick record to a blank MIDI Song:**

Execute steps 3 – 6 in “Quick MIDI Recording” on page 55.

#### **NOTICE**

Note that recording your performance to a Track containing data will overwrite the previously recorded data.

#### **NOTE**

The time signature and tempo cannot be changed when replacing the part of an existing MIDI Song.

## Audio Recording to the USB Flash Drive

### Audio

These instructions describe how to record your performance as audio data. Note that an audio file to which your performance is to be recorded can be saved only to a USB flash drive. This is why you should prepare your USB flash drive device before starting the Recording operation.

1. **Connect the USB flash drive to the [  ] (USB TO DEVICE) terminal.**
2. **Press and hold the [REC] (Record) button for a second to call up the display which lists the Recording Target Songs.**
3. **Use the [▲]/[▼] buttons to select “New Audio (USB)” then press the [▶] button.**
4. **Execute steps 3 – 6 in “Quick MIDI Recording” (page 55).**  
Unlike with MIDI Recording, the elapsed time is shown on the display while Audio Recording is being executed.



Along with Audio recording, other audio input sounds (via Bluetooth, [AUX IN] etc.) from the external device (page 54) are also recorded.

### NOTE

To connect a USB flash drive, be sure to read the section “Connecting USB Devices” on page 75.

### NOTE

Before starting the Recording operation, check the remaining memory capacity of the USB flash drive. “System” menu: “Utility” → “USB Properties” (page 106).

### NOTE

With Audio recording, distorted sound may be produced if the Voice Volume is set to the value higher than the default setting. Make sure to set the Voice Volume to the default value or less before recording from the “Voice” menu display: “Voice Edit” → “Volume” (page 95).

## Other Recording Techniques

### Re-recording a MIDI Song in parts

#### MIDI

You can re-record a specific range of the MIDI Song. This is useful when editing MIDI Songs you have recorded yourself.

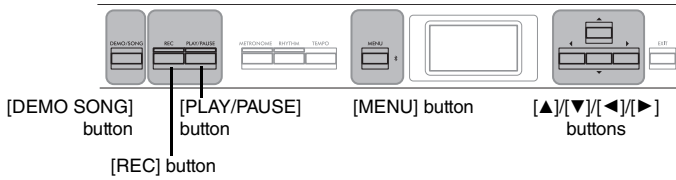

### 1. Set the parameters which determine how recording starts and stops.

1-1. Press the [MENU] button repeatedly to call up the “Recording” menu display.



1-2. Use the [▲]/[▼] buttons to select “RecStart,” then select the value which determines how recording starts by using the [▶] button.

<b>Normal</b>	The already recorded data will be replaced with the new one as soon as recording starts.
<b>KeyOn</b>	The already recorded data will be maintained until you press a key, and actual recording starts as soon as you press a key.

**Default setting:** Normal

1-3. Use the [▲]/[▼] buttons to select “RecEnd,” then select the value which determines how recording stops by using the [▶] button.

<b>Replace</b>	The data after the point you stop recording will also be erased.
<b>PunchOut</b>	The data after the point you stop recording will remain.

**Default setting:** Replace

## Examples of re-recording with various settings for starting/ stopping recording

This instrument features several different ways you can re-record a MIDI Song.

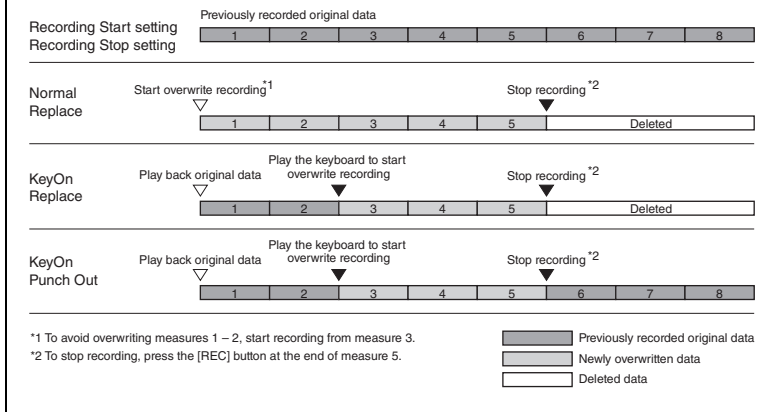

2. Press the [DEMO/SONG] button to call up the Song category list display.
3. Select the desired MIDI Song.  
For instructions, refer to page 45.
4. Specify the start point you wish to re-record.  
Use the [◀]/[▶] buttons to move the playback position (measure number) to the desired point. Alternately, press the [PLAY/PAUSE] button to start playback, then press the [PLAY/PAUSE] button again slightly prior to the desired point.  
  
If necessary, select the settings (Voice and other parameters).  
The time signature cannot be changed when replacing the part of an existing Song.
5. Press and hold the [REC] button for a second to call up the display which lists the Recording Target Songs, then select the 4th item (Song selected in step 3), then press the [▶] button to enter the recording mode.
6. Use the [◀]/[▶] buttons to select a Track for re-recording.
7. Play the keyboard or press the [PLAY/PAUSE] button to start recording.
8. Press the [REC] button to stop recording.
9. Save the recorded performance by following step 5 on page 56.
10. To hear the recorded performance, press the [PLAY/PAUSE] button.

## Changing the tempo or the Voice of a previously recorded MIDI Song

### MIDI

For MIDI Songs, you can change the tempo and Voice after recording to change a feel or to set a more suitable tempo.

### To change the tempo:

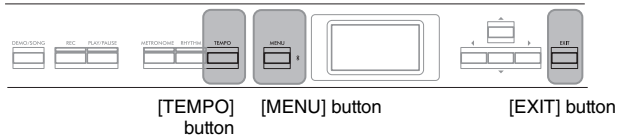

1. **Select the MIDI Song you wish to change.**  
For instructions, refer to page 45.
2. **Press the [TEMPO] button to call up the “Tempo” display, then set the desired Tempo.**  
For instructions, refer to page 41.
3. **Press the [MENU] button repeatedly to call up the “Song” menu display, then select the highlighted item in each display as illustrated below.**

“Song” menu display



- 3-1. Use the [▲]/[▼] buttons to select “Edit.”
- 3-2. Press the [▶] button to call up the next display.

“Edit” display

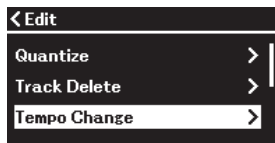

- 3-3. Use the [▲]/[▼] buttons to select “Tempo Change.”
- 3-4. Press the [▶] button to call up the next display.

4. **Apply the selected Tempo value to the current MIDI Song data.**

Press the [▼] button to highlight “Execute,” then press the [▶] button to apply the new Tempo value to the current MIDI Song data.

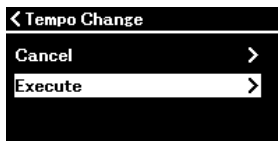

When this operation is completed, “Completed” is shown on the display, and the “Tempo Change” display will be restored after a while.

5. **Press the [EXIT] button to exit from the “Song” menu display.**



## To change the Voice:

1. **Select the MIDI Song you wish to change.**  
For instructions, refer to page 45.
2. **Select the desired Voice.**  
For instructions, refer to page 20.
3. **Press the [MENU] button repeatedly to call up the “Song” menu display, then select the highlighted item in each display as illustrated below.**

“Song” menu display

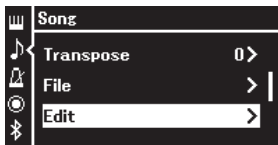

“Edit” display

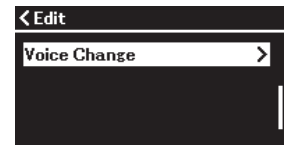

3-1. Use the [▲]/[▼] buttons to select “Edit.”

3-2. Press the [▶] button to call up the next display.

3-3. Use the [▲]/[▼] buttons to select “Voice Change.”

3-4. Press the [▶] button to call up the next display.

4. **Press the [▶] button to call up the setting display, then select the desired Track using the [▲]/[▼] buttons.**

“Voice Change” display

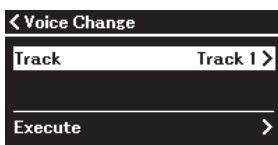

5. **After pressing the [◀] button to return to the “Voice Change” display, press the [▼] button to highlight “Execute,” and then press the [▶] button.**

The Voice selected in step 2 is applied to the Track selected in step 4.

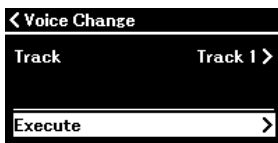

When this operation is completed, “Completed” is shown on the display, and the “Voice Change” display will be restored after a while.

6. **Press the [EXIT] button to exit from the “Song” menu display.**

# Handling Song Files

The “File” menu in the “Song” menu display (page 98) enables you to apply various operations to Song files — Songs you recorded on this instrument or commercially available Songs.

To connect a USB flash drive, be sure to read the section “Precautions when using the [  ] (USB TO DEVICE) terminal” on page 75.

Operation	File menu	Page
Deleting files	Delete	pages 67, 68
Copying files	*Copy	pages 67, 68
Moving files	*Move	pages 67, 69
Converting a MIDI Song to an Audio Song during playback	*MIDI to Audio	pages 67, 70
Renaming files	Rename	pages 67, 71

## File

A file contains a group of data. On this instrument, a Song file includes Song data and a Song name.

Settings marked with a “\*” are effective only when a MIDI Song is selected.



## Song Types and File Operation Limitations

Song types are indicated as the category name and icon in the Song display. The following chart shows the Song type and restrictions on File operations.

\* The icon appears only when you select a Song in the “User” or “USB” category.



O: Yes, x: No

Data Location	Category	Song Type	Icon	Delete	Copy	Move	MIDI to Audio	Rename
	Instrument	Demo	Demo (Voice Demo)	—	x	x	x	x
50 Classics		50 classical Preset Songs	—	x	x	x	x	x
User		Your own recorded Songs (MIDI)		O	O	O	O	O
USB flash drive device	USB	MIDI Songs		O	O	O	O	O
		Audio Songs		O	x	x	x	O

## Range of the Copy/Move operation

As for a MIDI Song in the “User” category in the instrument, you can Copy/Move it only to the USER FILES folder on a USB flash drive. Selecting a MIDI Song from “User” for copying/moving automatically specifies the USER FILES folder as the destination.

As for a MIDI Song in a USB flash drive, you can Copy/Move it to the “User” category in the instrument.

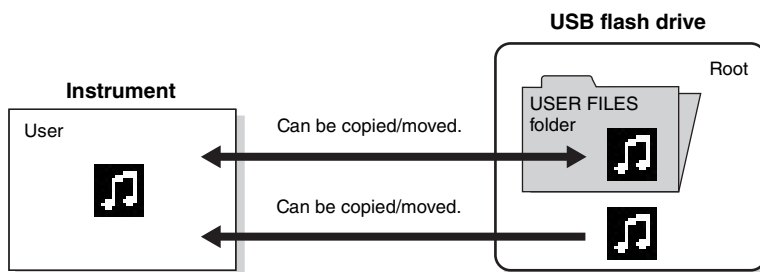

## USER FILES folder

If the USB flash drive device plugged into the instrument contains no USER FILES folder, one will be created automatically when you format or record a Song to that device. The recorded Song will then be saved in that folder.

## NOTE

- Please note that the copy features are intended for your personal use only.
- Folders cannot be copied.

## Root:

The highest level of a hierarchical structure. This indicates an area which does not belong to a folder.

## Basic Song File Operation

Song files can be handled via the instructions shown below.

1. **Connect the appropriate USB flash drive containing the desired files to the [↔] (USB TO DEVICE) terminal as necessary.**
2. **Select a Song for handling.**  
For information on selecting a Song, see page 45.
3. **Select the desired operation.**

- 3-1. Press the [MENU] button repeatedly to call up the “Song” menu display. Use the [▲]/[▼] buttons to select “File,” and then press the [▶] button.



- 3-2. Use the [▲]/[▼] buttons to select the desired operation from “Delete,” “Copy,” “Move,” “MIDI to Audio” or “Rename.”

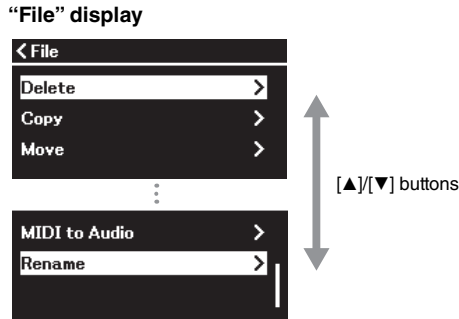

From here, if you wish to exit from the “File” display, press the [EXIT] button once or twice.

4. **Execute the selected operation.**

For specific instructions, refer to the corresponding section.

- **Delete** .....page 68
- **Copy** .....page 68
- **Move** .....page 69
- **MIDI to Audio** .....page 70
- **Rename** .....page 71

During operation, messages (information, confirmation, etc.) may be shown on the display. For explanations and details, refer to “Message List” on page 113.

5. **Press the [EXIT] button to exit from the “File” display.**

**NOTICE**

Do not disconnect the USB flash drive during file handling or when a USB flash drive is mounted. Doing so may delete all data in the USB flash drive and the instrument.

## Deleting Files — Delete

For details about Song types which can be deleted, refer to page 66.

See page 67 for information on basic operations.

The following is a detailed procedure of step 4 on that page.

### 4-1. While “Delete” is highlighted, press the [▶] button.

The setting display is called up.

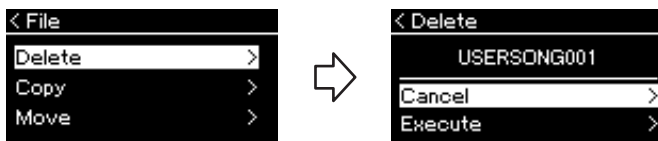

### 4-2. Highlight “Execute” by pressing [▼] button, and then press the [▶] button.

After the Song is deleted, the display returns to the Song List display.

**NOTICE**

Do not turn off the power or eject the USB flash drive while “Executing” is shown in the display.

## Copying Files — Copy

For details about Song types and ranges that can be copied, refer to page 66.

See page 67 for information on basic operations.

The following is a detailed procedure of step 4 on that page.

### 4-1. While “Copy” is highlighted, press the [▶] button.

The setting display is called up.

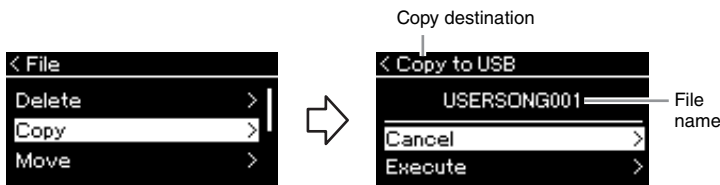

“USB” will be shown when the copy destination is the USB flash drive or “User” when the instrument is the copy destination. A file copied to the USB flash drive is stored to the USER FILES folder on it.

**NOTE**

A message appears when a Song with the same name already exists in the copy destination. Select “Overwrite” when you want to overwrite the selected Song, or “Cancel” to cancel by using the [▲]/[▼] buttons, and then press the [▶] button.

### 4-2. Highlight “Execute” by pressing [▼] button, then press the [▶] button.

The selected Song will be copied to the destination with the same name as the copy source file.

**NOTICE**

- **Overwrite operations erase any existing data of the copy destination file and overwrite with data of the copy source file.**
- **Do not turn off the power or eject the USB flash drive while “Executing” is shown in the display.**

## Moving Files — Move

For details about Song types and range that can be moved, refer to page 66.

See page 67 for information on basic operations.

The following is a detailed procedure of step 4 on that page.

### 4-1. While “Move” is highlighted, press the [▶] button.

The setting display is called up.

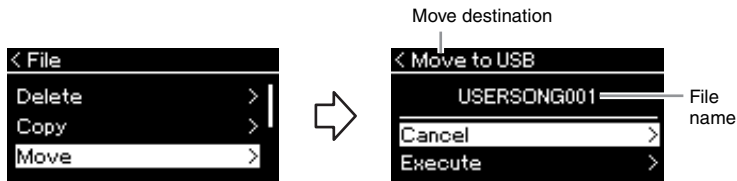

“USB” will be shown when the move destination is the USB flash drive or “User” when the instrument is the move destination. A file moved to the USB flash drive is stored to the USER FILES folder on it.

### 4-2. Highlight “Execute” by pressing the [▼] button, then press the [▶] button.

The selected Song will be moved to the destination and the display returns to the Song list display.

#### NOTE

A message appears when a Song with same name already exists in the move destination. Select “Overwrite” when you want to overwrite the selected Song, or “Cancel” to cancel by using the [▲]/[▼] buttons, then press the [▶] button.

#### NOTICE

- **Overwrite operations erase any existing data of the move destination file and overwrite with data of the move source file.**
- **Do not turn off the power or eject the USB flash drive while “Executing” is shown in the display.**

## Converting a MIDI Song to an Audio Song during Playback — MIDI to Audio

A MIDI Song in the User memory of the instrument or on a USB flash drive can be converted to an Audio Song. Since an Audio Song can be saved only to a USB flash drive, you should start conversion only after connecting the USB flash drive to the instrument. For information about which Song types can be converted, refer to page 66.

See page 67 for information on basic operations. The following is a detailed procedure of step 4 on that page.

### 4-1. While “MIDI to Audio” is highlighted, press the [▶] button.

The setting display is called up.

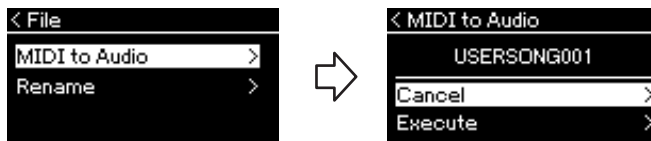

### 4-2. Highlight “Execute” by pressing the [▼] button, then press the [▶] button.

This operation starts playback and conversion from MIDI to Audio. This is basically the same as that of Audio Song Recording, which allows you to record your keyboard performance and other audio input sounds (via Bluetooth, [AUX IN] etc.) from the external device (page 54). After you convert the Song, a message “Convert completed” will be shown and the display returns to Song List display.

The Audio Song converted from a MIDI Song is saved with the same name as the MIDI Song. The icon displayed to the left of the Song name on the instrument display is changed, and the Song file extension on the computer is changed to “.wav”.

#### NOTE

- After conversion, the MIDI Song remains in the original data location.
- If you start conversion before connecting the USB flash drive to the instrument, an error message appears on the display.

#### NOTICE

**Do not turn off the power or disconnect the USB flash drive during the conversion. Otherwise the data will be lost.**

#### NOTE

- A message appears when a Song with same name already exists in the copy destination. Select “Overwrite” when you want to overwrite the selected Song by using the [▲]/[▼] buttons, then press the [▶] button.
- To cancel this operation, press the [EXIT] button during the conversion. When the operation is canceled, the converted Audio Song will not be saved.

## Renaming Files — Rename

For details about Song types which can be renamed, refer to page 66.

See page 67 for information on basic operations.

The following is a detailed procedure of step 4 on that page.

### 4-1. While “Rename” is highlighted, press the [▶] button.

The setting display is called up.

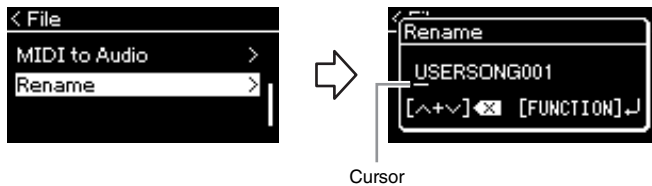

### 4-2. Assign a name to the Song.

Use the [◀]/[▶] buttons to move the highlight (underline).

Use the [▲]/[▼] buttons to change the character at the current cursor position. Pressing both buttons simultaneously will delete the character at the current cursor position.

A Song name can contain up to 48 characters. Characters which extend beyond the display capacity and are not visible can be viewed by moving the highlight by using the [◀]/[▶] buttons.

### 4-3. Press the [MENU] button to actually rename the file.

After the Song is renamed, the display returns to Song List display where the renamed Song can be selected.

#### NOTE

For information about the character types available for the Song name, refer to “Language” on page 107.

#### NOTICE

Do not turn off the power or eject the USB flash drive while “Executing” is shown in the display.

# Saving and Recalling Desired Settings (Registration Memory)

The Registration Memory function allows you to save (or “register”) settings such as Voice and Style to buttons on the front panel, and then instantly recall your desired settings. This instrument has four memory spaces; Bank A–D and the six settings can be saved to each bank. If a bank has already been selected, you can recall the saved settings only by holding down the [REGIST] button and pressing one of [1]–[6] buttons.

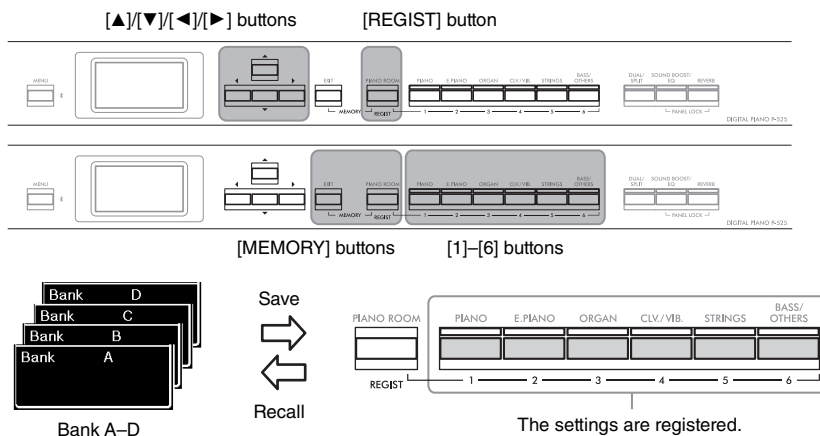

## Saving the Settings to the Registration Memory

1. Set up the panel controls (such as Voices, Rhythms and so on) as desired.
2. While holding down the [REGIST] button, use the [▲]/[▼] buttons to select the bank.

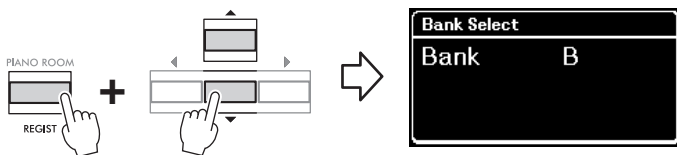

3. Press both of the [MEMORY] buttons to call up the “Registration Memory” display.

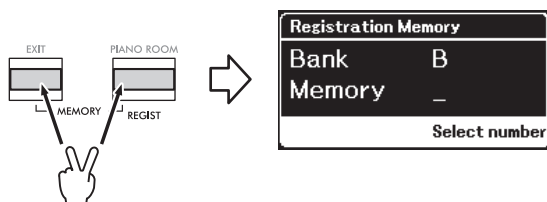

### Parameters that can be saved to Registration Memory

- Voice (page 20)
- Dual (page 29)
- Split (page 30)
- Sound Boost (page 37): On/Off, type
- Master EQ type (page 38), User Master EQ setting (page 39)
- Song tempo (page 47)
- Metronome tempo (page 41)
- Rhythm (page 43)
- Voice menu (all menus, page 95)
- Metronome/Rhythm menu (page 101)
  - Volume
  - Intro
  - Ending
  - Bass
- System menu (page 103)
  - Tuning
  - Keyboard
  - Pedal: Pitch Bend Range, AUX Polarity, Aux assign, Aux Area



- Press the one of the [1]–[6] button which you want to register the setting.

The display for registering the setting.

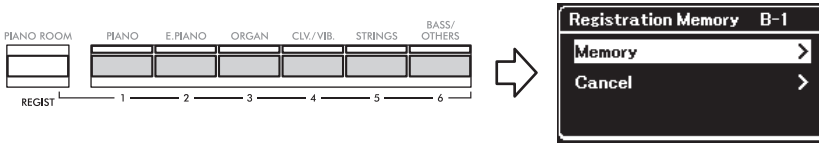

**NOTICE**

If you press a button to which a setting is already registered, new setting will replace already saved setting. If you want to check whether the settings are registered to the corresponding button before register, perform the step 2 in “Recalling a Registered Setting.”

- Press the [▶] button to actually register the setting.

When this operation is completed, “Completed” is shown on the display, and operation returns to the Voice display will be restored after a while.

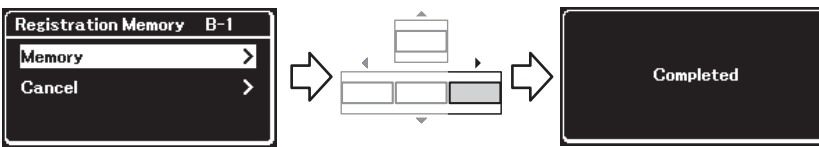

**NOTICE**

If the power is turned off during this operation, the setting registered to the Registration Memory may be lost.

**NOTE**

It is impossible to check the registered settings in the list etc. on this instrument. This is why, we recommend that you make a note of the settings you have registered.

To cancel this operation, press the [▼] button to select “Cancel,” and then press the [▶] button.

## Recalling a Registered Setting

- While holding down the [REGIST] button, use the [▲]/[▼] buttons to select the bank to which the settings are saved.

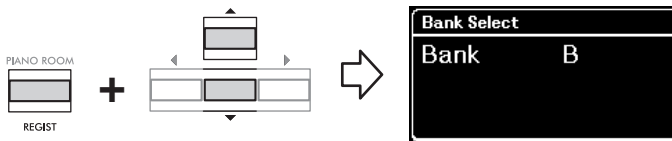

- While holding down the [REGIST] button, press the appropriate [1]–[6] button to which the setting is registered.

The number of the pressed button appears next to “Memory” in the display and the registered setting is recalled.

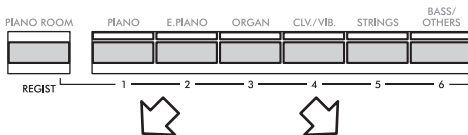

When the setting is registered

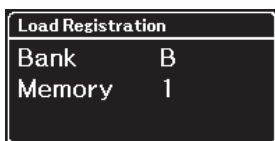

When the setting is not registered

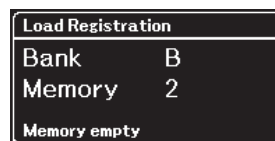

# Connecting to Other Devices

## Connectors

You can connect other devices to this instrument's connectors. For information about location of these connectors, refer to "Panel Controls and Terminals" on page 11.

### Front Panel

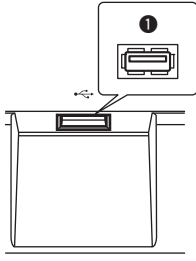

### Rear Panel

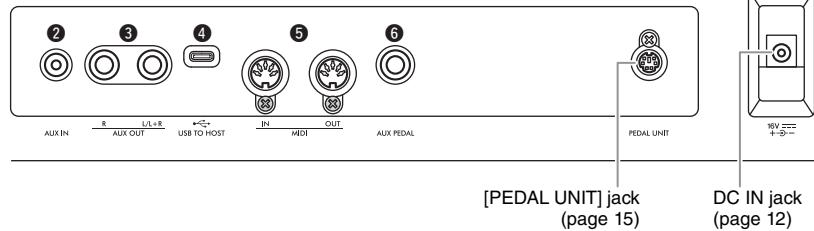

### **CAUTION**

Before connecting the instrument to other electronic components, turn off the power of all the components. Also, before turning any components on or off, make sure to set all volume levels to minimum (0). Otherwise, damage to the components, electrical shock, or even permanent hearing loss may occur.

### **1** [USB TO DEVICE] terminal

You can connect a USB flash drive to this terminal, or use a USB wireless LAN adaptor UD-WL01 (sold separately) to connect with a smart device such as a smartphone. For details, refer to "Connecting USB Devices" (page 75) or "Connecting to a Computer or Smart Device" (page 77). Before using the [USB TO DEVICE] terminal, be sure to read "Precautions when using the [USB TO DEVICE] terminal" on page 75.

### **2** [AUX IN] jack

This jack is used to connect an audio player, such as a smartphone or portable audio player. For details, refer to "Connecting to an Audio Player" on page 76.

### **3** AUX OUT [R] [L/L+R] jacks

These jacks are used to connect to external powered speaker systems (page 76).

### **4** [USB TO HOST] terminal

This terminal allows connection to a computer or a smart device, such as smartphone or tablet. For details, refer to "Connecting to a Computer or Smart Device" (page 77).

### **5** MIDI [IN], [OUT] terminals

These terminals are used to connect external MIDI devices, such as a synthesizer or a sequencer. For details, refer to "Connecting External MIDI Devices" on page 89.

### **6** [AUX PEDAL] jack

An included FC3A foot pedal, or a separately sold FC4A or FC5 foot switch can be connected to this jack. For details on the functions assigned to the pedals, refer to "Pedal Function List" (page 17). To select a different function to be controlled, use "Aux Assign" (page 104) in the "System" menu display.

### **NOTE**

There are two different types of USB terminals on the instrument: [USB TO DEVICE] and [USB TO HOST]. Take care not to confuse the two terminals and the corresponding cable connectors. Be careful to connect the proper plug in the proper direction.

## Connecting USB Devices ([↔]) (USB TO DEVICE) Terminal

You can connect a USB flash drive or a USB wireless LAN adaptor UD-WL01 (sold separately) to the [↔] (USB TO DEVICE) terminal. You can save data you've recorded on the instrument to the USB flash drive (pages 66, 90), or you can connect the instrument to a smart device such as a smartphone via wireless LAN (page 83).

### Precautions when using the [↔] (USB TO DEVICE) terminal

This instrument features a built-in [↔] (USB TO DEVICE) terminal. When connecting a USB device to the terminal, be sure to handle the USB device with care. Follow the important precautions below.

#### NOTE

For more information about the handling of USB devices, refer to the owner's manual of the USB device.

#### ■ Compatible USB devices

- USB flash drive
- USB wireless LAN adaptor UD-WL01 (sold separately; may not be available in some areas)

Other USB devices such as a computer keyboard or mouse cannot be used.

The instrument does not necessarily support all commercially available USB devices. Yamaha cannot guarantee operation of USB devices that you purchase. Before purchasing a USB device for use with this instrument, please visit the following web page:

<https://download.yamaha.com/>

Although USB devices 2.0 to 3.0 can be used on this instrument, the amount of time for saving to or loading from the USB device may differ depending on the type of data or the status of the instrument. USB 1.1 devices cannot be used on this instrument.

#### NOTE

The rating of the [↔] (USB TO DEVICE) terminal is a maximum of 5 V/500 mA. Do not connect USB devices having a rating above this, since this can cause damage to the instrument itself.

#### ■ Connecting a USB device

When connecting a USB device to the [↔] (USB TO DEVICE) terminal, make sure that the connector on the device is appropriate and that it is connected in the proper direction.

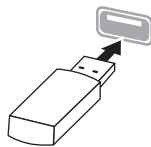

#### NOTICE

- Avoid connecting or disconnecting the USB device during playback/recording and file management operations (such as Save, Copy, Delete and Format), or when accessing the USB device. Failure to observe this may result in "freezing" of the operation of the instrument or corruption of the USB device and the data.
- When connecting then disconnecting the USB device (and vice versa), make sure to wait a few seconds between the two operations.
- Do not use an extension cable when connecting a USB device.

### Using USB Flash Drives

By connecting the instrument to a USB flash drive, you can save data you've created to the connected device, as well as read data from the connected USB flash drive.

#### ■ Number of USB flash drives that can be used

Only one USB storage device can be connected to the [↔] (USB TO DEVICE) terminal.

#### ■ Formatting a USB flash drive

You should format the USB flash drive only with this instrument (page 107). A USB flash drive formatted on another device may not operate properly.

#### NOTE

The format operation overwrites any previously existing data. Make sure that the USB flash drive you are formatting does not contain important data.

#### ■ To protect your data (write-protect)

To prevent important data from being inadvertently erased, apply the write-protect provided with each USB flash drive. If you are saving data to the USB flash drive, make sure to disable write-protect.

#### ■ Turning off the instrument

When turning off the instrument, make sure that the instrument is NOT accessing the USB flash drive by playback/recording or file management (such as during Save, Copy, Delete and Format operations). Failure to do so may corrupt the USB flash drive and the data.

## Connecting to an Audio Player ([AUX IN] jack)

You can connect the headphone jack of an audio player, such as a smartphone or portable audio player, to the instrument's [AUX IN] jack. Audio playback on the connected device is output from the built-in speakers of this instrument.

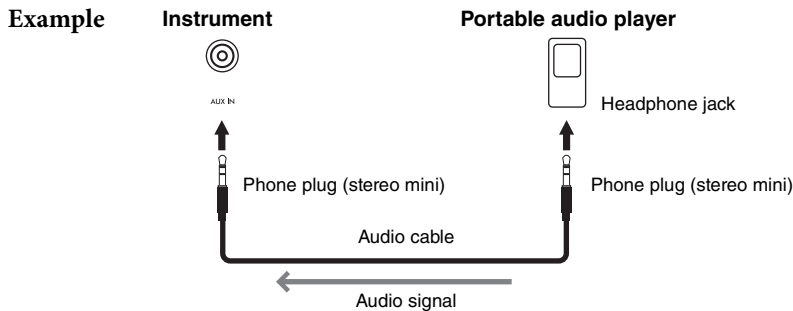

### NOTICE

To avoid damage to the devices, first turn on the power to the external device, and then to the instrument. When turning off the power, first turn off the power to the instrument, and then to the external device.

### NOTE

- The instrument's [VOLUME] setting affects the input signal from the [AUX IN] jack.
- Use audio cables and adaptor plugs having no (zero) resistance.

## Using an External Speaker System for Playback (AUX OUT [L/L+R]/[R] jacks)

These jacks let you connect the instrument to external powered speaker systems, for playing in larger venues at higher volumes.

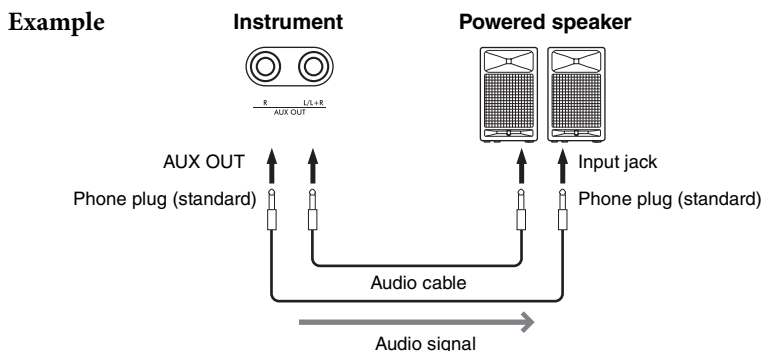

### NOTICE

- To avoid possible damage, first turn on the power to the instrument, then to the external device. When turning off the power, first turn off the power to the external device, then to the instrument. Since this instrument's power may automatically be turned off due to the Auto Power Off function (page 13), turn off the power to the external device, or disable Auto Power Off when you do not intend to operate the instrument.
- Do not route the output from the AUX OUT jacks to the [AUX IN] jack. If you make this connection, the signal input at the [AUX IN] jack is output from the AUX OUT jacks. These connections could result in a feedback loop that will make normal performance impossible, and may even damage the equipment.

The output volume from the AUX OUT jacks can be adjusted by the [VOLUME] slider on the instrument. If you want to mute the speaker of the instrument while the external speakers are connected to the AUX OUT jacks, set the "Speaker" parameter to off via the "System" menu: "Utility" → "Speaker" (page 106).

### NOTE

- Use only the [L/L+R] jack for connection with a monaural device.
- Use audio cables and adaptor plugs having no (zero) resistance.
- When you are monitoring the sound output via the AUX OUT jacks from headphones connected to the instrument, we recommend that you set the Binaural Sampling and Stereophonic Optimizer functions to off. For details, refer to page 14.

## Connecting to a Computer or Smart Device

Connecting a computer or a smart device such as a smartphone or tablet allows you to enjoy the features shown below. The method of connections varies depending on the connected device or your intended use.

- **Transmitting/receiving audio data (USB Audio interface function)**

Connect a computer or a smart device to the [USB TO HOST] terminal via a USB cable. For details, refer to page 78.

- **Listening to audio data from a smart device through this instrument (Bluetooth audio function)**

Connect a smart device and this instrument via Bluetooth. For details, refer to page 79.

- **Using smart device apps by connecting to a smart device**

The two powerful apps, “Smart Pianist” and “Rec'n'Share,” can be used with this instrument.

Refer to page 81 for “Smart Pianist” and page 88 for “Rec'n'Share.”

### Connecting to a computer

By connecting a computer to the [USB TO HOST] terminal via a USB cable, you can transfer MIDI data or Audio data between the instrument and the computer. For instructions on connecting to a computer, refer to page 78.

### Connecting to a Smart Device

The smart device such as a smartphone or tablet can be connected to this instrument via the following methods.

- **Connecting via USB cables**

Connect the smart device to the [USB TO HOST] terminal via USB cables. For details, refer to page 88.

- **Connecting via Bluetooth**

Connect the smart device to this instrument wirelessly via Bluetooth. For details, refer to pages 79 and 82.

- **Connecting via Wi-Fi (by using the USB wireless LAN adaptor)**

Connect the smart device to this instrument via Wi-Fi by using the separately sold USB wireless LAN adaptor, UD-WL01.

For details, refer to page 83.

\*The USB wireless LAN adaptor UD-WL01 may not be available depending on your area.

**NOTICE**

Do not place your smart device in an unstable position. Doing so may cause the device to fall and result in damage.

## Transmitting/Receiving Audio Data (USB Audio Interface Function)

By connecting a computer or a smart device to the [USB TO HOST] terminal via a USB cable shown in the illustration, digital audio data can be transmitted/received. This USB Audio Interface function provides the following advantages:

- **Playing back audio data with high sound quality**  
This gives you direct, clear sound in which the sound quality has less noise and deterioration than that from the [AUX IN] jack.
- **Recording performance on the instrument as audio data by using a recording software or a music production software**  
The recorded audio data can be played back on the computer or smart device.

**Example:**

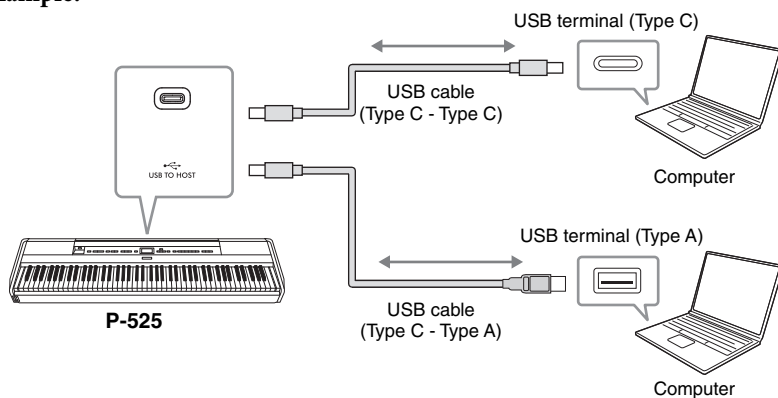

## Audio Loopback On/Off

This allows you to set whether audio sound input from the connected computer or smart device, via the USB audio interface function, or Bluetooth Audio (page 79) / wireless LAN (page 83) / [AUX IN] jack (page 76), is output to a computer or a smart device or not along with the performance played on the instrument. To output the audio input sound, set the Audio Loopback to “On.” However, input sounds via Bluetooth Audio or [AUX IN] jack are always output regardless of this Audio Loopback on/off setting.

For example, if you want to record the audio input sound as well as the sound played on the instrument by using the computer or the smart device, set this to “On.” If you intend to record only the sound played on the instrument by using the computer or the smart device, set this to “Off.”

For details on the settings, refer to “Audio Loopback” on page 106.

### NOTE

- When transmitting or receiving audio signals by using a computer running Windows, the Yamaha Steinberg USB Driver should be installed to the computer.
- The volume of the audio sound input can be adjusted from a computer or smart device.
- When using a USB cable to connect the instrument to your computer, make the connections directly without passing through a USB hub.
- Unexpected sounds may occur if you edit MIDI data related to the Grand Expression Modeling (page 25) on a computer.

### NOTICE

- Use an CC or AC type USB cable of less than 3 meters. The cable must be a communication cable compliant with USB standards, and not a charging-only cable.
- If you are using a DAW (digital audio workstation) application with this instrument, set the Audio Loopback function to off. Otherwise, a loud sound may occur, depending on the settings of the computer.

### NOTE

- The audio input sounds are not output to devices connected via the Bluetooth Audio or [AUX IN] jack.
- The playback sound of an Audio Song (page 44) is also output to a computer or smart device when this is set to “On,” while the sound is not output when this is set to “Off.”
- With Audio Recording (page 54), the audio input sound from the connected computer or smart device is recorded when this is set to “On,” while the sound is not recorded when this is set to “Off.” However, when the devices are connected via the Bluetooth Audio or [AUX IN] jack, the input sounds are always recorded regardless of the Audio Loopback on/off setting.

## Listening to Audio Data from a Smart Device through this Instrument (Bluetooth Audio Function)

Before using the Bluetooth function, be sure to read “About Bluetooth” on page 80.

You can input the sound of the audio data saved in a Bluetooth-equipped device, such as a smart phone or digital audio player, to this instrument and listen to it through the built-in speaker of the instrument.

To use this function, make sure that Bluetooth is set to “On” (page 80) on the instrument (default setting: On).

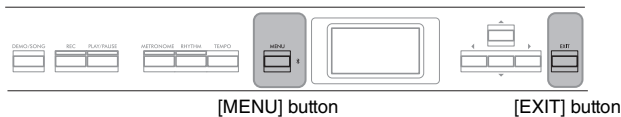

### 1. Hold down the [MENU] button for 3 seconds.

The pop-up window will appear which indicates that the instrument is standing by for pairing.



To cancel the pairing, press the [EXIT] button.

### 2. On the smart device, set the Bluetooth function to on and select “P-525 AUDIO” from the connection list.

For details, refer to the smart device owner’s manual.

After pairing is completed, the connection status will be shown in the display.



### 3. Play back audio data on the smart device to confirm that the built-in speakers of the instrument can output the audio sound.

When you turn on the instrument the next time, the last-connected smart device will be connected to this instrument automatically, if the Bluetooth function of the smart device and the instrument is set to on. If it is not connected automatically, select the model name of the instrument from the connection list on the smart device.

#### NOTE

- In this manual, a smart device is used as an example of a Bluetooth-equipped device which allows Bluetooth transmission of contained audio data to the instrument, via wireless communication. For proper operation, the device must be compatible with A2DP (Advanced Audio Distribution Profile). The Bluetooth Audio function is explained here by using a smart device as an example of such Bluetooth-equipped devices.
- Refer to page 82 for transmitting/receiving the MIDI data between the instrument and the smart device via Bluetooth.
- Bluetooth headphones or speakers cannot be paired.

#### Pairing

“Pairing” means to register Bluetooth-equipped smart devices on this instrument, and establish the mutual recognition for wireless communication between the two.

#### NOTE

- Only one smart device can be connected to this instrument at a time (although up to 8 smart devices can be paired to this instrument). When pairing with the 9th smart device has succeeded, pairing data for the device with the oldest connection date will be deleted.
- Make sure to complete the settings on the smart device within 5 minutes.
- If you are required to enter a passkey, enter the numerals “0000.”

#### NOTE

You can adjust the volume of the sound input via Bluetooth by the [VOLUME] slider. To adjust the volume balance between your keyboard performance and the input sound via Bluetooth, adjust the volume on the smart device.

## Switching the Bluetooth Function On/Off

Before using the Bluetooth function, be sure to read “About Bluetooth” (see below).

By default, the Bluetooth function will be on right after turning the instrument’s power on, however you can set the function to off.

1. Press the [MENU] button repeatedly to call up the “System” menu display, then select the highlighted item in each display as illustrated below.

“System” menu display

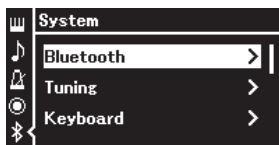

“Bluetooth” display

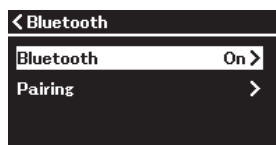

- 1-1. Confirm that “Bluetooth” is selected.
- 1-2. Press the [▶] button to call up the next display.

- 1-3. Confirm that “Bluetooth” is selected.

2. Press the [▶] button to switch on/off.

To exit from the “System” menu display, press the [EXIT] button.

## About Bluetooth

### Bluetooth capability

Depending on the country in which you purchased the product, the instrument may not have Bluetooth capability. If the Bluetooth logo is printed on the front panel, this means that the product is equipped with Bluetooth functionality.

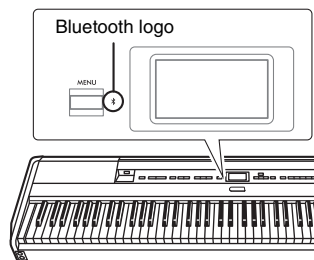

Bluetooth is a technology for wireless communication between devices within an area of about 10 meters (33 ft.) employing the 2.4 GHz frequency band.

### Handling Bluetooth communications

- The 2.4 GHz band used by Bluetooth compatible devices is a radio band shared by many types of equipment. While Bluetooth compatible devices use a technology minimizing the influence of other components using the same radio band, such influence may reduce the speed or distance of communications and in some cases interrupt communications.
- The speed of signal transfer and the distance at which communication is possible differs according to the distance between the communicating devices, the presence of obstacles, radio wave conditions and the type of equipment.
- Yamaha does not guarantee all wireless connections between this unit and devices compatible with Bluetooth function.



## Using Smart Device Apps with a Connected Smart Device

You can use the two smart device apps, “Smart Pianist” and “Rec'n'Share” (page 88) by connecting a smart device such as a smartphone or tablet.

For details on each app, access the website below and visit the page for each app.



<https://www.yamaha.com/2/apps/>

## Operating the Instrument with a Smart Device (Smart Pianist)

By using the Smart Pianist app, you can view the score of the preset Songs on the smart device, record your performance to the smart device, and perform other convenient operations. The intuitive visual also helps you easily to confirm the current settings of the instrument.

After installing the “Smart Pianist” app on your smart device from the website above, connect this instrument to the device via the following three methods.

- Connecting via Bluetooth (page 82)
- Connecting via USB cables (page 82)
- Connecting via Wi-Fi (by using the separately sold UD-WL01 wireless LAN adaptor) (page 83)

The “Connection Wizard” of Smart Pianist guides you in properly connecting the smart device to the instrument properly.

For more information on how to connect the device and use the app, refer to the “Smart Pianist User Guide” on the following website.



<https://manual.yamaha.com/mi/app/smartpianist/>

### NOTICE

- **Activating the “Smart Pianist” app while the instrument is connected to the smart device overwrites the settings on the instrument by that of “Smart Pianist.” Save your important setup data as a backup file to a USB flash drive (page 90).**
- **Do not place your smart device in an unstable position. Doing so may cause the device to fall and result in damage.**

### NOTE

When using the “Smart Pianist” app, you cannot use any buttons on the instrument other than the [EXIT] button. Control the instrument by using “Smart Pianist.” Pressing the [EXIT] button on the instrument disconnects the instrument from the “Smart Pianist” app, and enables you to control the instrument by using its buttons.

## ■ Connecting via Bluetooth

Before using the Bluetooth function, be sure to read “About Bluetooth” on page 80.

Two different types of Bluetooth connection are available: “Bluetooth MIDI” and “Bluetooth Audio” (page 79).

Although a Bluetooth MIDI connection is required for using the Smart Pianist, a Bluetooth Audio connection is also required for playing back audio data in your smart device on the Smart Pianist. Connect via Bluetooth Audio first, and then connect via Bluetooth MIDI.

1. **Make the Bluetooth Audio function settings on this instrument to receive audio data (page 79).**
2. **Connect with the smart device via Bluetooth MIDI by using the “Connection Wizard” on the Smart Pianist.**

When connecting, select “P-525 MIDI” on Smart Pianist as the device for connection.

When the Bluetooth connection is made successfully, the connection status is shown on the Voice display.

### “Voice” display

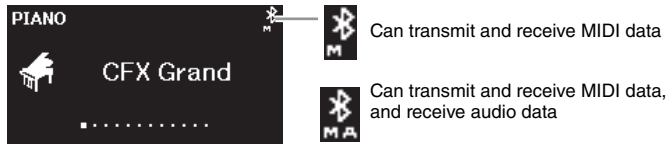

### NOTE

If the Bluetooth function of this instrument is set to Off (default setting: On), the Bluetooth connection cannot be made. For information on the setting, refer to page 80.

## ■ Connecting via USB cables

Connect the smart device to the [USB TO HOST] terminal via USB cables.

With this method, audio data as well as MIDI data can be transmitted or received between the instrument and the smart device. This allows you to play the audio data in the smart device through Smart Pianist, and also allows you to record your keyboard performance as audio format on Smart Pianist.

For instructions on how to connect a smart device to this instrument, refer to the example on page 88.

## ■ Connecting via Wi-Fi (by using the separately sold USB wireless LAN adaptor)

\*The USB wireless LAN adaptor UD-WL01 may not be available depending on your area.

Connect the smart device via Wi-Fi by connecting the USB wireless LAN adaptor UD-WL01 (sold separately) to the [] (USB TO DEVICE) terminal. With this method, audio data as well as MIDI data can be transmitted or received between the instrument and the smart device. This allows you to play the audio data in the smart device through Smart Pianist, and also allows you to record your keyboard performance as audio format on Smart Pianist.

There are two types of connections via Wi-Fi as described below. The “Connection Wizard” of Smart Pianist guides you in properly connecting the smart device to the instrument properly.

### Connecting by the Infrastructure mode

The Infrastructure mode uses an access point for data communication between a USB wireless LAN adaptor and a network. You can use this mode when you connect to another network while a smart device is connected to the instrument.

- Displaying the Wireless LAN networks and connecting to a network (page 84)
- Automatic Setup by WPS (page 85)
- Manual Setup (page 85)

### Connecting by the Accesspoint mode (page 87)

The Accesspoint mode allows you to directly connect the USB wireless LAN adaptor and a smart device, without the need for using an access point. You can use this mode when no access point is available for connection to the instrument, or when it is unnecessary to connect to another network while a smart device is connected to the instrument.

When connected by this mode, Internet access is disabled on your smart device, and some functions of Smart Pianist cannot be used.

#### **NOTICE**

Do not connect this product to a public Wi-Fi and/or Internet service directly. Only connect this product to the Internet through a router with strong password protections. Consult your router manufacturer for information on optimum security practices.

## • Displaying the Wireless LAN Networks and connecting to a Network

Make sure to connect the USB wireless LAN adaptor (sold separately) to the [↔] (USB TO DEVICE) terminal, otherwise the displays for setup below will not be shown.



[MENU] button                      [▲]/[▼]/[◀]/[▶] buttons

**NOTE**

If the menus shown in the Wireless LAN display are different from the instruction here, the instrument is in the Accesspoint mode. Set the Wireless LAN Mode parameter to “Infrastructure Mode” by following the step 1 on page 87.

### 1. Press the [MENU] button repeatedly to call up the “System” menu display, and then select the highlighted item in each display as illustrated below.

“System” menu display

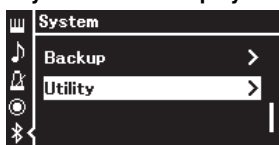

- 1-1. Use the [▲]/[▼] buttons to select “Utility.”
- 1-2. Press the [▶] button to call up the next display.

“Utility” display

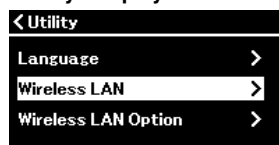

- 1-3. Use the [▲]/[▼] buttons to select “Wireless LAN.”
- 1-4. Press the [▶] button to call up the next display.

“Wireless LAN” display

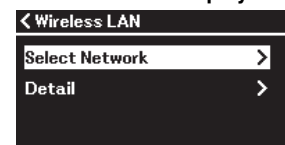

- 1-5. Use the [▲]/[▼] buttons to select “Select Network.”

### 2. Press the [▶] button to call up the network list.

For a network with a lock icon , you need to enter the proper password.

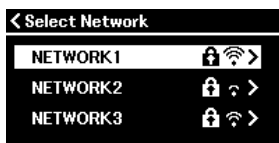

**NOTE**

If no signal from the access point is received, the access point cannot be listed. Also, closed access points cannot be listed.

### 3. Connect the instrument to the Network.

#### 3-1. Select the desired network, then press the [▶] button.

The name of the selected network will be fully shown in the display, letting you confirm this is the network you want to use.

#### 3-2. Press the [▶] button.

- **For a network without a lock icon:**  
Connecting starts.
- **For a network with a lock icon:**  
You need to enter the proper password. For details on how to enter characters, refer to the “Renaming Files — Rename” on page 71. After entering the password, press the [MENU] button to finalize the setting. This operation starts connecting automatically.

When connection is done successfully, “Completed” is shown in the display, and returns to the “Select Network” display.

#### 4. Connect the smart device to the access point.

Open the Wi-Fi settings on your smart device, and select the network containing “P-525” in the name field.

If a password is requested, input it to connect.

#### • Automatic Setup by WPS

Please make sure to connect the USB wireless LAN adaptor (sold separately) to the [↔] (USB TO DEVICE) terminal, otherwise the displays for setup will not be shown.

If your access point supports WPS, you can easily connect the instrument to access point by WPS, without making settings, such as password input, etc. Press the WPS button on the USB wireless LAN adaptor more than 3 seconds, and press the WPS button on your access point within two minutes. When connection is done successfully, “Completed” is shown in the display, and the Voice display will be shown.

Finally, connect the smart device to the access point (step 4 above).

#### • Manual Setup

Make sure to connect the USB wireless LAN adaptor (sold separately) to the [↔] (USB TO DEVICE) terminal, otherwise the displays for setup will not be shown.

1. To call up the network list, perform steps 1 – 2 in the “Displaying the Wireless LAN Networks and connecting to a Network” (page 84).

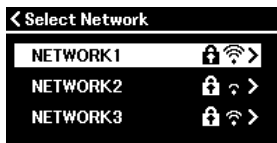

2. Select “Other” at the bottom of the network list, then press the [▶] button.

#### NOTE

WPS setup is not available while the instrument is in the following modes or conditions:

- While a Song or a Demo Song is playing back or being paused temporarily, or while the instrument is in the Song Recording mode.
- When Wireless LAN mode is set to “Accesspoint Mode” in the “System” menu.

### 3. Set the SSID, Security and Password to the same as the settings on the access point.



#### 3-1. Select the “SSID” then press the [▶] button to call up the display for SSID input, then enter the SSID.

For details on how to enter the characters, refer to “Renaming Files — Rename” on page 71. After entering the SSID, press the [MENU] button to finalize the setting. Operation returns to the “Other” display.

#### 3-2. Select “Security” then press the [▶] button to call up the Security list. Select the security then return to the “Other” display by pressing the [◀] button.

#### 3-3. Select “Password,” then set the password in the same way as SSID.

### 4. Select “Connect >” at the bottom of the display shown in step 3, then press the [▶] button to start connecting.

When connection is done successfully, “Completed” is shown in the display, and returns to the “Select Network” display.

### 5. Connect the smart device to the access point.

This operation is the same as step 4 on page 85.

#### NOTE

The password cannot be set when you select “NONE” for the security setting.

## • Connecting by the Accesspoint Mode

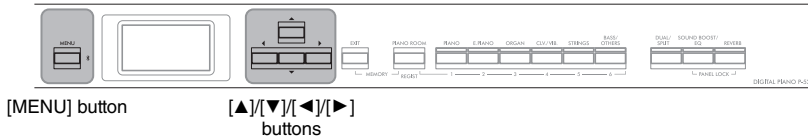

### 1. Switch the instrument to the “Accesspoint Mode.”

Press the [MENU] button repeatedly to call up the “System” menu display, then select the highlighted item in each display as illustrated below.

#### “System” menu display

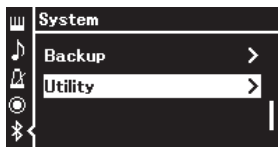

#### “Utility” display

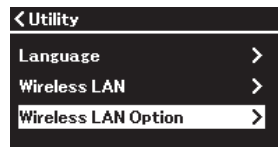

- 1-1. Use the [▲]/[▼] buttons to select “Utility.”  
1-2. Press the [▶] button to call up the next display.

- 1-3. Use the [▲]/[▼] buttons to select “Wireless LAN Option.”  
1-4. Press the [▶] button to call up the next display.

#### “Wireless LAN Option” display

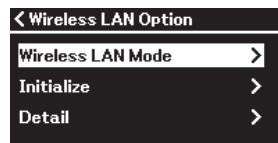

#### “Wireless LAN Mode” display

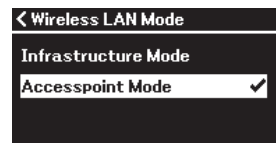

- 1-5. Use the [▲]/[▼] buttons to select “Wireless LAN Mode.”  
1-6. Press the [▶] button to call up the next display.

- 1-7. Use the [▲]/[▼] buttons to select “Accesspoint Mode.”

When mode change is done successfully, “Completed” is shown in the display, operation returns to the “Wireless LAN Mode” display.

### 2. Set SSID, Security, Password and Channel.

- 2-1. From the “System” menu display, select the highlighted item in each display as illustrated below.

#### “System” menu display

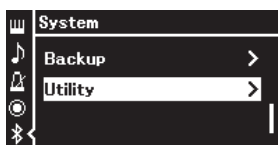

#### “Utility” display

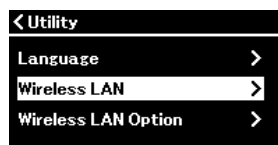

#### “Wireless LAN” display

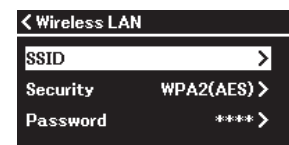

#### 2-2. Set the SSID, Security, Password and Channel.

Select and enter each value/setting in the same way as in step 3 in “Manual Setup.” For the setting range for each item, refer to “Wireless LAN” (In the Accesspoint mode) on page 108.

### 3. Save the setting.

Select “Save >” at the bottom of the “Wireless LAN” display, then press the [▶] button to start saving.

When saving is done successfully, “Completed” is shown in the display, and operation returns to the “Utility” display.

### 4. Connect the smart device to the instrument (as an access point).

This operation is the same as step 4 on page 85.

## Filming, Recording, and Editing Your Performance (Rec'n'Share)

Rec'n'Share is a smart device app which allows you to film, record, and edit your performance and helps in uploading the edited data to SNS, etc. For instructions on how to obtain it, refer to page 81.

To use Rec'n'Share, connect this instrument to your smart device with a commercially available USB cable (CC or AC type) or a USB conversion adaptor that matches the connector shape.

#### Example

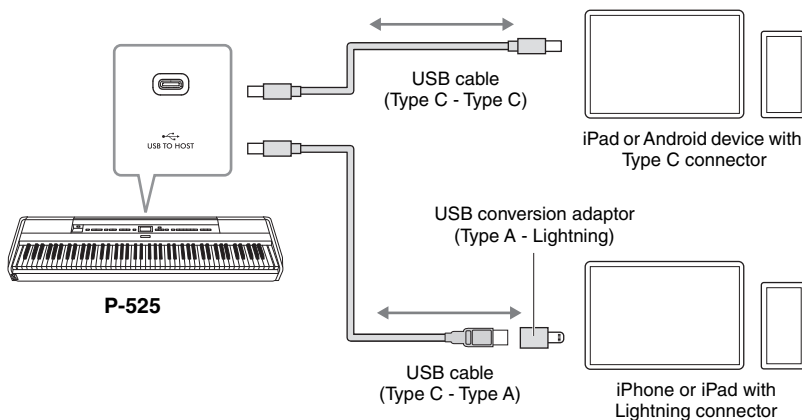

#### **NOTICE**

Use a CC or AC type USB cable of less than 3 meters. The cable must be a communication cable compliant with USB standards, and not a charging-only cable.



## Connecting External MIDI Devices (MIDI Terminals)

The sophisticated MIDI functions give you powerful tools to expand your music performance and creation possibilities. Use the MIDI terminals and standard MIDI cables to connect external MIDI devices (keyboard, sequencer, etc.)

- **MIDI [IN]:** Receives MIDI messages from another MIDI device.
- **MIDI [OUT]:** Transmits MIDI messages generated on this instrument to another MIDI device.

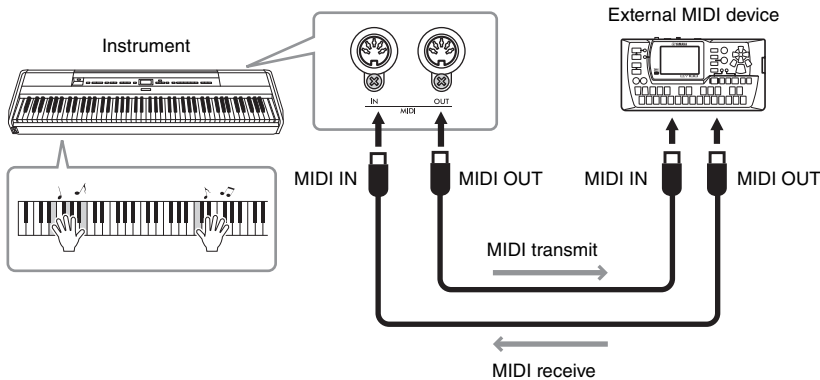

### ⚠ CAUTION

**Before connecting the instrument to other MIDI devices, turn off the power of all the components.**

### NOTE

- For details about MIDI, refer to "MIDI Basics" downloadable from the Yamaha website (page 6).
- Since MIDI data that can be transmitted or received varies depending on the type of MIDI device, check the MIDI Data Format to find out what MIDI data and commands your devices can transmit or receive. The MIDI Data Format is contained in the "Data List" downloadable from the Yamaha website (page 6).
- When transmitting MIDI data from this instrument to an external MIDI device, unexpected sounds may occur because of data related to the Grand Expression Modeling.

# Backup and Initialization

## ■ Backup Setting

(Selecting parameters maintained even when the power is turned off)

This lets you set whether some settings of the Backup Setting (below) are maintained or not when the power is turned off. The Backup Setting consists of two groups, “Voice” (including Voice related settings such as Voice selection) and “Other” (including various settings such as Song Repeat and Tuning), which can be set individually.

### Data and settings maintained even when the power is turned off

- MIDI Song saved in “User” category (page 45)
- “System” menu (page 103)
  - Bluetooth\* On/Off
  - Keyboard (Duo Type only)
  - Utility
- Backup Setting (explained here)
- Registration Memory (page 72)

\* For information on whether Bluetooth functionality is included with the instrument or not, refer to page 80.

1. Press the [MENU] button several times to select “System” menu.
2. Use the [▲]/[▼] buttons to select “Backup,” use the [▶] button to call up the next display, then press the [▲] button to select “Backup Setting.”
3. Use the [▶] button to call up the next display, select “Voice,” then use the [▶] button to select “On” or “Off.”  
Each “Voice” contains the following settings:
  - Voice selection for R1, R2 and L
  - All the parameters other than Transpose in the “Voice” menu
4. Press the [▼] button to select “Other,” then use the [▶] button to select “On” or “Off.”  
The “Other” contains the following settings:
  - “Song” menu (page 98): Song Repeat, Volume (Song-Keyboard), Audio Volume, Quick Play, Play Track
  - “Metronome/Rhythm” menu (page 101): Volume, BPM, Bell On/Off, Intro, Ending, Bass

- “System” menu (page 103): Tuning, Keyboard (except “Duo” and “Duo Type”), Pedal, Sound, MIDI
- Sound Boost, Master EQ

5. Press the [EXIT] button to exit from the “System” menu display.

## ■ Backup

(Saving the Backup file for internal data)

This lets you save data on internal memory to the connected USB flash drive as a backup file (named “p-525.bup”). This backup file can be loaded to the instrument via the Restore function (page 91) for future. Note that Registration Memory (page 72) is not included in the backup file.

### NOTICE

- It may take 1–2 minutes to complete this operation. Never turn off the power during this operation (while “Executing” is shown). Doing so could result in damage to the data.
- If the same backup file (p-525.bup) is already saved in the USB flash drive, this operation will overwrite or replace this file with new one.

1. Connect the USB flash drive to the [  ] (USB TO DEVICE) terminal.
2. Press the [MENU] button several times to select “System” menu.
3. Use the [▲]/[▼] buttons to select “Backup,” use the [▶] button to call up the next display, then use the [▲]/[▼] buttons to select “Backup.”
4. Use the [▶] button to call up the next display, then press the [▼] button to select “Execute.”
5. Press the [▶] button to execute the Backup operation.
6. Press the [EXIT] button to exit from the “System” menu display.

### NOTE

When you want to restore the settings in the backup file, execute the Restore function (page 91).

## ■ Restore

(Restarting the instrument with the Backup file loaded)

This lets you load the backup file (p-525.bup) saved via the Backup function (page 90) to the instrument on.

### NOTICE

- It may take 1 – 2 minutes to complete this operation. Never turn off the power during this operation (while “Executing” is shown). Doing so could result in damage to the data.
- If recorded Songs reside on “User” memory, make sure to move the Songs to the USB flash drive by following the instructions page 69 before executing this operation. If you do not, the Songs will be deleted via this operation.

1. Connect the USB flash drive containing the Backup file to the [  ] (USB TO DEVICE) terminal.
2. Press the [MENU] button several times to select “System” menu.
3. Use the [▲]/[▼] buttons to select “Backup,” use the [▶] button to call up the next display, then use the [▲]/[▼] buttons to select “Restore.”
4. Use the [▶] button to call up the next display, then press the [▼] button select “Execute.”
5. Press the [▶] button to execute the Restore operation.

A message indicating that the operation is completed appears, then the instrument will restart after a while.

## ■ Factory Reset

(Restarting the instrument with the initial factory settings loaded)

This lets you reset the Backup settings (page 90) to their factory defaults (the initial settings preprogrammed when shipped from the factory), which are called up when you first turn on the power to this instrument.

### The following settings are not reset.

- MIDI Song saved in the User category (page 45).
- Bluetooth\* pairing information (page 79).
- Registration Memory (page 72)

\* For information on whether Bluetooth functionality is included with the instrument or not, refer to page 80.

### NOTICE

Never turn off the power during this operation (while “Factory reset executing” is shown). Doing so could result in damage to the data.

1. Press the [MENU] button several times to select “System” menu.
2. Use the [▲]/[▼] buttons to select “Backup,” use the [▶] button to call up the next display, then use the [▲]/[▼] buttons to select “Factory Reset.”
3. Use the [▶] button to call up the next display, then press the [▼] button to select “Execute.”
4. Press the [▶] button to execute the Restore operation.

A message indicating that the operation is completed appears, then the instrument will restart after a while.

### ● Alternate method for restoring the default settings

Press and hold down the white key on the right end (C7) and press the [⏻] (Standby/On) switch to turn on the power to this instrument. This operation will not delete any Songs in the User category, Bluetooth pairing information, and Registration Memory.

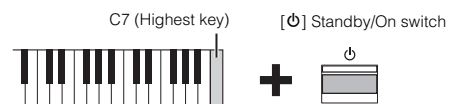

### Restoring all data and settings to their factory defaults—All Memory Clear

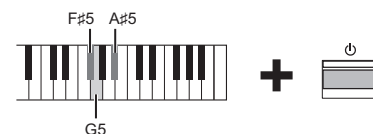

While holding down the F#5, G5 and A#5 keys together of the, press the [⏻] (Standby/On) switch to reset the following data in addition to the Backup Settings to the factory default settings.

- MIDI Song saved in “User” category
- Bluetooth pairing information
- Registration memory

### NOTICE

This operation deletes all data in this instrument. If you have important data in the instrument that you do not want to delete, copy and save them to a USB flash drive, etc. (page 90) before performing this operation.

# Performing Live

Your instrument features a number of convenient functions for use when setting it up on stage in order to perform live. In order to provide a practical description of the connections and settings required in this type of situation.

## Stage setup and signal flow

The sound from your instrument will be sent to a PA mixer, then the mixed sound is amplified and sent to the front-of house speakers so that the audience can hear it. Monitor speakers may be placed on the floor in front of the musicians so that they can more clearly hear their own sound and that of the other instruments.

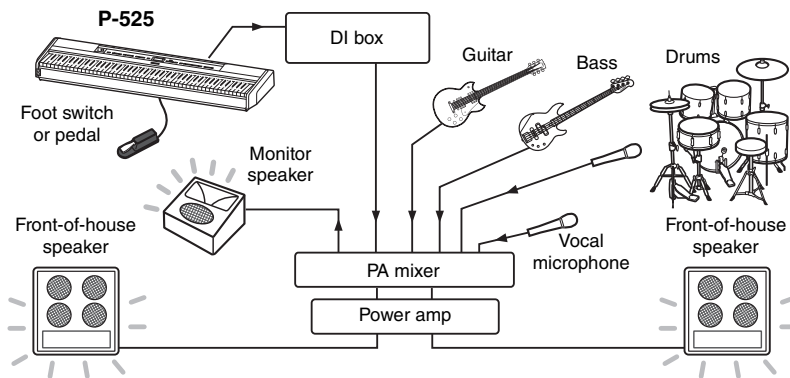

### NOTICE

Please read the following before setting up.

- Ensure that the instrument is turned off before making any connections.
- Make sure to check with the PA operator when connecting or disconnecting cables or turning on/off. Failure to do so may damage to the PA system.

### ■ Connect your footswitch/foot pedal, or pedal unit.

For details on using foot pedal/footswitch or pedal unit and the functions that can be assigned to each pedal, refer to page 15.

### ■ Connect the instrument's output to the PA mixer.

In order to be heard, your instrument will need to be connected to the PA mixer's inputs. Normally, this connection is made via a DI box (direct box) located onstage. Connect the AUX OUT [R] and [L/L+R] jacks on the instrument's rear panel to the DI box inputs using commercially available standard mono audio cables.

- 1 Set the [VOLUME] slider to the MIN position.
- 2 Check with the PA operator whether you can connect the instrument to the PA mixer or not.
- 3 Connect the instrument as the following illustration.

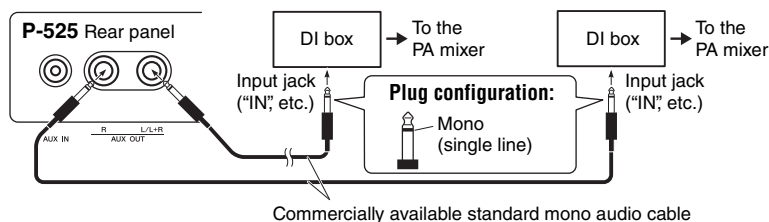

Your instrument should now be fully connected. The next step will be to balance your performance sounds.

### NOTE

- When playing the piano sound of this instrument with an external powered speaker, and while monitoring the sound output from this instrument on connected headphones, we recommend that you set the "Binaural Sampling" or "Stereophonic Optimizer" functions to "OFF" (page 14).
- If only one of the DI box channels is available for use with your instrument, connect it to the AUX OUT [L/L+R] jack using a standard mono audio cable. In this configuration, your left and right signals will be mixed and output from the instrument in mono.
- If DI boxes are not being used, connect the AUX OUT [R] and [L/L+R] jacks to the input jacks on the PA mixer or an on-stage sub-mixer.

## Sound setup

Once all of the instruments and microphones have been connected, the PA operator will ask each musician in turn to play his or her instrument. You should get ready as follows.

### ■ Turn on your instrument.

Set the [VOLUME] slider to the MIN position. Check with the PA operator whether you can turn on the instrument, then press the [⏻] (Standby/On) switch.

### ■ Check your settings.

- Once turned on, ensure that your instrument is set up as follows.
  - Tuned to match the other instruments (Master tuning, page 35).
  - Auto Power-Off function disabled (page 13).
  - Footswitch or foot pedal is operating correctly as an assigned function (page 17).
  - Reverb is turned off (page 26).
- Turn off the speaker sound of your instrument (page 106) as necessary.
- Recall the settings saved to Registration Memory (page 72) as necessary.

### ■ Determine the optimum levels.

When asked by the PA operator to output a sound, play the digital piano as you would when performing and determine the best settings for the following.

- Volume when you are playing accompaniment
- Volume when you are playing loudest, such as during a keyboard solo
- Volume of each Voice to be used

### Master Volume Setting

Roughly speaking, the [VOLUME] slider should be set between 5 and 7 for playing accompaniment and to 8 or 9 when you need to play louder. If set too high, your sound may become distorted; if too low, any background noise will be more noticeable.

### Sound Boost (page 37) Setting

Turn on the Sound Boost function if you are finding it difficult to make your instrument heard within the overall mix. Choose from three different Sound Boost types.

### Master EQ (page 38) Setting

The Master EQ function may help in making the optimum sound for performing live.

### ■ Balance the overall sound of the band.

After the levels of the various instruments have been set, the PA operator will have everyone play together in order to balance the overall sound of the band. At this time, you should listen to the nearest monitor speaker and ensure that you can hear everything you need to in order to play well. If, for example, you cannot hear your own sound, the singer, or another instrument well enough, ask the PA operator to raise the corresponding level in your monitor's mix.

**This completes the setup process. You should now be ready to play live.**

#### Lock the front panel to prevent mistakes.

Your instrument's Panel Lock function allows you to temporarily disable front panel buttons to prevent them being operated unintentionally while performing. For details on this function, refer to page 40.

# Detailed Settings (MENU Display)

Pressing the [MENU] button opens one of the five menu displays (Voice, Song, Metronome/Rhythm, Recording and System). You can make settings for various functions from these menu displays.

## Common Operations in the Menu Displays

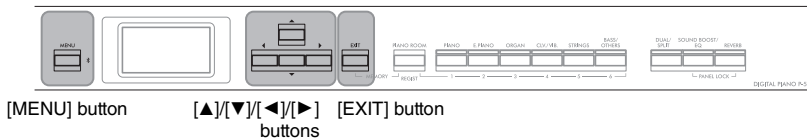

### 1. As necessary, select the desired Voice or Song for editing.

- If you want to edit Voice-related parameters (by calling up the “Voice” menu), select a Voice.
- If you want to edit parameters related to the R1/R2/L voice (pages 29-32), such as volume balance, turn on Dual/Split/Duo, then select the desired Voices.
- If you want to set Song playback parameters, such as Repeat, select a Song.
- If you want to edit your recorded MIDI Song data select the recorded MIDI Song.

### 2. Press the [MENU] button several times to select the desired menu.

Pressing the [MENU] button repeatedly will call up the following menu displays in order, according to the vertical menu at the left of the display.

- Voice menu (page 95)
- Song menu (page 98)
- Metronome/Rhythm menu (page 101)
- Recording menu (page 102)
- System menu (page 103)

### 3. Use the [▲]/[▼]/[◀]/[▶] buttons to select the desired parameter.

While referring as needed to the parameter list on each page listed in step 2, use the [▲]/[▼] buttons to navigate through the display vertically and use the [◀]/[▶] buttons to navigate through display horizontally.

	[▶] [◀]	[▶] [◀]	[▶] [◀]
L/R*	R, L, Other	-	
Repeat	A - B*	(Setting displ.)	
	Phrase*	Phrase Mark	

### 4. In the display called up in step 3, select a value or execute the operation.

Most displays allow you to select a value by simply using the [▲]/[▼] buttons, although some, such as Edit in the “Song” menu and Backup in the “System” menu, let you execute an operation.

If a pop-up window is shown, set the value with the [◀]/[▶] buttons, then exit from the window using the [EXIT] button.

Also, when the selected parameter provides only two options (on and off, for example), simply pressing the [▶] button will alternate the value between the two options.

Pop-up display



### 5. To exit from the menu display, press the [EXIT] button.



## Voice Menu

This menu lets you edit or set various parameters related to keyboard performance, such as Voice parameters. By turning on Dual/Split/Duo, you can make the settings for each Voice or each Voice combination. While playing the keyboard and hearing the sound, change a parameter value to find your desired sound. Note that you should turn on Dual/Split/Duo before calling up the “Voice” menu display.

### NOTE

Parameters with \* are shown only when Dual/Split/Duo is on.

<b>To call up the desired parameter:</b>					
Turn on Dual, Split or Duo as necessary, select Voices as necessary, press the [MENU] button several times to select “Voice” menu, then use the [▲]/[▼]/[◀]/[▶] buttons to select the desired parameter.					
[▶] [◀]	[▶] [◀]	[▶] [◀]	Description	Default setting	Setting range
Transpose	(Pop-up window)	–	Refer to the description of “Transposing the Pitch in Semitones (Transpose)” on page 34.		
Piano Setting	Lid Position	(Setting display)	Refer to the description of “Lid Position” on page 24.		
	VRM	–	Refer to the description of “VRM” on page 24. Demo cannot be played in “Voice” menu.		
	Damper Res. (Resonance)	(Setting display)	<b>NOTE</b> VRM is effective only for Voices in the Piano group (page 110).		
	Damper Noise	–			
	String Res. (Resonance)	(Setting display)			
	Duplex Scale Res. (Resonance)	(Setting display)			
	Body Res. (Resonance)	(Setting display)			
Grand Exp. (Expression)	–	Refer to the description of “Grand Expression” on page 25. Demo cannot be played in “Voice” menu.			
			<b>NOTE</b> Grand Expression Modeling is effective only for the “CFX Grand” Voice.		
Reverb	(Setting display)	–	Refer to the description of “Reverb” on page 26.		
Chorus	(Setting display)	–	Refer to the description of “Chorus” on page 27.		
Voice Edit	(Voice names)*	Octave	Shifts the pitch of the keyboard up and down in octave steps. This parameter can be set for each Voices when Dual/Split/Duo is on.	Differs depending on the Voice or Voice combination.	–2 (two octaves lower) – 0 (no pitch shift) – +2 (two octaves higher)
		Volume	Adjusts the volume for each of the R1/R2/L Voices. This lets you adjust the balance between the R1/R2/L Voices when Dual/Split/Duo is on.	Differs depending on the Voice or Voice combination.	0 – 127

<b>To call up the desired parameter:</b> Turn on Dual, Split or Duo as necessary, select Voices as necessary, press the [MENU] button several times to select "Voice" menu, then use the [▲]/[▼]/[◀]/[▶] buttons to select the desired parameter.						
[▶] [◀]	[▶] [◀]	[▶] [◀]	Description	Default setting	Setting range	
Voice Edit	(Voice names)*	Reverb Depth (page 26)	Adjusts the Reverb depth for each of the R1/R2/L Voices. This lets you adjust the balance between the R1/R2/L Voices when Dual/Split/Duo is on. The "0" setting will produce no effect.  <b>NOTE</b> When a VRM Voice is used for several parts simultaneously, unexpected sounds may result since the Reverb depth for a part which has priority will become the common setting for the parts. During Song playback, setting for a Song part is used (priority order: Ch. 1, Ch. 2...Ch. 16), while the setting for a keyboard part is used when Song playback is stopped (priority order: R1, L and R2 Voices).	Differs depending on the Voice or Voice combination.	0 – 40	
		Chorus Depth (page 27)	Adjusts the Chorus depth for each of the R1/R2/L Voices. This lets you adjust the balance between the R1/R2/L Voices when Dual/Split/Duo is on. The "0" setting will produce no effect.  <b>NOTE</b> When a VRM Voice is used for several parts simultaneously, unexpected sounds may result since the Chorus depth for a part which has priority will become the common setting for the parts. During Song playback, setting for a Song part is used (priority order: Ch. 1, Ch. 2...Ch. 16), while the setting for a keyboard part is used when Song playback is stopped (priority order: R1, L and R2 Voices).	Differs depending on the Voice or Voice combination.	0 – 127	
		Effect	Refer to the description of "Effect" on page 28.			
		Rotary Speed	Available only for the Voice of which the Effect Type is set to "Rotary." This parameter determines the rotation speed of the Rotary Speaker effect.	Differs depending on the Voice or Voice combination.	Fast, Slow	
		VibeRotor	Available only for the Voice of which the Effect Type is set to "VibeRotor." This parameter turns on or off the VibeRotor effect.	Differs depending on the Voice or Voice combination.	On, Off	
		VibeRotor Speed	Available only for the Voice of which the Effect Type is set to "VibeRotor." This parameter determines the speed of the Vibraphone vibrato effect.	Differs depending on the Voice or Voice combination.	1 – 10	
		Effect Depth	Adjusts the Effect depth for each of the R1/R2/L Voices. Note that some Effect types do not allow you to adjust the depth.	Differs depending on the Voice or Voice combination.	1 – 127	
		Pan	Adjusts the stereo pan position for each of the selected R1/R2/L Voices.	Differs depending on the Voice or Voice combination.	L64 (leftmost) – C (center) – R63 (rightmost)	
		Harmonic Cont	Produces a distinctive "peaky" tone by raising the Resonance value of the Filter. This parameter can be set for each of the selected R1/R2/L Voices when Dual/Split/Duo is on.  <b>NOTE</b> Harmonic content may have little audible effect or not be applied to some Voices.	Differs depending on the Voice or Voice combination.	-64 – +63	
Brightness	Adjusts the brightness of the selected R1/R2/L Voices independently.	Differs depending on the Voice or Voice combination.	-64 – +63			



<b>To call up the desired parameter:</b>					
Turn on Dual, Split or Duo as necessary, select Voices as necessary, press the [MENU] button several times to select "Voice" menu, then use the [▲]/[▼]/[◀]/[▶] buttons to select the desired parameter.					
[▶] [◀]	[▶] [◀]	[▶] [◀]	Description	Default setting	Setting range
Voice Edit	(Voice names)*	Touch Sens.	Determines the degree to which the volume level changes in response to your touch on the keyboard (how hard you play). Since the volume level of some Voices such as Harpsichord and Organ do not change regardless of how you play the keyboard, the default setting for these Voices is 127.	Differs depending on the Voice or Voice combination.	0 (softest) – 64 (largest changes in the level) – 127 (which produces the loudest volume regardless of how you play the keyboard)
		RPedal	Turns the Right pedal function on or off for each of the selected R1/R2/L Voices. This parameter is useful when you want to ensure, for example, that the pedal function affects the Right section but does not affect the Left section.	Differs depending on the Voice or Voice combination.	On, Off
		CPedal	Turns the Center pedal function on or off for each of the selected R1/R2/L Voices. This parameter is useful when you want to ensure, for example, that the pedal function affects the Right section but does not affect the Left section.	Differs depending on the Voice or Voice combination.	On, Off
		LPedal	Turns the Left pedal function on or off for each of the selected R1/R2/L Voices. This parameter is useful when you want to ensure, for example, that the pedal function affects the Right section but does not affect the Left section.	Differs depending on the Voice or Voice combination.	On, Off
Pedal Assign (When using the separately sold pedal unit, page 15)	Right	(Setting display)	Assigns one of various functions (other than the original one) to the Right pedal.	Sustain (Cont.)	Refer to the Pedal Function List (page 17).
	Center	(Setting display)	Assigns one of various functions (other than the original one) to the Center pedal.	Sostenuto	Refer to the Pedal Function List (page 17).
	Left	(Setting display)	Assigns one of various functions (other than the original one) to the Left pedal.	Rotary Speed (Jazz Organ, Rock Organ), VibeRotor (Vibraphone), Soft (other Voices)	Refer to the Pedal Function List (page 17).
Balance*	Volume R2 – R1*	(Pop-up window)	Adjusts the volume balance between R1 and R2 Voices when Dual is on. After adjusting this with the [◀]/[▶] buttons, press the [EXIT] button to exit from the pop-up window.	Differs depending on the Voice or Voice combination.	R2+10 – 0 – R1+10
	Volume L – R*	(Pop-up window)	Adjusts the volume balance between the right and left sections when Split/Duo is on. After adjusting via the [◀]/[▶] buttons, press the [EXIT] button to exit from the pop-up window.	Differs depending on the Voice or Voice combination.	L+10 – 0 – R+10
	Detune*	(Pop-up window)	Detunes the R1 Voice and R2 Voice in Dual mode to create a thicker sound. On the display, move the slider rightward via the [▶] button will raise the R1 Voice pitch and lower the R2 Voice pitch, and vice versa. After adjusting this, press the [EXIT] button to exit from the pop-up window.	Differs depending on the Voice or Voice combination.	R2+20 – 0 – R1+20



## Song Menu

This menu lets you set various parameters related to Song playback and edit the Song data. Select a desired Song before beginning the operation.

### NOTE

- The parameters marked with \* will be available only when a MIDI Song is selected. These parameters are not shown when an Audio Song is selected.
- The parameters marked with \*\* will be available only when an Audio Song is selected.
- When using the "Edit" menu, select a MIDI Song other than the preset Song.
- Execute is a function that edits or changes the current Song data. Note that pressing the [▶] button will actually change the Song data.
- The content of the "Song" menu differs depending on the type of Song currently selected (MIDI/Audio).

<b>To call up the desired parameter:</b> Press the [MENU] button several times to select "Song" menu, then use the [▲]/[▼]/[◀]/[▶] buttons to select the desired parameter.					
[▶] [◀]	[▶] [◀]	[▶] [◀]	Description	Default setting	Setting range
L/R* (page 48)	R, L, Extra	–	Turns on (Play) or off (Mute) each of the Song tracks.	On	On, Off
Repeat (page 49)	A – B*	(Setting display)	Lets you play back a specified range (from Point A to B) of the current Song repeatedly.	Off	On, Off
	Phrase*	Phrase Mark	This parameter is available only when a MIDI Song containing the Phrase Mark. By specifying a Phrase number here, you can play back the current Song from the mark point, or to play back the corresponding phrase repeatedly. If you start Song playback with a Phrase set to "On," the countdown starts, followed by repeated playback of the specified phrase or phrases until you press the [PLAY/PAUSE] button.	000	000 – the last phrase number of the Song
		Repeat		Off	On (repeat playback)/Off (no repeat)
Song	(Setting display)	By setting this parameter, you can play back only a specific Song, or specific Songs in order repeatedly or randomly.	Off	Off, Single, All, Random	
Volume (page 52)	Song – Keyboard*	(Pop-up window)	Adjusts the volume balance between the Song playback sound and keyboard performance.	0	Song+64 – 0 – Key+64
	Song L – R*	(Pop-up window)	Adjusts the volume balance between the right-hand part left-hand parts of Song playback.	0	L+64 – 0 – R+64
	(Pop-up window)**		Adjusts the Audio volume.	100	0 – 127
Transpose (page 53)	(Setting display)	–	Shifts the pitch of Song playback up or down in semitone intervals. For example, if you set this parameter to "5," a Song created in C major will be played back in F major.  <b>NOTE</b> <ul style="list-style-type: none"> <li>• The Transpose setting will not affect the audio signals, such as those input from the [AUX IN] jack.</li> <li>• MIDI Song playback data will be transmitted with the transposed note numbers while MIDI note numbers received from an external MIDI device or computer will not be affected by the Transpose setting.</li> <li>• Applying transpose to an Audio Song may change its tonal characteristics.</li> </ul>	0	-12 (-1 octave) – 0 (normal pitch) – +12 (+1 octave)
File	Delete (page 68)	Cancel	Deletes a specific Song. For details about Song types which can be deleted, refer to page 66.	–	–
		Execute		–	–
	Copy* (page 68)	Cancel	Copies a specific MIDI Song then saves it to a different location. For details about Song types which can be copied, refer to page 66.	–	–
		Execute		–	–

<b>To call up the desired parameter:</b> Press the [MENU] button several times to select "Song" menu, then use the [▲]/[▼]/[◀]/[▶] buttons to select the desired parameter.					
[▶] [◀]	[▶] [◀]	[▶] [◀]	Description	Default setting	Setting range
File	Move* (page 69)	Cancel	Moves a MIDI Song to a different location. For details about Song types which can be moved, refer to page 66.	–	–
		Execute		–	–
	MIDI to Audio* (page 70)	Cancel	Converts a MIDI Song to an Audio file. For details about Song types which can be converted, refer to page 66.	–	–
		Execute		–	–
	Rename (page 71)	(Setting display)	Edits a Song name. For details about Song types which can be renamed, refer to page 66.	–	–
	Edit*	Quantize	Quantize	The Quantize function allows you to align all the notes in the current MIDI Song to the correct timing, such as 8th note or 16th note.	1/16
Strength			1. Set the Quantize value to the smallest notes in the MIDI Song. 2. Set the Strength value which determines how strongly the notes will be quantized. 3. Move the highlight to "Execute" then press the [▶] button to actually change the MIDI Song data.	100%	0% – 100% Refer to "Strength setting range." (page 100)
Execute				–	–
Track Delete		Track	Deletes a specific track data of the current MIDI Song. 1. Select the desired track to be deleted.	Track 1	Track 1 – Track 16
		Execute	2. Move the highlight to "Execute," then press the [▶] button to actually delete the specified track data.	–	–
Tempo Change		Cancel	Changes the tempo value of the current MIDI Song as data. Before calling up the "Song" menu display, set the desired Tempo value for changing.	Differs depending on the Song	–
		Execute	Move the highlight to "Execute," then press the [▶] button to actually change the Tempo value as MIDI Song data.	–	–
Voice Change		Track	Changes the Voice of a specific track in the current MIDI Song to the current Voice as data. 1. Select a track of which the Voice will be changed.	Track 1	Track 1 – Track 16
		Execute	2. Move the highlight to "Execute," then press the [▶] button to actually change the Voice as MIDI Song data.	–	–
Others*		Quick Play	–	This parameter enables you to specify whether a Song that starts from the middle of a bar, or a Song with a silence prior to the first note, should be played from the first note or from the top of the bar (rest or blank). This parameter is useful for a MIDI Song that starts with a short one-or two-beat pick-up or lead-in.	On
	Track Listen	Track	This lets you play back only the selected Track to listen to its contents. To do this, select a Track, move the highlight to "Start," then press and hold the [▶] button to start playback from the first note. Playback continues while holding the [▶] button.	Track 1	Track 1 – Track 16
		Start			
Play Track	–	This parameter enables you to specify the tracks for playing back on this instrument. When "1&2" is selected, only tracks 1 and 2 will be played back, while tracks 3 to 16 will be transmitted via MIDI. When "All" is selected, all tracks will be played back on this instrument.	All	All, 1&2	

**NOTE**

Tempo of Song playback can be set on the display called up by pressing the [TEMPO] button. For instructions, refer to page 47.

## ■ Quantize Supplementary

### Quantize setting range

---

- 1/4..... ♩ quarter note
- 1/6..... ♩<sub>3</sub> quarter note triplet
- 1/8..... ♪ eighth note
- 1/12..... ♪<sub>3</sub> eighth note triplet
- 1/16..... ♪ sixteenth note
- 1/24..... ♪<sub>3</sub> sixteenth note triplet
- 1/32..... ♪ thirty-second note
- 1/8+1/12..... ♪+♪<sub>3</sub> eighth note + eighth note triplet\*
- 1/16+1/12..... ♪+♪<sub>3</sub> sixteenth note + eighth note triplet\*
- 1/16+1/24..... ♪+♪<sub>3</sub> sixteenth note + sixteenth triplet\*

The three Quantize settings marked with asterisks (\*) are exceptionally convenient, since they allow you to quantize two different note values at the same time. For example, when the straight eighth notes and eighth notes triplet are contained in the same part, if you quantize by straight eighth notes, all notes in the part are quantized to straight eighth notes—completely eliminating any triplet feel. However, if you use the eighth note + eighth note triplet setting, both the straight and triplet notes will be quantized correctly.

### Strength setting range

---

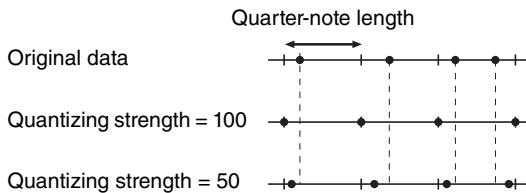



## Metronome/Rhythm Menu

This menu lets you set the volume and tempo indication format of the Metronome (page 41) or Rhythm (page 43). In addition, you can set the bell sound of the Metronome to play back at the first beat and adjust parameters related to Rhythm playback variation.







**To call up the desired parameter:**

Press the [MENU] button several times to select "Metronome/Rhythm" menu, then use the [▲]/[▼] buttons to select the desired parameter.

[▶] [◀]	[▶] [◀]	[▶] [◀]	Description	Default setting	Setting range
Time Sig. (Time Signature)	(Setting display)	–	Determines the time signature of the metronome. When you select or playback MIDI Songs, this will automatically be changed to the time signature of the selected songs.	4/4	2/2, 3/2, 1/4, 2/4, 3/4, 4/4, 5/4, 6/4, 7/4, 3/8, 6/8, 7/8, 9/8, 12/8
Volume	(Pop-up window)	–	Determines the volume of the Metronome or Rhythm. You can adjust the volume balance between the keyboard performance and Metronome/Rhythm playback.	82	0 – 127
BPM	–	–	Determines whether the note type of the tempo indication is affected by the Metronome Time Signature (page 42) or not (crotchet). When "Time Sig." is selected, the denominator of the Time Signature is shown as the note type of the tempo indication. (The dotted quarter note is shown as the note type of the tempo indication only when the Time Signature is set to "6/8," "9/8," or "12/8.")	Time Sig.	Time Sig., Crotchet
Bell	–	–	Determines whether or not the bell sound is played back at the first beat of the specified Time Signature.	Off	On, Off
Intro	–	–	Determines whether the Intro is played back or not before the Rhythm pattern is started. <b>NOTE</b> During Song playback, the Intro cannot be played back even if you start the Rhythm with this parameter set to "On."	On	On, Off
Ending	–	–	Determines whether the Ending is played back or not before the Rhythm pattern is stopped.	On	On, Off
SyncStart	–	–	When this is set to "On," you can start Rhythm playback also by pressing any note on the keyboard.  When you want to use this function, follow the instructions below: 1. Set this function to on. 2. Press the [RHYTHM] button to enter the Synchro start standby mode. The [RHYTHM] button flashes. 3. Press any key to start with the rhythm.	Off	On, Off
Bass	–	–	Determines whether the auto bass accompaniment for the Rhythm is on or off.	On	On, Off

## Recording Menu

This menu lets you make detailed settings related to MIDI Recording (page 54). The settings here will not affect Audio Recording.

<b>To call up the desired parameter:</b> Press the [MENU] button several times to select "Recording" menu, then use the [▲]/[▼] buttons to select the desired parameter.					
 	 	 	<b>Description</b>	<b>Default setting</b>	<b>Setting range</b>
RecStart	–	–	This parameter, which is used when you overwrite the already recorded MIDI Song, determines when the actual MIDI Recording starts after you execute the Recording Start operation. For details, refer to page 62.	Normal	Normal, KeyOn
RecEnd	–	–	This parameter, which is used when you overwrite the already recorded MIDI Song, determines whether the existing data after the point at which you stop recording will be erased or not. For details, refer to page 62.	Replace	Replace, PunchOut
RecRhythm	–	–	Determines whether or not Rhythm playback will be recorded during MIDI Recording.	On	On, Off

## / System Menu

This menu lets you make the overall settings applied to the entire instrument.



Bluetooth compatibility is indicated by the following icons. (For details on Bluetooth compatibility, see page 80.)

 : models equipped with Bluetooth

 : models not equipped with Bluetooth

### NOTE

Parameters marked with \* are available only if the instrument is equipped with Bluetooth functionality.

<b>To call up the desired parameter:</b> Press the [MENU] button several times to select "System" menu, then use the [▲]/[▼]/[◀]/[▶] buttons to select the desired parameter.					
 [▶] [◀]	 [▶] [◀]	 [▶] [◀]	Description	Default setting	Setting range
Bluetooth* (pages 79 – 80)	Bluetooth	(Setting display)	Switches the Bluetooth function on/off (page 80).	On	On, Off
	Pairing	(Setting display)	For registering (pairing) the Bluetooth-equipped device (page 79). This parameter is shown only when "Bluetooth" (above) is set to "On."	–	–
Tuning	Master Tune (page 35)	(Pop-up window)	Fine tunes the pitch of the entire instrument.	A3 = 440.0 Hz	A3 = 414.8 Hz – 466.8 Hz (approx. 0.2 Hz steps)
	Scale Tune	(Setting display)	Modern acoustic pianos are tuned almost exclusively in equal temperament, which divides one octave into twelve equal intervals. Likewise, this digital piano employs equal temperament, but it can be changed at the touch of a button to play in historical temperaments used in the 16th to 19th centuries.	Equal	Refer to the "Scale Tune List" below.
	Base Note	(Setting display)	Determines the base note for the Scale selected above. When the base note is changed, the pitch of the keyboard is transposed, yet maintains the original pitch relationship between the notes. This setting is necessary when Scale Tune is set to something other than "Equal."  <b>NOTE</b> When Scale Tune is set to "Equal," "–" is shown on the display and this parameter cannot be edited.	C	C, C#, D, Eb, E, F, F#, G, Ab, A, Bb, B

## ■ Scale Tune List (Temperament List)

Equal (Temperament)	One octave is divided into twelve equal intervals. Currently most popular piano tuning scale.
PureMajor/PureMinor	Based on natural overtones, three major chords using these scales produce a beautiful, pure sound.
Pythagorean	This scale was devised by Pythagoras, the famous Greek philosopher and is created from a series of perfect fifths, which are collapsed into a single octave. The 3rd in this tuning is slightly unstable, but the 4th and 5th are beautiful and suitable for some leads.
MeanTone	This scale was created as an improvement on the Pythagorean scale, by making the major third interval more "in tune." It was especially popular from the 16th century to the 18th century. Handel, among others, used this scale.
Werckmeister/ Kirnberger	These scales combine Mean Tone and Pythagorean in different ways. With these scales, modulation changes the impression and feel of the Songs. They were often used in the era of Bach and Beethoven. They are also often used now to reproduce the music of that era on harpsichords.

<b>To call up the desired parameter:</b> Press the [MENU] button several times to select System menu, then use the [▲]/[▼]/[◀]/[▶] buttons to select the desired parameter.					
[▶] [◀]	[▶] [◀]	[▶] [◀]	Description	Default setting	Setting range
Keyboard	Touch (page 36)	(Setting display)	Determines how the sound responds to your playing strength. This setting does not change the weight of the keyboard.	Medium	Soft 2, Soft 1, Medium, Hard 1, Hard 2, Fixed
	Fixed Velocity	(Pop-up window)	Determines the velocity with which you play the keys when Touch (above) is set to "Fixed."  <b>NOTE</b> The setting here will not be recorded to a MIDI Song and not be transmitted as MIDI messages.	64	1 – 127
	Duo (page 32)	(Setting display)	Splits the keyboard into two ranges, allowing you to play duets over the same octave range.	Off	On, Off
	Duo - Type	–	Selects the sound balance between the left and right speakers while Duo is on. <ul style="list-style-type: none"> <li>• <b>Separated:</b> The sound played by the left player is output from the left speaker(s), and the sound played by the right player is output from the right speaker(s).</li> <li>• <b>Balanced:</b> The sounds played by the right and left players are output through both speakers, with a natural balance of sound.</li> </ul>	Separated	Separated, Balanced
	Split Point (page 30)	(Setting display)	Determines the Split Point (the boundary between the right-hand and left-hand keyboard areas).	F#2 (Split), E3 (Duo)	A-1 – C7
Pedal	Half Pedal Point (page 15)	(Pop-up window)	Here you can specify the point to which you must depress the right pedal or a pedal connected to the [AUX PEDAL] jack before the assigned effect begins to be applied. This setting applies only to the "Sustain (Continuous)" effect (page 17) that is assigned to the right or AUX pedal.	0	-2 (effective with the shallowest press) – 0 – +4 (effective with the deepest press)
	Soft Pedal Depth	(Pop-up window)	Determines how deeply the Soft pedal effect is applied. This parameter is available only for the pedal to which "Soft" (page 17) is assigned.	5	1 – 10
	Pitch Bend Range	(Pop-up window)	Determines the range of the pitch bend that is produced via the pedal in semitone steps. This setting is available only for the pedal to which "PitchBend Up" or "PitchBend Down" (page 17) is assigned.  <b>NOTE</b> For some Voices, the pitch may not be changed according to the Pitch Bend Range value set here.	2	0 – +12 (pressing the pedal will raise/lower the pitch by 12 semitones [1 octave])
	Aux Polarity (page 15)	–	A pedal connected to the [AUX PEDAL] jack may switch on and off differently. For example, some pedals turn the effects on and others turn them off when you press them. Use this parameter to reverse this mechanism.	Make	Make, Break
	Aux Assign	(Setting display)	Assigns a function to the pedal connected to the [AUX PEDAL] jack.	Sustain (Continuous)	Refer to the Pedal Function List (page 17).
	Aux Area	(Setting display)	Determines the keyboard area to which the function of the pedal connected to the [AUX PEDAL] jack is applied.	All	All, Right, Left
	Play/Pause	(Setting display)	Assigns the [PLAY/PAUSE] button's function to one of the Left pedal, Center pedal and pedal connected to the [AUX PEDAL] jack. If a value other than "Off" is selected here, the corresponding pedal's function assigned in the "Voice" menu (page 97) is disabled.	Off	Off, Left, Center, AUX





To call up the desired parameter: Press the [MENU] button several times to select System menu, then use the [▲]/[▼]/[◀]/[▶] buttons to select the desired parameter.					
[▶] [◀]	[▶] [◀]	[▶] [◀]	Description	Default setting	Setting range
Sound	IAC (page 13)	–	Turns the IAC effect on or off.	On	On, Off
	IAC depth	(Pop-up window)	Determines the depth of the IAC. The higher the value, the more clearly the low/high sounds at lower volume levels.	0	-3 – +3
	Binaural (page 14)	–	Turns the Binaural Sampling function (when headphones are connected) on or off. When the function is on and headphones are connected, the sound from this instrument changes to the sound of Binaural Sampling or the sound enhanced with the Stereophonic Optimizer, allowing you to enjoy more realistic sound.  <b>NOTE</b> When the "Speaker" setting (page 106) is on, this function will always be disabled even when headphones are connected.	On	On, Off
MIDI	MIDI OUT	(Setting display)	Determines the MIDI channel on which the MIDI messages generated via the keyboard performance will be transmitted from the MIDI [OUT] or [USB TO HOST] terminal. When Dual/Split/Duo is on, the MIDI channels are assigned as follows. <ul style="list-style-type: none"> <li>• Performance via the R1 Voice = n (setting value)</li> <li>• Performance via the R2 Voice = n+2</li> <li>• Performance via the L Voice = n+1</li> </ul>	Ch1	Ch1 – Ch16, Off (not transmitted)
	MIDI IN	(Setting display)	Determines which part of the instrument will be controlled by each channel data of the MIDI messages coming from the MIDI [IN] and [USB TO HOST] terminal. <ul style="list-style-type: none"> <li>• <b>Song:</b> Song part is controlled by the MIDI messages.</li> <li>• <b>Keyboard:</b> The entire keyboard is controlled regardless of the Dual/Split/Duo setting.</li> <li>• <b>R1:</b> The keyboard performance via the R1 Voice is controlled.</li> <li>• <b>R2:</b> The keyboard performance via the R2 Voice is controlled.</li> <li>• <b>L:</b> The keyboard performance via the L Voice is controlled.</li> <li>• <b>Off:</b> No part is controlled.</li> </ul>	"Song" for each of all MIDI channels	For each MIDI channel: <ul style="list-style-type: none"> <li>• Song</li> <li>• Keyboard</li> <li>• R1</li> <li>• R2</li> <li>• L</li> <li>• Off</li> </ul>
	Local Control	–	"Local Control On" is a state in which this instrument produces the sound from its tone generator when you play the keyboard. In "Local Control Off" state, the keyboard and the tone generator are cut off from each other. This means that even if you play the keyboard, this instrument will produce no sound. Instead, the keyboard data can be transmitted via MIDI to a connected MIDI device or computer, which can produce the sound. The "Local Control Off" setting is useful when you wish to play only an external sound source while playing the keys on this instrument.	On	On, Off
	Receive Param.	(Setting display)	Determines which types of MIDI messages can be received or recognized by this instrument.  <b>MIDI message types:</b> Note on/off, Control Change, Program Change, Pitch Bend, System Exclusive	On (for all the MIDI messages)	On, Off (for each MIDI message)
	Transmit Param.	(Setting display)	Determines which types of MIDI messages can be transmitted from this instrument.  <b>MIDI message types:</b> Note on/off, Control Change, Program Change, Pitch Bend, SystemRealTime, System Exclusive	On (for all the messages)	On, Off (for each message)

<b>To call up the desired parameter:</b> Press the [MENU] button several times to select System menu, then use the [▲]/[▼]/[◀]/[▶] buttons to select the desired parameter.					
[▶] [◀]	[▶] [◀]	[▶] [◀]	Description	Default setting	Setting range
MIDI	Initial Setup	Cancel	Transmits the current panel settings such as Voice selection to a connected MIDI device or computer. Before you start recording your performance to a connected MIDI device or computer, execute this operation to record the current panel settings at the beginning of your performance data. It causes that the same panel settings are called up when the recorded performance is played back.  <b>Operation:</b> Move the highlight to "Execute," then press the [▶] button to transmit the panel settings as MIDI messages.	-	-
		Execute			
Backup	Backup Setting	-	For instructions about these functions, refer to pages 90 – 91.	-	-
	Backup	-			
	Restore	-			
	Factory Reset	-			
Utility	Speaker	(Setting display)	Lets you switch the speaker on/off. • <b>Normal</b> The speaker will sound only if headphones are not connected. • <b>On</b> The speaker will always sound. • <b>Off</b> The speaker will not sound.  <b>NOTE</b> When this setting is on, "Binaural" (page 14) will always be disabled.	Normal	Normal, On, Off
	Audio Loopback (page 78)	-	Determines whether audio input from the connected computer or smart device is output to a computer or a smart device or not.	Off	On, Off
	Auto Power Off (page 13)	(Setting display)	Lets you set the amount of time that elapses before the power is turned off by Auto Power Off function. To disable Auto Power Off, select "Off."	30 (minutes)	Off, 5, 10, 15, 30, 60, 120 (minutes)
	USB Properties	-	Shows the amount of free space and entire memory in the USB flash drive connected to the [🔌] (USB TO DEVICE) terminal.  	-	-
	USB Autoload	-	When this is set to "On," the Song saved in the root directory can be selected automatically as soon as the USB flash drive is connected to the [🔌] (USB TO DEVICE) terminal.	Off	On, Off

**To call up the desired parameter:**

Press the [MENU] button several times to select System menu, then use the [▲]/[▼]/[◀]/[▶] buttons to select the desired parameter.

[▶] [◀]	[▶] [◀]	[▶] [◀]	Description	Default setting	Setting range																																																																																																
Utility	USB Format	Cancel	This lets you format or initialize the USB flash drive connected to the [  ] (USB TO DEVICE) terminal.  <b>NOTICE</b> Executing the Format operation will delete all data saved in the USB flash drive. Save important data to a computer or another storage device.  <b>NOTE</b> When connecting the USB flash drive to the [  ] (USB TO DEVICE) terminal, a message prompting you to execute the Format operation may appear. If such a case occurs, execute the Format operation.  <b>Operation</b> Move the highlight to "Execute," then press the [▶] button to start the Format operation. After Formatting is completed, a message appears then the instrument returns to the Utility display after a while.  <b>NOTICE</b> Never turn off the power or disconnect the USB flash drive while "Executing" is shown in the display.	–	–																																																																																																
		Execute																																																																																																			
	Contrast	(Pop-up window)	Adjusts the contrast of the display.	0	-5 – +5																																																																																																
	Language	System	Determines the type of characters shown on the display for the System (general indication other than Song name) and Song (Song name) individually.  <b>Character list</b> International <table border="1" data-bbox="510 975 926 1078"> <tr><td>0~9</td><td>A~Z</td><td>a~z</td><td>Ä</td><td>Ë</td><td>Ï</td><td>Ö</td><td>Ü</td><td>ä</td><td>ë</td><td>ï</td><td>ö</td><td>ü</td><td>à</td><td>è</td><td>ì</td><td>ò</td></tr> <tr><td>ù</td><td>á</td><td>é</td><td>í</td><td>ó</td><td>ú</td><td>â</td><td>ê</td><td>î</td><td>ô</td><td>û</td><td>ñ</td><td>ñ</td><td>Ç</td><td>ç</td><td>°</td><td>;</td><td>!</td><td>#</td><td>\$</td></tr> <tr><td>%</td><td>&amp;</td><td>'</td><td>(</td><td>)</td><td>+</td><td>,</td><td>-</td><td>;</td><td>=</td><td>@</td><td>[</td><td>]</td><td>^</td><td>~</td><td>{</td><td>}</td><td>~</td><td>.</td><td> </td></tr> </table> Japanese <table border="1" data-bbox="510 1110 916 1213"> <tr><td>0~9</td><td>A~Z</td><td>a~z</td><td>ア~ン</td><td>ア~オ</td><td>ヤ</td><td>ユ</td><td>ヨ</td><td>ツ</td><td>°</td><td>。</td><td>ー</td></tr> <tr><td>「</td><td>」</td><td>、</td><td>・</td><td>！</td><td>＃</td><td>＄</td><td>％</td><td>&amp;</td><td>'</td><td>(</td><td>)</td><td>+</td><td>,</td><td>-</td><td>;</td><td>=</td><td>@</td><td>[</td><td>]</td><td>^</td><td>~</td><td>{</td><td>}</td><td>~</td><td>.</td><td> </td></tr> </table>	0~9	A~Z	a~z	Ä	Ë	Ï	Ö	Ü	ä	ë	ï	ö	ü	à	è	ì	ò	ù	á	é	í	ó	ú	â	ê	î	ô	û	ñ	ñ	Ç	ç	°	;	!	#	\$	%	&	'	(	)	+	,	-	;	=	@	[	]	^	~	{	}	~	.		0~9	A~Z	a~z	ア~ン	ア~オ	ヤ	ユ	ヨ	ツ	°	。	ー	「	」	、	・	！	＃	＄	％	&	'	(	)	+	,	-	;	=	@	[	]	^	~	{	}	~	.		International	Japanese, International
		0~9	A~Z	a~z	Ä	Ë	Ï	Ö	Ü	ä	ë	ï	ö	ü	à	è	ì	ò																																																																																			
ù	á	é	í	ó	ú	â	ê	î	ô	û	ñ	ñ	Ç	ç	°	;	!	#	\$																																																																																		
%	&	'	(	)	+	,	-	;	=	@	[	]	^	~	{	}	~	.																																																																																			
0~9	A~Z	a~z	ア~ン	ア~オ	ヤ	ユ	ヨ	ツ	°	。	ー																																																																																										
「	」	、	・	！	＃	＄	％	&	'	(	)	+	,	-	;	=	@	[	]	^	~	{	}	~	.																																																																												
Song																																																																																																					
Version	–	–	Displays the model name and the firmware version of this instrument.	–	–																																																																																																
Wireless LAN			These parameters are shown only when the USB wireless LAN adaptor UD-WL01 (sold separately) is connected to the [  ] (USB TO DEVICE) terminal on this instrument. For details, refer to page 108.																																																																																																		
Wireless LAN Option																																																																																																					

## Wireless LAN Settings

The following parameters are shown only when the USB wireless LAN adaptor UD-WL01 (sold separately) is connected to the [↔] (USB TO DEVICE) terminal on this instrument.

\* "Wireless LAN" parameters differ depending on the "Wireless LAN Mode" setting ("Infrastructure" or "Accesspoint"). By default, it is set to "Infrastructure."

To call up the desired parameter: Press the [MENU] button several times to select "System" menu, then use the [▲]/[▼]/[◀]/[▶] buttons to select the desired parameter.							
[▶] [◀]	[▶] [◀]	[▶] [◀]	[▶] [◀]	[▶] [◀]	Description	Default setting	Setting range
Utility	Wireless LAN* (In the "Infrastructure" mode)	Select Network	(Networks)		Connects to an access point by selecting the network.	–	–
			Other	SSID	Sets the SSID.	–	Up to 32 characters (half size), alphanumeric characters, marks
				Security	Sets the Security.	NONE	NONE, WEP, WPA-PSK (TKIP), WPA-PSK (AES), WPA2-PSK (AES), WPA/WPA2 mixed PSK
				Password	Sets the Password.	–	Up to 64 characters (half size), alphanumeric characters, marks
				Connect	Connects using the settings in "Other" display.	–	–
		Detail	DHCP		Sets the wireless LAN detailed settings. IP Address, Subnet Mask, Gateway, DNS Server1, DNS Server2 can be set when DHCP is set to Off while cannot be set when DHCP set to On. Use the [◀]/[▶] buttons to select each octet in the entry display, then enter the value using the [▲]/[▼] buttons. To finalize the setting, press the [MENU] button.	On	On/Off
			IP Address			0.0.0.0	0.0.0.0-255.255.255.255
			Subnet Mask			0.0.0.0	0.0.0.0-255.255.255.255
			Gateway			0.0.0.0	0.0.0.0-255.255.255.255
			DNS Server1			0.0.0.0	0.0.0.0-255.255.255.255
	DNS Server2			0.0.0.0	0.0.0.0-255.255.255.255		
	Save		Saves the settings in the "Detail" display. Move the highlight to "Save," then press the [▶] button to execute the Saving.	–	–		
	Wireless LAN* (In the "Accesspoint" mode)	SSID		Sets the SSID as an access point.	ap-[P-525]-[xxxxxx (MAC address lower 6 figure)]	Up to 32 characters (half size), alphanumeric characters, marks	
		Security		Sets the Security as an access point.	WPA2-PSK (AES)	NONE, WEP, WPA-PSK (TKIP), WPA-PSK (AES), WPA2-PSK (AES), WPA/WPA2 mixed PSK	
		Password		Sets the Password as an access point.	00000000	Up to 64 characters (half size), alphanumeric characters, marks	

<b>To call up the desired parameter:</b> Press the [MENU] button several times to select "System" menu, then use the [▲]/[▼]/[◀]/[▶] buttons to select the desired parameter.							
[▶] [◀]	[▶] [◀]	[▶] [◀]	[▶] [◀]	[▶] [◀]	Description	Default setting	Setting range
Utility	Wireless LAN* (In the "Accesspoint" mode)	Channel			Sets the channel as an access point.	11	Differs depending on the USB wireless LAN adaptor models. <ul style="list-style-type: none"> <li>• Models for United States and Canada: 1-11</li> <li>• Others: 1-13</li> </ul> When no USB wireless LAN adaptor is connected, setting range is channels 1-13.
		DHCP Server			Sets the IP address related settings.	On	On, Off
		IP Address				192.168.0.1	192.168.0-255.1-254.
		Subnet Mask				255.255.255.0	255.255.0.0, 255.255.128.0, 255.255.192.0, 255.255.224.0, 255.255.240.0, 255.255.248.0, 255.255.252.0, 255.255.254.0, 255.255.255.0
		Save			Saves the settings you set in the "Wireless LAN" display (in the "Accesspoint" mode)	-	-
Wireless LAN Option	Wireless LAN Mode	Infrastructure Mode		Determines whether the access point is used for wireless LAN connection (Infrastructure Mode) or not (Accesspoint Mode).	Infrastructure Mode	-	
		Accesspoint Mode					
	Initialize	Cancel		Initializes the settings in the "Wireless LAN" display. Move the highlight to "Execute," then press the [▶] button to execute the initialization.	Cancel	-	
		Execute					
	Detail	Host Name			Sets the Host name.	[P-525]-[xxxxxx (MAC address lower 6 figure)]	Up to 57 characters (half size) including alphanumeric characters, the "_" (underscore) and "-" (hyphen) character.
		Mac Address			Displays the MAC address of the USB wireless LAN adaptor.	-	-
		Status			Displays the error code of network function.	-	-

# Appendix

## Preset Voice List

Voice Group	Voice Name	Stereo Sampling	Touch Sense	Key-off Sampling	VRM	Voice Demo	Voice description
Piano	CFX Grand (Binaural included)	○	○	○	○	○	(CFX) Yamaha's CFX concert grand piano sound with a wide dynamic range for maximum expressive control. Suitable for playing in any music genre and style.  (Binaural) Yamaha's CFX concert grand piano sound sampled by Binaural Sampling, the method optimized for headphone use. Listening this through headphones gives the impression of being immersed in the sound, as if it was actually emanating from the piano. This Voice is selected automatically when headphones are connected.
	Bösendorfer	○	○	○	○	● <sup>(1)</sup>	The famed sound of the Vienna-made Bösendorfer Imperial concert grand piano. Its spacious sound evokes the size of the instrument, and is ideal for expressing tenderness in compositions.
	Studio Grand	○	○	○	○	○	The sound of Yamaha's C7 grand piano, which is often used in recording studios. Its bright and clear sound is good for popular styles.
	Bright Grand	○	○	○	○	—	Bright piano sound. Good for clear expression and "cutting through" other instruments in an ensemble.
	Ballad Grand	○	○	○	○	—	Grand piano sound with a soft and warm tone. Good for playing ballads.
	Warm Grand	○	○	—	○	—	Warm and soft piano sound. Good for relaxing music.
	Pop Grand	○	○	○	○	—	A slightly brighter piano sound. Good for popular styles.
	Jazz Grand	○	○	—	○	—	A piano sound with unique tonal character. Good for jazz styles.
	Rock Grand	○	○	○	○	—	A bright-sounding piano. Ideal for rock styles.
	Dance Grand	○	○	○	○	—	A brighter piano sound commonly used in dance music.
	Old School Pf	○	○	○	○	—	Compressed sound often used in popular music in the 1960s.
HonkyTonk Pf	○	○	—	○	—	A honky-tonk style piano. Enjoy a tonal character that is quite different than a grand piano.	
E.Piano	Stage E.Piano	—	○	○	—	○	The sound of an electric piano using hammer-struck metallic "tines." Soft tone when played lightly, and an aggressive tone when played hard.
	DX E.Piano	—	○	—	—	○	An electronic piano sound produced by an FM synthesizer. The tone will change as you vary your playing touch. Ideal for popular music.
	Vintage E.Piano	—	○	○	—	○	A different type of electric piano sound than Stage E.piano. Widely used in rock and popular music.
	Auto Pan EP	○	○	○	—	—	An electric piano sound with unique panning effect.
	Soft EP	—	○	○	—	—	Good for playing quiet ballads.
	Phaser EP	—	○	○	—	—	A distinctive phaser effect makes this ideal for fusion styles.
	Dyno E.Piano	○	○	○	—	—	An electric piano sound with unique attack characteristics, often heard in the 1980s.
	DX Bright	—	○	—	—	—	A variation of electronic piano sound produced by an FM synthesizer. Its bright and sparkling sound character spice up the music.
Tremolo Vintage	—	○	○	—	—	Includes tremolo ideal for Vintage EP. Frequently used in rock music.	
Organ	Jazz Organ 1	—	—	—	—	○	The sound of an electric organ often heard in jazz and rock idioms. A slightly brighter sound in which the Rotary effect is set to a slow speed. * Connecting the separately sold pedal unit (LP-1 or FC35) enables you to switch the speed of the Rotary effect between slow and fast by pressing the left pedal of the unit.
	Jazz Organ 2	—	—	—	—	—	The sound of an electric organ often heard in jazz and rock idioms. The Rotary effect is set to a fast speed. * Connecting the separately sold pedal unit (LP-1 or FC35) enables you to switch the speed of the Rotary effect between slow and fast by pressing the left pedal of the unit.
	Rock Organ	—	—	—	—	○	Bright and sharp electric organ sound. Optimum for rock music.
	Vintage Organ	—	—	—	—	—	The sound of transistor organs popular in the 1960s.
	Organ Principal	○	—	—	—	● <sup>(2)</sup>	This Voice features the combination of pipes (8'+4'+2') of a principal (brass instrument) organ. It is suitable for Baroque church music.
	Organ Tutti	○	—	—	—	○	This Voice features a full coupler of a pipe organ, famous for the sound used in Toccata and Fugue by Bach.

Voice Group	Voice Name	Stereo Sampling	Touch Sense	Key-off Sampling	VRM	Voice Demo	Voice description
CLV./VIB.	Harpichord 8'	○	—	○	—	● <sup>(3)</sup>	The sound of the instrument frequently used in baroque music. Variations in playing touch will not affect the volume, and a characteristic sound will be heard when you release the key.
	Harpsi.8'+4'	○	—	○	—	—	A harpsichord with an added upper octave. Produces a more brilliant sound.
	E.Clavichord	—	○	○	—	○	This is the voice of a keyboard that produces sound by striking strings and using magnetic pickups. This 'funky' sound is popular in soul and rhythm and blues music. Because of its unique mechanism, the instrument produces a peculiar sound when you release the keys.
	Vibraphone	○	○	—	—	○	A Vibraphone sound, sampled in stereo. Its spacious and clear sound is ideal for popular music.
Strings	Strings	○	○	—	—	○	Stereo-sampled, large-scale strings ensemble with realistic reverb. Try combining this Voice with piano in the Dual mode.
	Slow Strings	○	○	—	—	—	The sound of a string ensemble, with a slow attack. Suitable for use in Dual mode with piano or electric piano.
	Choir	—	○	—	—	○	A big, spacious choir Voice. Perfect for creating rich harmonies in slow pieces.
	Slow Choir	—	○	—	—	—	The sound of a choir with a slow attack. Suitable for use in Dual mode with piano or electric piano.
	Dark Pad	—	○	—	—	○	Warm and spacious synth sound. Ideal for sustained parts in the background of an ensemble, or for use in Dual mode with piano or electric piano.
	Lite Pad	—	○	—	—	—	Bright and spacious synth sound. Ideal for sustained parts in the background of an ensemble, or for use in Dual mode with piano or electric piano.
	Bell Pad	○	○	—	—	—	Synth sound with a crisp, bell-like sound. Ideal for layering in Dual mode with a piano or electric piano sound, but also produces a bright, gorgeous sound on its own.
Others	Acoustic Bass	—	○	—	—	○	The sound of a finger-plucked acoustic bass. Frequently used in jazz and Latin music.
	Electric Bass	—	○	—	—	○	The sound of an electric bass. Frequently used in jazz, rock, and popular music.
	Bass & Cymbal	—	○	—	—	—	The sound of a cymbal layered with acoustic bass. Effective when used for jazz walking-bass lines.
	Fretless Bass	—	○	—	—	○	The sound of a fretless bass. Suitable for styles such as jazz and fusion.
	Nylon Guitar	○	○	—	—	○	Stereo-sampled, nylon-string guitar with natural reality. Suitable for any style of musics.
	Steel Guitar	—	○	—	—	—	A bright steel-string guitar sound. Ideal for popular music.
XG	XG	—	○	—	—	○	For details on XG Voices, refer to the "XG Voice list" in the Data List on the website (page 6).

**VRM**

Simulated string resonance sound with physical modeling when the damper pedal is pressed or keys are pressed.

**Key-off Sampling**

Samples of the very delicate noises that are produced when keys are released.

**Voice Demo List**

	Voice Group	Voice Name	Title	Composer
● <sup>(1)</sup>	Piano	Bösendorfer	Mädchens Wunsch (6 Chants polonaise S.480 R.145)	F. Liszt / F. F. Chopin
● <sup>(2)</sup>	Organ	Organ Principal	Herr Christ, der ein'ge Gottes-Sohn, BWV 601	J. S. Bach
● <sup>(3)</sup>	CLV./VIB.	Harpichord 8'	Concerto a cembalo obbligato, 2 violini, viola e continuo No.7, BWV 1058	J. S. Bach

The Voice Demos with (●) listed above are short rearranged excerpts of the original compositions. All other Demo Songs are Yamaha original (© Yamaha Corporation).

## Song List

### 50 Classics

No.	Song Title	Composer
<b>Arrangements</b>		
1	Canon D dur	J. Pachelbel
2	Air On the G String	J. S. Bach
3	Jesus, Joy of Man's Desiring	J. S. Bach
4	Twinkle, Twinkle, Little Star	Traditional
5	Piano Sonata op.31-2 "Tempest" 3rd mov.	L. v. Beethoven
6	Ode to Joy	L. v. Beethoven
7	Wiegenlied op.98-2	F. P. Schubert
8	Grande Valse Brillante	F. F. Chopin
9	Polonaise op.53 "Héroïque"	F. F. Chopin
10	La Campanella	F. Liszt
11	Salut d'amour op.12	E. Elgar
12	From the New World	A. Dvořák
13	Sicilienne	G. U. Fauré
14	Clair de lune	C. A. Debussy
15	Jupiter (The Planets)	G. Holst
<b>Duets*</b>		
16	Menuett (Eine kleine Nachtmusik K.525)	W. A. Mozart
17	Menuett G dur	L. v. Beethoven
18	Marcia alla Turca	L. v. Beethoven
19	Piano Concerto No.1 op.11 2nd mov.	F. F. Chopin
20	The Nutcracker Medley	P. I. Tchaikovsky
<b>Original Compositions</b>		
21	Prelude (Wohltemperierte Klavier I No.1)	J. S. Bach
22	Menuett G dur BWV Anh.114	J. S. Bach
23	Piano Sonate No.15 K.545 1st mov.	W. A. Mozart
24	Turkish March	W. A. Mozart
25	Piano Sonate op.13 "Pathétique" 2nd mov.	L. v. Beethoven
26	Für Elise	L. v. Beethoven
27	Piano Sonate op.27-2 "Mondschein" 1st mov.	L. v. Beethoven
28	Impromptu op.90-2	F. P. Schubert
29	Frühlingslied op.62-6	J. L. F. Mendelssohn
30	Fantaisie-Impromptu	F. F. Chopin
31	Etude op.10-3 "Chanson de l'adieu"	F. F. Chopin
32	Etude op.10-12 "Revolutionary"	F. F. Chopin
33	Valse op.64-1 "Petit chien"	F. F. Chopin
34	Nocturne op.9-2	F. F. Chopin
35	Nocturne KK4a-16/BI 49 [Posth.]	F. F. Chopin
36	Träumerei	R. Schumann
37	Barcarolle	P. I. Tchaikovsky
38	La prière d'une Vierge	T. Badarzewska
39	Liebesträume No.3	F. Liszt
40	Blumenlied	G. Lange
41	Humoresque	A. Dvořák
42	Arietta	E. H. Grieg
43	Tango (España)	I. Albéniz
44	The Entertainer	S. Joplin
45	Maple Leaf Rag	S. Joplin
46	La Fille aux Cheveux de Lin	C. A. Debussy
47	Arabesque No.1	C. A. Debussy
48	Cakewalk	C. A. Debussy
49	Je te veux	E. Satie
50	Gymnopédies No.1	E. Satie

\* Regarding the "Duets" Songs, the right-hand part is for the right hand of the first player, the left-hand part is for the left hand of the first player, and Extra part is for the both hands of the second player.

## Rhythm List



Category	No.	Name
Pop&Rock	1	8Beat1
	2	8Beat2
	3	8Beat3
	4	16Beat1
	5	16Beat2
	6	Shuffle1
	7	Shuffle2
	8	Shuffle3
	9	Shuffle4
	10	8BeatBallad1
	11	8BeatBallad2
	12	16BeatBallad
	13	6-8Ballad1
	14	6-8Ballad2
	15	PopWaltz
	16	Funk
	17	Disco
	18	Twist
	19	Dance
	20	ChillOut
Jazz	21	FastJazz1
	22	FastJazz2
	23	FastJazz3
	24	SlowJazz1
	25	SlowJazz2
	26	SlowJazz3
	27	JazzWaltz
	28	Five-Four
World	29	Country
	30	Gospel
	31	Samba
	32	BossaNova
	33	Rumba
	34	Salsa
	35	AfroCuban
	36	Reggae
Kids&Holiday	37	KidsPop
	38	6-8March
	39	ChristmasSwing
	40	Christmas3-4



## Message List

Some message display remains open. In this case, press the [EXIT] button to close message display.

Message	Meaning
<b>Access error</b>	The operation has failed. The following causes can be considered. If the following are not responsible, the file may be damaged. <ul style="list-style-type: none"> <li>• The file operation is wrong. Follow the instructions in "Handling Song Files" (page 66) or "Backup"/"Restore" (pages 90 – 91).</li> <li>• The connected USB flash drive is not compatible with this instrument. For information on compatible USB flash drive, see page 75.</li> <li>• The protected Song on which you attempted the operation is defective.</li> </ul>
<b>Bluetooth pairing...</b>	The instrument is standing by for Bluetooth pairing. Refer to the instructions on page 79.
<b>Cannot be executed</b>	The operation has failed. The following causes can be considered. Solve the causes, and try again. <ul style="list-style-type: none"> <li>• The file operation you attempted cannot be executed to Preset Songs or an Audio Song. For information on the limitation of handling Song files, see page 66.</li> </ul>
<b>Change to Current Tempo</b>	This message indicates that you are applying the current tempo to the selected Song.
<b>Change to Current Voice</b>	This message indicates that you are changing the Voice of the Song with the current Voice.
<b>Completed</b>	This message indicates that the operation is completed. Go on to the next step.
<b>Completed Restart now</b>	Restore is completed. The instrument is automatically turned on again.
<b>Convert canceled</b>	This message appears when the convert operation is canceled.
<b>Convert completed to USB/USERFILES/</b>	This message appears when the convert operation to the "USER FILES" folder on a USB flash drive is completed.
<b>Convert to Audio</b>	This message appears during the convert operation.
<b>Copy completed to USB/USERFILES/</b>	This message appears when the copy operation to the "USER FILES" folder on a USB flash drive is completed.
<b>Copy completed to User</b>	This message appears when the copy operation to the "User" on this instrument is completed.
<b>Device busy</b>	The operation, such as converting to the Audio Song or Audio Song playback/recording, has failed. This message appears when you attempt to use a USB flash drive to which recording/deleting operations are repeated. Execute the Format operation after making sure there is no important data in the USB flash drive (page 107), and try again.
<b>Device removed</b>	This message appears when the USB flash drive is removed from the instrument.
<b>Duplicate name</b>	This message indicates that an identically named file already exists. Rename the file (page 71).
<b>Executing</b>	The instrument is executing the operation. Wait until the message disappears, then go on to the next step.
<b>Factory reset executing Memory Song excluded</b>	The default settings (except the Songs in the "User" category) have been restored (page 91). This message also appears if you press and hold down the C7 key and turn on the power to the instrument.
<b>Factory reset executing Memory Song included</b>	This message appears when the All Memory Clear (page 91) operation is completed. All settings of this instrument have been reset to the default settings. The Songs in the "User" category (page 45) and the Registration Memory (page 72) settings are deleted.
<b>Incompatible device</b>	This message appears when an incompatible USB flash drive is connected. Use a device whose compatibility has been confirmed by Yamaha (page 75).
<b>Internal hardware error</b>	A malfunction has occurred in the instrument. Contact your nearest Yamaha dealer or authorized distributor.
<b>Last power off invalid Checking memory</b>	This message appears when the power is turned on after turning off the power while handling a Song file (page 66) or saving a backup file (page 90). The internal memory is being checked while this message appears. If the internal settings are damaged, they will be reset to the default settings. If the Songs in the "User" are damaged, they will be deleted.
<b>Maximum no. of devices exceeded</b>	The number of devices exceed the limitation. Only one USB device can be connected. For details, see page 75.
<b>Memory full</b>	Since the capacity and the number of files in the "User"/USB flash drive are full, the operation cannot be completed. Delete some Songs in the "User"/USB flash drive (page 68) or move Songs to another USB flash drive (page 69), and try again.
<b>Move completed to USB/USERFILES/</b>	This message appears when the move operation to the "USER FILES" folder on a USB flash drive is completed.
<b>Move completed to User</b>	This message appears when the move operation to "User" on the instrument is completed.

Message	Meaning
<b>No device</b>	A USB flash drive was not connected to the instrument when you attempted to perform a device-related operation. Connect the device, and try again.
<b>No response from USB device</b>	The instrument cannot communicate with the connected USB device. Redo the connection (page 75). If you still see this message, the USB device may be damaged.
<b>Please wait</b>	The instrument is processing the data. Wait until the message disappears, then go on to the next step.
<b>Protected device</b>	This message appears when you attempt a file operation (page 66), record your performance or save the data on a read-only USB flash drive. Cancel the read-only setting, if possible, and try again. If you still see this message, the USB flash drive is internally protected (such as commercially available music data). You cannot make the file operation or record your performance to such a device.
<b>Read-only file</b>	You attempted a file operation to a read-only file. Use a read-only file after overriding the read-only setting.
<b>Remaining space on drive is low</b>	Since the remaining space on the "User"/USB flash drive is low, delete any unnecessary files (page 68) before recording.
<b>Same file name exists</b>	This message appears to prompt you to confirm if overwriting or not when executing a Copy/Move/MIDI to Audio operation.
<b>Song error</b>	This message appears, if a problem is found with the Song data when you select a Song or while the Song is playing. In this case, reselect the Song, and try again to play back. If the message still appears, the Song data may have been damaged.
<b>Song too large</b>	The size of Song data (MIDI/Audio) exceeds the limitation. The following causes can be considered. <ul style="list-style-type: none"> <li>• The Song size you attempt to play back exceeds the limitation. The limitation for playback is approx. 500KB (MIDI), 80 minutes (Audio).</li> <li>• The Song size exceeds the limitation during recording. The limitation for recording is approx. 500KB (MIDI), 80 minutes (Audio). The recording will end automatically and the recorded data before the end is saved.</li> <li>• The Song size exceeds the limitation during converting a MIDI Song to an Audio Song. The limitation is 80 minutes (Audio).</li> </ul>
<b>System limit</b>	This message appears when the number of files exceeds the system limit. The maximum number of files and folders which can be saved in a folder is 250. Try again after deleting/moving the unnecessary file(s).
<b>This data format is not supported</b>	This message appears when you attempted to load a Song of unsupported format to this instrument. Refer to the page 7 about supported Song formats.
<b>Unformatted device</b>	This message appears when you attempt to use an unformatted USB flash drive. Format it (page 107), and try again.
<b>Unsupported device</b>	This message appears when an unsupported USB flash drive is connected. Use a device whose compatibility has been confirmed by Yamaha (page 75).
<b>USB device overcurrent error</b>	Communication with the USB device has been cut off because of an abnormal power surge to the device. Disconnect the USB device from the [  ] (USB TO DEVICE) terminal and turn the [  ] (Standby/On) switch of the instrument standby and on again.
<b>USB hub cannot be used</b>	This instrument does not support a USB hub.
<b>USB power consumption exceeded</b>	When this message appears, use a device whose compatibility has been confirmed by Yamaha (page 75).
<b>Wrong device</b>	The file operation cannot be made to the connected USB flash drive. The following causes can be considered. <ul style="list-style-type: none"> <li>• The USB flash drive is not formatted. Format it (page 107), and try again.</li> <li>• The number of files exceeds the system limit. The maximum number of files and folders which can be saved in a folder is 250. Try again after deleting/moving the unnecessary file(s).</li> </ul>
<b>Wrong name</b>	The Song name is not appropriate. This message appears during the "Renaming files" (page 71) operation because of the following causes. Rename the Song correctly. <ul style="list-style-type: none"> <li>• No character has been input.</li> <li>• You used a period or space at the beginning/ending of a Song name.</li> </ul>

## Troubleshooting

When a message is displayed, refer to the “Message List” (page 113) for troubleshooting aid.

Problem	Possible Cause and Solution
The instrument does not turn on.	The instrument has not been plugged in properly. Securely connect the AC adaptor to the DC IN jack on the instrument and to the AC outlet (page 12).
The power is automatically turned off.	This is normal and due to the Auto Power Off function. If necessary, set the parameter of the Auto Power Off function (page 13).
The message “USB device overcurrent error” is shown and the USB device does not respond.	Communication with the USB device has been shut down because of the overcurrent to the USB device. Disconnect the device from the [↔] (USB TO DEVICE) terminal, then turn on the power of the instrument.
Noise is heard from the speakers or headphones.	The noise may be due to interference caused by the use of a mobile phone in close proximity to the instrument. Turn off the mobile phone, or use it further away from the instrument.
Noise is heard from the instrument’s speakers or headphones when using the instrument with your smart device, such as an iPhone/iPad.	When you use the instrument along with your smart device, we recommend that you set that device’s “Airplane Mode” to “ON” and then the Wi-Fi/Bluetooth setting to “ON” on your smart device in order to avoid noise caused by communication.
The overall volume is low, or no sound is heard.	The Master Volume is set too low; set it to an appropriate level using the [VOLUME] slider (page 13).
	The volume level for the keyboard performance is set too low. Adjust the volume balance to increase the keyboard volume via the “Song” menu display: “Volume” → “Song - Keyboard” (page 52).
	Headphones are connected when the Speaker setting is “Normal” (page 106). Disconnect the headphone plug.
	The Speaker setting is “Off.” Set the Speaker to “Normal” or “On” via the “System” menu display: “Utility” → “Speaker” (page 106).
Local Control is “Off.” Set Local Control “On” via the “System” menu display: “MIDI” → “Local Control” (page 105).	
The speakers do not switch off when a pair of headphones is connected to the [PHONES] jack.	The Speaker setting is “On.” Set the speaker setting to “Normal” via the “System” menu display: “Utility” → “Speaker” (page 106).
Pedals do not function.	The pedal cord may not be securely connected to the [PEDAL UNIT] jack. Be sure to insert the pedal cord all the way until the metal part of the cord plug disappears from view.
The on/off setting of the pedal connected to the AUX PEDAL jack is reversed.	Some types of pedals may turn on and off in opposite fashion. Set to the appropriate parameter via the “System” menu display: “Pedal” → “Aux Polarity” (page 104).
The keyboard volume is lower than the Song playback volume.	The volume level for the keyboard performance is set too low. Adjust the volume balance to increase the keyboard volume via the “Song” menu display: “Volume” → “Song - Keyboard” (page 52).
The buttons do not respond.	While you are using a function, some buttons not used for the function are disabled. If the Song is playing, stop playback. Otherwise, press the [EXIT] button to return to the Voice or Song display, Then, perform the desired operation.
Higher or lower notes do not sound correctly when the transpose or octave setting is made.	This instrument can cover the range of C -2 – G8 when you set the transposition or octave. If notes lower than C -2 are played, the sound is moved one octave higher. If notes higher than G8 are played, the sound is moved one octave lower.
Performance in Dual/Split/Duo mode is not recorded, or part data is lost unexpectedly.	Switching to Dual/Split/Duo mode in the middle of the Song is not recorded. Also, the recording part for the Voice 2 (Dual mode) or the left Voice (Split/Duo mode) is automatically assigned (page 57). If the assigned part already has data, the data will be overwritten and deleted when you record.
Depending on the selected Voice, the keyboard sound in Duo mode may be output from only one speaker.	This is because the default pan setting differs depending on the Voice. Change the settings from the “Voice” menu → “Voice Edit” → “Voice name” → “Pan” (page 96).

Problem	Possible Cause and Solution
The Song title is not correct.	The "Language" setting may be different than that is selected when you named the Song. Also, if the Song was recorded on another instrument, the title might be displayed incorrectly. Set the "Language" parameter (page 107) via the "System" menu display: "Utility" → "Language" → "Song" to change the setting. However, if the Song was recorded on another instrument, changing the "Language" parameter setting may not resolve the problem.
Menu display cannot be called up.	When Song is being played back, menu display other than "Voice" menu and "Song" menu will not appear. Stop the Song by pressing the [PLAY/PAUSE] button. Also, in the recording ready mode, only "Recording" menu display will appear.
Rhythm does not start.	"SyncStart" setting is on. Set "SyncStart" off in the "Metronome/Rhythm" menu display.
The contents of the Wireless LAN is not shown in the display even though the USB wireless LAN adaptor is connected.	Disconnect the USB wireless LAN adaptor and connect it again.
The Bluetooth-equipped smart device cannot be paired with nor connected to the instrument.	Check the Bluetooth function of the smart device is activated. To connect the smart device and the instrument via Bluetooth, both devices need to be functional.
	The smart device and the instrument need to be paired to connect each other via Bluetooth (page 79).
	In case there is a device (microwave oven, wireless LAN device, etc.) that outputs signals in the 2.4 GHz frequency band nearby, move this instrument away from the device that is emitting radio-frequency signals.
Sound input via the [AUX IN] jack or Bluetooth is interrupted.	The Noise Gate function of this instrument cuts unwanted noise from the input sound. However, this may result in wanted sounds also being cut, such as the soft decay sound of a piano. This is normal and not a sign of malfunction.

\*For information on whether Bluetooth functionality is included or not, refer to page 80.

# Specifications

<b>Product Name</b>		Digital Piano
<b>Size/Weight</b>		
Dimensions	Dimensions (W × H × D)	1,336 mm × 145 mm × 376 mm (52-5/8" × 5-11/16" × 14-13/16")
Weight	Weight	22.0 kg (48 lb, 8 oz)
<b>Control Interface</b>		
Keyboard	Number of Keys	88
	Type	GrandTouch-S™ Keyboard: wooden keys (white only), synthetic ebony and ivory key tops, escapement
	Touch Sensitivity	Hard2/Hard1/Medium/Soft1/Soft2/Fixed
Pedal	Number of pedals	3 (When using the pedal unit, LP-1/FC35)
	Assignable Functions	Sustain (Switch), Sustain (Continuous), Sostenuto, Soft, Pitch Bend Up, Pitch Bend Down, Rotary Speed, Vibe Rotor, Song Play/Pause
Display	Type	Full Dots LCD
	Size	198 × 100 dots
	Language	English, Japanese
Panel	Language	English
<b>Voices</b>		
Tone Generator	Piano Sound	Yamaha CFX, Bösendorfer Imperial
	Binaural Sampling	Yes ("CFX Grand" Voice only)
	Virtual Resonance Modeling (VRM)	Yes
	Grand Expression Modeling	Yes
Polyphony (max.)		256
Preset	Number of Voices	44 Voices + 18 Drum/SFX Kits + 480 XG Voices
Compatibility		XG (GM), GS (for Song playback), GM2 (for Song playback)
<b>Effects</b>		
Types	Reverb	7 types
	Chorus	3 types
	Master EQ	3 Preset + 1 User
	Insertion Effect	12 types
	Intelligent Acoustic Control (IAC)	Yes
	Stereophonic Optimizer	Yes
	Sound Boost	3 types
Functions	Dual	Yes
	Split	Yes
	Duo	Yes
<b>Songs</b>		
Preset	Number of Preset Songs	21 Voice Demo Songs + 50 Classics
MIDI Recording	Number of Songs	250
	Number of Tracks	16
	Data Capacity	Approx. 500 KB/Song
Audio Recording (USB memory)	Recording Time (max.)	80 minutes/Song
Compatible Data Format	Playback	SMF (Format 0, Format 1), WAV (44.1 kHz sample rate, 16-bit resolution, stereo)
	Recording	SMF (Format 0), WAV (44.1 kHz sample rate, 16-bit resolution, stereo)

<b>Functions</b>		
Piano Room		Yes
Rhythm	Number of Rhythms	40
Registration Memory	Number of Buttons	6 (x4 banks)
Overall Controls	Metronome	Yes
	Tempo Range	5 – 500
	Transpose	-12 – 0 – +12
	Tuning	414.8 – 440.0 – 466.8 Hz (approx. 0.2 Hz increments)
	Scale Type	7 types
	USB Audio Interface	44.1 kHz, 24 bit, Stereo
Bluetooth (May not have this functionality depending on the country in which you purchased the product.)	Audio	Supported profile: A2DP, Compatible codec: SBC
	MIDI	Comply with Bluetooth Low Energy MIDI Specification
	Bluetooth version	5.0
	Wireless output	Bluetooth Class 2
	Maximum communication distance	Approx. 10 m
	Radio Frequency	2,401 – 2,481 MHz
	Maximum output power (EIRP)	4 dBm
	Type of modulation	GFSK
<b>Storage and Connectivity</b>		
Storage	Internal Memory	Total maximum size approx. 1.4 MB
	External Drives	USB flash drive
Connectivity	Headphones	Standard stereo phone jack (x 2)
	MIDI	IN, OUT
	AUX IN	Stereo mini jack
	AUX OUT	Standard phone jack (L/L+R, R)
	AUX PEDAL	Yes
	USB TO DEVICE	Type A
	USB TO HOST	Type C
	DC IN	16 V
	PEDAL UNIT	Yes
<b>Amplifiers and Speakers</b>		
Amplifiers		(20 W + 6 W) x 2
Speakers		(Oval (12 cm x 6 cm) + 2.5 cm (dome)) x 2
<b>Power Supply</b>		
AC Adaptor		PA-300C (Output: DC 16 V, 2.4 A)
Power Consumption		18 W (When using PA-300C AC adaptor)
<b>Included Accessories</b>		<ul style="list-style-type: none"> <li>• Owner's Manual</li> <li>• Online Member Product Registration</li> <li>• Music rest</li> <li>• Foot pedal: FC3A</li> <li>• Power cord*, AC adaptor PA-300C*</li> </ul> <p>* May not be included depending on your area. Check with your Yamaha dealer.</p>
<b>Separately Sold Accessories</b> (May not be available depending on your area.)		<ul style="list-style-type: none"> <li>• Keyboard stand: L-515</li> <li>• Pedal unit: LP-1/FC35</li> <li>• Headphones: HPH-50/HPH-100/HPH-150</li> <li>• Footswitches: FC4A/FC5</li> <li>• Foot pedal: FC3A</li> <li>• AC adaptor: PA-300C</li> <li>• USB wireless LAN adaptor: UD-WL01</li> </ul>

\* The contents of this manual apply to the latest specifications as of the publishing date. To obtain the latest manual, access the Yamaha website then download the manual file. Since specifications, equipment or separately sold accessories may not be the same in every locale, please check with your Yamaha dealer.

# Index

---

## Numerics

50 Classics ..... 45, 66, 112

## A

AB Repeat ..... 50  
Accesspoint mode ..... 83  
App ..... 81  
Audio Loopback ..... 78, 106  
Audio Recording ..... 54  
Audio Song ..... 44  
Auto Power Off ..... 13, 106  
AUX IN ..... 76  
AUX OUT ..... 76

## B

Backup ..... 90  
Balance ..... 52, 97  
Bass ..... 43, 101  
Bell ..... 101  
Binaural Sampling ..... 14  
Bluetooth ..... 79, 82  
Body Resonance ..... 24  
Brightness ..... 24

## C

Chorus ..... 27  
Chorus Type List ..... 27  
Computer ..... 77  
Connectors ..... 74  
Contrast ..... 107  
Convert ..... 70  
Copy ..... 66, 68

## D

Damper Noise ..... 24, 25  
Damper pedal ..... 16  
Damper Resonance ..... 24  
Delete ..... 68  
Demo ..... 22, 45, 66  
Detailed settings ..... 94  
Display ..... 18  
Dual ..... 29, 31  
Duo ..... 32  
Duplex Scale ..... 25  
Duplex Scale Resonance ..... 24

## E

Edit (Song) ..... 99  
Edit (Voice) ..... 95  
Effect ..... 28  
Effect Type List ..... 28  
Ending ..... 43, 101

## F

Factory Reset ..... 91  
Fast forward ..... 47  
File ..... 66, 98  
Foot pedal ..... 15  
Footswitch ..... 15

## G

Grand Expression ..... 25  
Grand Expression Modeling ..... 25

## H

Half Pedal Point ..... 25, 104  
Half-pedal ..... 15  
Headphones ..... 14

## I

Infrastructure mode ..... 83  
Initialization ..... 90  
Intelligent Acoustic Control (IAC) ..... 13  
Intro ..... 43, 101

## L

Language ..... 107  
Lid Position ..... 24  
Local Control ..... 105

## M

Master EQ ..... 38  
Master EQ type list ..... 38  
Master Tune ..... 24, 35  
Menu ..... 94  
Message List ..... 113  
Metronome ..... 41, 101  
MIDI ..... 89, 105  
MIDI Recording ..... 54  
MIDI Song ..... 44  
Move ..... 66, 69

**O**

Octave .....95

**P**

Panel Lock .....40  
 Part Cancel .....48  
 Pedal .....15  
 Pedal Function List .....17  
 Pedal unit .....15  
 Piano Room .....23  
 Piano Setting .....95  
 Playback (Rhythm) .....43  
 Playback (Song) ..... 45, 53  
 Power .....12  
 Preset Voice List .....110

**R**

Rec'n'Share .....88  
 Recording ..... 54, 102  
 Registration Memory .....72  
 Rename .....71  
 Repeat ..... 49, 98  
 Restore .....91  
 Reverb ..... 24, 26  
 Reverb Depth .....24  
 Reverb Type List .....26  
 Rewind .....47  
 Rhythm ..... 43, 101  
 Rhythm List .....112

**S**

Scale Tune .....103  
 Smart device ..... 77, 81  
 Smart Pianist .....81  
 Soft pedal .....16  
 Song ..... 44, 66, 98  
 Song category .....45  
 Song List .....112  
 Song Repeat .....51  
 Sostenuato pedal .....16  
 Sound .....105  
 Sound Boost .....37  
 Sound Boost type list .....37  
 Speaker .....106  
 Split ..... 30, 31  
 Split Point ..... 30, 32, 104  
 Stage setup .....92  
 Stereophonic Optimizer .....14  
 String Resonance .....24  
 System .....103

**T**

Tempo .....41  
 Tempo (Song) .....47  
 Time Signature .....42  
 Touch ..... 24, 36, 104  
 Touch Sensitivity .....36  
 Touch Sensitivity list .....36  
 Track .....57  
 Transpose .....95, 98  
 Transpose (Keyboard) .....34  
 Transpose (Song) .....53  
 Troubleshooting .....115  
 Tuning .....35

**U**

USB .....45, 66  
 USB Audio Interface .....78  
 USB flash drive .....75  
 User .....45, 66  
 User Master EQ .....39

**V**

Version .....107  
 Voice .....20, 95  
 Voice Demo .....111  
 Voice Demo List .....111  
 Voice Edit .....95  
 Volume .....13  
 Volume (Metronome) .....101  
 Volume (Song) .....98  
 Volume balance .....52  
 VRM .....24, 25

**W**

Wi-Fi .....83  
 Wireless LAN ..... 84, 108  
 Wireless LAN Option .....109  
 WPS .....85

**X**

XG .....21



## About Trademarks

- Windows is a registered trademark of Microsoft® Corporation in the United States and other countries.
- iPhone, iPad, and Lightning are trademarks of Apple Inc., registered in the U.S. and other countries.
- Android is trademark of Google LLC.
- Wi-Fi is a registered trademark of Wi-Fi Alliance®.
- The Bluetooth® word mark and logos are registered trademarks owned by Bluetooth SIG, Inc. and any use of such marks by Yamaha Corporation is under license.



- The company names and product names in this manual are the trademarks or registered trademarks of their respective companies.

## For Open Source Software

The firmware of this product contains open source software. For copyright information and terms of use for each open source software, access the Yamaha website below and select your country. Then, click on “Documents and Data” and enter the model name.

### Yamaha Downloads

<https://download.yamaha.com/>

## For U.S.A.

This transmitter must not be co-located or operated in conjunction with any other antenna or transmitter.

(554-M01 FCC transmitter 01)

This equipment complies with FCC radiation exposure limits set forth for an uncontrolled environment and meets the FCC radio frequency (RF) Exposure Guidelines. This equipment has very low levels of RF energy that is deemed to comply without testing of specific absorption rate (SAR).

(554-M04 FCC portable 01)

## For Canada

This equipment complies with ISED radiation exposure limits set forth for an uncontrolled environment and meets RSS-102 of the ISED radio frequency (RF) Exposure rules as this equipment has very low levels of RF energy.

Cet équipement est conforme aux limites d'exposition aux rayonnements énoncées pour un environnement non contrôlé et respecte les règles d'exposition aux fréquences radioélectriques (RF) CNR-102 de l'ISDE puisque cet appareil a un niveau très bas d'énergie RF.

(0555-M05\_ised\_portable\_01)

This device contains licence-exempt transmitter(s)/receiver(s) that comply with Innovation, Science and Economic Development Canada's licence-exempt RSS(s). Operation is subject to the following two conditions:

1. This device may not cause interference.
2. This device must accept any interference, including interference that may cause undesired operation of the device.

L'émetteur/récepteur exempt de licence contenu dans le présent appareil est conforme aux CNR d'Innovation, Sciences et Développement économique Canada applicables aux appareils radio exempts de licence. L'exploitation est autorisée aux deux conditions suivantes :

1. L'appareil ne doit pas produire de brouillage ;
2. L'appareil doit accepter tout brouillage radioélectrique subi, même si le brouillage est susceptible d'en compromettre le fonctionnement.

(555-M13 ISED RSS 01)

## For Mexico

La operación de este equipo está sujeta a las siguientes dos condiciones: (1) es posible que este equipo o dispositivo no cause interferencia perjudicial y (2) este equipo o dispositivo debe aceptar cualquier interferencia, incluyendo la que pueda causar su operación no deseada.

(556-M02 MX operating condition 01)

## For United Kingdom

### **SIMPLIFIED UK DECLARATION OF CONFORMITY**

Hereby, Yamaha Corporation declares that the [P-525] is in compliance with the Product Security and Telecommunications Infrastructure Regulations. The full text of the UK Declaration of Conformity is available at the following internet address:

<https://europe.yamaha.com/en/support/compliance/doc.html>

## For European Union and United Kingdom

<b>EN</b>	<b>SIMPLIFIED EU DECLARATION OF CONFORMITY / SIMPLIFIED UK DECLARATION OF CONFORMITY</b>
<p>Hereby, Yamaha Corporation declares that the radio equipment type [P-525] is in compliance with Directive 2014/53/EU and the radio equipment regulations of UK. The full texts of the EU declaration of conformity and the UK declaration of conformity are available at the following internet address: <a href="https://europe.yamaha.com/en/support/compliance/doc.html">https://europe.yamaha.com/en/support/compliance/doc.html</a></p>	
<b>FR</b>	<b>DECLARATION UE DE CONFORMITE SIMPLIFIEE</b>
<p>Le soussigné, Yamaha Corporation, déclare que l'équipement radioélectrique du type [P-525] est conforme à la directive 2014/53/UE. Le texte complet de la déclaration UE de conformité est disponible à l'adresse internet suivante : <a href="https://europe.yamaha.com/en/support/compliance/doc.html">https://europe.yamaha.com/en/support/compliance/doc.html</a></p>	
<b>DE</b>	<b>VEREINFACHTE EU-KONFORMITÄTSERKLÄRUNG</b>
<p>Hiermit erklärt Yamaha Corporation, dass der Funkanlagentyp [P-525] der Richtlinie 2014/53/EU entspricht. Der vollständige Text der EU-Konformitätserklärung ist unter der folgenden Internetadresse verfügbar: <a href="https://europe.yamaha.com/en/support/compliance/doc.html">https://europe.yamaha.com/en/support/compliance/doc.html</a></p>	
<b>SV</b>	<b>FÖRENKLAD EU-FÖRSÄKRAN OM ÖVERENSSTÄMMELE</b>
<p>Härmed försäkras Yamaha Corporation att denna typ av radioutrustning [P-525] överensstämmer med direktiv 2014/53/EU. Den fullständiga texten till EU-försäkran om överensstämmelse finns på följande webbadress: <a href="https://europe.yamaha.com/en/support/compliance/doc.html">https://europe.yamaha.com/en/support/compliance/doc.html</a></p>	
<b>IT</b>	<b>DICHIARAZIONE DI CONFORMITÀ UE SEMPLIFICATA</b>
<p>Il fabbricante, Yamaha Corporation, dichiara che il tipo di apparecchiatura radio [P-525] è conforme alla direttiva 2014/53/UE. Il testo completo della dichiarazione di conformità UE è disponibile al seguente indirizzo Internet: <a href="https://europe.yamaha.com/en/support/compliance/doc.html">https://europe.yamaha.com/en/support/compliance/doc.html</a></p>	
<b>ES</b>	<b>DECLARACIÓN UE DE CONFORMIDAD SIMPLIFICADA</b>
<p>Por la presente, Yamaha Corporation declara que el tipo de equipo radioeléctrico [P-525] es conforme con la Directiva 2014/53/UE. El texto completo de la declaración UE de conformidad está disponible en la dirección Internet siguiente: <a href="https://europe.yamaha.com/en/support/compliance/doc.html">https://europe.yamaha.com/en/support/compliance/doc.html</a></p>	
<b>PT</b>	<b>DECLARAÇÃO UE DE CONFORMIDADE SIMPLIFICADA</b>
<p>O(a) abaixo assinado(a) Yamaha Corporation declara que o presente tipo de equipamento de rádio [P-525] está em conformidade com a Diretiva 2014/53/UE. O texto integral da declaração de conformidade está disponível no seguinte endereço de Internet: <a href="https://europe.yamaha.com/en/support/compliance/doc.html">https://europe.yamaha.com/en/support/compliance/doc.html</a></p>	
<b>NL</b>	<b>VEREENVOUDIGDE EU-CONFORMITEITSVERKLARING</b>
<p>Hierbij verklaar ik, Yamaha Corporation, dat het type radioapparatuur [P-525] conform is met Richtlijn 2014/53/EU. De volledige tekst van de EU-conformiteitsverklaring kan worden geraadpleegd op het volgende internetadres: <a href="https://europe.yamaha.com/en/support/compliance/doc.html">https://europe.yamaha.com/en/support/compliance/doc.html</a></p>	
<b>BG</b>	<b>ОПРОСТЕНА ЕС ДЕКЛАРАЦИЯ ЗА СЪОТВЕТСТВИЕ</b>
<p>С настоящото Yamaha Corporation декларира, че този тип радиосъоръжение [P-525] е в съответствие с Директива 2014/53/ЕС. Цялостният текст на ЕС декларацията за съответствие може да се намери на следния интернет адрес: <a href="https://europe.yamaha.com/en/support/compliance/doc.html">https://europe.yamaha.com/en/support/compliance/doc.html</a></p>	
<b>CS</b>	<b>ZJEDNODUŠENÉ EU PROHLÁŠENÍ O SHODĚ</b>
<p>Tímto Yamaha Corporation prohlašuje, že typ rádiového zařízení [P-525] je v souladu se směrnicí 2014/53/EU. Úplné znění EU prohlášení o shodě je k dispozici na této internetové adrese: <a href="https://europe.yamaha.com/en/support/compliance/doc.html">https://europe.yamaha.com/en/support/compliance/doc.html</a></p>	
<b>DA</b>	<b>FORENKLET EU-OVERENSSTEMMELSESERKLÆRING</b>
<p>Hermed erklærer Yamaha Corporation, at radioudstyrstypen [P-525] er i overensstemmelse med direktiv 2014/53/EU. EU-overensstemmelseserklæringens fulde tekst kan findes på følgende internetadresse: <a href="https://europe.yamaha.com/en/support/compliance/doc.html">https://europe.yamaha.com/en/support/compliance/doc.html</a></p>	

<b>ET</b>	<b>LIHTSUSTATUD ELI VASTAVUSDEKLARATSIOON</b>
	Käesolevaga deklareerib Yamaha Corporation, et käesolev raadioseadme tüüp [P-525] vastab direktiivi 2014/53/EL nõuetele. ELi vastavusdeklaratsiooni täielik tekst on kättesaadav järgmisel internetiaadressil: <a href="https://europe.yamaha.com/en/support/compliance/doc.html">https://europe.yamaha.com/en/support/compliance/doc.html</a>
<b>EL</b>	<b>ΑΠΛΟΥΣΤΕΥΜΕΝΗ ΔΗΛΩΣΗ ΣΥΜΜΟΡΦΩΣΗΣ ΕΕ</b>
	Με την παρούσα ο/η Yamaha Corporation, δηλώνει ότι ο ραδιοεξοπλισμός [P-525] πληροί την οδηγία 2014/53/ΕΕ. Το πλήρες κείμενο της δήλωσης συμμόρφωσης ΕΕ διατίθεται στην ακόλουθη ιστοσελίδα στο διαδίκτυο: <a href="https://europe.yamaha.com/en/support/compliance/doc.html">https://europe.yamaha.com/en/support/compliance/doc.html</a>
<b>HR</b>	<b>POJEDNOSTAVLJENA EU IZJAVA O SUKLADNOSTI</b>
	Yamaha Corporation ovime izjavljuje da je radijska oprema tipa [P-525] u skladu s Direktivom 2014/53/EU. Cjeloviti tekst EU izjave o sukladnosti dostupan je na sljedećoj internetskoj adresi: <a href="https://europe.yamaha.com/en/support/compliance/doc.html">https://europe.yamaha.com/en/support/compliance/doc.html</a>
<b>LV</b>	<b>VIENKĀRŠOTA ES ATBILSTĪBAS DEKLARĀCIJA</b>
	Ar šo Yamaha Corporation deklarē, ka radioiekārta [P-525] atbilst Direktīvai 2014/53/ES. Pilns ES atbilstības deklarācijas teksts ir pieejams šādā interneta vietnē: <a href="https://europe.yamaha.com/en/support/compliance/doc.html">https://europe.yamaha.com/en/support/compliance/doc.html</a>
<b>LT</b>	<b>SUPAPRASTINTA ES ATITIKTIES DEKLARACIJA</b>
	Aš, Yamaha Corporation, patvirtinu, kad radijo įrenginių tipas [P-525] atitinka Direktyvą 2014/53/ES. Visas ES atitikties deklaracijos tekstas prieinamas šiuo interneto adresu: <a href="https://europe.yamaha.com/en/support/compliance/doc.html">https://europe.yamaha.com/en/support/compliance/doc.html</a>
<b>HU</b>	<b>EGYSZERŰSÍTETT EU-MEGFELELŐSÉGI NYILATKOZAT</b>
	Yamaha Corporation igazolja, hogy a [P-525] típusú rádióberendezés megfelel a 2014/53/EU irányelvnek. Az EU-megfelelőségi nyilatkozat teljes szövege elérhető a következő internetes címen: <a href="https://europe.yamaha.com/en/support/compliance/doc.html">https://europe.yamaha.com/en/support/compliance/doc.html</a>
<b>PL</b>	<b>UPROSZCZONA DEKLARACJA ZGODNOŚCI UE</b>
	Yamaha Corporation niniejszym oświadczam, że typ urządzenia radiowego [P-525] jest zgodny z dyrektywą 2014/53/UE. Pełny tekst deklaracji zgodności UE jest dostępny pod następującym adresem internetowym: <a href="https://europe.yamaha.com/en/support/compliance/doc.html">https://europe.yamaha.com/en/support/compliance/doc.html</a>
<b>RO</b>	<b>DECLARAȚIA UE DE CONFORMITATE SIMPLIFICATĂ</b>
	Prin prezenta, Yamaha Corporation declară că tipul de echipamente radio [P-525] este în conformitate cu Directiva 2014/53/UE. Textul integral al declarației UE de conformitate este disponibil la următoarea adresă internet: <a href="https://europe.yamaha.com/en/support/compliance/doc.html">https://europe.yamaha.com/en/support/compliance/doc.html</a>
<b>SK</b>	<b>ZJEDNODUŠENÉ EÚ VYHLÁSENIE O ZHODE</b>
	Yamaha Corporation týmto vyhlasuje, že rádiové zariadenie typu [P-525] je v súlade so smernicou 2014/53/EÚ. Úplné EÚ vyhlásenie o zhode je k dispozícii na tejto internetovej adrese: <a href="https://europe.yamaha.com/en/support/compliance/doc.html">https://europe.yamaha.com/en/support/compliance/doc.html</a>
<b>SL</b>	<b>POENOSTAVLJENA IZJAVA EU O SKLADNOSTI</b>
	Yamaha Corporation potrjuje, da je tip radijske opreme [P-525] skladen z Direktivo 2014/53/EU. Celotno besedilo izjave EU o skladnosti je na voljo na naslednjem spletnem naslovu: <a href="https://europe.yamaha.com/en/support/compliance/doc.html">https://europe.yamaha.com/en/support/compliance/doc.html</a>
<b>FI</b>	<b>YKSINKERTAISTETTU EU-VAATIMUSTENMUKAISUUSVAKUUTUS</b>
	Yamaha Corporation vakuuttaa, että radiolaitetyyppi [P-525] on direktiivin 2014/53/EU mukainen. EU-vaatimustenmukaisuusvakuutuksen täysimittainen teksti on saatavilla seuraavassa internetosoitteessa: <a href="https://europe.yamaha.com/en/support/compliance/doc.html">https://europe.yamaha.com/en/support/compliance/doc.html</a>
<b>TR</b>	<b>BASİTLEŞTİRİLMİŞ AVRUPA BİRLİĞİ UYGUNLUK BİLDİRİMİ</b>
	İşbu belge ile, Yamaha Corporation, radyo cihaz tipinin [P-525], Direktif 2014/53/ AB'ye uygunluğunu beyan eder. AB uyumu beyanının tam metni aşağıdaki internet adresinden edinilebilir: <a href="https://europe.yamaha.com/en/support/compliance/doc.html">https://europe.yamaha.com/en/support/compliance/doc.html</a>

(559-M01 RED DoC URL 03)



### **Information for users on collection and disposal of old equipment:**

This symbol on the products, packaging, and/or accompanying documents means that used electrical and electronic products should not be mixed with general household waste. For proper treatment, recovery and recycling of old products, please take them to applicable collection points, in accordance with your national legislation.

By disposing of these products correctly, you will help to save valuable resources and prevent any potential negative effects on human health and the environment which could otherwise arise from inappropriate waste handling.

For more information about collection and recycling of old products, please contact your local municipality, your waste disposal service or the point of sale where you purchased the items.

### **For business users in the European Union:**

If you wish to discard electrical and electronic equipment, please contact your dealer or supplier for further information.

### **Information on Disposal in other Countries outside the European Union:**

This symbol is only valid in the European Union. If you wish to discard these items, please contact your local authorities or dealer and ask for the correct method of disposal.

(58-M02 WEEE en 01)



### **Informations concernant la collecte et le traitement des déchets d'équipements électriques et électroniques**

Le symbole sur les produits, l'emballage et/ou les documents joints signifie que les produits électriques ou électroniques usagés ne doivent pas être mélangés avec les déchets domestiques habituels.

Pour un traitement, une récupération et un recyclage appropriés des déchets d'équipements électriques et électroniques, veuillez les déposer aux points de collecte prévus à cet effet, conformément à la réglementation nationale.

En vous débarrassant correctement des déchets d'équipements électriques et électroniques, vous contribuerez à la sauvegarde de précieuses ressources et à la prévention de potentiels effets négatifs sur la santé humaine qui pourraient advenir lors d'un traitement inapproprié des déchets.

Pour plus d'informations à propos de la collecte et du recyclage des déchets d'équipements électriques et électroniques, veuillez contacter votre municipalité, votre service de traitement des déchets ou le point de vente où vous avez acheté les produits.

### **Pour les professionnels dans l'Union européenne :**

Si vous souhaitez vous débarrasser des déchets d'équipements électriques et électroniques, veuillez contacter votre vendeur ou fournisseur pour plus d'informations.

### **Informations sur la mise au rebut dans d'autres pays en dehors de l'Union européenne :**

Ce symbole est seulement valable dans l'Union européenne. Si vous souhaitez vous débarrasser de déchets d'équipements électriques et électroniques, veuillez contacter les autorités locales ou votre fournisseur et demander la méthode de traitement appropriée.

(58-M02 WEEE fr 01)



### **Información para usuarios sobre la recogida y eliminación de los equipos antiguos**

Este símbolo en los productos, embalajes y documentos anexos significa que los productos eléctricos y electrónicos no deben mezclarse con los desperdicios domésticos normales.

Para el tratamiento, recuperación y reciclaje apropiados de los productos antiguos, llévelos a puntos de reciclaje correspondientes, de acuerdo con la legislación nacional.

Al deshacerse de estos productos de forma correcta, ayudará a ahorrar recursos valiosos y a impedir los posibles efectos desfavorables en la salud humana y en el entorno que de otro modo se producirían si se trataran los desperdicios de modo inapropiado.

Para obtener más información acerca de la recogida y el reciclaje de los productos antiguos, póngase en contacto con las autoridades locales, con el servicio de eliminación de basuras o con el punto de venta donde adquirió los artículos.

### **Para los usuarios empresariales de la Unión Europea:**

Si desea desechar equipos eléctricos y electrónicos, póngase en contacto con su vendedor o proveedor para obtener más información.

### **Información sobre la eliminación en otros países fuera de la Unión Europea:**

Este símbolo solo es válido en la Unión Europea. Si desea desechar estos artículos, póngase en contacto con las autoridades locales o con el vendedor y pregúnteles el método correcto.

(58-M02 WEEE es 01)



**Important Notice:  
U.S. LIMITED WARRANTY for Customers in the United States**

For detailed information about this Yamaha product and warranty service, please either visit the following website address (printable file is available at our website) or contact Customer Service at the address or telephone number identified below.

**Website Address:**  
[Yamaha.io/PSeriesWarranty](http://Yamaha.io/PSeriesWarranty)

**Customer Service:**  
Yamaha Corporation of America  
6600 Orangethorpe Avenue, Buena Park, CA 90620  
Telephone: 800-854-1569

# Important Notice: Guarantee Information for customers in European Economic Area (EEA) and Switzerland

<p><b>Important Notice: Guarantee Information for customers in EEA* and Switzerland</b></p> <p>For detailed guarantee information about this Yamaha product, and Pan-EEA* and Switzerland warranty service, please either visit the website address below (Printable file is available at our website) or contact the Yamaha representative office for your country. * EEA: European Economic Area</p>	English
<p><b>Wichtiger Hinweis: Garantie-Information für Kunden in der EWR* und der Schweiz</b></p> <p>Für nähere Garantie-Information über dieses Produkt von Yamaha, sowie über den Pan-EWR*- und Schweizer Garantieservice, besuchen Sie bitte entweder die folgend angegebene Internetadresse (eine druckfähige Version befindet sich auch auf unserer Webseite), oder wenden Sie sich an den für Ihr Land zuständigen Yamaha-Vertrieb. *EWR: Europäischer Wirtschaftsraum</p>	Deutsch
<p><b>Remarque importante: informations de garantie pour les clients de l'EEE et la Suisse</b></p> <p>Pour des informations plus détaillées sur la garantie de ce produit Yamaha et sur le service de garantie applicable dans l'ensemble de l'EEE ainsi qu'en Suisse, consultez notre site Web à l'adresse ci-dessous (le fichier imprimable est disponible sur notre site Web) ou contactez directement Yamaha dans votre pays de résidence. * EEE : Espace Economique Européen</p>	Français
<p><b>Belangrijke mededeling: Garantie-informatie voor klanten in de EER* en Zwitserland</b></p> <p>Voor gedetailleerde garantie-informatie over dit Yamaha-product en de garantieservice in heel de EER* en Zwitserland, gaat u naar de onderstaande website (u vindt een afdrukbare bestand op onze website) of neemt u contact op met de vertegenwoordiging van Yamaha in uw land. * EER: Europese Economische Ruimte</p>	Nederlands
<p><b>Aviso importante: información sobre la garantía para los clientes del EEE* y Suiza</b></p> <p>Para una información detallada sobre este producto Yamaha y sobre el soporte de garantía en la zona EEE* y Suiza, visite la dirección web que se incluye más abajo (la versión del archivo para imprimir esta disponible en nuestro sitio web) o póngase en contacto con el representante de Yamaha en su país. * EEE: Espacio Económico Europeo</p>	Español
<p><b>Aviso importante: informazioni sulla garanzia per i clienti residenti nell'EEA* e in Svizzera</b></p> <p>Per informazioni dettagliate sulla garanzia relativa a questo prodotto Yamaha e l'assistenza in garanzia nei paesi EEA* e in Svizzera, potete consultare il sito Web all'indirizzo riportato di seguito (è disponibile il file in formato stampabile) oppure contattare l'ufficio di rappresentanza locale della Yamaha. * EEA: Area Economica Europea</p>	Italiano
<p><b>Aviso importante: informações sobre as garantias para clientes da AEE* e da Suíça</b></p> <p>Para obter uma informação pormenorizada sobre este produto da Yamaha e sobre o serviço de garantia na AEE* e na Suíça, visite o site a seguir (o arquivo para impressão está disponível no nosso site) ou entre em contato com o escritório de representação da Yamaha no seu país. * AEE: Área Económica Europeia</p>	Português
<p><b>Σημαντική σημείωση: Πληροφορίες εγγύησης για τους πελάτες στον ΕΟΧ* και Ελλάδα</b></p> <p>Για λεπτομερείς πληροφορίες εγγύησης σχετικά με το παρόν προϊόν της Yamaha και την κάλυψη εγγύησης σε όλες τις χώρες του ΕΟΧ και την Ελλάδα, επισκεφτείτε την παρακάτω ιστοσελίδα (Εκτυπώσιμη μορφή είναι διαθέσιμη στην ιστοσελίδα μας) ή απευθυνθείτε στην αντιπροσωπεία της Yamaha στη χώρα σας. * ΕΟΧ: Ευρωπαϊκός Οικονομικός Χώρος</p>	Ελληνικά
<p><b>Viktigt: Garantiinformation för kunder i EES-området* och Schweiz</b></p> <p>För detaljerad information om denna Yamaha-produkt samt garantiservice i hela EES-området* och Schweiz kan du antingen besöka nedanstående webbadress (en utskriftsvänlig fil finns på webbplatsen) eller kontakta Yamahas officiella representant i ditt land. * EES: Europeiska Ekonomiska Samarbetsområdet</p>	Svenska
<p><b>Viktig merknad: Garantiinformasjon for kunder i EØS* og Sveits</b></p> <p>Detaljert garantiinformasjon om dette Yamaha-produktet og garantiservice for hele EØS-området* og Sveits kan fås enten ved å besøke nettstedene nedenfor (utskriftsversjon finnes på våre nettsider) eller kontakte kontakta Yamaha-kontoret i landet der du bor. *EØS: Det europeiske økonomiske samarbeidsområdet</p>	Norsk
<p><b>Vigtig oplysning: Garantioplysninger til kunder i EØO* og Schweiz</b></p> <p>De kan finde detaljerede garantioplysninger om dette Yamaha-produkt og den fælles garantiserviceordning for EØO* (og Schweiz) ved at besøge det websted, der er angivet nedenfor (der findes en fil, som kan udskrives, på vores websted), eller ved at kontakte Yamahas nationale repræsentationskontor i det land, hvor De bor. * EØO: Det Europæiske Økonomiske Område</p>	Dansk
<p><b>Tärkeä ilmoitus: Takuutiedot Euroopan talousalueen (ETA)* ja Sveitsin asiakkaille</b></p> <p>Tämän Yamaha-tuotteen sekä ETA-alueen ja Sveitsin takuuta koskevat yksityiskohtaiset tiedot saatte alla olevasta nettiosoitteesta. (Tulostettava tiedosto saatavissa sivustollamme.) Voitte myös ottaa yhteyttä paikalliseen Yamaha-edustajaan. *ETA: Euroopan talousalue</p>	Suomi
<p><b>Ważne: Warunki gwarancyjne obowiązujące w EOG* i Szwajcarii</b></p> <p>Aby dowiedzieć się więcej na temat warunków gwarancyjnych tego produktu firmy Yamaha i serwisu gwarancyjnego w całym EOG* i Szwajcarii, należy odwiedzić wskazaną poniżej stronę internetową (Plik gotowy do wydruku znajduje się na naszej stronie internetowej) lub skontaktować się z przedstawicielstwem firmy Yamaha w swoim kraju. * EOG — Europejski Obszar Gospodarczy</p>	Polski
<p><b>Důležité oznámení: Záruční informace pro zákazníky v EHS* a ve Švýcarsku</b></p> <p>Podrobné záruční informace o tomto produktu Yamaha a záručním servisu v celém EHS* a ve Švýcarsku naleznete na níže uvedené webové adrese (soubor k tisku je dostupný na našich webových stránkách) nebo se můžete obrátit na zastoupení firmy Yamaha ve své zemi. * EHS: Evropský hospodářský prostor</p>	Česky
<p><b>Fontos figyelemzetetés: Garancia-információk az EGT* területén és Svájcban élő vásárlók számára</b></p> <p>A jelen Yamaha termékre vonatkozó részletes garancia-információk, valamint az EGT*-re és Svájcra kiterjedő garanciális szolgáltatás tekintetében keresse fel webhelyünket az alábbi címen (a webhelyen nyomtatható fájl is talál), vagy pedig lépjen kapcsolatba az országában működő Yamaha képviselői irodával. * EGT: Európai Gazdasági Térség</p>	Magyar
<p><b>Oluline märkus: Garantiteave Euroopa Majanduspiirkonna (EMP)* ja Sveitsi klientidele</b></p> <p>Täpsema teabe saamiseks selle Yamaha toote garantii ning kogu Euroopa Majanduspiirkonna ja Sveitsi garantiiteeninduse kohta, külastage palun veebisaiti alljärgneval aadressil (meie saidil on saadaval printitav fail) või pöörduge Teie regiooni Yamaha esinduse poole. * EMP: Euroopa Majanduspiirkond</p>	Eesti keel
<p><b>Svarīgs paziņojums: garantijas informācija klientiem EEZ* un Šveicē</b></p> <p>Lai saņemtu detalizētu garantijas informāciju par šo Yamaha produktu, kā arī garantijas apkalpošanu EEZ* un Šveicē, lūdz, apmeklējiet zemāk norādīto tīmekļa vietnes adresi (tīmekļa vietnē ir pieejams drukājams fails) vai sazinieties ar jūsu valsti apkalpojošo Yamaha pārstāvniecību. * EEZ: Eiropas Ekonomikas zona</p>	Latviešu
<p><b>Dėmesio: informacija dėl garantijos pirkėjams EEE* ir Šveicarijoje</b></p> <p>Jei reikia išsamios informacijos apie šį „Yamaha“ produktą ir jo techninę priežiūrą visoje EEE* ir Šveicarijoje, apsilankykite mūsų svetainėje toliau nurodytu adresu (svetainėje yra spausdintinas failas) arba kreipkitės į „Yamaha“ atstovybę savo šaliai. *EEE – Europos ekonominė erdvė</p>	Lietuvių kalba
<p><b>Dôležité upozornenie: Informácie o záruke pre zákazníkov v EHP* a Švajčiarsku</b></p> <p>Podrobné informácie o záruke týkajúce sa tohto produktu od spoločnosti Yamaha a garančnom servise v EHP* a Švajčiarsku nájdete na webovej stránke uvedenej nižšie (na našej webovej stránke je k dispozícii súbor na tlač) alebo sa obráťte na zástupcu spoločnosti Yamaha vo svojej krajine. * EHP: Európsky hospodársky priestor</p>	Slovenčina
<p><b>Pomembno obvestilo: Informacije o garanciji za kupce v EGP* in Švici</b></p> <p>Za podrobnejše informacije o tem Yamahinem izdelku ter garancijskem servisu v celotnem EGP in Švici, obiščite spletno mesto, ki je navedeno spodaj (natisljiva datoteka je na voljo na našem spletnem mestu), ali se obrnite na Yamahinega predstavnika v svoji državi. * EGP: Evropski gospodarski prostor</p>	Slovenščina
<p><b>Важно съобщение: Информация за гаранцията за клиенти в ЕИП* и Швейцария</b></p> <p>За подробна информация за гаранцията за този продукт на Yamaha и гаранционното обслужване в паневропейската зона на ЕИП* и Швейцария или посетете посочения по-долу уеб сайт (на нашия уеб сайт има файл за печат), или се свържете с представителния офис на Yamaha във вашата страна. * ЕИП: Европейско икономическо пространство</p>	Български език
<p><b>Notificare importantă: Informații despre garanție pentru clienții din SEE* și Elveția</b></p> <p>Pentru informații detaliate privind acest produs Yamaha și serviciul de garanție Pan-SEE* și Elveția, vizitați site-ul la adresa de mai jos (fișierul imprimabil este disponibil pe site-ul nostru) sau contactați biroul reprezentanței Yamaha din țara dumneavoastră. * SEE: Spațiul Economic European</p>	Limba română
<p><b>Važna obavijest: Informacije o jamstvu za države EGP-a i Švicarske</b></p> <p>Za detaljne informacije o jamstvu za ovaj Yamahin proizvod te jamstvenom servisu za cijeli EGP i Švicarsku, molimo Vas da posjetite web-stranicu navedenu u nastavku ili kontaktirate ovlaštenog Yamahinog dobavljača u svojoj zemlji. * EGP: Evropski gospodarski prostor</p>	Hrvatski

<https://europe.yamaha.com/warranty/>

# Yamaha Worldwide Representative Offices

## English

For details on the product(s), contact your nearest Yamaha representative or the authorized distributor, found by accessing the 2D barcode below.

## Deutsch

Wenden Sie sich für nähere Informationen zu Produkten an eine Yamaha-Vertretung oder einen autorisierten Händler in Ihrer Nähe. Diese finden Sie mithilfe des unten abgebildeten 2D-Strichcodes.

## Français

Pour obtenir des informations sur le ou les produits, contactez votre représentant ou revendeur agréé Yamaha le plus proche. Vous le trouverez à l'aide du code-barres 2D ci-dessous.

## Español

Para ver información detallada sobre el producto, contacte con su representante o distribuidor autorizado Yamaha más cercano. Lo encontrará escaneando el siguiente código de barras 2D.

## Italiano

Per dettagli sui prodotti, contattare il rappresentante Yamaha o il distributore autorizzato più vicino, che è possibile trovare tramite il codice a barre 2D in basso.

## Português

Para mais informações sobre o(s) produto(s), fale com seu representante da Yamaha mais próximo ou com o distribuidor autorizado acessando o código de barras 2D abaixo.

## Русский

Чтобы узнать подробнее о продукте (продуктах), свяжитесь с ближайшим представителем или авторизованным дистрибьютором Yamaha, воспользовавшись двухмерным штрихкодом ниже.

## 简体中文

如需有关产品的详细信息,请联系距您最近的 Yamaha 代表或授权经销商,可通过访问下方的二维码找到这些代表或经销商的信息。

## 繁體中文

如需產品的詳細資訊,請聯絡與您距離最近的 Yamaha 銷售代表或授權經銷商,您可以掃描下方的二維條碼查看相關聯絡資料。

## 한국어

제품에 대한 자세한 정보는 아래 2D 바코드에 액세스하여 가까운 Yamaha 담당 판매점 또는 공식 대리점에 문의하십시오.



[https://manual.yamaha.com/dmi/address\\_list/](https://manual.yamaha.com/dmi/address_list/)

Head Office/Manufacturer: Yamaha Corporation 10-1, Nakazawa-cho, Chuo-ku, Hamamatsu, 430-8650, Japan

Importer (European Union): Yamaha Music Europe GmbH Siemensstrasse 22-34, 25462 Rellingen, Germany

Importer (United Kingdom): Yamaha Music Europe GmbH (UK) Sherbourne Drive, Tilbrook, Milton Keynes, MK7 8BL, United Kingdom

DMI35

Yamaha Global Site  
<https://www.yamaha.com/>  
Yamaha Downloads  
<https://download.yamaha.com/>

© 2023 Yamaha Corporation  
Published 11/2023 MWMA-C1



VHC0460