

SPEAKER PACKAGE

PACKAGE ENCEINTES

NS-B20

NS-C20

NS-SWP20

Precautions

Please read the following operating precautions before use. Yamaha will not be held responsible for any damage and/or injury caused by not following the cautions below.

1. To assure the finest performance, please read this manual carefully. Keep it in a safe place for future reference.
2. Install the speakers in a cool, dry, clean place – away from windows, sources of heat, sources of excessive vibration, dust, moisture or cold. Avoid sources of electrical humming (e.g., transformers and motors). To prevent fire or electric shock, do not expose the speakers to rain or water.
3. To prevent the enclosure from warping or discoloring, do not expose the speakers to direct sunlight or excessive humidity.
4. Avoid installing the speakers where foreign objects may fall onto them and/or where they may be exposed to liquid dripping or splashing.
5. Do not place the following objects on top of the speakers:
 - Other components, as they might damage or discolor the surface of the speakers.
 - Burning objects (e.g., candles), as they might cause fire, damage to the speakers or personal injury.
 - Containers of liquid, as they might spill and cause electric shock to the user or damage to the speakers.
6. Do not place the speakers where they are liable to be knocked over or struck by falling objects. Stable placement will also ensure better sound performance.
7. Placing the speakers on the same shelf or rack as the turntable can result in feedback.
8. Any time you note distortion, reduce the volume control on your amplifier to lower setting. Never allow your amplifier to be driven into “clipping”. Otherwise, the speakers may be damaged.
9. When using an amplifier with a rated output power higher than the nominal input power of the speakers, care should be taken not to exceed the maximum input of the speakers.
10. Do not attempt to clean the speakers with chemical solvents as this might damage the finish. Use a clean, dry cloth.
11. Do not attempt to modify or fix the speakers. Contact qualified Yamaha service personnel when service is needed. The cabinet should never be opened for any reason.
12. Be sure to read the “Troubleshooting” section regarding common operating errors before concluding that the speakers are faulty.
13. **Secure placement or installation is the owner’s responsibility. Yamaha is not liable for accidents caused by improper placement or installation of speakers.**
4. Super-bass sound reproduced by this unit may cause a turntable to generate audio feedback. In this case, move the unit away from the turntable.
5. This unit may be damaged if certain sounds are continuously output at high volume level. For example, if 20 Hz–50 Hz sine waves from a test disc or bass sounds from an electronic instrument, etc. are continuously output, or if a turntable stylus touches the surface of a disc, reduce the volume level to prevent the unit from being damaged.
6. If you hear distorted noise (i.e., unnatural, intermittent “rapping” or “hammering” sounds) from this unit, reduce the volume level. Extremely loud movie soundtrack low frequency, bass-heavy sounds, or similarly loud popular music passages can damage this unit.
7. Vibration generated by super-bass sound may distort images on a TV. In this case, move the unit away from the TV set.

For NS-SWP20

1. Do not operate this unit upside down. It may overheat, possibly causing damage.
2. Never put a hand or a foreign object into the port located on the right side of this unit. When moving this unit, do not hold the port, as it might cause personal injury and/or damage to this unit.
3. When using a humidifier, be sure to avoid condensation inside this unit by allowing enough space around the unit and avoiding excess humidification. Condensation might cause fire, damage to the unit, and/or electric shock.

Contents

Package contents.....	1	Method of connection.....	3
Installation	1	Connection diagram.....	3
Installing the front, center, and surround speakers	2	Connecting the power cables	4
Installing the subwoofer.....	2	Troubleshooting.....	4
Wall-mounting the speakers.....	2	Specifications.....	4

Package contents

Make sure the package contains the following items.

Front and surround speakers (NS-B20) x4

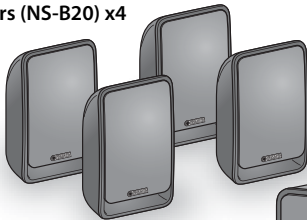

Subwoofer (NS-SWP20) x1

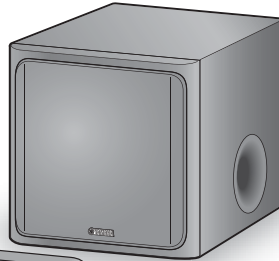

Center speaker (NS-C20) x1

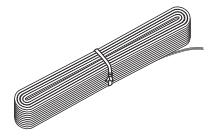

Speaker cable 25 m (82 ft.) x1
(To be cut into 6 lengths for the front, center, and surround speakers and a subwoofer. Take care to prevent injury when preparing the cables.)

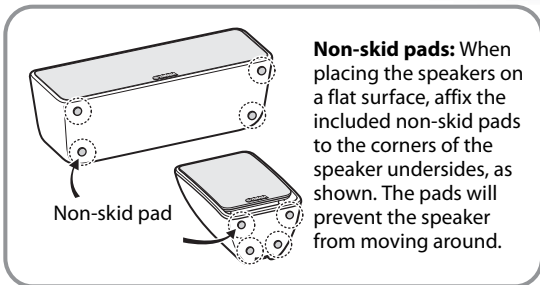

Non-skid pads (24 pcs.) x1
(For the front, center and surround speakers. Including 4 spare non-skid pads.)

Installation

Before you connect the speakers and subwoofer, place them in its respective location. This positioning is very important as it affects the overall sound quality of the system. Place the speakers in locations that will optimize the sound quality at your listening position. Refer to the illustration.

The position of the subwoofer is not as critical as the position of the other speakers because sub-bass sounds are not very directional. Refer to “Installing the subwoofer” on page 2 for more information.

Note

- Placing the speakers too close to a CRT-type TV may impair the picture color or cause a buzzing noise. In this case, move the speakers at least 20 cm (8”) away from the TV. This is not an issue with LCD and plasma TVs.

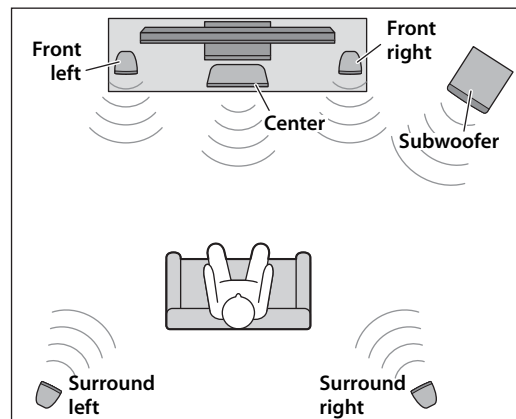

Installing the front, center, and surround speakers

Front speakers: Place the two front speakers on the left and right sides of the TV facing directly forward.

Surround speakers: Place the left and right surround speakers behind your listening position, facing slightly inward.

The front and surround speakers can be placed on a flat surface or wall-mounted.

See “Wall-mounting the speakers” for more information.

Center speaker: Place the center speaker centrally between the front speakers, facing directly forward.

Installing the subwoofer

Place the subwoofer on the outside of either the right or the left front speaker, as shown in **A** and **B**.

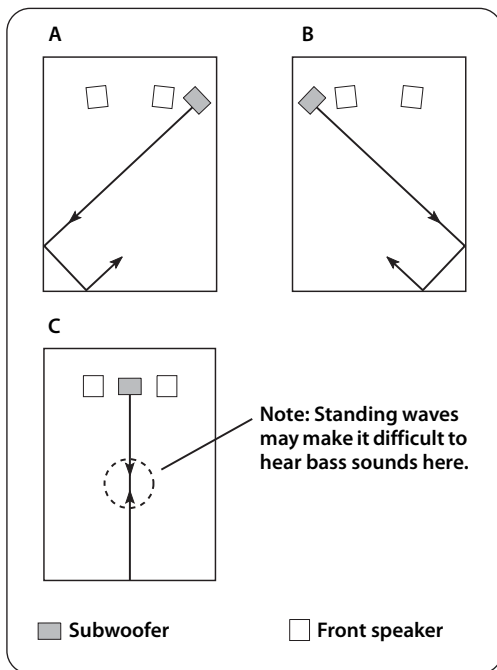

The placement shown in **C** is also possible, however, if the subwoofer is placed directly facing a wall and your listening position is in the center of the room, you may not be able to obtain enough bass sound from the subwoofer. This is because “standing waves” are forming between the two parallel walls and cancelling out the bass sounds. In this case, position the subwoofer at an angle to the wall. It may be necessary to break up parallel wall surfaces by placing bookshelves, etc., along them.

Wall-mounting the speakers

You can mount the speakers on the wall as follows.

- 1** Install screws into a solid wall or wall support as shown below. Use 3.5 to 4 mm (1/8") diameter self-tapping screws.
- 2** Hang each speaker by its keyhole slots onto the protruding screws.

Note

- Make sure the shaft of the screw is seated in the narrow part of the keyhole slot. Otherwise, the speaker may fall.

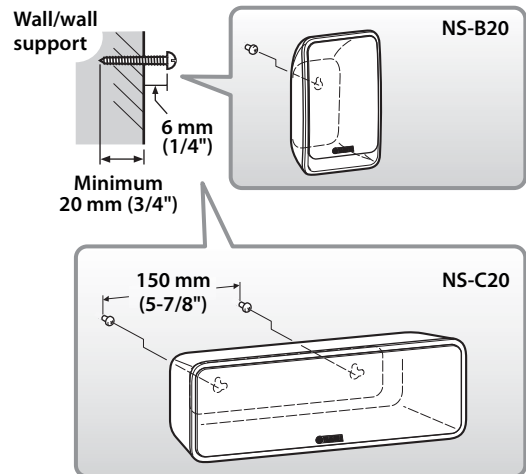

Warnings

- NS-B20 speaker weighs 0.48kg (1.06 lbs.) and NS-C20 speaker weighs 0.68 kg (1.50 lbs.). Do not mount the speakers on thin plywood or on a wall with a soft surface material. Otherwise, the screws may pull out of the surface and the speakers may fall, possibly damaging the speakers or causing personal injury.
- Do not affix the speakers to a wall using nails, adhesives, or unstable hardware. Long-term use and vibration may cause the speakers to fall.
- To avoid accidents resulting from tripping over loose speaker cables, affix the cables to the wall.
- Mount the speakers in a wall location that will be unlikely to result in injury to an individual's head.

Method of connection

Caution: Disconnect all components from AC outlets before proceeding.

Connection diagram

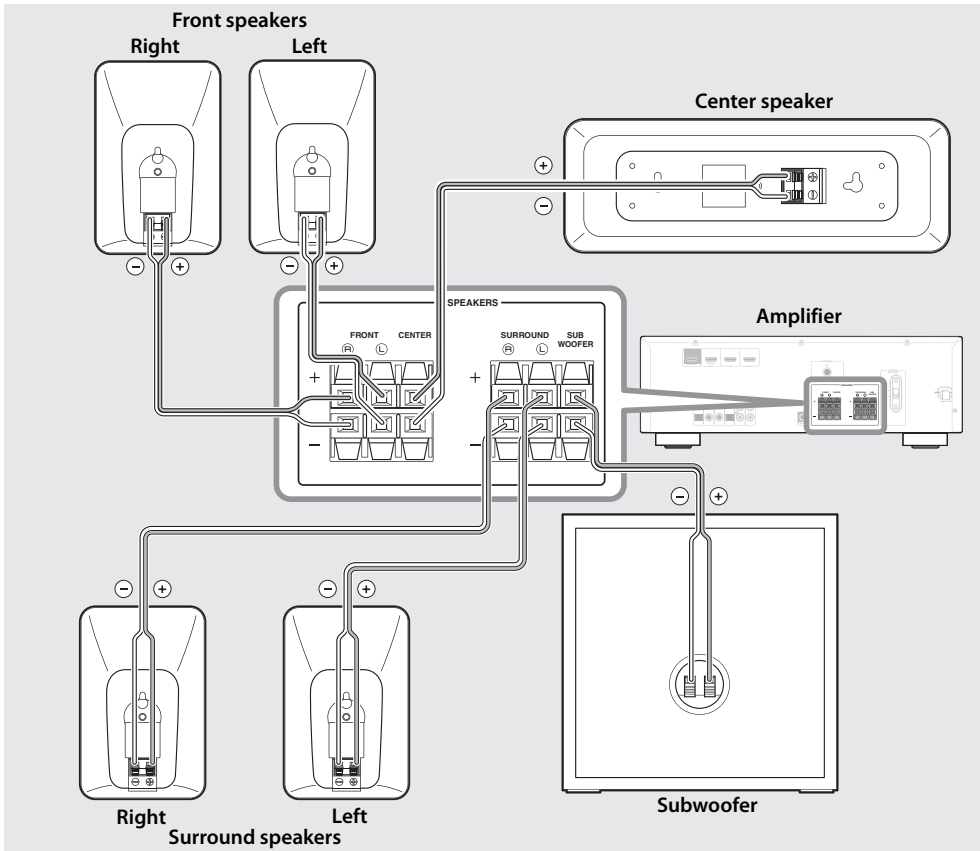

■ Preparing the speaker cables

- 1** Cut the included speaker cable to suitable lengths for the front, center, and surround speakers and a subwoofer. You need six cables.
- 2** Remove about 10 mm (3/8") of insulation from the end of each speaker cable.
- 3** Twist the bare wires tightly so the individual strands are not splayed.

10 mm (3/8")

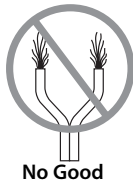
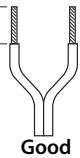

Notes

- Make the speaker cables as short as possible. Do not bundle or roll up excess cable.
- Be careful not to injure yourself while preparing the speaker cables.

■ Operating the speaker terminals

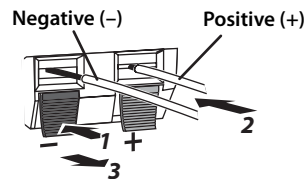

- 1** Press and hold the terminal tab.
- 2** Insert the bare wire.
- 3** Release the tab so that it closes securely on the bare wire, not the insulation.
- 4** Test the security of the connection by pulling gently on the cable.

Notes

- Make sure the bare wires do not touch each other, as this could damage the speaker or the amplifier.
- If the connections are faulty, you will hear no sound from the speakers.

■ Connecting the speakers and subwoofer

Connect each speaker and a subwoofer to the appropriate speaker terminals on your amplifier by using the cables you prepared earlier. See the “Connection diagram” on page 3 for reference.

Make sure you connect the speakers and subwoofer with the correct polarity—positive (+) terminals to positive (+) terminals, and negative (-) terminals to negative (-) terminals. If you get them crossed over, the sound will be unnatural and lack bass.

In your AV receiver’s speaker size settings, specify small (or “S”) for all of the speakers and subwoofer.

Connecting the power cables

Once you’ve completed all of the speaker and subwoofer connections, plug the amplifier, and your other AV components into suitable AC wall outlets.

Troubleshooting

If this product doesn’t work as expected, look for a possible cause below. If the issue you are experiencing is not listed, or you cannot resolve it after reading through these instructions, disconnect the power cable and contact an authorized Yamaha dealer or service center.

Issue	Possible cause	Remedy
There’s no sound.	The speaker cables are not connected properly.	Make sure the speaker cables are connected properly.
	The VOLUME control is set to 0.	Turn up the VOLUME control.
The sound is very quiet.	The speaker cables are not connected properly.	Make sure the speaker cables are connected properly: L (left) to L, R (right) to R, “+” to “+” and “-” to “-”.
The subwoofer is too quiet.	The source material doesn’t contain much bass.	Try playing source material that contains more bass.
	Bass sounds are being cancelled out by standing waves.	Reposition the subwoofer, or break up parallel wall surfaces by placing bookshelves or other large objects along the wall.

Specifications

■ Front, surround speakers (NS-B20) and center speaker (NS-C20)

Type	Full range acoustic suspension non magnetic shielding type
Driver	7 cm (2-3/4") cone type
Nominal input power	30 W
Maximum input power	100 W
Impedance	6 Ω
Frequency response	
NS-B20	70 Hz-25 kHz (-10 dB) -45 kHz (-30 dB)
NS-C20	65 Hz-25 kHz (-10 dB) -45 kHz (-30 dB)
Sensitivity	
NS-B20	83 dB/2.83 V, 1 m
NS-C20	84 dB/2.83 V, 1 m
Dimensions (W x H x D)	
NS-B20	115 x 176 x 88 mm (4-1/2" x 6-7/8" x 3-1/2")
NS-C20	291 x 101 x 103 mm (11-1/2" x 4" x 4")
Weight	
NS-B20	0.48 kg (1.06 lbs.)
NS-C20	0.68 kg (1.50 lbs.)

■ Subwoofer (NS-SWP20)

Type	Bass reflex non magnetic shielding type
Driver	16 cm (6-1/2") cone type
Nominal input power	30 W
Maximum input power	100 W
Impedance	6 Ω
Frequency response	30 Hz-2 kHz (-10 dB) -9 kHz (-30 dB)
Sensitivity	86 dB/2.83 V, 1 m
Dimensions (W x H x D)	262 x 264 x 287 mm (10-3/8" x 10-3/8" x 11-1/4")
Weight	5.2 kg (11.5 lbs.)

Specifications are subject to change without notice.

