

*Media Controller*

***YMC-700***

***neoHD***  
WiFi

***YMC-500***

***neoHD***

# Contents

## IMPORTANT

Before installing this unit, be sure to read the supplied Quick Start Guide.

## INTRODUCTION

<b>Features</b> .....	2
Notices .....	3
Supplied accessories .....	3
<b>Controls and functions</b> .....	4
Front/side/top panel .....	4
Remote control .....	5

## SETUP

<b>Connections</b> .....	6
<b>Remote control connection</b> .....	8
<b>Placing speakers</b> .....	9
<b>Initial Setup</b> .....	10
Before starting the Initial Setup .....	10
Step 1: Auto Speaker Setup .....	10
Step 2: TV Remote Control Setup .....	13
Step 3: Source Device Setup .....	14

## BASIC OPERATION

<b>General operation</b> .....	18
Screens and operation .....	18
Basic playback operation .....	19
Regular pop up menu items .....	19
<b>Enjoying the contents on an external devices</b> ....	20
Watching/listening to the source content .....	20
Using the remote control to operate external devices from the playback screen .....	21
Using virtual remote control to operate external devices .....	21
<b>Listening to FM Radio</b> .....	22
Automatic station preset .....	23
Recalling a preset station .....	23
Frequency tuning .....	23
Editing the station preset list .....	23
<b>Listening to music stored on your PC (YMC-700 only) or USB device</b> .....	24
Before enjoying the contents on your PC (YMC-700 only) .....	25
Playing music files .....	25
Repeat play and shuffle play .....	25

<b>Viewing photos stored on your PC (YMC-700 only) or USB device</b> .....	26
Viewing photos .....	27
Slide show .....	27
Shuffle browsing .....	27
Using the photos as a screen saver .....	27
<b>Enjoying contents stored on your iPod</b> .....	28
Listening to music contents .....	29
Watching video contents .....	29
Repeat play and shuffle play .....	29
<b>Listening to Internet Radio (YMC-700 only)</b> .....	30
<b>Listening to the Rhapsody® service (YMC-700 only)</b> .....	32
Useful functions .....	33
<b>Enjoying Bluetooth™ components</b> .....	35
Pairing .....	35

## ADVANCED OPERATION

<b>Setup menu</b> .....	36
Setup menu tree .....	36
Initial Setup .....	37
Speaker menu .....	37
Sound menu .....	38
Input menu .....	39
Network menu (YMC-700 only) .....	40
Rhapsody® Information menu (YMC-700 only) .....	41
Remote Control menu .....	42
Option menu .....	43
Signal Information .....	44
Update menu .....	44

## ADDITIONAL INFORMATION

<b>Troubleshooting</b> .....	45
<b>Glossary</b> .....	51
Information on audio/video jacks and cable plugs .....	53
Information on HDMI™ .....	54
<b>Specifications</b> .....	55
<b>Quick reference</b> .....	56

INTRODUCTION

SETUP

BASIC OPERATION

ADVANCED OPERATION

ADDITIONAL INFORMATION

## ■ About this manual

- This manual describes how to operate this unit using a remote control. Most operations are also available using the buttons on the top panel.
- ✎: indicates a tip for your operation.
- Notes contain important information about safety and operating instructions.
- This manual is printed prior to production. Design and specifications are subject to change in part as a result of improvements, etc. In case of differences between the manual and the product, the product has priority.

# Features

Thank you for your purchasing a Yamaha neoHD. The neoHD can control all of your devices through a simplified remote control unit and stylish/intuitive graphical user interface. Enjoy the Yamaha neoHD experience.

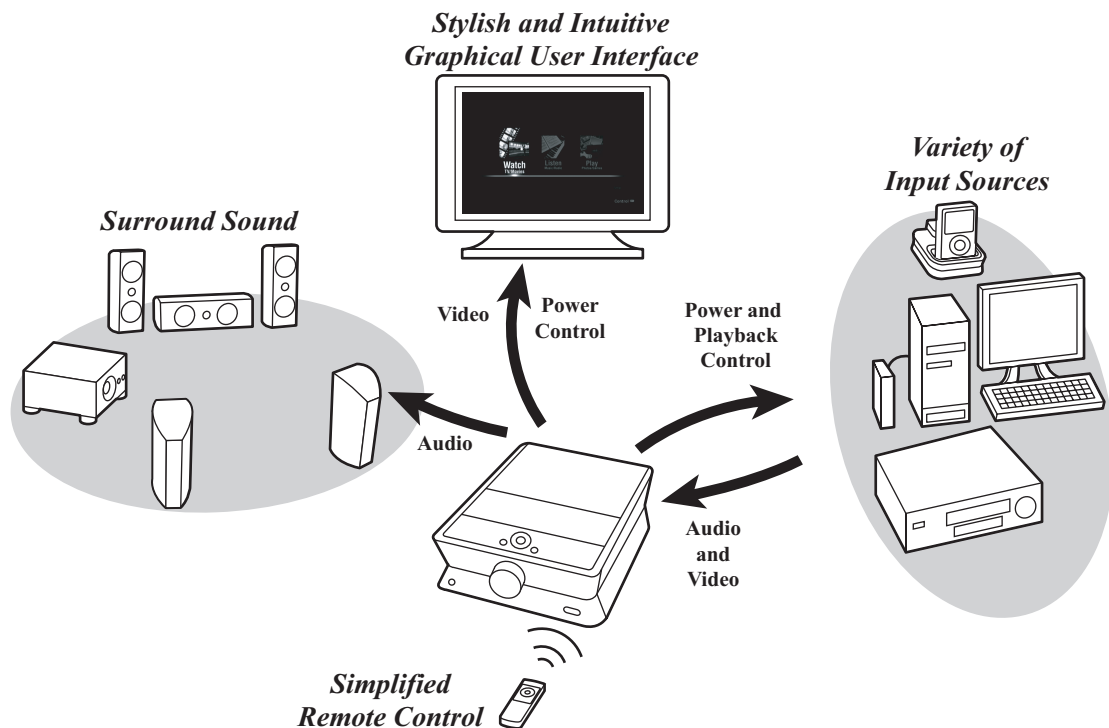

## Easy and intuitive operation

- ◆ Sophisticated graphical user interface
- ◆ Power control of connected TV and audio/video components
- ◆ Physical and virtual remote control to control playback of connected audio/video components

## Audio features

- ◆ Decoding and mixing of multi-channel sources (up to 7.1-channel input and 5.1-channel output)
- ◆ Proprietary Yamaha technology for the creation of sound fields (DSP Program)
- ◆ AIR SURROUND XTREME for 2.1-channel speaker layout
- ◆ Compressed Music Enhancer mode
- ◆ YPAO (Yamaha Parametric room Acoustic Optimizer) technology for Auto Speaker Setup
- ◆ Adaptive Dynamic Range Controlling to improve listenability at low volumes

## HDMI™ (High-Definition Multimedia Interface)

- ◆ HDMI interface for standard, enhanced or high-definition video as well as multi-channel digital audio based on HDMI version 1.3a (HDMI is licensed by HDMI Licensing, LLC.)
  - Automatic audio and video synchronization (lip sync) information capability
  - Deep Color video signal (30/36 bit) transmission capability
  - “x.v.Color” video signal transmission capability
  - High resolution video signal capability
  - High definition digital audio format signal capability
- ◆ HDCP (High-bandwidth Digital Content Protection System) licensed by Digital Content Protection, LLC.
- ◆ Analog to HDMI video up conversion

## Digital audio decoders

- ◆ Dolby TrueHD, Dolby Digital Plus, Dolby Digital decoder
- ◆ DTS 96/24, DTS decoder

## Radio tuner

- ◆ FM tuning capability, 40-station preset tuning

## DOCK terminal

- ◆ DOCK terminal to connect a Yamaha iPod universal dock (such as the YDS-11, sold separately) or Bluetooth wireless audio receiver (such as the YBA-10, sold separately)

## Network (YMC-700 only) and USB features

- ◆ NETWORK port and Wi-Fi to connect a PC or access Internet Radio and Rhapsody® via LAN
- ◆ DHCP automatic or manual network configuration
- ◆ USB port to connect a USB storage device (not including USB hard disk drives)

## Notes

- This unit supports USB mass storage class devices (FAT 16 or FAT 32 format).
- This unit supports audio files in following format: WAV (PCM format only), MP3, WMA, MPEG-4 AAC, and FLAC.
- For FLAC, the unit only supports bit lengths of 16 bits. Frequencies of up to 48 kHz are supported.
- This unit supports image files in the JPEG format.

## Notices



Manufactured under license from Dolby Laboratories. Dolby, Pro Logic and the double-D symbol are trademarks of Dolby Laboratories.



Manufactured under license under U.S. Patent #'s: 5,451,942; 5,956,674; 5,974,380; 5,978,762; 6,226,616; 6,487,535 & other U.S. and worldwide patents issued & pending. DTS and DTS Digital Surround are registered trademarks and the DTS logos, Symbol and DTS 96/24 are trademarks of DTS, Inc. © 1996-2008 DTS, Inc. All Rights Reserved.

### iPod™

“iPod” is a trademark of Apple Inc., registered in the U.S. and other countries.



**Fraunhofer** Institut Integrierte Schaltungen

MPEG Layer-3 audio coding technology licensed from Fraunhofer IIS and Thomson.

### HDMI

“HDMI”, the “HDMI” logo and “High-Definition Multimedia Interface” are trademarks, or registered trademarks of HDMI Licensing LLC.

### x.v.Color™

“x.v.Color” is a trademark of Sony Corporation.



Rhapsody and the Rhapsody logo are registered trademarks of RealNetworks, Inc.



The Wi-Fi CERTIFIED Logo is a certification mark of the Wi-Fi Alliance.

Windows XP, Windows Vista, Windows Media Audio, Windows Media Connect and Windows Media Player are either registered trademarks or trademarks of Microsoft corporation in the United States and/or other countries.

This product is manufactured under license from Allegro Software Development Corporation. ©1996-2008 Allegro Software Development Corporation. All rights reserved.

## Supplied accessories

Check that you received all of the following accessories.

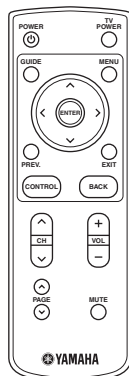

**Remote control**  
(P. 5)

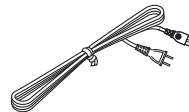

**Power cable**  
(P. 6)

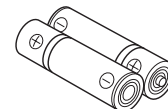

**Battery (AAA, LR03) x2**  
(P. 5)

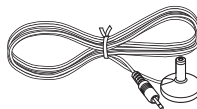

**YPAO Microphone (YPAO Mic)**  
(P. 11)

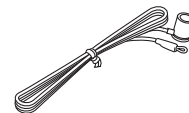

**Indoor FM antenna**  
(P. 7)

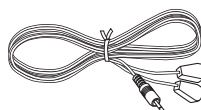

**IR flasher (3 m) x2**  
(P. 8)

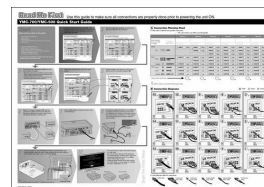

**Quick Start Guide**  
(P. 14)

**IMPORTANT**  
Before installing this unit, be sure to read the Quick Start Guide.

# Controls and functions

## Front/side/top panel

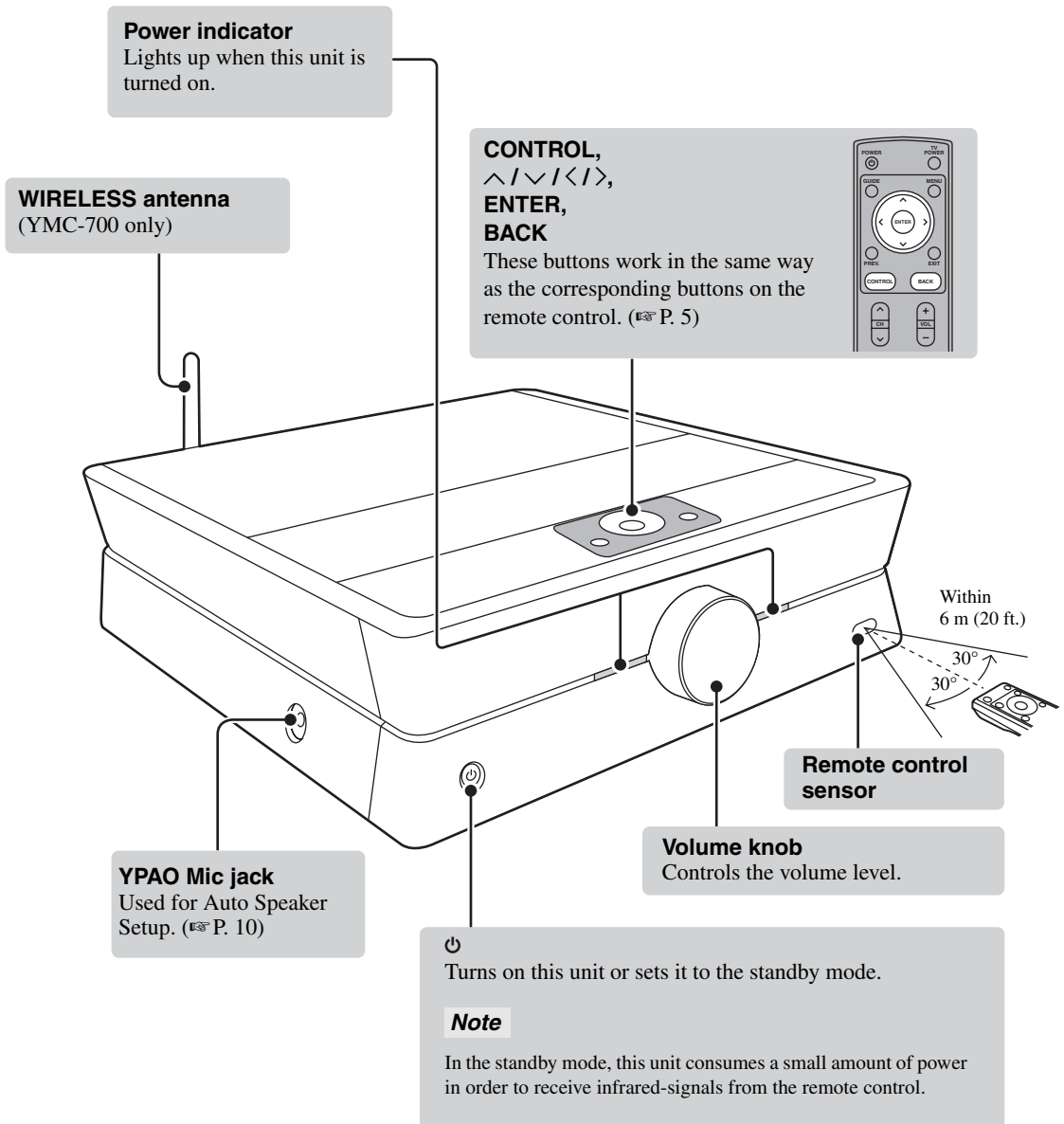



## Remote control

### IMPORTANT

- To control TV and source components, you need to make remote control connections (P. 8) and set the remote control code (P. 13, 14).
  - To control a TV or source component, aim the remote control at the remote control sensor of this unit.
- Operating instructions for activities* (P. 18-35)

#### POWER

Turns on this unit or sets it to the standby mode. (P. 19, 43)

- MENU
- GUIDE
- EXIT
- PREV.
- CH  / 

These buttons work differently depending on the currently selected source component. (P. 21)

#### PAGE /

##### When the playback screen is displayed

These buttons work differently depending on the currently selected source component. (P. 21)

##### When the virtual remote control or contents list is displayed

These buttons scroll up/down the virtual remote control or contents list.

#### MUTE



Mutes the audio output of this unit.

#### TV POWER

Turns on the TV or sets it to the standby mode individually while this unit is turned on.

#### </>///ENTER

##### When the GUI screen or the virtual remote control is displayed

Move the highlight with </>// and select it with ENTER.

##### When the playback screen is displayed

These buttons work differently depending on the currently selected source component. (P. 21)

#### BACK

Returns to the previous menu level. Press and hold to return to the top menu level.

#### CONTROL

Turns on or off the pop up menu and virtual remote control. Press and hold to return to the top menu level. Turns on this unit. (P. 43)

#### VOL +/-

Controls the volume level of this unit.

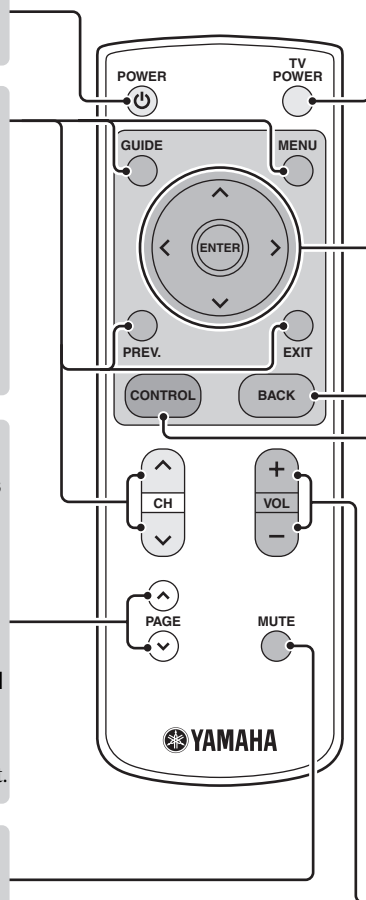

## ■ Installing batteries in the remote control

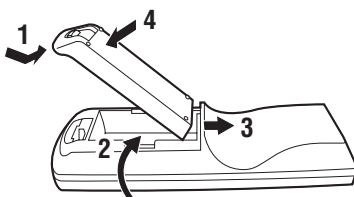

#### Batteries (supplied)

Make sure you insert the batteries as indicated by the polarity markings (+ and -).

### Notes

- Do not use an old battery together with a new one.
- Do not use different types of batteries (for example, alkaline and manganese) together.
- If the batteries run out, immediately remove them from the remote control to prevent an explosion or acid leak.
- Dispose of the batteries according to the regional regulations.
- If a battery starts leaking, dispose of it immediately. Be careful not to let leaking battery acid come into contact with your skin or clothing. Before inserting new batteries, wipe the compartment clean.

# Connections



Make sure that this unit and other components are unplugged from the AC wall outlets.

## Remote control

Connect the supplied IR flashers to the REMOTE CONTROL OUT 1 and 2 jacks.

You can attach the IR flashers to any of the components used in conjunction with this unit because the same signal is output from the REMOTE CONTROL OUT 1, 2, and 3 jacks.

☞ P. 8

IR flashers (supplied)

## USB storage device

Be sure to insert in the proper direction.

You can connect or disconnect USB storage devices while this unit is turned on.

Supported devices  
☞ P. 2

## Wired network YMC-700 only

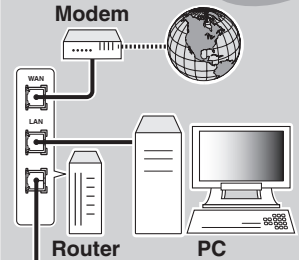

Setup ☞ P. 25, 40

Use CAT-5 or higher STP cable

## Power cable

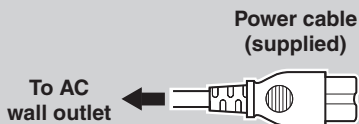

Power cable (supplied)

## Speakers and Subwoofer

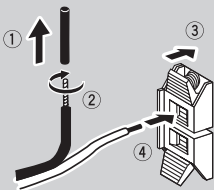

Speaker layout ☞ P. 9

Also refer to the supplied Quick Start Guide.

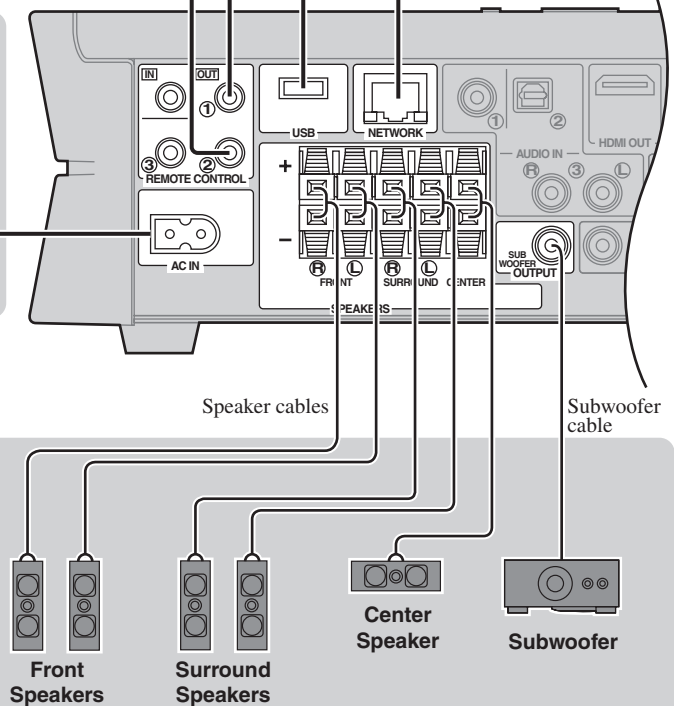

### Caution

- Be sure to use speakers with 6 ohm or higher impedance.
- Do not let the bare speaker wires touch each other or do not let them touch any metal part of this unit. This could damage this unit and/or speakers.
- Be sure to connect the left channel (L), right channel (R), “+” and “-” properly. If the connections are faulty, this unit cannot reproduce the input sources accurately.
- If speakers have color coded terminals, match the color. If not, connect the striped (grooved, etc.) cable to the “+” terminals of this unit and your speaker and connect the plain cable to the “-” terminals.

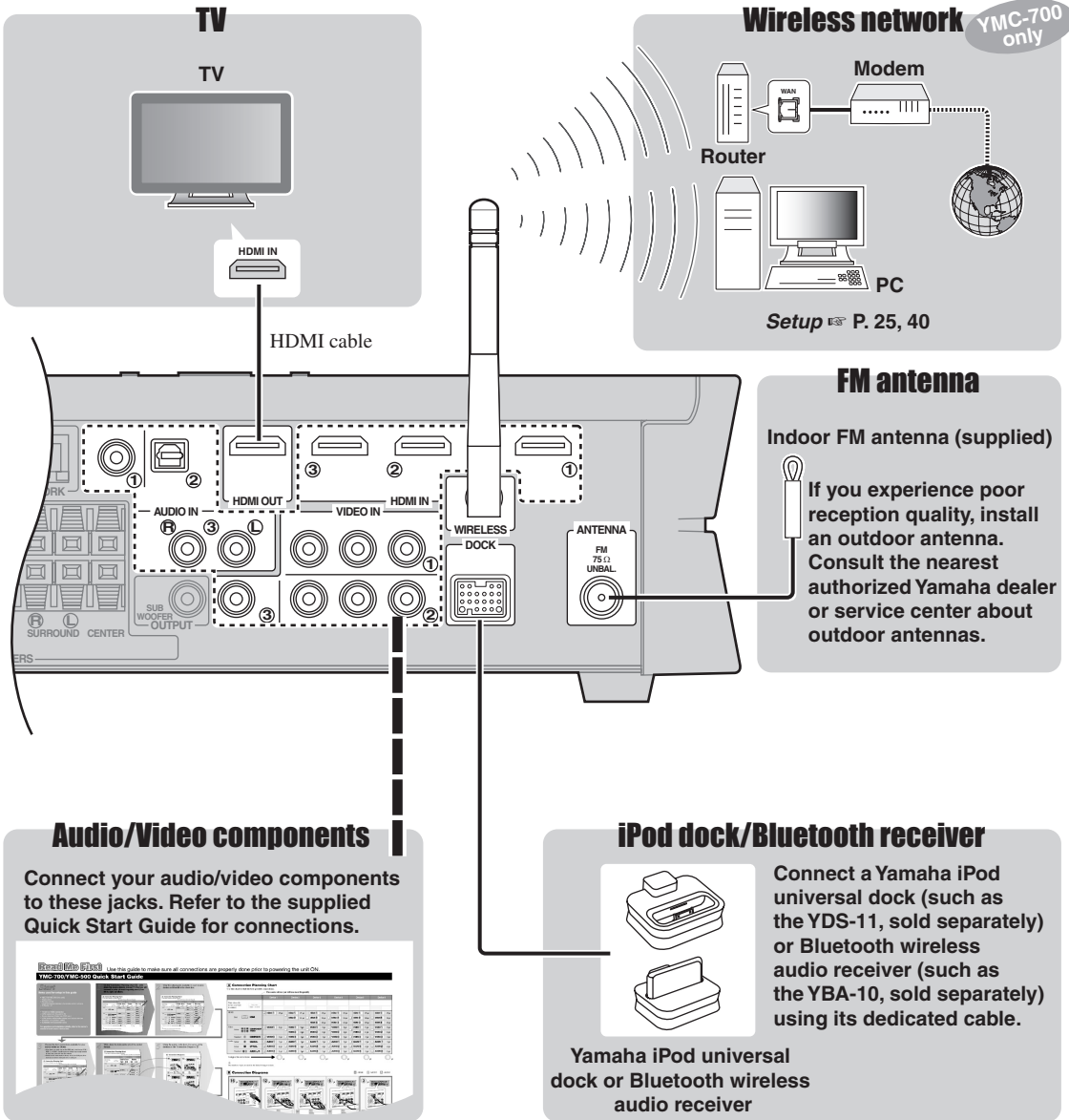

**TV**

TV



HDMI cable

**Wireless network**

YMC-700 only

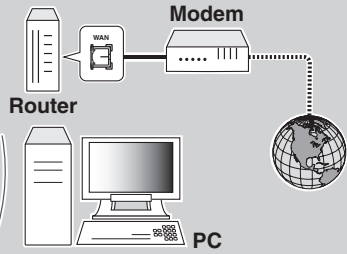

Setup P. 25, 40

**FM antenna**

Indoor FM antenna (supplied)

If you experience poor reception quality, install an outdoor antenna. Consult the nearest authorized Yamaha dealer or service center about outdoor antennas.

**Audio/Video components**

Connect your audio/video components to these jacks. Refer to the supplied Quick Start Guide for connections.

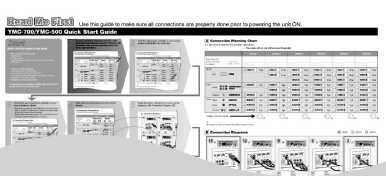

**iPod dock/Bluetooth receiver**

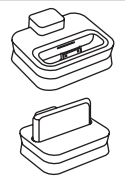

Connect a Yamaha iPod universal dock (such as the YDS-11, sold separately) or Bluetooth wireless audio receiver (such as the YBA-10, sold separately) using its dedicated cable.

Yamaha iPod universal dock or Bluetooth wireless audio receiver



# Remote control connections

You can control your TV and the components connected to this unit using the remote control of this unit by connecting the IR flashers between this unit and the components, and by setting the IR codes. You can also turn on or off the TV and the components in conjunction with the operation of this unit.

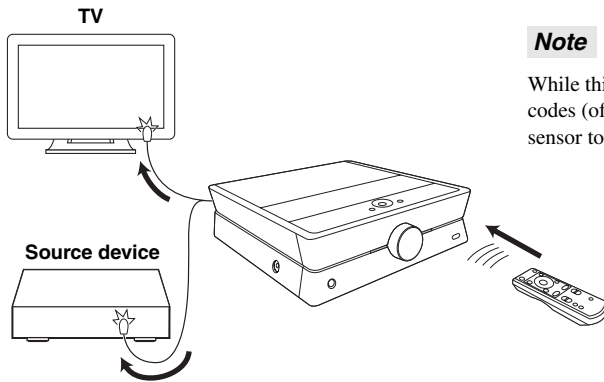

## Note

While this unit is turned on, this unit passes all remote control codes (of the TV and source devices) input at the remote control sensor to the TV and the devices via IR flashers.

## About the remote control codes

This unit equips built-in remote control codes for most functions of many audio/video components. The remote control codes can be “learned”, assigning them to the remote control of this unit or to the virtual remote control (P. 21). The unit transmits the proper codes to the different devices through the IR flasher.

## ■ Connections

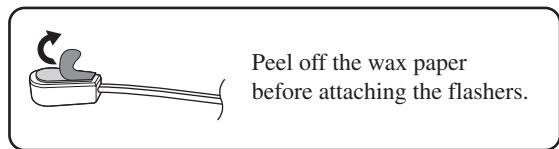
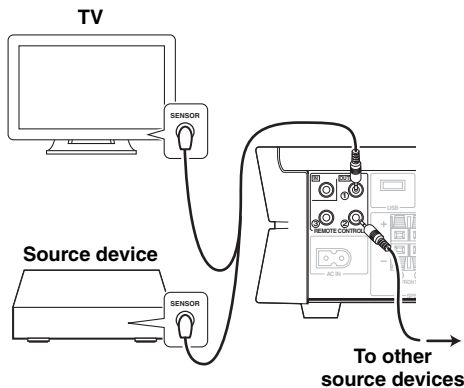

Connect the plugs of the supplied IR flashers to the REMOTE CONTROL OUT 1 and 2 jacks, and attach the flashers to the remote control sensors of your TV and the components connected to this unit. The supplied IR flashers have two flasher heads each. Both flasher heads function equivalently. You can also connect a commercially available flasher to the REMOTE CONTROL OUT 3 jack.



- You can connect the IR flashers to any of the REMOTE CONTROL OUT 1, 2, and 3 jacks because the same signal is output.
- Refer to the owner’s manual of the TV and source devices for the position of the remote control sensor.

## ■ Settings

### Make the following settings.

- The IR setting for your TV  
*Initial Setup* P. 10, *Setup Menu* P. 42
- The IR settings for the components connected to this unit  
*Initial Setup* P. 10, *Setup Menu* P. 39
- Other settings  
*“Initial Screen” menu* P. 43

## ■ Operations

To control the TV and the components connected to this unit, aim the remote control at the remote control sensor of this unit.

*Enjoying the contents on an external device* P. 20

### About the REMOTE CONTROL IN jack

You can connect a commercially available IR receiver to this jack to control this unit even if it is concealed. Place the IR receiver within sight.

# Placing speakers

The speaker layout below shows the speaker setting we recommend.

## ■ 5.1-channel speaker layout

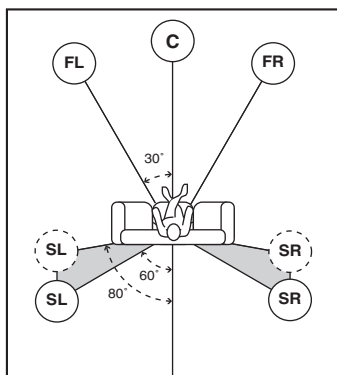

**FL:** Front left speaker  
**FR:** Front right speaker  
**C:** Center speaker  
**SR:** Surround right speaker  
**SL:** Surround left speaker  
**SW:** Subwoofer

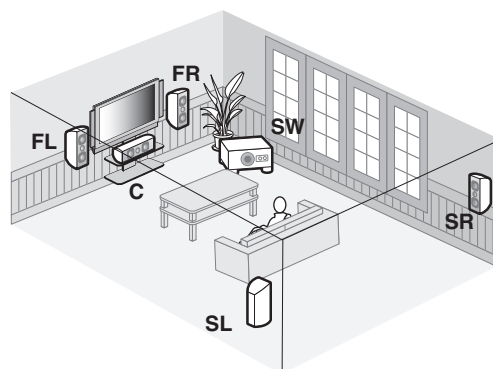

## ■ 2.1-channel speaker layout

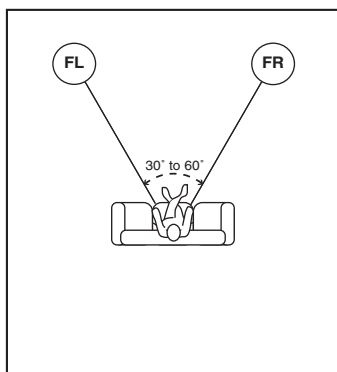

**FL:** Front left speaker  
**FR:** Front right speaker  
**SW:** Subwoofer

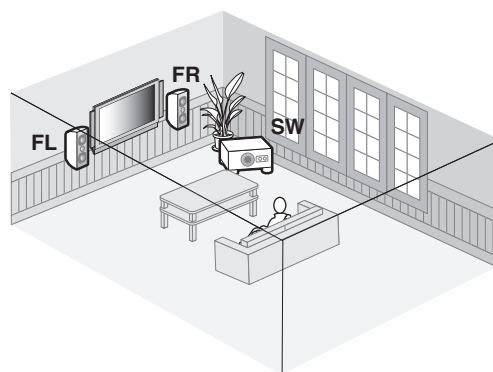

You can enjoy 2.1-channel playback using two front speakers and a subwoofer. Also, you can enjoy surround playback using the AIR SURROUND XTREME function of this unit (P. 38, 51).



### For other speaker combinations

You can enjoy multi-channel sources by using a speaker combination other than the 5.1-channel or 2.1-channel speaker combinations.

# Initial Setup

Once all the connections are finished, optimize this unit for your watching/listening/playing environment by using the “Initial Setup” menu.

## Step 1: Auto Speaker Setup



## Step 2: TV Remote Control Setup



## Step 3: Source Device Setup

### Before starting the Initial Setup

Make sure of the following check points.

- Speakers are connected appropriately.
- The IR flashers are correctly connected to this unit and attached to the connected components.
- The connected subwoofer is turned on and the volume level is set to about half way (or slightly less).
- The crossover frequency control of the connected subwoofer is set to the maximum.

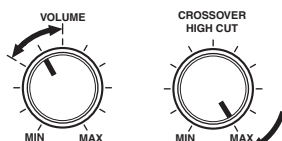

Controls of a subwoofer (example)

- The room is sufficiently quiet.

### Notes

- Be advised that it is normal for loud test tones to be output during the Auto Speaker Setup procedure.
- To achieve the best results, make sure the room is as quiet as possible while the Auto Speaker Setup procedure is in progress. If there is too much ambient noise, the results may not be satisfactory.

## Step 1: Auto Speaker Setup

Auto Speaker Setup (YPAO) uses unique technology to optimally calibrate the frequency response and level according to the speaker configuration, characteristics, and their distance.

- 1 Turn on the TV, then set the video input source selector of the TV to “HDMI 1” (etc.).**  
Refer to the owner’s manual of the TV for details.
- 2 Turn on the connected source devices and subwoofer.**
- 3 Press **POWER** to turn on this unit.**  
The “neoHD” logo mark appears, followed by the “Initial Setup” menu.

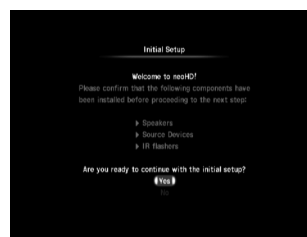

If the Initial Setup menu does not appear, check the following check points:

- Is the video input source selector of the TV set correctly?
- Is the TV connected to this unit correctly?
- Is the TV turned on?
- Is this unit connected to the AC wall outlet?

#### 4 Select “Yes” to start the initial setup procedure.

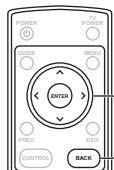

Use these buttons to operate during the Initial Setup procedure. (P. 5)

The following screen appears:

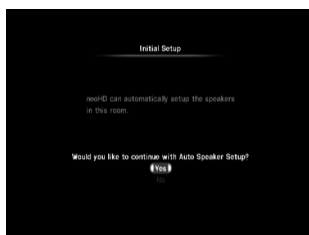

If you select “No”, the Initial Setup procedure will be skipped. You can perform it in Setup menu later. (P. 37)

#### 5 Select “Yes” to enter the Auto Speaker Setup menu.

Read the displayed message carefully.

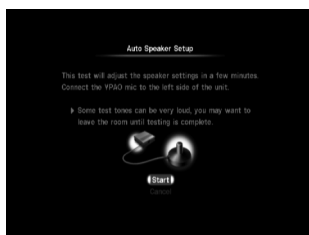

If you select “No”, the Auto Speaker Setup procedure will be skipped. You can perform it later. (P. 37)

#### 6 Connect the supplied YPAO Mic to the YPAO MIC jack.

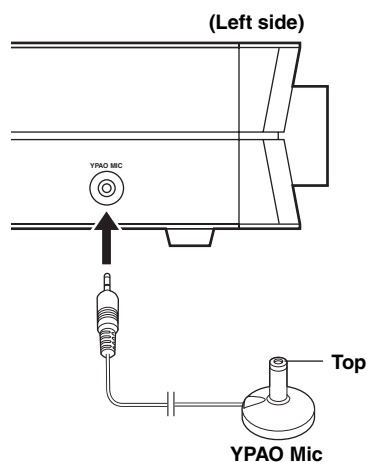

#### 7 Place the YPAO Mic at your normal listening position.



It is recommended that you use a tripod, the backrest of the sofa, etc. to affix the YPAO Mic at the same height as your ears would be when you are seated in your listening position. You can use the attached screw of a tripod (etc.) to fix the YPAO Mic to the tripod (etc.).

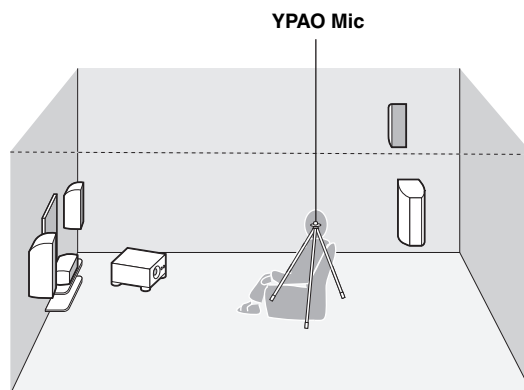

*Continued*

**Before proceeding to the next operation**

Once you perform the next operation, this unit starts the Auto Speaker Setup procedure in 10 seconds. During the Auto Speaker Setup procedure, do not perform any operation on this unit. For more accurate measurements, we recommend that you get out of the room or move to a wall away from any speakers in the meantime. It takes a few minutes.

**8 Select “Start” to start the measurement.**

This unit starts the count down for the measurement.

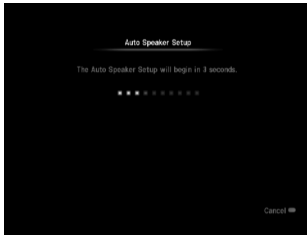

Loud test tones are output from each speaker during the measurement. Once all items are measured, the following screen appears:

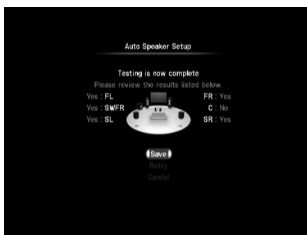

**Results (example)**

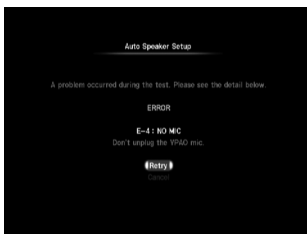
**If an error message (P. 50) appears**

**Error message (example)**

- Solve the problem (P. 50), then select “Retry” to retry the measurement.
- Select “Cancel” to cancel the setup process.

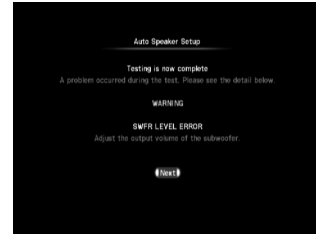
**If a warning message (P. 50) appears**

**Warning message (example)**

If the warning message “SWFR LEVEL ERROR” appears, the adjustments are made, but the adjustment may not be optimal. Select “Next” to continue the process.

**9 Check the status of each speaker, then select “Save” to proceed with the Initial Setup process.**

The speaker statuses are as follows:

- Yes:** Speaker is connected.
- No:** Speaker is not installed, or speaker cable is disconnected.
- Too Loud:** Subwoofer (SWFR) only. The level of the subwoofer is too high.
- Too Low:** Subwoofer (SWFR) only. The level of the subwoofer is too low.

If you are not satisfied with the result, check the speaker connections and/or subwoofer level, then select “Retry”.



If you want to proceed with the Initial Setup process without using the result of the measurements, select “Cancel”.

**10 Disconnect the YPAO Mic from this unit and select “OK”.**

The YPAO Mic is sensitive to heat. Keep it away from direct sunlight.

## Step 2: TV Remote Control Setup

By making the TV remote control settings, this unit will control the power of the TV in accordance with the power of this unit.

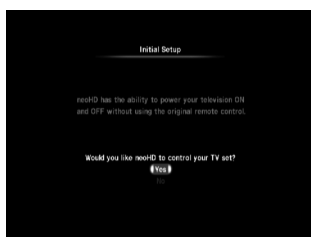

- 1 Select "Yes" to start the TV Remote Control Setup procedure.



If you select "No", the TV Remote Control Setup procedure will be skipped. You can perform it later. (P. 42)

- 2 Select the brand of the TV connected to this unit.

Press **CH**  $\wedge$  /  $\vee$  to skip through the brand list alphabetically.

Press **PAGE**  $\wedge$  /  $\vee$  to scroll the list page by page.



- 3 Select the TV remote control code.

When multiple remote control codes are displayed, select the first one. Registration confirmation appears.

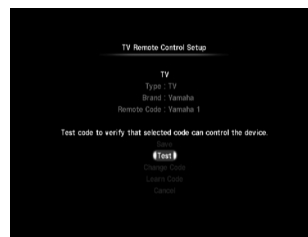

**Save:** Confirm the displayed setting.

**Test:** Perform the function test.

**Change Code:** Select another code.

**Learn Code:** Jump to the TV Remote Code Learning screen. (P. 42)

Select this if you want to program the remote control code manually.

**Cancel:** Skip the TV remote control settings. You can set them later. (P. 42)

- 4 Check the information, then select "Test".

The "TV Remote Code Test" screen appears.



- 5 Read the displayed information, then select "Start" to start the function test.

The following test screen appears:

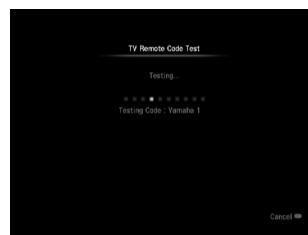

### Note

This unit tries to turn off/on the TV for test purposes.

*Continued*

**6 Check whether the TV turned on and off correctly.**



- To cancel the TV Remote Code Test procedure, press **BACK**.
- If the TV turns off during the test and does not turn back on after waiting over a minute, turn the TV on using the TV's remote control.

**7 When the following message appears, select "Yes" or "No - Try next code".**

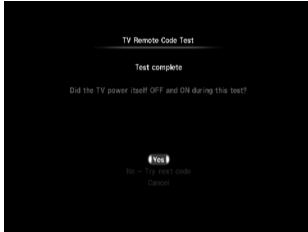

Select "Yes" to finish the TV Remote Code Test procedure or "No - Try next code" to check another remote control code. When you select "No - Try next code", the test mode of the other code starts immediately.

**Note**

This unit does not contain all possible codes for commercially available TVs. If this unit does not turn the TV off/on with the codes provided for that brand, select "Learn Code" to recall the TV Remote Code Learning screen (P. 42) and program the remote control code manually.

**8 Select "Save" to finish the TV remote control code setting and proceed with the Initial Setup process.**



When you want to set the TV remote control code again, select "Change Code".

**Step 3: Source Device Setup**



Prepare the [A] Connection Planning Chart of the Quick Setup Guide in advance.

In these instructions, the examples assume that the connections below are made.

Device 1		
<b>Cable box</b>		
Time W	CB-528	
<input checked="" type="checkbox"/>	HDMI ①	15 pt
<input checked="" type="checkbox"/>	VIDEO ①	9 pt
<input checked="" type="checkbox"/>	VIDEO ③	3 pt
<input checked="" type="checkbox"/>	AUDIO ①	3 pt
<input type="checkbox"/>	AUDIO ②	2 pt
<input checked="" type="checkbox"/>	AUDIO ③	1 pt

➔ 15 pt

## 1 Select "Yes" to start the input source device setting.

The "Source Device Setup" screen appears.



If you select "No", the Source Device Setup procedure will be skipped. You can perform it later. (P. 39)

## 2 Select the type of the device.

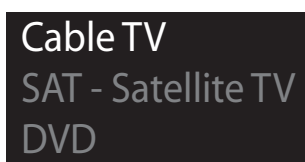
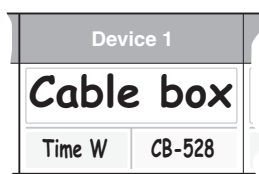

You can change the name of input source displayed in the source menu screen (P. 18) to the desired one later (P. 40).

## 3 Select the terminal to which the source component is connected.

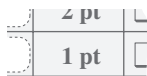

15 pt



HDMI 1 15 points

If you select "Game" in step 2, "Will you use this device to Watch Movies?" appears. Select "Yes" or "No" in accordance with the intended use.

If you select "DVD", "Blu-ray", or "Game" in step 2, "Will you use this device to Listen to CD's?" appears. Select "Yes" or "No" in accordance with the intended use.

## 4 Check the confirmation screen, then select "Yes".



The device type, connection method, and names of the input displayed in the Watch/Listen/Play source menu screens (P. 18) are shown.



When you want to change the setting, select "Retry".  
If you want to discard the setting, select "Cancel".

## 5 Select "Yes" to set the remote control code of the device.

The "Source Device Setup - Remote Control" screen appears.

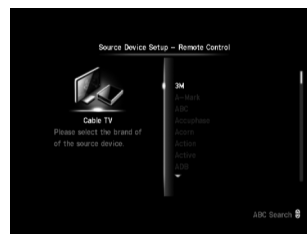

If you select "Other" in step 2, you need to select the type of the input source device. For example, select "Cable TV".



You can skip the remote control code settings and set them later. (P. 40)

## 6 Select the brand of the device.

Press **CH**  $\wedge$  /  $\vee$  to skip through the brand list alphabetically.

Press **PAGE**  $\wedge$  /  $\vee$  to scroll the list page by page.

## 7 Select the remote control code.

When the selected brand has multiple remote control codes, select the first one.

*Continued*



**8 Check the confirmation screen, then select “Test”.**

The following test screen appears:

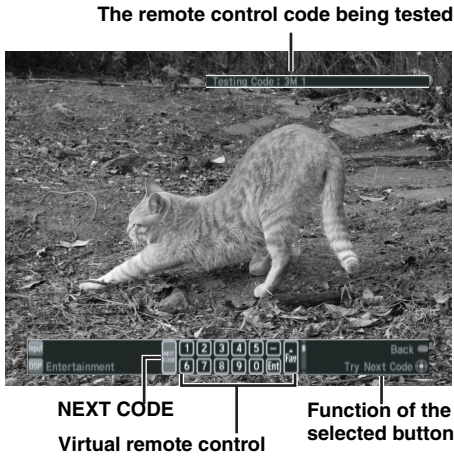

**9 Test some of the controls on the virtual remote control which is displayed on the screen to check whether the controls function correctly.**

^ / v / < / >: Moves the highlight.  
**ENTER**: Tests the function.

We recommend that you select some buttons besides “**⏻** (Power On/Off)” to test the function. If controls do not function properly, select “NEXT CODE” at the left edge of the virtual remote control. The remote control code switches and you can try the next remote control code. (Example: from Yamaha1 to Yamaha2)

**Note**

If the brand has only one set of remote control codes, “NEXT CODE” does not function.

**10 When you find the remote control code works (or not), press **BACK** on the remote control to return to the confirmation screen.**

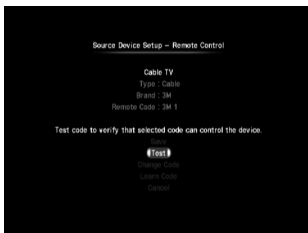

**11 When you find a proper remote control code, select “Save” to complete the registration.**



- If you want to discard the setting and make a new setting, select “Change Code”.
- If this unit does not control the device with any of the codes provided for the brand, select “Learn Code” to recall the Remote Code Learning screen (P. 40) and program the remote control code manually.

**12 Select “Yes” to register another input source device and repeat steps 2 to 11 until all devices listed in the Quick Start Guide are set.**



**13 Select “No” to complete the input source device registration.**

**14 Select the first screen to be displayed when you turn on this unit by pressing **POWER** or **CONTROL**.**

For example, you can set this unit to display the cable box (STB) screen when you turn on this unit by pressing **CONTROL**.

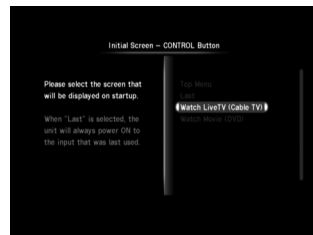
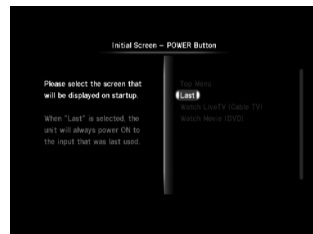

---

**15** Select “OK” to complete the Initial Setup procedure.



You can change the first screen to be displayed later.  
( P. 43)

# General operation

## Screens and operation

To control playback and make settings, operate the GUI (graphical user interface) screen displayed on the TV using the supplied remote control. In most cases, the screen changes as follows.

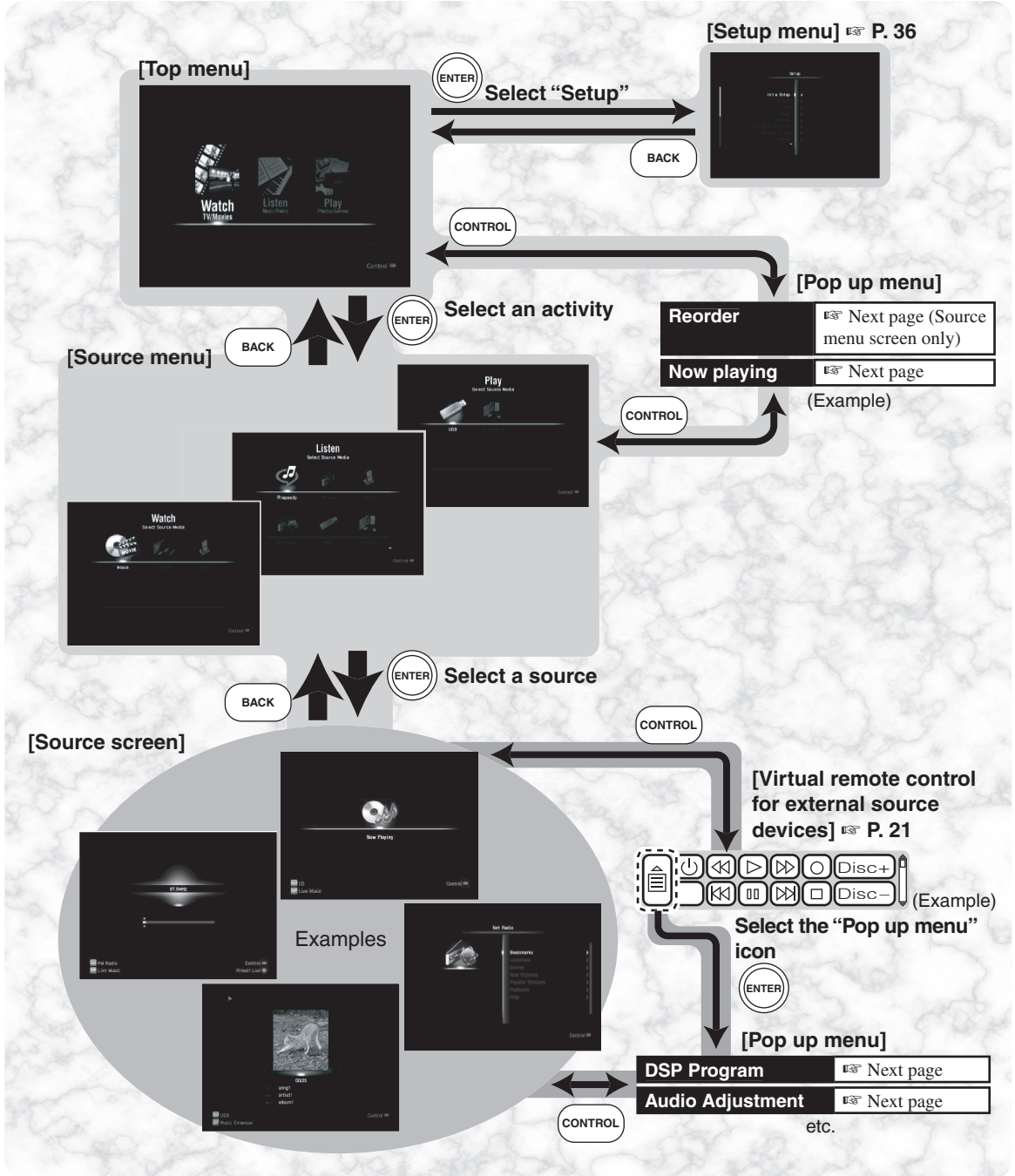

## Remote control operations for the GUI

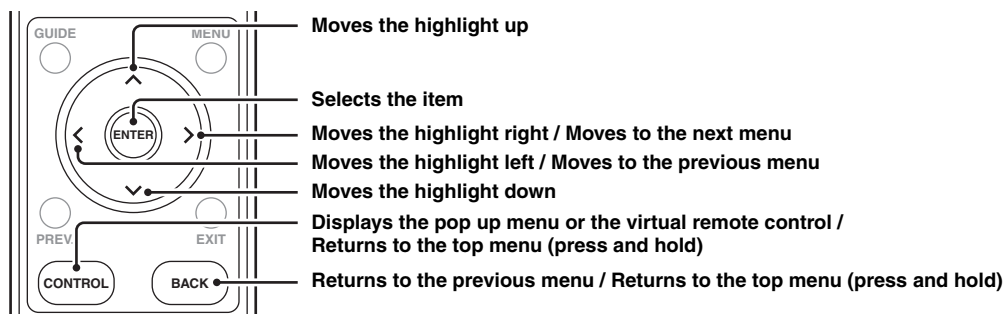

## Basic playback operation

- 1**

**Press POWER or CONTROL to turn on this unit.**

If you have finished the TV remote control setting and an IR flasher is connected/attached correctly, the TV turns on automatically. You can change the behavior of the TV power control function.  
*Connection* P. 8, *IR setting* P. 42, *TV Power Control* P. 42
- 2**

**Select an input source.**

Select an input source using the GUI screen on the TV. Refer to the previous page and the instructions above. The source component turns on automatically. You can change the behavior of the power control function.  
*Connection* P. 8, *IR settings* P. 40, *Source Power Control* P. 42
- 3**

**Start playback on the selected component.**

or

**Select a program or file to play back.**

You may need to make some settings before beginning playback.  
*Playback instructions* P. 22-35
- 4**

**Adjust the volume level.**

You can mute the sound by pressing MUTE.
- 5**

**Make various settings using the pop up menu.**

*Regular pop up menu items*  
 P. "Regular pop up menu items" on this page.  
*Pop up menu items provided for the different sources* P. 22-35
- 6**

**Press POWER to turn off this unit.**

If you have finished the remote control settings for the TV and components connected to this unit and IR flashers are connected/attached correctly, those components turn off automatically.



You can turn on/off the TV by pressing TV POWER.

## Regular pop up menu items

The following pop up menu items are available on the top menu, the source menu, or the playback screen for all sources:

### Now Playing

Select this menu to jump back to the playback screen of the source that is currently being played.

### Reorder

Select this menu to reorder the icons on the source menu screen. Move the icon using ^ / v / < / > then press ENTER.

### Audio Adjustment

Select this menu to adjust the sound settings (bass/treble/subwoofer level). Change the value using < / >.

Parameter	Value
Treble / Bass	-6 to +6
SWFR Level	-20 to +20

### DSP Program

Select this menu to select a DSP program.

DSP Program	Feature
Movie	For movie contents.
Entertainment	For TV programs, video games, etc.
Live Music	For music contents.
Music Enhancer	For compression artifacts (such as the MP3 format). This program enhances your listening experience by regenerating the missing harmonics in a compression artifact.
All Channel Stereo	To output stereo sound from all speakers.
Off	To enjoy unprocessed sound.



- You can select a DSP Program for each activity of each source individually so that you can easily recall the input sources together with your favorite DSP Program.
- The DSP program is turned "Off" when decoding Dolby TrueHD and Dolby Digital Plus sources, as well as PCM sources of over 96 kHz.

# Enjoying the contents on an external devices

By connecting external components (players/recorders, STBs, game consoles, etc.) to this unit, you can enjoy the contents played back on the components with rich surround sound. Also you can control the components with the remote control of this unit by connecting/attaching the IR flashers and making the remote control code settings.

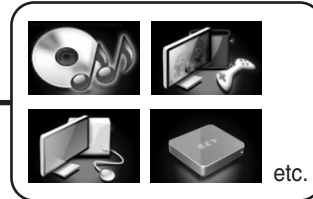
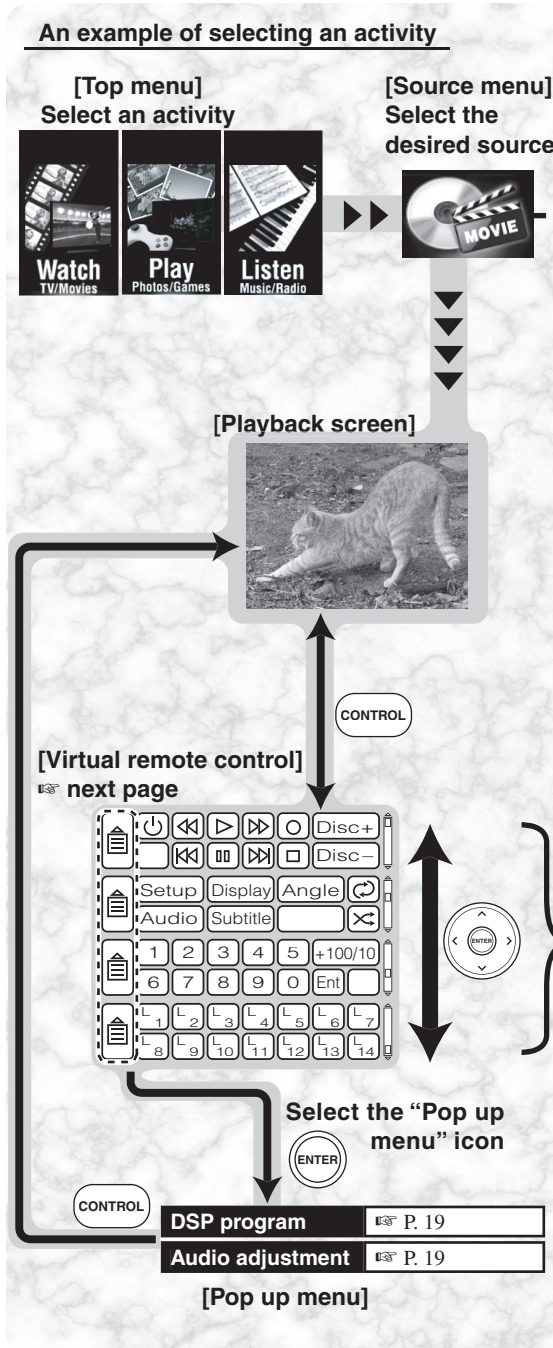

## Watching/listening to the source content

- 1 Select the desired source on the source menu screen.**  
The source device turns on automatically. You can change this setting. P. 42
- 2 Start playing back the content or desired TV program by using the supplied remote control or the virtual remote control.**

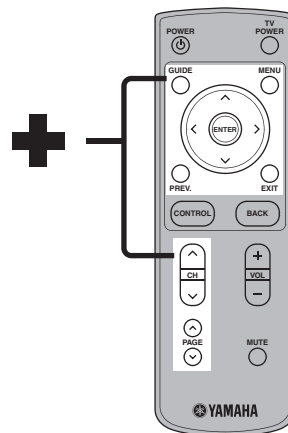

next page



- When the virtual remote control is not displayed, you can control the menu screen of the DVD, etc.
- If you do not use the IR flashers, control playback using the remote controls of the individual component.

## Using the remote control to operate external devices from the playback screen

While the playback screen is displayed, you can control the source component using the buttons shown below (☞ step 2 of the previous page). Aim the remote control at the remote control sensor of this unit. Make sure that you have finished the remote control settings for the component and an IR flasher is connected/attached correctly.

		Type of component you set in the setup menu							
		Blu-ray	DVD	DVR	Cable, Satellite/DSS	Other Video Component	Other Audio Component	Apple TV	CD
Button on the remote control	<b>GUIDE</b>	Top Menu		Guide				—	—
	<b>MENU</b>	Pop Up Menu	Disc Menu	Menu				—	—
	^	Menu Up							Stop
	v	Menu Down							Pause
	<	Menu Left					Skip Down		
	>	Menu Right					Skip Up		
	<b>ENTER</b>	Menu Select							
	<b>PREV.</b>	—	—	Last Channel	Last Channel	—	—	—	—
	<b>EXIT</b>	Return	Return	Exit	Exit	Back	Exit	—	—
	<b>CH ^</b>	Skip Up	Skip Up	Channel Up	Channel Up	Channel Up	Preset Up	—	Skip Up
	<b>CH v</b>	Skip Down	Skip Down	Channel Down	Channel Down	Channel Down	Preset Down	—	Skip Down
	<b>PAGE ^</b>	Sub Menu	Play		Page Up	Skip Up		—	Disc Up
	<b>PAGE v</b>	Pause		Page Down	Skip Down		—	—	Disc Down

- When the virtual remote control is displayed, the shaded buttons do not function as listed above, but control the virtual remote control.
- Some buttons may not work depending on the source device or the source contents.

## Using virtual remote control to operate external devices

You can control the components connected to this unit using the virtual remote control. The function of each button is displayed at the right bottom of the screen. Make sure that you have finished the remote control settings for the component and an IR flasher is connected/attached correctly.

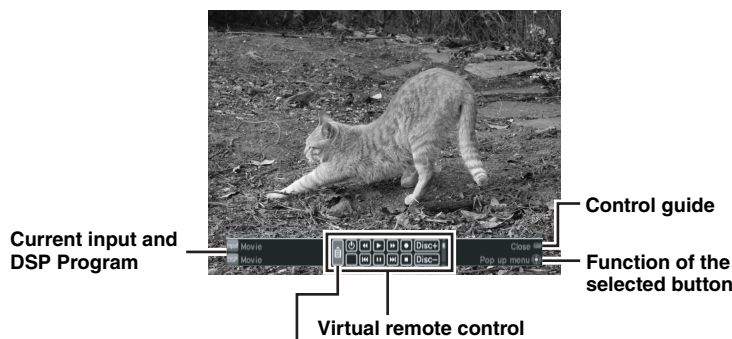

Select "[Pop up menu icon]" to open the pop up menu to control this unit.

Aim the remote control at the remote control sensor of this unit. Press ^ / v / < / > and **PAGE** ^ / v to select a button, then press **ENTER**.

### TV Favorite button (Fav)

This button is displayed when the type of the external component is "Cable", "Satellite/DSS", or "DVR". You can register your favorite TV stations and recall them easily. *TV Favorite* ☞ P. 42

### Exclusive learning buttons (L1-L14)

Use these exclusive learning buttons (L1-L14) on the virtual remote control to recall the programmed function of the other remote control. You can name the buttons freely. (☞ P. 40)



The displayed buttons vary depending on the type of the component being played back.

### Note

Some buttons may not work depending on the source device or the source contents.

# Listening to FM Radio

You can receive FM radio stations with this unit. To listen to FM radio stations, refer to the GUI screen and perform the operations explained on the next page. Connect the indoor FM antenna in advance.

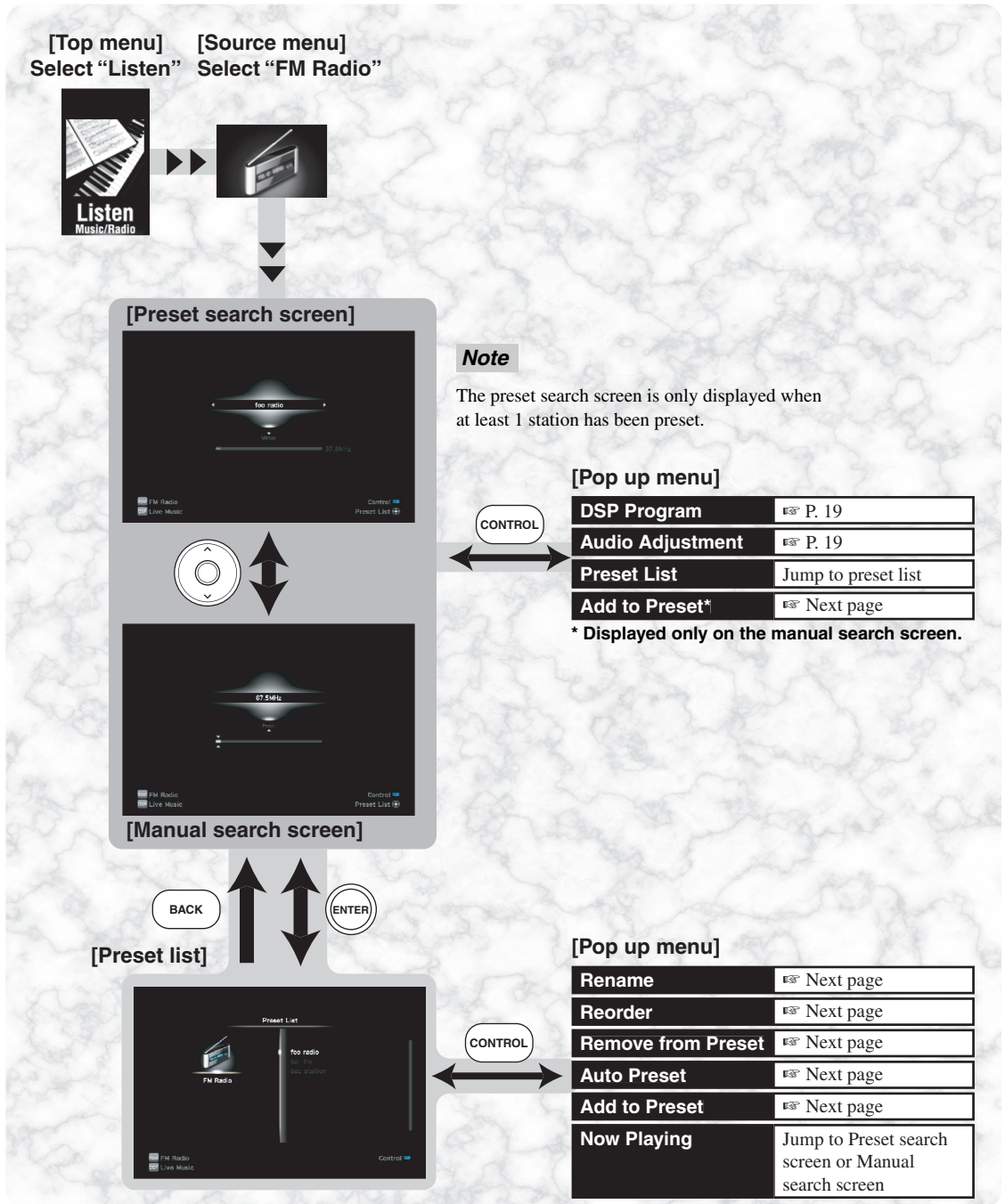

## Automatic station preset

This unit scans all FM frequencies and registers receivable stations on the preset list. The registered stations can be recalled easily.

Select “**Auto Preset**” from the pop up menu on the preset list screen and select “**Start**” to start automatic station presetting.

This unit starts to seek frequencies and register receivable FM radio stations on the preset list.



- To stop the automatic station preset procedure, press **BACK**.
- You can preset up to 40 stations.

### Note

When you perform automatic station presetting, any stations which were previously registered are deleted from the preset list.

## Recalling a preset station

- **Recalling a preset station from the preset list**

Select the desired station on the preset list.

- **Recalling a preset station on the preset search screen.**

Press **</>** to tune in to the previous/next preset station.

## Frequency tuning

On the manual search screen, tune into the desired station as follows:

- **Press and hold > to search for a higher frequency station.**
- **Press and hold < to search for a lower frequency station.**
- **Press > to repeatedly to tune in to a higher frequency manually.**
- **Press < to repeatedly to tune in to a lower frequency manually.**



- When this unit is tuned in to a station, “**TUNED**” appears.
- If the station is not registered on the preset list, select “**Add to Preset**” from the pop up menu.

## Editing the station preset list

- **Renaming the station name on the station preset list**

- 1 On the preset list screen, select “**Rename**” from the pop up menu.
- 2 Enter the desired station name, then select “**OK**”.

- **Reordering the preset stations**

- 1 On the preset list screen, select “**Reorder**” from the pop up menu.
- 2 Move the selected station, then press **ENTER** on the remote control.

- **Deleting a station from the station preset list**

- 1 On the preset list screen, select “**Remove from Preset**” from the pop up menu.
- 2 Select “**Remove**” to remove the station.



# Listening to music stored on your PC (YMC-700 only) or USB device

Use this feature to enjoy the music contents stored on your PCs and USB storage devices.

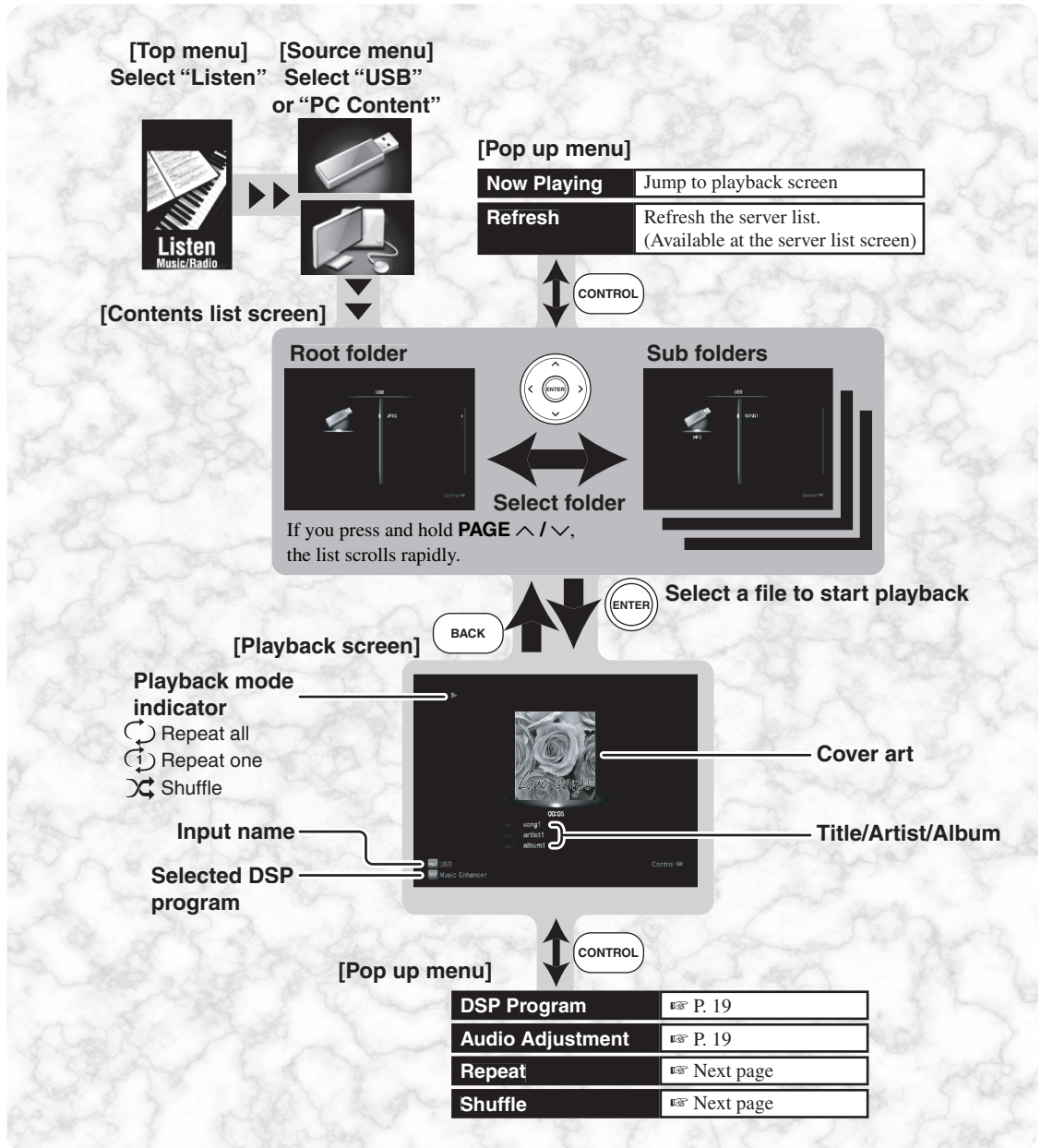

## Note

If any message appears, refer to "Troubleshooting". (P. 48)

Supported USB storage devices P. 2  
Network settings P. 40

### Note

Some audio files may not be playable or may be noisy when played.

#### Notes on USB devices

- When you connect your USB storage device, there may be a delay of about 10 seconds.
- Only the first partition is displayed on the GUI menu. You cannot select files in other partitions.
- Up to 8 levels of folder hierarchy and 500 files and folders per folder are recognized.
- Some devices may not work properly even if they meet the requirements.

## Before enjoying the contents on your PC (YMC-700 only)

With Windows Media Player 11, you can play back the audio files on your PC. For details, refer to the attached documents about Windows Media Player 11.

### 1 Install Windows Media Player 11 on your PC.

You can download the installer of Windows Media Player 11 from the Microsoft website, or use the upgrade function of the installed Microsoft Windows Media Player.

### 2 Turn on your PC then allow media sharing.

Activate Windows Media Player 11 first. Click the arrow below the “Library” tab, click “Media check box”, then select the “Share my media” check box in the “Media Sharing” dialog box. Select “YMC-700” in the list of devices below the “Share my media to” checkbox, and then click “Allow”.



YMC-700

### Notes

- If the operating system (OS) of your PC is Windows Vista, Windows Media Player 11 is pre-installed (except some products).
- Some types of security software installed on your PC (anti-virus software, firewall software, etc.) may block access of this unit to your PC. In such cases, configure the security software appropriately.
- You can connect this unit to up to 16 PC servers, and each server must be connected to the same subnet as this unit.

## Playing music files

### 1 Select a music file on the contents list screen.

### 2 Perform the playback operations by remote control.

#### ■ Operation on the playback screen

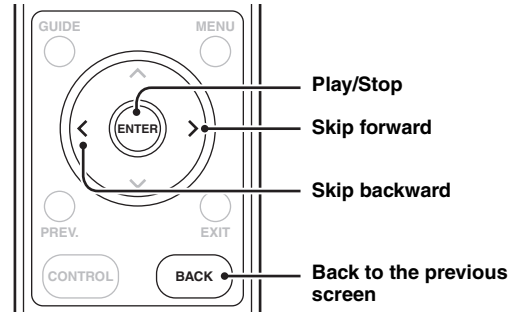

### Note

Some audio files may not be playable or may be noisy when played.

## Repeat play and shuffle play

### ■ Repeat play

Select “**Repeat**” from the pop up menu on the playback screen and select a repeat mode option.

Choice	Function
<b>Off</b>	Cancel repeat playback.
<b>Single</b>	Repeat a file.
<b>All</b>	Repeat a sequence of files.

### ■ Shuffle play

Select “**Shuffle**” from the pop up menu on the playback screen and select a shuffle mode option.

Choice	Function
<b>Off</b>	Cancel shuffle playback.
<b>On</b>	Shuffle playback.

# Viewing photos stored on your PC (YMC-700 only) or USB device

Use this feature to enjoy the photos stored on your PCs and USB storage devices.

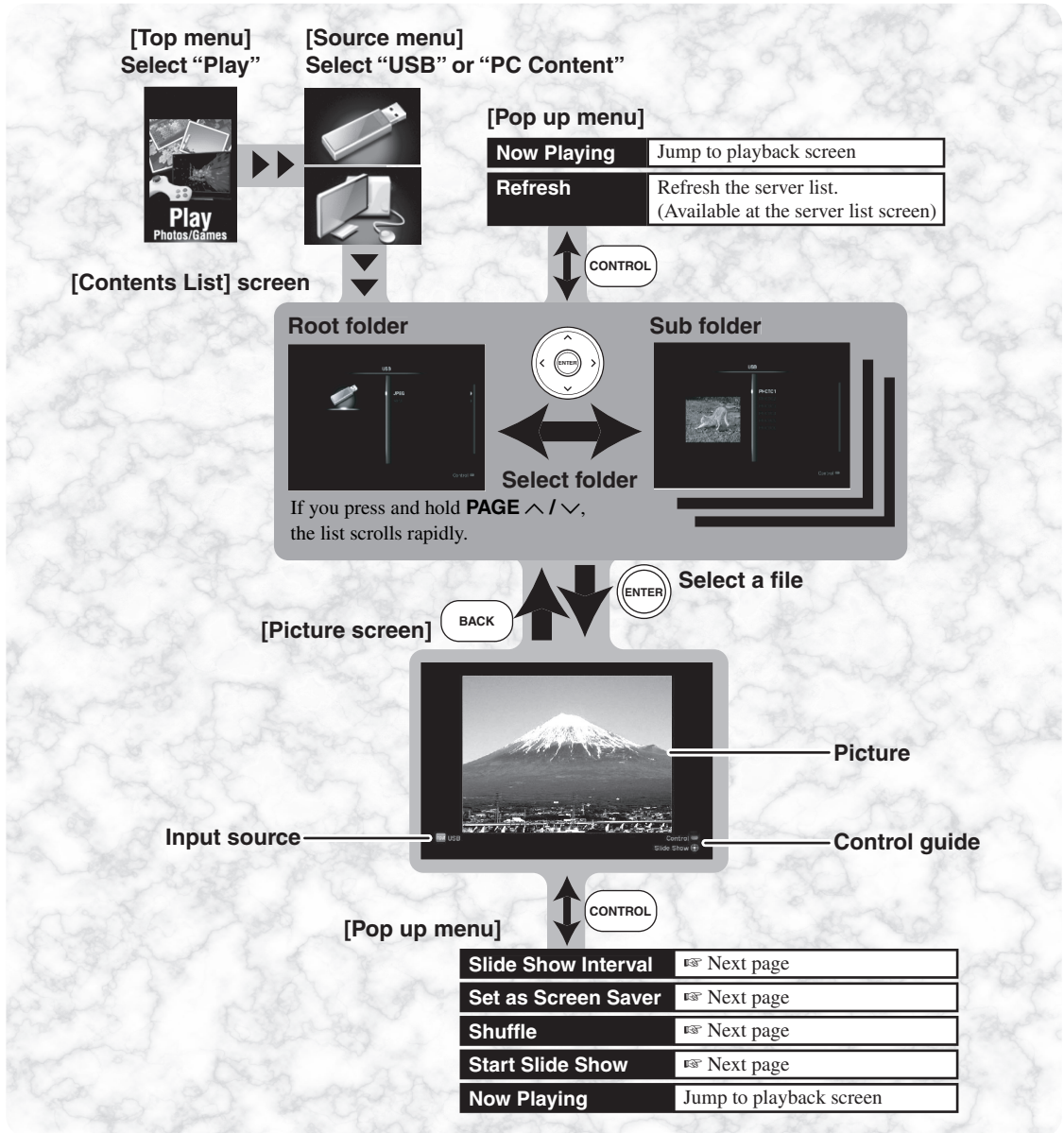

## Note

If any message appears, refer to "Troubleshooting". ( $\text{ESC}$  P. 48)

Supported USB storage devices [P. 2](#)  
 Network settings [P. 40](#)

## Viewing photos

To view the photos stored on your PC, allow sharing on the PC. [P. 25](#) “Before enjoying the contents on your PC (YMC-700 only)” on [P. 25](#).

**1 Select a photo file on the contents list screen.**

**2 Browse photos.**

If any video or music source is being played back, playback of the audio continues.

### ■ Operation on the picture screen

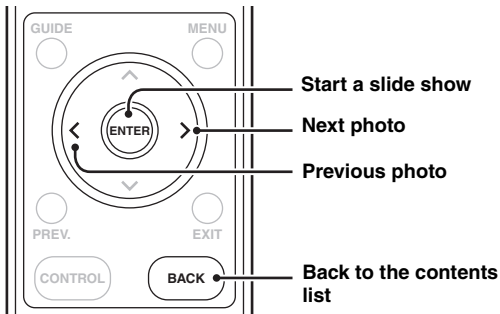

## Shuffle browsing

Photos are displayed at random. This setting is valid for the slide show function.

Select “**Shuffle**” from the pop up menu on the picture screen and select a shuffle mode option.

Choice	Function
<b>Off</b>	Invalidate shuffle browsing.
<b>On</b>	Shuffle browsing.

## Using photos as a screen saver

You can set your favorite photos as a screen saver.  
 Screen saver [P. 44](#)

Display a photo, select “**Set as Screen Saver**” from the pop up menu on the picture screen, then select “**Set**”.

The photos in that folder are used for the screen saver.



You can test the screen saver by selecting “Preview” in the “Screen Saver” menu ([P. 44](#)).

## Slide show

The slide show function shows the photos in the folders automatically. The slide show repeats itself.

Select “**Start Slide Show**” from the pop up menu on the picture screen to start a slide show.

To stop the slide show, press **BACK**.



You can start a slide show by pressing **ENTER** on the Picture screen.

### ■ Setting the slide show interval time

Select “**Slide Show Interval**” from the pop up menu on the playback screen and select the interval time.

**2sec** **3sec** **5sec** **10sec** **20sec**

#### Note

Depending on the size of the photos and the playback status of this unit, the actual interval may be longer than the specified one.

# Enjoying contents stored on your iPod

Once you have stationed your iPod in a Yamaha iPod dock (such as the YDS-11, sold separately) connected to the DOCK terminal of this unit (☞ P. 7), you can enjoy the music or video contents stored on the iPod.

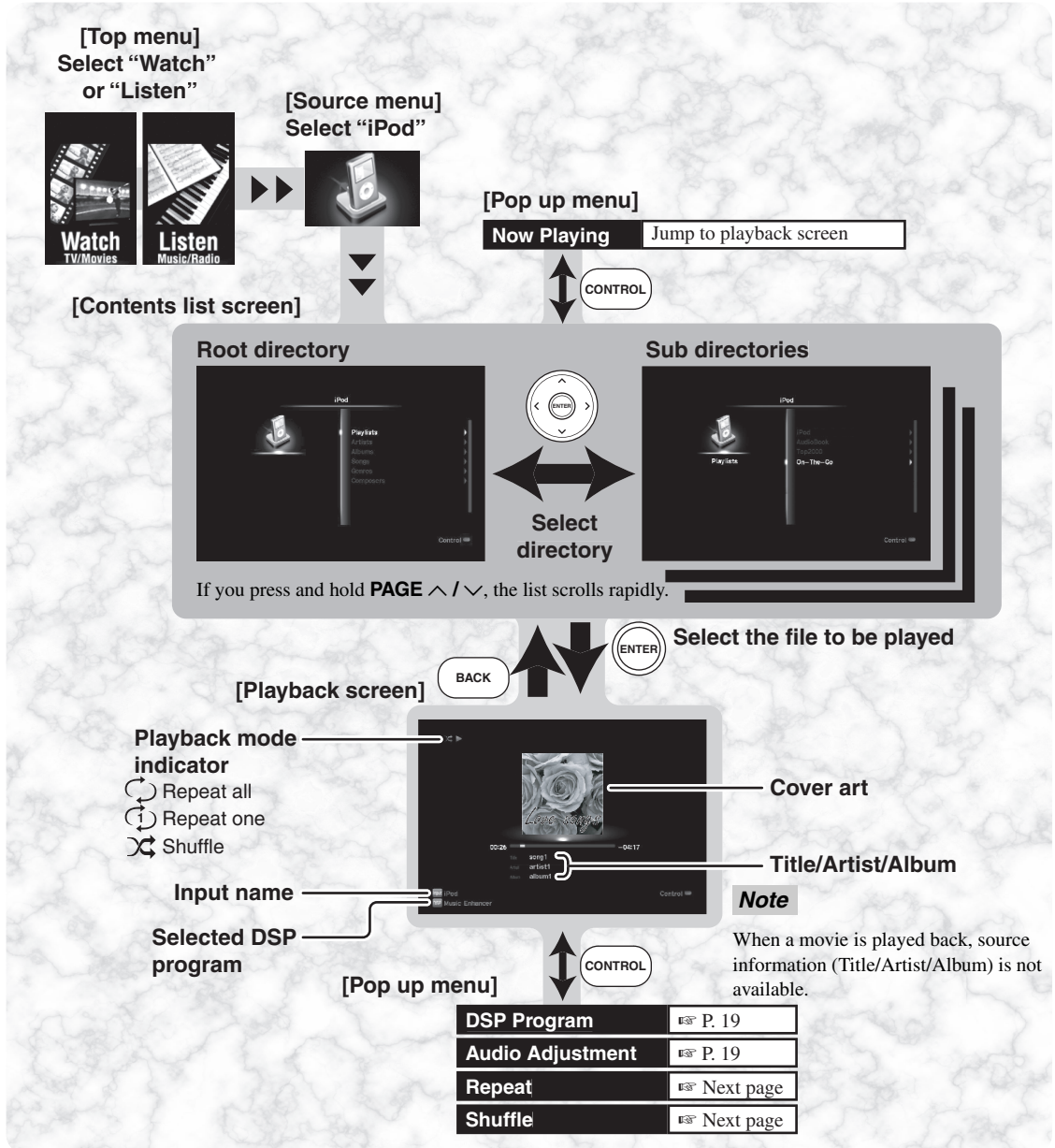

## Notes

- This unit is not compatible with photos stored on your iPod.
- This unit supports iPod touch, iPod (Click Wheel, including iPod classic), iPod nano and iPod mini.
- If any message appears, refer to "Troubleshooting". (☞ P. 49)
- Some features may not be compatible depending on the model or the software version of your iPod.
- Some features may not be compatible depending on the model of your Yamaha iPod universal dock.
- Depending on the type of iPod to be connected, the area for cover art may be narrowed.

## Listening to music contents

- 1 Select a song on the contents list screen.
- 2 Perform the playback operations by remote control.

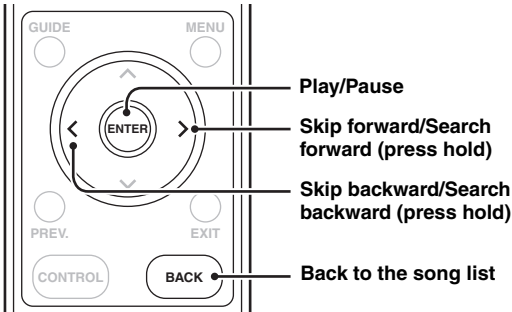

## Watching video contents

- 1 Select a video file on the contents list screen.
- 2 Perform the playback operations by remote control.

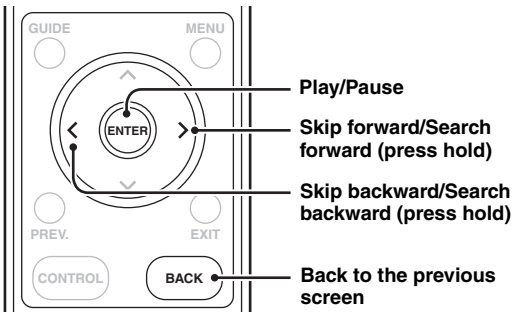

## Repeat play and shuffle play

The following functions are available upon playback of music/video contents. The detailed functions may differ depending on the connected iPod.

### Repeat play

Select “**Repeat**” from the pop up menu on the playback screen, then select a repeat mode option.

Choice	Function
<b>Off</b>	Cancel repeat playback.
<b>One</b>	Repeat a song.
<b>All</b>	Repeat a sequence of songs.

### Shuffle play

Select “**Shuffle**” from the pop up menu on the playback screen, then select a repeat mode option.

Choice	Function
<b>Off</b>	Cancel shuffle playback.
<b>Songs</b>	Play songs in random order.
<b>Albums</b>	Play albums in random order.

# Listening to Internet Radio (YMC-700 only)

Use this feature to listen to Internet Radio stations. This unit uses the vTuner Internet Radio station database service particularly customized for this unit, providing a database of over 2000 radio stations. You can store your favorite stations with bookmarks.

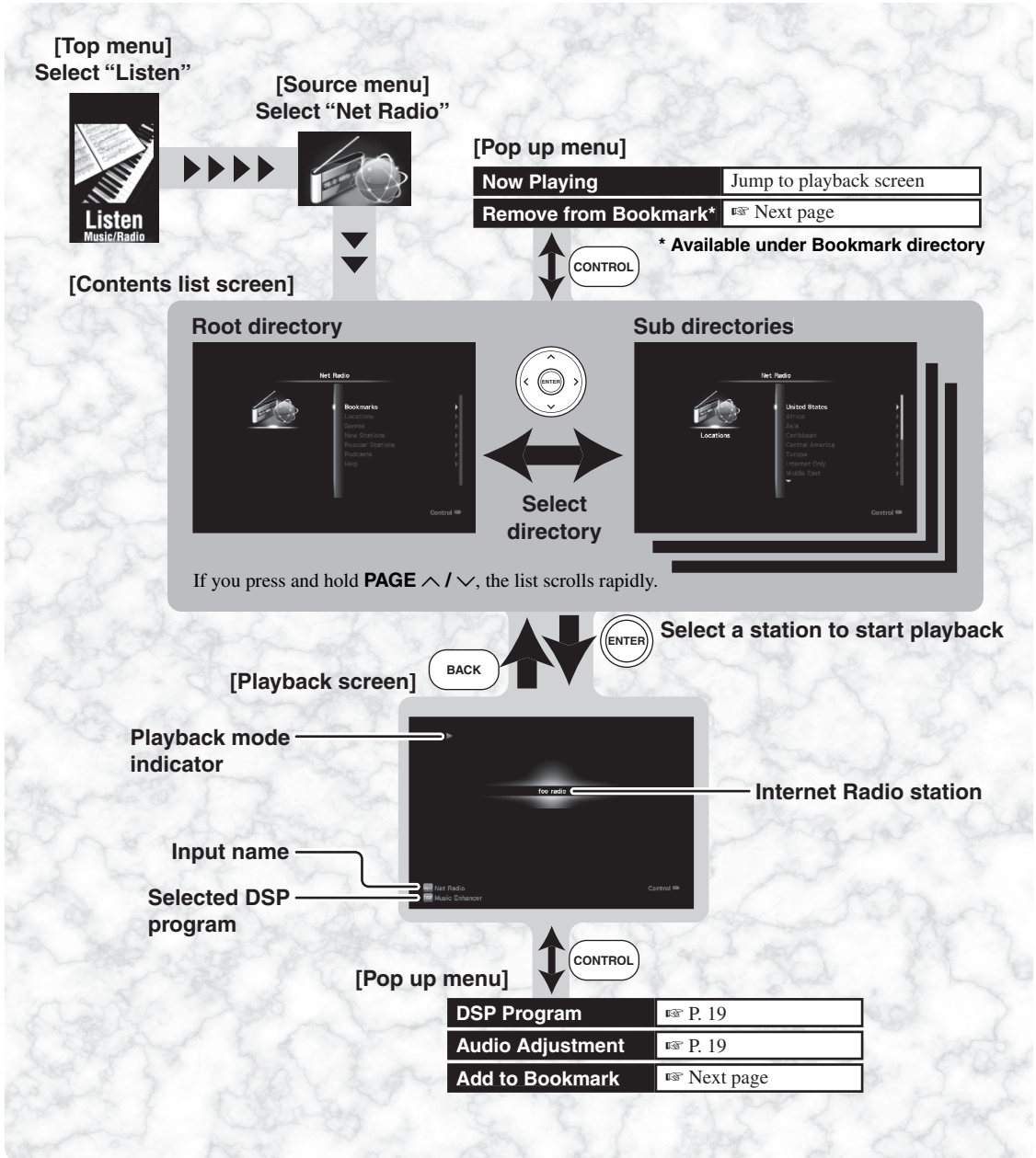

**Notes**

- To use this feature, you need a network connection.  
*Connection* ⓘ P. 6  
*Network setting* ⓘ P.40
- A narrowband Internet connection (i.e. 56k modem ISDN) will not provide satisfactory results. And a broadband connection is strongly recommended (i.e. a cable modem, an xDSL modem, etc.). For detailed information, consult with your ISP.
- Some security devices (such as firewalls) may block the access of this unit to Internet Radio stations or to the Rhapsody® server. In such cases, configure the security settings appropriately.
- If any message appears, refer to “Troubleshooting”. (ⓘ P. 48)

## ■ Storing your favorite Internet Radio stations with bookmarks

Use this feature to select your favorite Internet Radio stations quickly.

Select the desired Internet Radio station, then select “**Add to Bookmark**” from the pop up menu.

The stored Internet Radio station is added to the “Bookmarks” list in “Net Radio”.



- To remove the stored station from the “Bookmarks” list, select the station under “Bookmarks”, then select “**Remove from Bookmark**” from the pop up menu.
- You can also register your favorite Internet Radio stations on this unit by accessing the website with the web browser on your PC. To use this feature, you need the vTuner ID of this unit and your e-mail address to create your personal account. Refer to “Information” in the “Network” menu for the vTuner ID of this unit (ⓘ P. 41). For details, refer to the help information on the website. URL: <http://yradio.vtuner.com/>

**Notes**

- This service may be discontinued without notice.
- Some Internet Radio stations may not be played.

## ■ Operation on the playback screen

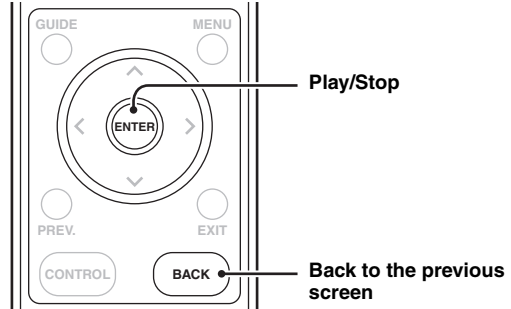



# Listening to the Rhapsody® service (YMC-700 only)

Use this feature to listen to the Rhapsody® music service.

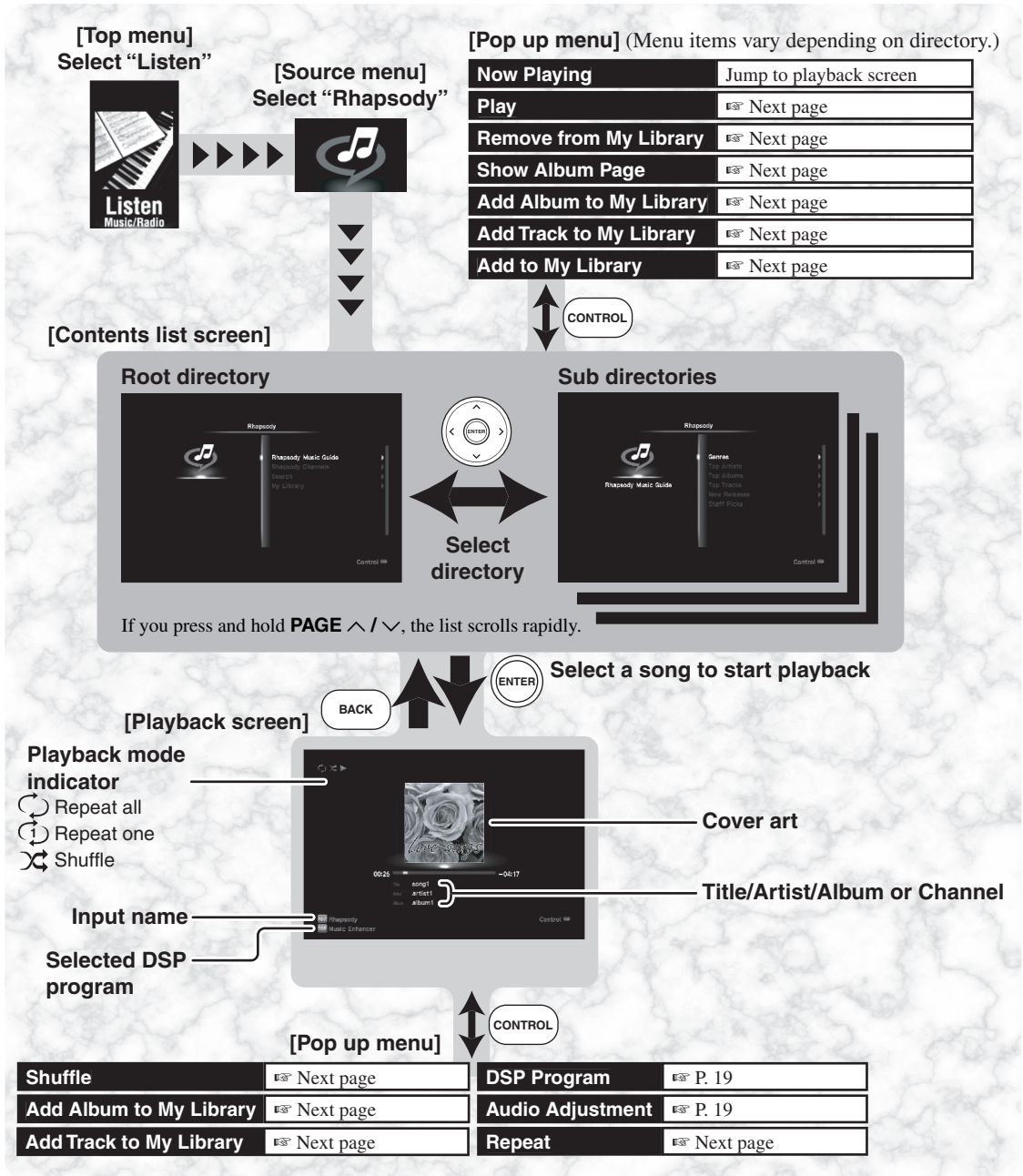

## Note

If any message appears, refer to "Troubleshooting". (P. 48)

## ■ Account setup for Rhapsody®

When you select “Rhapsody” for the first time, the account setup screen appears. Follow the procedure below to set up your account for the Rhapsody® service.

### 1 Select “Sign In to your account” on the account setup screen.



If you select “Start Free 30-day trial”, you can try the service for free for 30 days.

### 2 Enter your user name and password (up to 64 characters each) by using the displayed keyboard, then select “OK”.

“Please wait...” appears, followed by the confirmation screen.

### 3 Select “OK” to complete the Sign In procedure.



Use “Rhapsody Information” in “Setup” to check and edit the account information of the Rhapsody® service (P. 41).

## ■ Playback

### 1 Select “Rhapsody Music Guide”.



- Use “Rhapsody Channels” to browse the channels provided by the Rhapsody® service.
- Use “My Library” to register and access the desired albums and songs easily.
- You can search contents by keyword. Select “Search”, then “Artist”, “Album”, or “Track”. Enter the desired keyword using the virtual keyboard, then select “OK”.

### 2 Browse the contents list to select the desired song. The playback screen appears.



- Select “**Play**” from the pop up menu to play back the selected item directly.
- You can move to the album of the selected item in the list directly. Select a song, then select “**Show Album Page**” from the pop up menu.

## ■ Operations on the playback screen

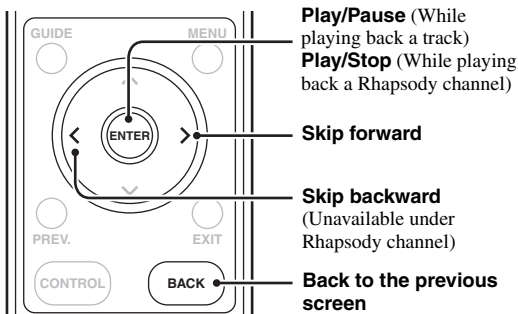

## Useful functions

### ■ Library

You can gather your favorite tracks and albums into a library called “My Library”.

Use the following pop up menu items to edit “My Library”:

#### Add to My Library

Add the currently selected track or album to “My Library”.

#### Add Track to My Library

Add the currently selected track to “My Library”.

#### Add Album to My Library

Add the currently selected album to “My Library”.

#### Remove from My Library

Remove the currently selected track or album from “My Library”. Select “**Remove**” to remove it.

### ■ Repeat play

Select “**Repeat**” from the pop up menu on the playback screen and select a repeat mode option.

Choice	Function
<b>Off</b>	Cancel repeat playback.
<b>Single</b>	Repeat a song.
<b>All</b>	Repeat a sequence of songs.

### ■ Shuffle play

Select “**Shuffle**” from the pop up menu on the playback screen and select a shuffle mode option.

Choice	Function
<b>Off</b>	Cancel shuffle playback.
<b>On</b>	Shuffle playback.

**Prohibition**

It is strictly prohibited to modify, reproduce, reverse-engineer or use this unit and/or built-in software for use other than audiovisual purposes.

The Rhapsody® service is the power behind the Rhapsody® Media Player (the Rhapsody® player software that you can download to your computer). Rhapsody® service supplies the music, keeps My Library up to date, provides you with Rhapsody® channels, the Playlist Central online community, and manages your downloads. Your software connects to Rhapsody® service through the internet. Because your account information and Rhapsody® content are on servers instead of any individual computer, your music is infinitely portable. Much of what you see in the Display area comes from Rhapsody® service. What you can do with Rhapsody® service depends on your subscription. You can use Rhapsody® service for free, or get even more from a paid membership. The Rhapsody® service also brings you Rhapsody® Online, a streamlined, internet version of Rhapsody® that you can access from almost anywhere. Just sign in to your Rhapsody® account to start letting the Rhapsody® service work for you. For more information, <http://www.rhapsody-free.com/>.

# Enjoying Bluetooth™ components

Use this feature to enjoy the music contents stored on your Bluetooth component (such as a portable music player) without wiring between this unit and the Bluetooth component.

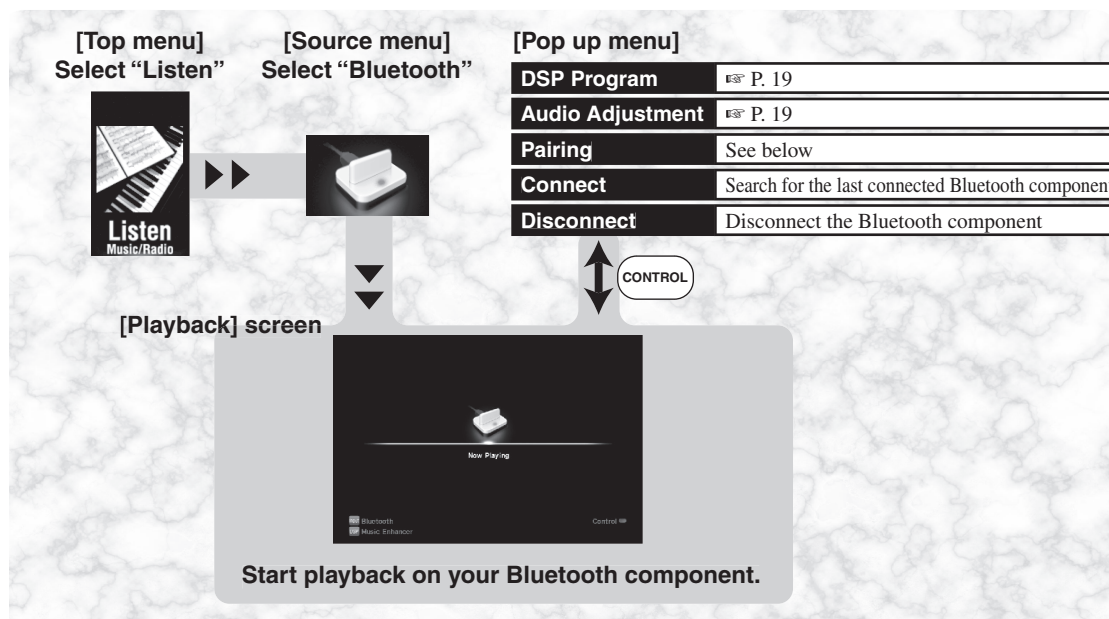

To use this feature, you need perform the following operations in advance.

- Connecting a Yamaha Bluetooth receiver (P. 7).
- Pairing the desired Bluetooth component (see below).
- Establishing the connection between the desired Bluetooth component and the Bluetooth receiver.

This unit supports A2DP (Advanced Audio Distribution Profile) Bluetooth profiles.

## Pairing

Pairing must be performed when using a Bluetooth component with the Bluetooth receiver connected to this unit for the first time or if the pairing data has been deleted. "Pairing" refers to the operation of registering a Bluetooth component for Bluetooth communications.

- 
- You only need to perform the pairing operation the first time.
  - Pairing requires operations on this unit and on the other component with which Bluetooth communications are to be established. If necessary, refer to the other component's operating instructions.

To ensure security, a time limit of 8 minutes is set for the pairing operation. You are recommended to read and fully understand all the instructions before starting.

**1 Turn on your Bluetooth component, then set the Bluetooth component to the pairing mode.**

**2 Select "Pairing" from the pop up menu and check that the Bluetooth component detects the Bluetooth receiver.**

If the Bluetooth component detects the Bluetooth receiver, "YBA-10 YAMAHA" (example) appears on the Bluetooth device list.

**3 Select the Bluetooth receiver on the Bluetooth device list, then enter the pass key "0000" on the Bluetooth component.**

When the pairing procedure is successful, "Pairing Completed" appears.

### Notes

- If any message appears, refer to "Troubleshooting". (P. 50)
- The Yamaha Bluetooth receiver can be paired with up to eight Bluetooth components. When pairing is conducted successfully with a ninth component and the pairing data is registered, the pairing data for the least recently used other component is cleared.

# Setup menu

## Setup menu tree

You can change the settings of this unit with the Setup menu. Enter the Setup menu from the bottom right corner of the top menu.

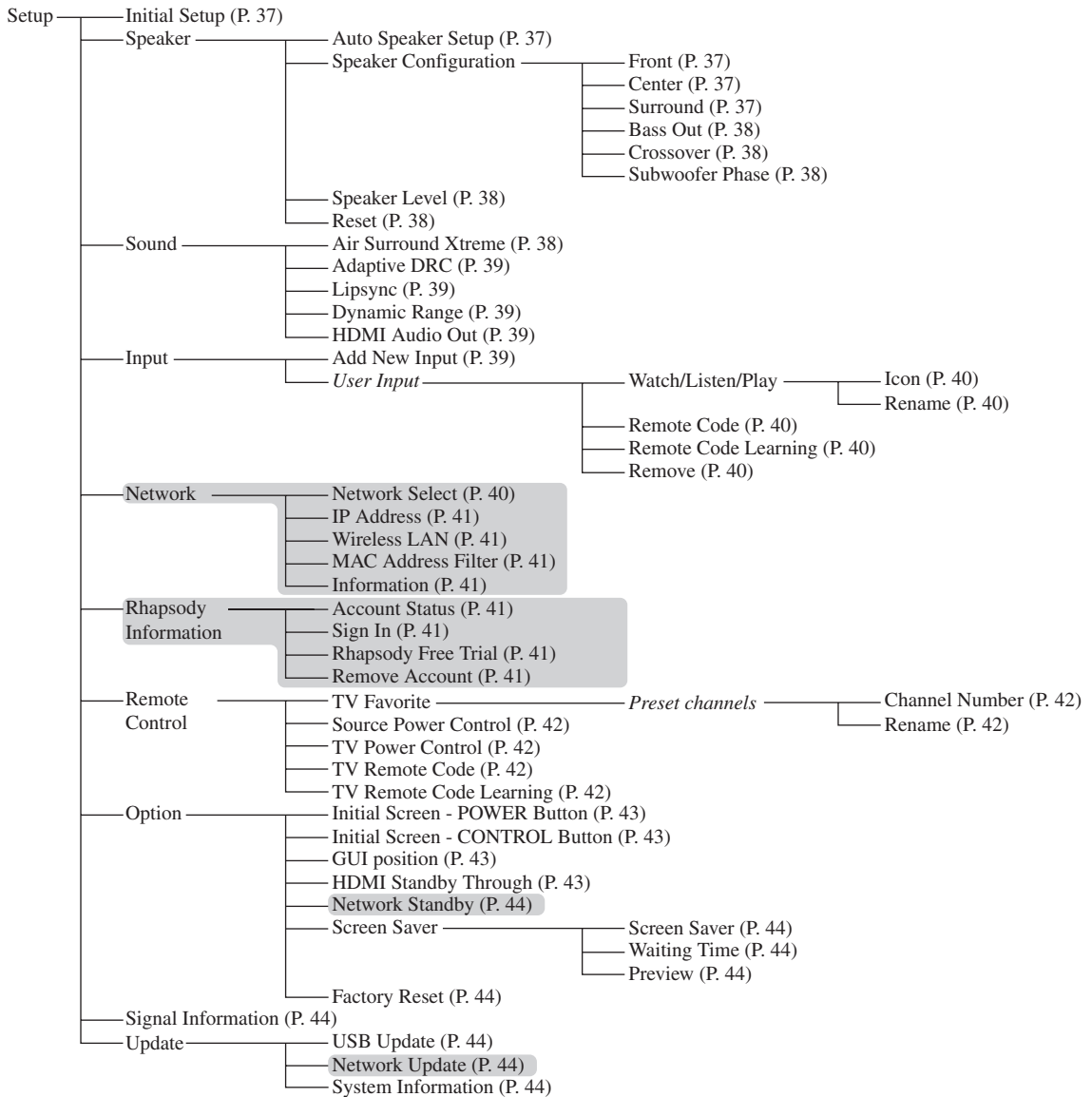

### Note

The shaded menu items are only applicable to YMC-700.

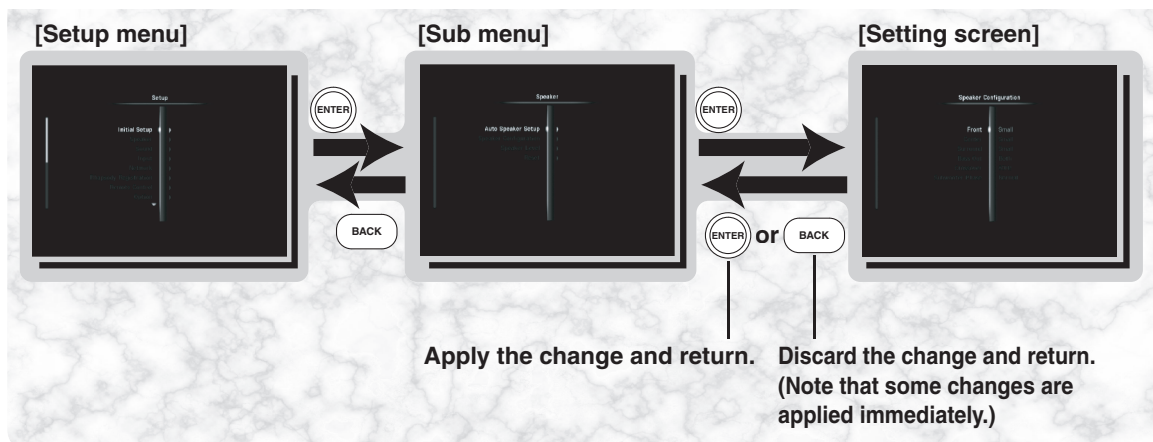

## Initial Setup

Initial Setup (P. 10)

## Speaker menu

Almost all settings are optimized by the Initial Setup procedure (P. 10). If you change the speaker layout or the speakers themselves after executing the Initial Setup process, use this menu to re-optimize the sound. The choices indicated in bold are selected by default.

### ■ Auto Speaker Setup

Select “Start” and follow steps 6 to 11 at “Step 1: Auto Speaker Setup”. (P. 10)

### ■ Speaker Configuration

#### Determining the speaker size

If the speaker’s woofer section is:

- 16 cm (6.5 in) or larger: large
- smaller than 16 cm (6.5 in): small

#### Front

Choice	Descriptions
Large	Select this setting when the front speakers are large.
<b>Small</b>	Select this setting when the front speakers are small.

#### Note

When “Bass Out” is set to “Front”, you can only select “Large” for “Front”. If “Front” has been set to anything other than “Large” before, this unit changes the value to “Large” automatically.

#### Center

Choice	Descriptions
Large	Select this setting when the center speaker is large.
<b>Small</b>	Select this setting when the center speaker is small.
None	Select this setting when no center speaker is being used.

#### Surround

Choice	Descriptions
Large	Select this setting when the surround speakers are large.
<b>Small</b>	Select this setting when the surround speakers are small.
None	Select this setting when no surround speakers are being used.

## Bass Out

Use this feature to select the speakers from which the LFE (low-frequency effect) and the low-frequency signals will be output.

### Output of LFE signals

Choice	Subwoofer and speakers		
	Subwoofers	Front speakers	Other speakers
<b>Both</b>	Output	Not output	Not output
Subwoofer	Output	Not output	Not output
Front	Not output	Output	Not output

### Output of low-frequency signals

Choice	Subwoofer and speakers		
	Subwoofers	Front speakers	Other speakers
<b>Both</b>	*1	*2	*3
Subwoofer	*4	*3	*3
Front	Not output	*1	*3

\*1 Output(s) the low-frequency signals of the front channels and other speakers set to “Small”.

\*2 Always output the low-frequency signals of the front channels.

\*3 Output the low-frequency signals if the speakers are set to “Large”.

\*4 Outputs the low-frequency signals of the speakers set to “Small”.

### Note

When “Front” is selected, you cannot adjust the subwoofer level using the pop up menu.

## Crossover

Use this feature to select the crossover frequency of speakers that are set to “Small”. All frequencies below the selected frequency are sent to the subwoofer or to the speakers set to “Large”.

Choices: 40Hz, 60Hz, **80Hz**, 100Hz, 120Hz, 160Hz, 200Hz

## Subwoofer Phase

Use this feature to switch the phase of your subwoofer if the bass sound is too weak or unclear.

Choice	Functions
<b>Normal</b>	Does not change the phase of your subwoofer.
Reverse	Sets the phase of the subwoofer to reverse.

## Speaker Level

Use this feature to manually balance the speaker levels.

Control range: -20 to +20 (Test Tone: Off, On)

Initial setting: 0 (Test Tone: Off, SWFR: +6)

Control step: 1

Choice	Adjusted speaker
Test Tone	Turns the test tone output on or off.
FL	Adjusts the front left speaker level.
FR	Adjusts the front right speaker level.
C	Adjusts the center speaker level.
SL	Adjusts the surround left speaker level.
SR	Adjusts the surround right speaker level.
SWFR	Adjusts the subwoofer level.

## Reset

Use this menu to reset the speaker settings.

Choice	Functions
<b>Yes</b>	Resets the speaker related settings.
No	Cancels resetting.

## Sound menu

Use this menu to change the various sound settings.

The choices indicated in bold are selected by default.

## Air Surround Xtreme

The AIR SURROUND XTREME technology enables you to enjoy up to 7.1-channel sound (when multi-channel PCM signals are input) without using surround speakers by simulating sound from virtual speakers.

Choice	Functions
<b>On</b>	Turns on the AIR SURROUND XTREME function.
Off	Turns off the AIR SURROUND XTREME function.

### Notes

- When surround speakers are connected, “- -” is displayed and you cannot set the “Air Surround Xtreme” setting. The AIR SURROUND XTREME function is not available in this case.
- When DSP Program is set to “Off” or “Music Enhancer”, the AIR SURROUND XTREME function is deactivated.
- When “Air Surround Xtreme” is set to “Yes”, the connected external sources output Dolby Digital or PCM signals instead of Dolby TrueHD or Dolby Digital Plus signals. For details, refer to the owner’s manual of the component.

## ■ Adaptive DRC (dynamic range control)

Use this feature to adjust the dynamic range in conjunction with the volume level. It improves listenability at low volume.

Choice	Functions
Auto	Adjusts the dynamic range automatically.
<b>Off</b>	Does not adjust the dynamic range automatically.

When “Adaptive DRC” is set to “Auto”, this unit controls the dynamic range as follows:

- If the volume setting is low: the dynamic range is narrow
- If the volume setting is high: the dynamic range is wide

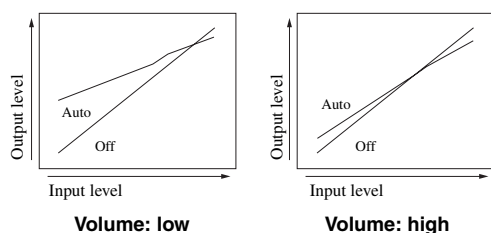

You can also adjust the dynamic range of the bitstream signal sources (Dolby Digital, Dolby Digital Plus, Dolby True HD and DTS signal) by using the “Dynamic Range” menu.

## ■ Lipsync

Use this menu to adjust the audio and video synchronization.

### If the connected TV is compatible with the automatic lip sync function

The Lipsync mode of this unit is set to “Auto”, and you can fine-adjust the audio and video synchronization by adjusting the offset value.

Control range: –240 through **0** to 240 ms (the range varies depending on the result of automatic measurement)

Control step: 1 ms

### If the connected TV is not compatible with the automatic lip sync function

The Lipsync mode of this unit is set to “Manual”. Adjust the delay of the sound output manually to synchronize the sound with the picture.

Control range: **0** to 240 ms

Control step: 1 ms

## ■ Dynamic Range

Selects the dynamic range adjustment method for reproducing bitstream signals (Dolby Digital, Dolby Digital Plus, Dolby True HD and DTS signal).

Choice	Functions
Min/Auto	(Min) Sets the dynamic range suitable for low volume or a quiet environment, such as at night, for bitstream signals (excluding Dolby TrueHD signals). (Auto) Adjusts the dynamic range for Dolby TrueHD signals based on input signal information.
Std	Sets the standard dynamic range recommended for regular home use.
<b>Max</b>	Outputs sound without adjusting the dynamic range of the input signals.

## ■ HDMI Audio Out

Use this menu to select whether to play back HDMI audio signals on this unit or on the TV connected to this unit.

Choice	Functions
<b>Amp</b>	Outputs HDMI audio signals from the speakers connected to this unit.
TV	Outputs HDMI audio signals from the speakers of the TV.

### Notes

- If “HDMI Audio Out” is set to “TV”, the available audio signals vary depending on the specifications of the connected TV.
- When “HDMI Audio Out” is set to “TV” and the audio signals are output from the HDMI OUT jack, the speakers connected to this unit output no sound.
- Even if “HDMI Audio Out” is set to “TV”, the sound signals of some sources are not output from the HDMI OUT jack. In this case, sound is output from the speakers connected to this unit.

## Input menu

Use this menu to add new input sources or change the input source settings you have made with the Initial Setup procedure.

The choices indicated in bold are selected by default.

## ■ Add new input

When you connect new components to this unit or modify the connections between this unit and other components, use this menu to reflect the new connections. Follow steps 2 to 4 at “Step 3: Source Device Setup”. (P. 15)



- **User Input** (“Cable”, “SAT”, “DVD”, etc. — the name of an input source you have added before)

### Watch/Listen/Play

You can customize the icons under the activities displayed on the source screen for each component. For example, if you listen to a CD using the DVD player frequently, you can add the “CD” icon under the “Listen” activity and rename the icon to “CD/DVD-P”.

Selectable icons are as follows:

**LiveTV, Movie, DVR, Game, Apple TV, CD, Other, None** (Select “None” when you want to delete the assigned icon from the selected activity.)

You can rename icons with up to eight characters.

### Remote Code

Use this menu to switch the remote control code for the component. Follow steps 6 to 15 at “Step 3: Source Device Setup”. (ⓘ P. 15)

### Remote Code Learning

Use this menu to add/change remote control codes. See below.

### Remove

Use this menu to remove any component you have added.



If you change the connections between this unit and source devices, first remove the input settings, then make new settings using the “Add new input” menu (ⓘ P. 39).

## ■ Programming remote control codes from other remote controls

You can program remote control codes from other remote controls. Use the learning feature if you want to program functions not included in the basic operations.

### 1 Select the source device’s type.

If any remote control code has been set already, skip this step.

### 2 Select a button on the remote control or the virtual remote control.

You can program the functions of other remote controls to the following buttons.

- **GUIDE, MENU, PREV., EXIT, ^ / ∨ / < / >, ENTER, CH ^ / ∨, and PAGE ^ / ∨** on the remote control.
- Any of the virtual remote control buttons (including buttons L1 to L14 (ⓘ P. 22))

### 3 Select “Learn” and immediately press and hold the button you want to program on the remote control until “Code learning was successful” appears.

If the target button is one of the L1 to L14 buttons, you can rename the button. Select “Rename” and rename the button.

If learning was unsuccessful, “Code learning failed” appears. In this case, place the remote control near the remote control sensor of this unit and select “Retry”, or select “Cancel” to cancel the learning process.



Aim the remote control of other devices at the remote control sensor of this unit within the range of 10 cm to 2.5 m (4 in. to 8 ft.).

### 4 To learn other codes, select “Learn next code” and repeat steps 1 to 3 until you finish “learning” all the desired code.

### 5 Select “Finished” and then “Yes” to exit the learning process.

#### Notes

- If the other remote control uses infrared rays, this unit can learn most of its function. However, you may not be able to program some special signals or extremely long transmissions.
- This unit does not support the control interfaces for game consoles.

## Network menu (YMC-700 only)

Use this menu to adjust the network parameters.

### ■ Network Select

Use this menu to select a connection method (wired or wireless).

Choice	Functions
Ethernet	This unit connects to a wired network.
WLAN	This unit connects to a wireless network.

## ■ IP Address

Use this menu to change the network parameters (IP address, etc.) manually.

### DHCP (DHCP setting)

Use this feature to select whether to allow this unit to obtain the network parameters (IP address, subnet mask, default gateway, primary DNS server and secondary DNS server) from the DHCP server of the connected network.

Choice	Descriptions
On	Select this setting to allow this unit to obtain the network parameters from the DHCP server of the connected network.
Off	Select this setting when you want to set the network parameters manually.

### IP Address (IP address)

Use this parameter to specify the IP address assigned to this unit. This value must not be the same as the one used for other devices in the target network.

### Subnet Mask (Subnet mask)

Use this parameter to specify the subnet mask value assigned to this unit.

### Default Gateway (Default gateway)

Use this parameter to specify the IP address of the default gateway.

### DNS Server (P) (Primary DNS server),

### DNS Server (S) (Secondary DNS server)

Use this parameter to specify the IP address of the primary and secondary DNS (Domain Name System) servers.



If you have only one DNS address, enter the DNS address in “DNS Server (P)”. If you have two or more DNS addresses, enter one of them in “DNS Server (P)” and another in “DNS Server (S)”.

## ■ Wireless LAN

When you select this menu item, this unit automatically begins to search for wireless networks. After searching is completed, follow the steps below.

**1 Select an access point, or select “Manual Setup” and enter the ESSID (the name of the wireless network named in the Wi-Fi settings).**

**2 Select the security type and input the security key for the network.**

When you select “None” as the security type, you are not required to input the security key.

**3 Select “Yes” to confirm the setting.**

## ■ MAC Address Filter

Use this feature to filter the access to this unit via LAN to control this unit by the MAC address of the accessing PC. Control range: 00 to FF for each field (Mac Address Filter: On, Off)

Choice	Functions
Mac Address Filter	Turns the MAC address filter function on or off. When “On” is selected, this unit accepts PCs whose MAC address is registered.
MAC Address 1 - 10	The MAC addresses of network devices which are allowed to connect to this unit.

## ■ Information

You can display the following network system information:

- MAC Address assigned to this unit
- IP Address
- Subnet Mask
- Default Gateway
- DNS Server (P)
- DNS Server (S)
- Link Status of the network (No Link/10Base-T/100Base-TX) and method of communication (Full Duplex/Half Duplex)
- WLAN Signal Level
- vTuner ID

## *Rhapsody® Information menu (YMC-700 only)*

Use this menu to check and change the account status of your Rhapsody® account.

### ■ Account Status

Shows the information regarding the account status. If “NOT AVAILABLE” appears, check the network settings.

### ■ Sign In

Enter your user name (up to 64 characters) and password (up to 64 characters) provided by the Rhapsody® service, then select “OK”.

#### Note

If Sign In fails, an error message appears. In this case, perform the Sign In procedure again.

### ■ Rhapsody Free Trial

A free 30-day trial of the Rhapsody® service is available. When you select this menu, the URL at which the terms of the trial service can be found appears. If you agree, select “Yes” to activate the trial account.

### ■ Remove Account

Select this menu to remove your account.

## Remote Control menu

Use this menu to set up remote control settings. The choices indicated in bold are selected by default.

### ■ TV Favorite

You can store up to 8 favorite TV channels and recall them by selecting the corresponding buttons on the virtual remote control.



The keys for the TV Favorite functions are displayed on the virtual remote control when Cable, Satellite/DSS, or DVR is selected as the type of the source device. Select "Fav" and the station name you registered.

### Channel Number

Enter the channel number of your favorite TV stations. You can enter up to 8 characters (numbers and hyphen).

### Rename

Use this menu to change the name of channels on the pop up menu displayed when you select "Fav" on the virtual remote control. (☞ P. 21)

### ■ Source Power Control

Use this menu to turn the Source Power Control function of this unit on or off (standby). The Source Power Control function controls the power of the components to which IR flashers are attached. This function works as follows:

- When you select an input source, this unit turns on the corresponding component.
- When you set this unit to the standby mode, this unit turns off the connected components.

Choice	Functions
<b>Enable</b>	The Source Power Control function is enabled.
Disable	The Source Power Control function is disabled.

#### Note

You need to attach the IR flashers to the components and configure the remote control settings in advance.

### ■ TV Power Control

Use this menu to turn on or off the TV Power Control function of this unit. The TV Power control function controls the power of the TV to which the IR flasher is attached. This function works as follows:

- When you turn on this unit, this unit turns on the TV.
- When you set this unit to the standby mode, this unit turns off the TV.

Choice	Functions
<b>Enable</b>	The TV Power Control function is enabled.
Disable	The TV Power Control function is disabled.

#### Note

You need to attach the IR flasher to the TV and configure the remote control setting in advance.

### ■ TV Remote Code

Use this menu to change the remote control code of the connected TV. Follow steps from 2 to 8 of "Step 2: TV Remote Control Setup" (☞ P. 13).

### ■ TV Remote Code Learning

If the remote control code set with the "TV Remote Code" menu does not function correctly, use the learning feature to program the remote control code manually.

## 1 Select a button to learn.

### TV POWER

Learn the code of the button for switching the TV's power on and off (standby) on the remote control included with the TV to control the TV's power using **TV POWER** on the remote control included with this unit. There is no need to learn the code here if the code is properly set at "TV Remote Control Setup" in the Initial Setup procedure.

### TV On

If the remote control included with the TV has a button exclusively for turning the TV's power on, learn its code.

### TV Off

If the remote control included with the TV has a button exclusively for turning the TV's power off, learn its code.



When the TV On and TV Off codes are learned, the TV's power can be accurately controlled from this unit.

## 2 Select “Learn” and immediately press the TV power control button on the remote control of the TV.

When learning was successful, “Code learning was successful” appears.

If learning was unsuccessful, “Code learning failed” appears. In this case, place the remote control near the remote control sensor of this unit and select “Retry”, or select “Cancel” to cancel the learning process.



Aim the remote control of the TV at the remote control sensor of this unit within the range of 10 cm to 2.5 m (4 in. to 8 ft.).

## 3 Select “Finished” and then “Yes” to exit the learning process.

### Note

If the other remote control uses infrared rays, this unit can learn most of its function. However, you may not be able to program some special signals or extremely long transmissions.

## Option menu

You can adjust the optional system settings. The choices indicated in bold are selected by default.

### Initial Screen - POWER Button

You can set the initial screen displayed when this unit is turned on using **POWER**.

Choice	Functions
<b>Top Menu</b>	The top menu is displayed when this unit is turned on.
Last	The playback screen of the audio source you listened to the last time is displayed when this unit is turned on.
<i>Activities</i>	The playback screen of the selected input source is displayed when this unit is turned on. You cannot select FM Radio, Rhapsody, Net Radio, PC Content, Bluetooth, or USB.

### Initial Screen - CONTROL Button

You can set the initial screen displayed when this unit is turned on using **CONTROL** on the remote control.

### Note

You cannot use this feature with **CONTROL** on the top panel.

Choice	Functions
<b>Top Menu</b>	The top menu is displayed when this unit is turned on.
Last	The playback screen of the audio source you listened to the last time is displayed when this unit is turned on.
<i>Activities</i>	The playback screen of the selected input source is displayed when this unit is turned on. You cannot select FM Radio, Rhapsody, Net Radio, PC Content, Bluetooth, or USB.

### GUI position

Use this feature to adjust the vertical and horizontal position of the menu screen.

Control range: -5 (downward/left) to +5 (upward/right)

Button	Direction in which the GUI display moves
^	Up
v	Down
>	Right
<	Left



Press **ENTER** when the adjustment is finished.

### HDMI Standby Through

Use this feature to decide whether or not to allow the HDMI signals input to the HDMI IN jacks to pass through this unit when this unit is in the standby mode.

Choice	Functions
<b>Off</b>	Disables the HDMI standby through feature. HDMI signals do not pass through this unit when this unit is in the standby mode.
HDMI 1 - 3	HDMI signals pass through this unit (from the corresponding HDMI IN jack) even when this unit is in the standby mode. When in the standby mode, the power indicator is lit dimly.

### Note

When “HDMI Standby Through” is set to options other than “Off”, the amount of power consumed in the standby mode increases.

## ■ Network Standby (YMC-700 only)

Use this feature to select whether or not this unit will accept commands via LAN network when it is in the standby mode.

Choice	Descriptions
Off	Does not accept operations via LAN network when in the standby mode.
On	Accepts operations via LAN network when in the standby mode. When in the standby mode, the power indicator is lit dimly.

### Note

When “Network Standby” is set to “On”, the amount of power consumed in the standby mode increases.

## ■ Screen Saver

### Screen saver

Select a type of screen saver.

Choice	Functions
Off	Screen saver is not activated.
Logos	The Yamaha logo and neoHD logo are used for the screen saver.
Photos	The selected photos (P. 27) are used for the screen saver.

### Waiting time

Use this menu to set the amount of time before the screen saver is activated.

Control range: 1min to 10min

Initial setting: 5min

Control step: 1min

Press **ENTER** to set the value.

### Preview

When you select this menu, preview is displayed. Press **BACK** to return to the previous screen.

## ■ Factory Reset

Use this menu to reset the system to the factory defaults.

### Notes

- This procedure completely resets all the parameters of this unit.
- When you execute the “factory reset” command, this unit turns off then back on automatically.

Choice	Functions
Yes	Resets the system to the factory defaults.
No	Cancels resetting.

## Signal information

Use this to display audio and video signal information. The displayed information is as follows:

### Video information

Choice	Functions
Signal Type	Type of source video signal and video signal output from the HDMI OUT jack.
Resolution	Resolution of the input signal (analog or HDMI) and the output signal (HDMI).

### Audio information

Choice	Functions
Decode Status	Signal format.
Decode Channel	Number of source channels in the input signal.
Air Surround Xtreme	State of the Air Surround Xtreme function.

### Note

- “— — —” appears when this unit cannot display the corresponding information.
- Even if you make settings to output bitstreams directly, some players convert Dolby TrueHD or Dolby Digital Plus bitstreams to Dolby Digital bitstreams.

## Update menu

Use this menu to update the firmware of this unit. For details on how to update the firmware, refer to the information supplied with updates.

Choice	Functions
USB Update	Updates the firmware of this unit using the USB memory.
Network Update (YMC-700 only)	Updates the firmware of this unit via the network.
System Information	Displays the software version and system ID of this unit.



To start updating the firmware, select “USB Update” or “Network Update”.

### Note

- Do not use this feature unless you need to update the firmware.
- Be sure to read the information supplied with updates before performing firmware updates.
- DO NOT unplug the power cord during updating.

# Troubleshooting

Refer to the table below when this unit does not function properly. If the problem you are experiencing is not listed below or if the instructions below do not help, turn off this unit, disconnect the power cable, and contact the nearest authorized Yamaha dealer or service center.

## ■ General

Problem	Cause	Remedy	See page
<b>This unit fails to turn on or enters the standby mode soon after the power is turned on.</b>	The power cable is not connected or the plug is not completely inserted.	Connect the power cable firmly.	—
	The protection circuitry has been activated.	Make sure that all speaker wire connections on this unit and on all speakers are secure and that the wire for each connection is not touching anything other than its respective connection.	—
	This unit has been exposed to a strong external electric shock (such as lightning or strong static electricity).	Turn off this unit, disconnect the power cable, plug it back in after 30 seconds, then use it normally.	—
<b>No sound.</b>	Incorrect input assignment settings.	Use the Input menu and correct the assignment settings according to the actual connections.	39
	Incorrect input or output cable connections.	Connect the cables properly. If the problem persists, the cables may be defective.	6, Quick Start Guide
	No appropriate input source has been selected.	Select an appropriate input source.	19
	Speaker connections are not secure.	Secure the connections.	6
	The volume is turned down or muted.	Turn up the volume.	19
	Signals this unit cannot reproduce are being input from a source component, such as a CD-ROM.	Play a source whose signals can be reproduced by this unit.	—
	The “HDMI Audio Out” setting is set to “TV”.	Set the “HDMI Audio Out” setting to “Amp” to output sounds from speakers connected to this unit.	39
	The number of connected HDMI components is over the limit.	Reduce the number of HDMI components connected to the HDMI OUT jack.	—
	HDCP authentication failed because the HDMI components connected to this unit do not support the HDCP copy protection standards.	Connect HDMI components that support the HDCP copy protection standards.	—
<b>No picture.</b>	Non-standard video signals are being input.	Non-standard video signals may interfere the GUI screen of this unit. In this case, switch the format of the input signal or stop the signal.	—
	The number of connected HDMI components is over the limit.	Reduce the number of HDMI components connected to the HDMI OUT jack.	—
	HDCP authentication failed because the HDMI components connected to this unit do not support the HDCP copy protection standards.	Connect HDMI components that support the HDCP copy protection standards.	—
<b>The sound suddenly goes off.</b>	The protection circuitry has been activated because of a short circuit, etc.	Check that the speaker wires are not touching each other, then turn this unit back on.	—
<b>Sound is heard from the speaker on one side only.</b>	Incorrect cable connections.	Connect the cables properly. If the problem persists, the cables may be defective.	6
	The speaker level settings are incorrect.	Adjust the speaker level settings using the “Auto Speaker Setup” menu.	37

<b>Problem</b>	<b>Cause</b>	<b>Remedy</b>	<b>See page</b>
<b>Only the center speaker outputs substantial sound.</b>	When playing a monaural source with certain sound field programs, the source signal may be directed to the center channel, and the front and surround speakers only output effect sounds.	Select another DSP Program.	19
<b>No sound is heard from the center speaker.</b>	“Center” at “Speaker Configuration” is set to “None”.	Set “Center” to “Small” or “Large”.	37
<b>No sound is heard from the surround speakers.</b>	“Surround” at “Speaker Configuration” is set to “None”.	Set “Surround” to “Small” or “Large”.	37
	“Off” or “Music Enhancer” is selected as the DSP program and the source being played back contains no surround sound.	Select another DSP Program.	19
	A monaural source is being played back, and a certain DSP Program is selected.	Select another DSP Program.	19
<b>No sound is heard from the subwoofer.</b>	“Bass Out” in “Speaker Configuration” is set to “Front”.	Set “Bass Out” to “Subwoofer” or “Both”.	38
	The source does not contain low-frequency signals.		
<b>The audio input sources cannot be played in the desired digital audio signal format.</b>	The connected component is not set to output the desired digital audio signals.	Make an appropriate setting following the owner’s manual of your component.	—
<b>A humming sound is heard.</b>	Incorrect cable connections.	Connect the audio cables firmly. If the problem persists, the cables may be defective.	—
<b>This unit does not operate properly.</b>	The internal microcomputer has been frozen by an external electric shock (such as lightning or excessive static electricity) or by a power supply with low voltage.	Disconnect the power cable from the AC wall outlet, then plug it in again after about 30 seconds.	—
<b>There is noise interference from digital or radio frequency equipment.</b>	This unit is too close to the digital or high-frequency equipment.	Move this unit further away from such equipment.	—
<b>The picture is disturbed.</b>	The video source uses scrambled or encoded signals to prevent dubbing.		
<b>This unit suddenly enters the standby mode.</b>	The internal temperature is too high and the overheat protection circuitry has been activated.	Wait about 1 hour for this unit to cool down, then turn it back on.	—

## ■ FM Tuner

Problem	Cause	Remedy	See page
<b>FM stereo reception is noisy.</b>	The characteristics of FM stereo broadcasts may cause this problem when the transmitter is too far away or the antenna input is poor.	Check the antenna connections.	7
		Try using a high-quality directional FM antenna.	—
		Use the manual tuning method.	23
<b>There is distortion, and clear reception cannot be obtained even with a good FM antenna.</b>	There is multi-path interference.	Adjust the antenna position to eliminate multi-path interference.	—
<b>The desired station cannot be tuned in with the automatic tuning method.</b>	The signal is too weak.	Use a high-quality directional FM antenna.	—
		Use the manual tuning method.	23

## ■ Remote control

Problem	Cause	Remedy	See page
<b>The remote control does not work or does not function properly.</b>	Wrong distance or angle.	The remote control will function within a maximum range of 6 m (20 ft) and no more than 30 degrees off-axis from the front panel.	4
	Direct sunlight or lighting (from an inverter type fluorescent lamp, etc.) is striking the remote control sensor of this unit.	Reposition this unit.	—
	The batteries are weak.	Replace all the batteries.	5
	The batteries do not last long.	Using alkaline batteries is strongly recommended.	—
	The remote control code is not correctly set.	Set the remote control code correctly.	40, 42
		Try setting another code of the same manufacturer.	40, 42
The IR flashers are not connected/attached correctly.	Connect/attach the IR flashers properly. Also refer to the owner's manual of the external components.	8	
<b>Some buttons on the virtual remote control do not function.</b>	Remote control codes are directly transmitted to the remote control sensor of the target device.	Conceal the remote control sensor of the target device so that the remote control codes are received directly from the remote control.	—
<b>The remote control does not learn new functions.</b>	This unit and the remote control are too far apart or too close together.	Place the remote control within the range of 10 cm to 2.5 m (4 in. to 8 ft.).	—
	The batteries of the other remote control are too weak.	Replace all the batteries.	—
	There is noise interference from digital or radio frequency equipment.	If a CRT display or equipment connected to a CRT display is placed near this unit, move this unit away from such equipment.	—
		If metal objects are near this unit, move this unit away from them.	—



■ USB, Network, and Rhapsody

Problem	Cause	Remedy	See page
<b>“Access Error” is displayed even when a USB device is present.</b>	This unit has recognized the USB storage device as an unauthorized device.	Turn this unit off then on again.	—
<b>The music files and directories in the USB device cannot be viewed.</b>	The music files and directories are placed in locations other than the FAT area.	Place music files and directories in the FAT area.	—
	You are attempting to browse directory hierarchies of over 8 levels or a directory with more than 500 files.	Modify the data structure on your USB device.	—
<b>The PC server/ Internet Radio/ Rhapsody® does not function properly.</b>	The IP address is not set properly.	Set the DHCP server function of the router to ON. Alternately, perform manual configuration according to the current operating environment.	40
	The network cable is not connected.	Connect it properly.	6
<b>The music on the PC server cannot be played back.</b>	The PC does not have Windows Media Player 11 installed on it.	Install Windows Media Player 11 on the PC.	—
	The music is recorded in a format that cannot be played on this unit. This unit cannot play music formats other than WAV (PCM format only), MP3, WMA, MPEG-4 AAC, or FLAC. Also note that it cannot play certain music files even if these are recorded in the WAV (PCM format only), MP3, WMA, MPEG-4 AAC, or FLAC format.	Play music recorded in a format that this unit is compatible with.	—
<b>Internet Radio stations cannot be played.</b>	The firewall of the network device is activated. Internet Radio stations can only be played when the signal pass through the port designated by the individual radio stations. The port number varies from station to station.	Check the firewall setting of the network device.	—
	Connection to the Internet is disconnected.	Check the configuration of the network device, then contact the network connection provider.	—
<b>Image files cannot be displayed.</b>	The file format is other than JPEG.	Select JPEG image files.	—

Status message	Cause	Remedy	See page
<b>Access error</b>	This unit cannot access your USB storage device.	Try another USB storage device.	—
	There is a problem with the signal path from your USB storage device to this unit.	Turn off this unit and reconnect your USB storage device to the USB port of this unit.	—
		Try resetting your USB storage device.	—
	This unit cannot connect to the data server due to network error, etc.	Check the network settings, then contact the network connection provider.	—
<b>USB Connected</b>	A USB storage device is properly connected to this unit.		
<b>USB Disconnected</b>	The USB storage device is disconnected.	Connect the USB storage device securely.	6
<b>Access Denied</b>	The PC you are attempting to connect has denied connection.	Accept the YMC-700 on the “Media Sharing” screen of Windows Media Player 11.	25
<b>Unable to play</b>	This unit cannot play back the songs currently stored on your PC.	Make sure Windows Media Player 11 is installed on your PC.	—
		Check that the songs currently stored on your PC are playable (MP3, WMA, MPEG-4 AAC, and WAV).	—
		Store some other playable music files (MP3, WMA, MPEG-4 AAC, and WAV) on your PC.	—
	The network may be overloaded with heavy traffic, and playback is interrupted.	Try preparing a network exclusively for use with this unit to separate it from general network traffic.	—
<b>License Unavailable</b>	You are attempting to play back expired digital rights management (DRM) encrypted content.	Select a file that is not protected by DRM.	—
	Windows Media Player 11 does not acquire the DRM license for the file.	Acquire the license to play back the file on Windows Media Player 11.	—

## ■ iPod

### Note

If there is a transmission error but no status message appears on the GUI screen, check the connection of your iPod.

Status message	Cause	Remedy	See page
<b>Loading...</b>	This unit is in the process of recognizing the connection with your iPod.		
	This unit is in the process of acquiring song lists from your iPod.		
<b>Connect Error</b>	There is a problem with the signal path from your iPod to this unit.	Turn off this unit and reconnect the Yamaha iPod universal dock to the DOCK terminal of this unit.	7
		Try resetting your iPod.	—
<b>Unknown iPod</b>	The iPod being used is not supported by this unit.	This unit supports iPod touch, iPod (Click Wheel, including iPod classic), iPod nano and iPod mini.	—
<b>iPod Connected</b>	Your iPod is properly stationed in a Yamaha iPod universal dock (such as the YDS-11, sold separately) connected to the DOCK terminal of this unit, and the connection between your iPod and this unit is complete.		
<b>iPod Disconnected</b>	Your iPod was removed from a Yamaha iPod universal dock (such as the YDS-11, sold separately) connected to the DOCK terminal of this unit.	Station your iPod back in a Yamaha iPod universal dock (such as the YDS-11, sold separately) connected to the DOCK terminal of this unit.	7

## ■ Bluetooth

Status message	Cause
<b>Searching...</b>	The Bluetooth wireless audio receiver and the Bluetooth component are in the process of the pairing.
	The Bluetooth wireless audio receiver and the Bluetooth component are in the process of establishing the connection.
<b>Pairing Completed</b>	The pairing is completed.
<b>Pairing Canceled</b>	The pairing has been canceled.
<b>Bluetooth Connected</b>	The connection between the Yamaha Bluetooth wireless audio receiver (such as the YBA-10, sold separately) and the Bluetooth component is established.
<b>Bluetooth Disconnected</b>	The Bluetooth component is disconnected from the Yamaha Bluetooth wireless audio receiver (such as the YBA-10, sold separately).
<b>No Bluetooth Receiver</b>	The Bluetooth wireless audio receiver (such as the YBA-10, sold separately) is not connected to this unit.
<b>Bluetooth Receiver Error</b>	The Bluetooth wireless audio receiver has returned an error. Contact the nearest authorized Yamaha dealer or service center.

## ■ Auto Speaker Setup

If an error or warning message appears, check the cause of the problem, then perform the Auto Speaker Setup procedure again.

Error message	Cause	Remedy	See page
<b>E-1: NO FRONT SP</b>	Front L/R channel signals are not detected.	Check the front L/R speaker connections.	6
<b>E-2: NO SUR. SP</b>	No surround channel signals are detected.	Check the surround L/R speaker connections.	6
<b>E-3: NOISY</b>	Background noise is too loud.	Perform the Auto Speaker Setup in a quiet environment.	—
		Turn off noisy electric equipment like air conditioners or move them away from the YPAO Mic.	—
<b>E-4: NO MIC</b>	The YPAO Mic was unplugged during the “Auto Speaker Setup” procedure.	Connect the supplied YPAO Mic to the YPAO Mic jack.	11
<b>E-5: NO SIGNAL</b>	The YPAO Mic does not detect test tones.	Check the YPAO Mic setting.	11
		Check the speaker connections and placement.	6, 9
		The YPAO Mic or YPAO Mic jack may be defective. Contact the nearest Yamaha dealer or service center.	—
<b>E-6: USER CANCEL</b>	The “Auto Speaker Setup” procedure was cancelled due to user activity.	Perform the Auto Speaker Setup procedure again.	10
<b>E-7: INTERNAL ERROR</b>	An internal error occurred.	Perform the Auto Speaker Setup procedure again. If this error occurs repeatedly, contact a qualified Yamaha service center.	10

Warning message	Cause	Remedy	See page
<b>SWFR LEVEL ERROR</b>	The difference of volume level between speakers and subwoofer is excessive.	Adjust the volume of the subwoofer to compensate the status of “SWFR” on the results display.	10

# Glossary

## ■ AIR SURROUND XTREME

New Surround technology developed by Yamaha enables surround with fewer speakers. In comparison to traditional front surround technology, the AIR SURROUND XTREME provides a natural surround sound field.

## ■ Audio and video synchronization (lip sync)

Lip sync, an abbreviation for lip synchronization, is a technical term that involves both a problem and a capability of maintaining audio and video signals synchronized during post-production and transmission. Whereas the audio and video latency requires complex end-user adjustments, HDMI version 1.3 incorporates an automatic audio and video syncing capability that allows devices to perform this synchronization automatically and accurately without user interaction.

## ■ Component video signal

With the component video signal system, the video signal is separated into the Y signal for the luminance and the Pb and Pr signals for the chrominance. Color can be reproduced more faithfully with this system because each of these signals is independent. The component signal is also called the “color difference signal” because the luminance signal is subtracted from the color signal.

## ■ Composite video signal

With the composite video signal system, the video signal is composed of three basic elements of a video picture: color, brightness and synchronization data. A composite video jack on a video component transmits these three elements combined.

## ■ Deep Color

Deep Color refers to the use of various color depths in displays, up from the 24-bit depths in previous versions of the HDMI specification. This extra bit depth allows HDTVs and other displays go from millions of colors to billions of colors and eliminate on-screen color banding for smooth tonal transitions and subtle gradations between colors. The increased contrast ratio can represent many times more shades of gray between black and white. Also Deep Color increases the number of available colors within the boundaries defined by the RGB or YCbCr color space.

## ■ Dolby Digital

Dolby Digital is a digital surround sound system that gives you completely independent multi-channel audio. With 3 front channels (front L/R and center), and 2 surround stereo channels, Dolby Digital provides 5 full-range audio channels. With an additional channel especially for bass effects, called LFE (Low Frequency Effect), the system has a total of 5.1-channels (LFE is counted as 0.1 channel). By using 2-channel stereo for the surround speakers, more accurate moving sound effects and surround sound environment are possible. The wide dynamic range from maximum to minimum volume reproduced by the 5 full-range channels and the precise sound orientation generated using digital sound processing provide listeners with unprecedented excitement and realism. With this unit, any sound environment from monaural up to a 5.1-channel configuration can be freely selected for your enjoyment.

## ■ Dolby Digital Plus

Dolby Digital Plus is an advanced audio technology developed for high-definition programming and media including HD broadcasts and Blu-ray Disc. Selected as an optional audio standard for Blu-ray Disc, this technology delivers multichannel sound with discrete channel output. Supporting bitrates up to 6.0 Mbps, Dolby Digital Plus can carry up to 7.1 discrete audio channels simultaneously. Supported by HDMI version 1.3 and designed for the optical disc players and AV receivers/amplifiers of the future, Dolby Digital Plus also remains fully compatible with the existing multichannel audio systems that incorporate Dolby Digital.

## ■ Dolby TrueHD

Dolby TrueHD is an advanced lossless audio technology developed for high-definition disc-based media including Blu-ray Disc. Selected as an optional audio standard for Blu-ray Disc, this technology delivers sound that is bit-for-bit identical to the studio master, offering a high-definition home theater experience. Supporting bitrates up to 18.0 Mbps, Dolby TrueHD can carry up to 8 discrete channels of 24-bit/96 kHz audio simultaneously. Supported by HDMI version 1.3 and designed for the optical disc players and AV receivers/amplifiers of the future, Dolby TrueHD also remains fully compatible with the existing multichannel audio systems and retains the metadata capability of Dolby Digital, allowing dialog normalization and dynamic range control.

## ■ DTS 96/24

DTS 96/24 offers an unprecedented level of audio quality for multi-channel sound on DVD video, and is fully backward-compatible with all DTS decoders. “96” refers to a 96 kHz sampling rate compared to the typical 48 kHz sampling rate. “24” refers to 24-bit word length. DTS 96/24 offers sound quality transparent to the original 96/24 master, and 96/24 5.1-channel sound with full-quality full-motion video for music programs and motion picture soundtracks on DVD video.

## ■ DTS Digital Surround

DTS digital surround was developed to replace the analog soundtracks of movies with a 6.1-channel digital sound track. DTS, Inc. has developed a home theater system so that you can enjoy the depth of sound and natural spatial representation of DTS digital surround in your home. This system produces practically distortion-free 6-channel sound (technically, front left and right, center, surround left and right, and LFE 0.1 (subwoofer) channels for a total of 5.1 channels). This unit incorporates a DTS-ES decoder that enables 6.1-channel reproduction by adding the surround back channel to the existing 5.1-channel format.

## ■ FLAC

FLAC (Free Lossless Audio Codec) is an audio compression format.

FLAC uses lossless compression, allowing the signals to be compressed with absolutely no loss of the original sound’s data.

## ■ HDMI

HDMI (High-Definition Multimedia Interface) is the first industry-supported, uncompressed, all-digital audio/video interface. Providing an interface between any source (such as a set-top box or AV receiver) and an audio/video monitor (such as a digital television), HDMI supports standard, enhanced or high-definition video as well as multi-channel digital audio using a single cable. HDMI transmits all ATSC HDTV standards and supports 8-channel digital audio, with bandwidth to spare to accommodate future enhancements and requirements.

When used in combination with HDCP (High-bandwidth Digital Content Protection), HDMI provides a secure audio/video interface that meets the security requirements of content providers and system operators. For further information on HDMI, visit the HDMI website at “<http://www.hdmi.org/>”.

## ■ LFE 0.1 channel

This channel reproduces low-frequency signals. The frequency range of this channel is from 20 Hz to 120 Hz. This channel is counted as 0.1 because it only enforces a low-frequency range compared to the full-range reproduced by the other channels in systems.

## ■ MP3

One of the audio compression methods used by MPEG. It employs the irreversible compression method, which achieves a high compression rate by thinning out the data of hardly audible part to the human ears. It is said to be capable of compressing the data quantity by about 1/11 (128 kbps) while maintaining a similar audio quality to music CD.

## ■ MPEG-4 AAC

An MPEG-4 audio standard. As it allows compression of data at a bit rate lower than that of MPEG-2 AAC, it is used among others for mobile telephones, portable audio players and other low-capacity devices requiring high sound quality.

In addition to the above types of devices, MPEG-4 AAC is also used to distribute contents on the Internet, and as such is supported by computers, media servers and many other devices.

## ■ PCM (Linear PCM)

Linear PCM is a signal format under which an analog audio signal is digitized, recorded and transmitted without using any compression. The PCM system uses a technique for sampling the size of the analog signal per very small unit of time. Standing for “Pulse Code Modulation”, the analog signal is encoded as pulses and then modulated for recording.

## ■ Sampling frequency and number of quantized bits

When digitizing an analog audio signal, the number of times the signal is sampled per second is called the sampling frequency, while the degree of fineness when converting the sound level into a numeric value is called the number of quantized bits. The range of rates that can be played back is determined based on the sampling rate, while the dynamic range representing the sound level difference is determined by the number of quantized bits. In principle, the higher the sampling frequency, the wider the range of frequencies that can be played back, and the higher the number of quantized bits, the more finely the sound level can be reproduced.

## ■ WAV

Windows standard audio file format, which defines the method of recording the digital data obtained by converting audio signals. It does not specify the compression (coding) method so a desired compression method can be used with it. By default, it is compatible with the PCM method (no compression) and some compression methods including the ADPCM method.

## ■ WMA

An audio compression method developed by Microsoft Corporation. It employs the irreversible compression method, which achieves a high compression rate by thinning out the data of hardly audible part to the human ears. It is said to be capable of compressing the data quantity by about 1/22 (64 kbps) while maintaining a similar audio quality to music CD.

## ■ “x.v.Color”

A color space standard supported by HDMI version 1.3. It is a more extensive color space than sRGB, and allows the expression of colors that could not be expressed before. While remaining compatible with the color gamut of sRGB standards, “x.v.Color” expands the color space and can thus produce more vivid, natural images. It is particularly effective for still pictures and computer graphics.

## Information on audio/video jacks and cable plugs

This unit has three types of audio jacks, two types of video jacks and HDMI jacks. You can choose the connection method depending on the component to be connected.

### ■ Audio jacks

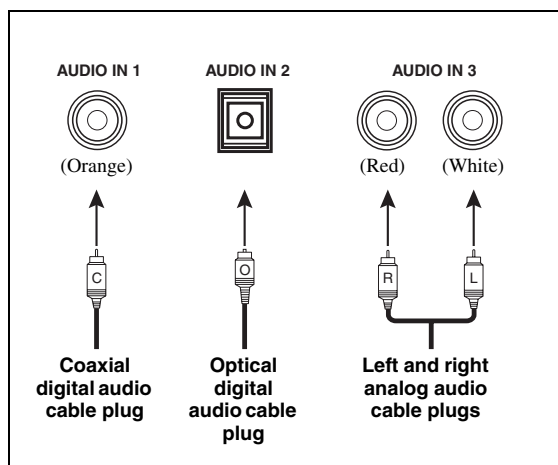

#### AUDIO IN 1 (COAXIAL) jack

For digital audio signals transmitted via a coaxial digital audio cable.

#### AUDIO IN 2 (OPTICAL) jack

For digital audio signals transmitted via an optical digital audio cable.

#### AUDIO IN 3 jacks

For conventional analog audio signals transmitted via a left and right analog audio cable. Connect the red plugs to the right jacks, the white plugs to the left jacks.

#### Note

You cannot use the AUDIO IN 3 jacks to input PCM, Dolby Digital and DTS bitstreams.

### ■ Video jacks

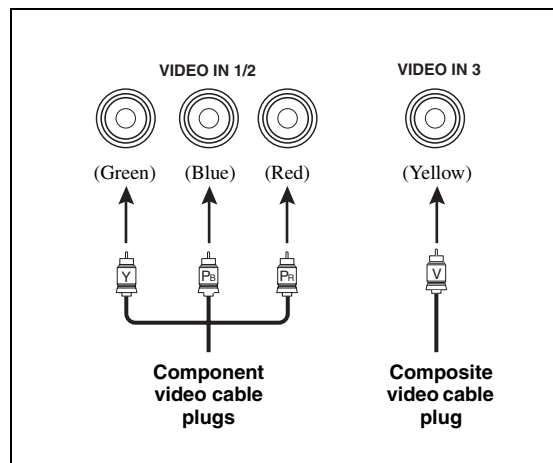

#### VIDEO IN 1/2 jacks

For component video signals, separated into the luminance (Y) and chrominance (PB, PR) video signals transmitted on separate wires of component video cables.

#### VIDEO IN 3 jack

For conventional composite video signals transmitted via composite video cable.



This unit is equipped with a video up-conversion function as shown below.

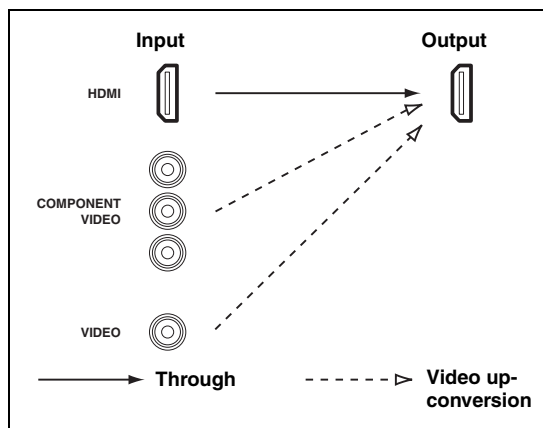

## Information on HDMI™

This unit has three HDMI input jacks and an HDMI output jack for digital audio and video signal input/output.

### ■ HDMI jack and cable plug

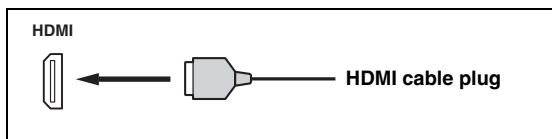

- We recommend that you use a commercially available HDMI cable shorter than 5 meters (16 feet) with the HDMI logo printed on it.
- Use a conversion cable (HDMI jack ↔ DVI-D jack) to connect this unit to other DVI components.
- If you set “HDMI Standby Through” in “Option” to “HDMI 1”, “HDMI 2” or “HDMI 3”, this unit allows the HDMI signals input at the corresponding HDMI IN jack to pass through this unit and be output from the HDMI OUT jack.

#### Notes

- Do not disconnect or connect the cable or turn off the power of the HDMI component connected to the HDMI OUT jack of this unit while data is being transferred. Doing so may disrupt playback or cause noise.
- The HDMI OUT jack outputs the audio signals input at the HDMI input jacks only.
- If you turn off the TV connected to the HDMI OUT jacks via a DVI connection, the connection may fail.

### ■ HDMI signal compatibility with this unit

#### Audio signals

Audio signal types	Audio signal formats	Compatible media
2ch Linear PCM	2ch, 32-192 kHz, 16/20/24 bit	CD, DVD-Video, DVD-Audio, etc.
Multi channel Linear PCM	8ch, 32-192 kHz, 16/20/24 bit	DVD-Audio, Blu-ray Disc, HD DVD, etc.
Bitstream	Dolby Digital, DTS	DVD-Video, Blu-ray Disc, HD DVD
Bitstream (High definition audio)	Dolby TrueHD, Dolby Digital Plus	Blu-ray Disc, HD DVD, etc.



Refer to the owner’s manual of the input source component and set the component appropriately.

#### Notes

- When CPPM copy-protected DVD audio is played back, video and audio signals may not be output, depending on the type of DVD player being used.
- This unit is not compatible with non HDCP compliant HDMI or DVI components.
- To decode bitstream audio signals on this unit, you may need to change some settings on the source component.

#### Video signals

This unit is compatible with video signals of the following resolutions:

- 480i/60 Hz
- 576i/50 Hz
- 480p/60 Hz
- 576p/50 Hz
- 720p/60 Hz, 50 Hz
- 1080i/60 Hz, 50 Hz
- 1080p/60 Hz, 50 Hz, 24Hz

#### Compatibility with Deep Color and x.v.Color video signals

This unit accepts Deep Color (30 or 36-bit) and x.v.Color video signals.

#### Note

If the TV is not compatible with Deep Color or x.v.Color video signals, the video source may not be played back correctly.

# Specifications

- Power Supply ..... AC 120 V, 60 Hz
- Power Consumption
  - YMC-700 ..... 60 W
  - YMC-500 ..... 50 W
- Standby Power Consumption (Reference Data) ..... 0.6 W
- Maximum Power Consumption
  - 5 ch, 10% THD ..... 170 W
- Dimensions (W x H x D) .....
  - YMC-700 ..... 298 x 93 x 332 mm (11-3/4" x 3-5/8" x 13-1/8")
  - YMC-500 ..... 298 x 93 x 313 mm (11-3/4" x 3-5/8" x 12-3/8")
- Weight ..... 3.6 kg (7.9 lbs)

\* Specifications are subject to change without notice.

## COMPLIANCE INFORMATION STATEMENT (DECLARATION OF CONFORMITY PROCEDURE)

Responsible Party: Yamaha Electronics Corporation, U.S.A.  
Address: 6660 Orangethorpe Avenue  
Buena Park, CA 90620  
Telephone: 714-522-9105  
1-800-492-6242 (toll free)  
Fax: 714-228-3390  
Type of Equipment: Media Controller  
Model Name: YMC-700/YMC-500

- This device complies with Part 15 of the FCC Rules.
  - Operation is subject to the following conditions:
    - This device may not cause harmful interference.
    - This device must accept any interference received including interference that may cause undesired operation.
- See the “Troubleshooting” section of this manual if interference to radio reception is suspected.

## We Want You Listening For A Lifetime



Yamaha and the Electronic Industries Association’s Consumer Electronics Group want you to get the most out of your equipment by playing it at a safe level. One that lets the sound come through loud and clear without annoying blaring or distortion – and, most importantly, without affecting your sensitive hearing. Since hearing damage from loud sounds is often undetectable until it is too late, Yamaha and the Electronic Industries Association’s Consumer Electronics Group recommend you to avoid prolonged exposure from excessive volume levels.



# Quick reference

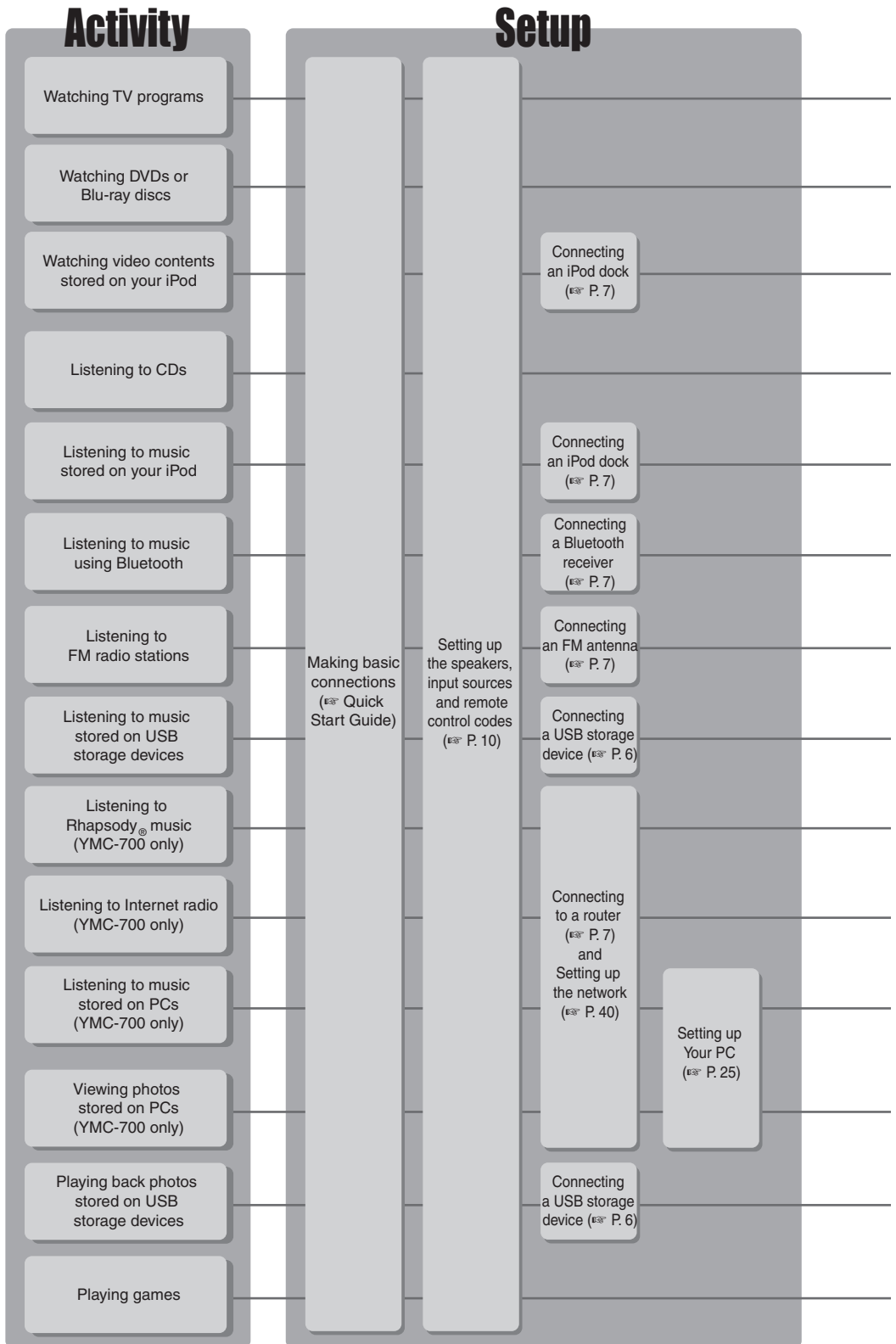

## Select input

## Control playback

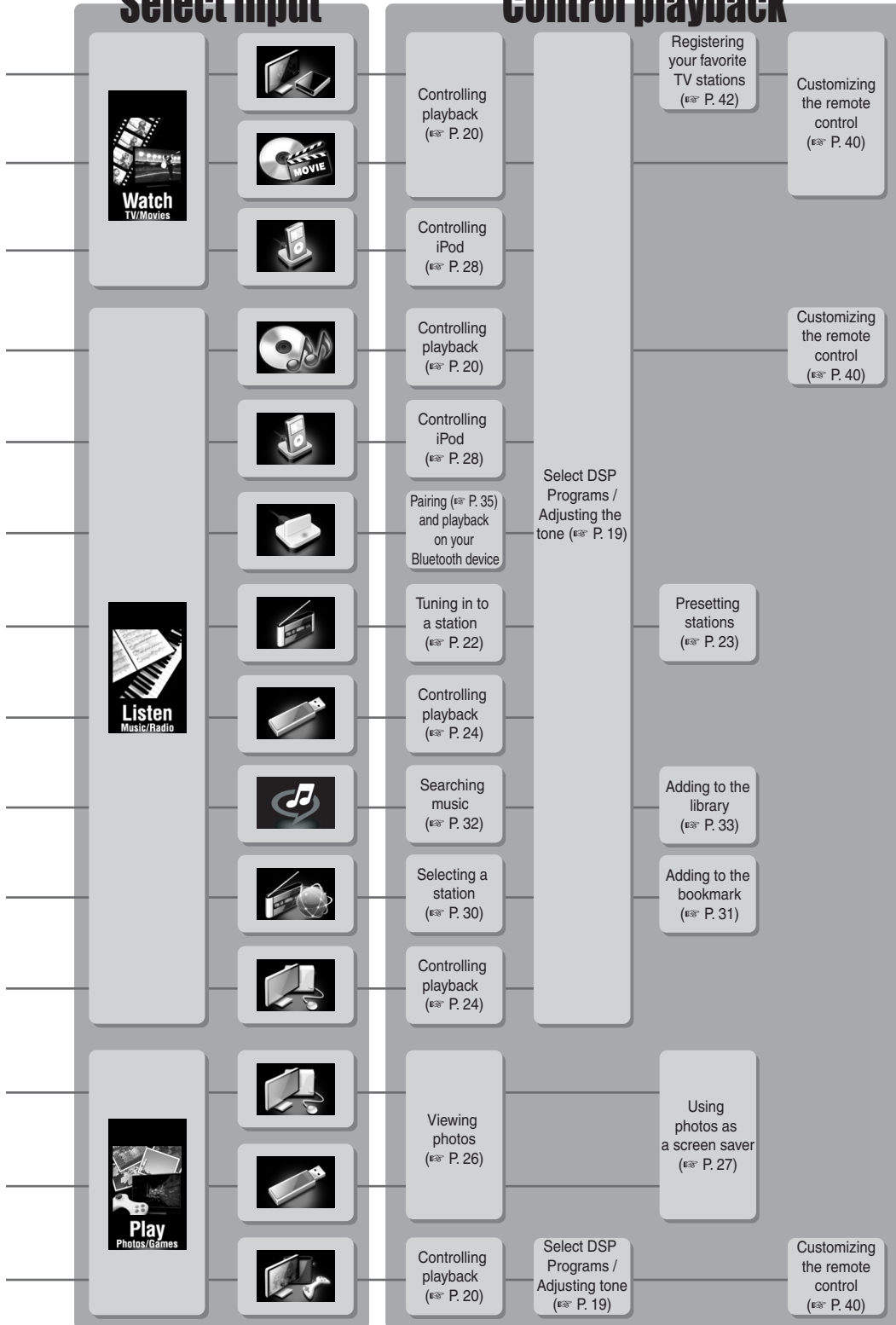

ADDITIONAL  
INFORMATION



© 2009 YAMAHA CORPORATION All rights reserved.

YAMAHA CORPORATION  
Printed in China © WR17640

# Read Me First

Use this guide to make sure all connections are properly done prior to powering the unit ON.

## YMC-700/YMC-500 Quick Start Guide

### Start

#### Items used for setup in this guide

- Supplied items**
- YMC-700/YMC-500 (this unit)
  - Power cable
  - Remote control
  - \* Install the supplied batteries to the remote control in advance.
  - IR flasher x2

#### Required items

- TV with an HDMI connection
- HDMI cable from this unit to TV
- Source devices (Cable box, DVD, etc.)
- HDMI and/or Audio/Video cables from source devices
- Speakers and speaker cables
- Subwoofer and subwoofer cable

For operation and installation details, refer to the owner's manual of each source device item.

1 On the "Connection Planning Chart [A]", write down the source devices (except TV) that you will connect in order of most frequently used (from left to right) as follows.

**A Connection Planning Chart**  
Use this chart to find the best possible connections.

The source device you will use most frequently

	Device 1	Device 2	Device 3
Write down the device you want to connect	Cable box	Game	Blu-ray
Video	HDMI 15 pt	HDMI 14 pt	HDMI 13 pt
Better	VIDEO 9 pt	VIDEO 9 pt	VIDEO 9 pt
Standard	VIDEO 3 pt	VIDEO 3 pt	VIDEO 3 pt
Audio	COAXIAL 3 pt	COAXIAL 3 pt	COAXIAL 3 pt
Better	OPTICAL 2 pt	OPTICAL 2 pt	OPTICAL 2 pt
Standard	AUDIO L/R 1 pt	AUDIO L/R 1 pt	AUDIO L/R 1 pt

2 View the output jacks available on each source device and then fill in the check box.

**A Connection Planning Chart**  
Use this chart to find the best possible connections.

The source device you will use most frequently

	Device 1	Device 2	Device 3
Write down the device you want to connect	Cable box	Game	Blu-ray
Video	HDMI 15 pt	HDMI 14 pt	HDMI 13 pt
Better	VIDEO 9 pt	VIDEO 9 pt	VIDEO 9 pt
Standard	VIDEO 3 pt	VIDEO 3 pt	VIDEO 3 pt
Audio	COAXIAL 3 pt	COAXIAL 3 pt	COAXIAL 3 pt
Better	OPTICAL 2 pt	OPTICAL 2 pt	OPTICAL 2 pt
Standard	AUDIO L/R 1 pt	AUDIO L/R 1 pt	AUDIO L/R 1 pt

3 Choose the best connections available for your source device as follows:

- When there is a check mark on the HDMI jack, circle the top HDMI 1, HDMI 2, or HDMI 3. If another previous device has already selected an input, then select the next one available.
- If there are NO check marks in any of the HDMI jacks, then make sure to select a video jack with an audio jack.

**A Connection Planning Chart**  
Use this chart to find the best possible connections.

The source device you will use most frequently

	Device 1	Device 2	Device 3
Write down the device you want to connect	Cable box	Game	Blu-ray
Video	HDMI 15 pt	HDMI 14 pt	HDMI 13 pt
Better	VIDEO 9 pt	VIDEO 9 pt	VIDEO 9 pt
Standard	VIDEO 3 pt	VIDEO 3 pt	VIDEO 3 pt
Audio	COAXIAL 3 pt	COAXIAL 3 pt	COAXIAL 3 pt
Better	OPTICAL 2 pt	OPTICAL 2 pt	OPTICAL 2 pt
Standard	AUDIO L/R 1 pt	AUDIO L/R 1 pt	AUDIO L/R 1 pt

4 Write down the total points (pt) of the circled item(s).

**A Connection Planning Chart**  
Use this chart to find the best possible connections.

The source device you will use most frequently

	Device 1	Device 2	Device 3
Write down the device you want to connect	Cable box	Game	Blu-ray
Video	HDMI 15 pt	HDMI 14 pt	HDMI 13 pt
Better	VIDEO 9 pt	VIDEO 9 pt	VIDEO 9 pt
Standard	VIDEO 3 pt	VIDEO 3 pt	VIDEO 3 pt
Audio	COAXIAL 3 pt	COAXIAL 3 pt	COAXIAL 3 pt
Better	OPTICAL 2 pt	OPTICAL 2 pt	OPTICAL 2 pt
Standard	AUDIO L/R 1 pt	AUDIO L/R 1 pt	AUDIO L/R 1 pt

5 Using the points, write down the names of the devices on the "Connection Diagrams [B]".

**B Connection Diagrams**

15 pt	12 pt	9 pt	6 pt	3 pt
14 pt	11 pt	8 pt	5 pt	2 pt
13 pt	10 pt	7 pt	4 pt	1 pt

6 Refer to "Connection Diagrams [B]" and then connect the cables from the source devices to this unit as indicated. See page 6 about further connections (iPod dock, network, etc.)

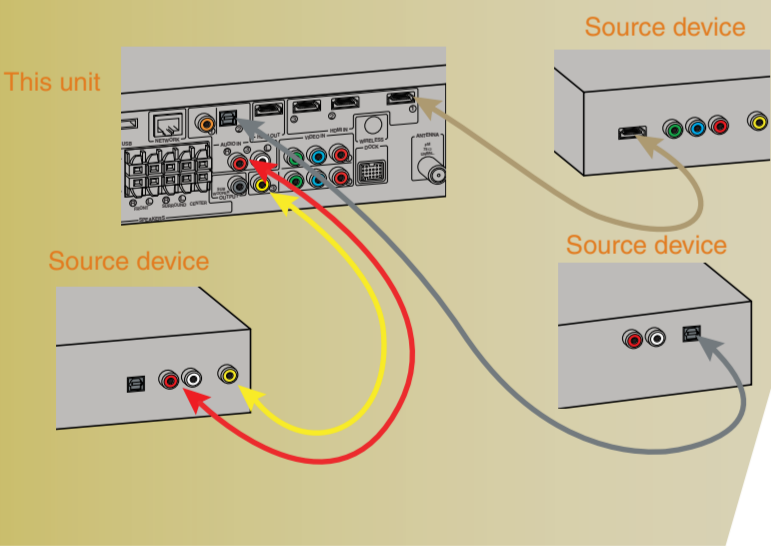

7 Use an HDMI cable to connect this unit to your TV's HDMI input.

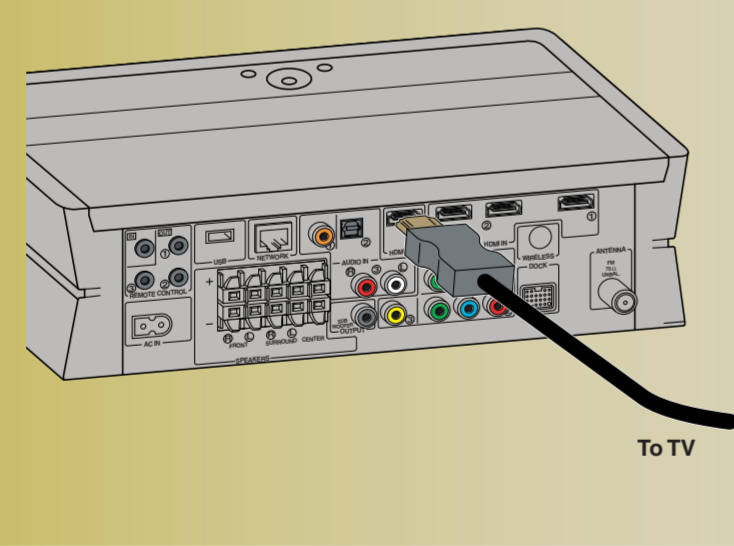

8 Connect the supplied IR flashers to the REMOTE OUT jacks on the back of this unit, then attach the IR flasher to the remote control sensor on the front of the devices as follows. (P. 8 for details) This will allow this unit to control the attached source devices.

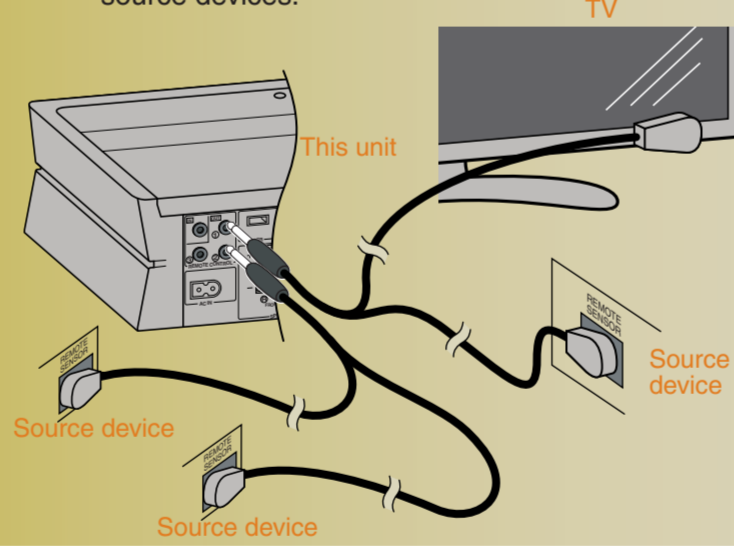

9 Connect speakers to the SPEAKERS terminals. If speakers have color coded terminals, match the colors. If the speakers are not color coded on the terminals, then match + and -. (P. 6 for details)

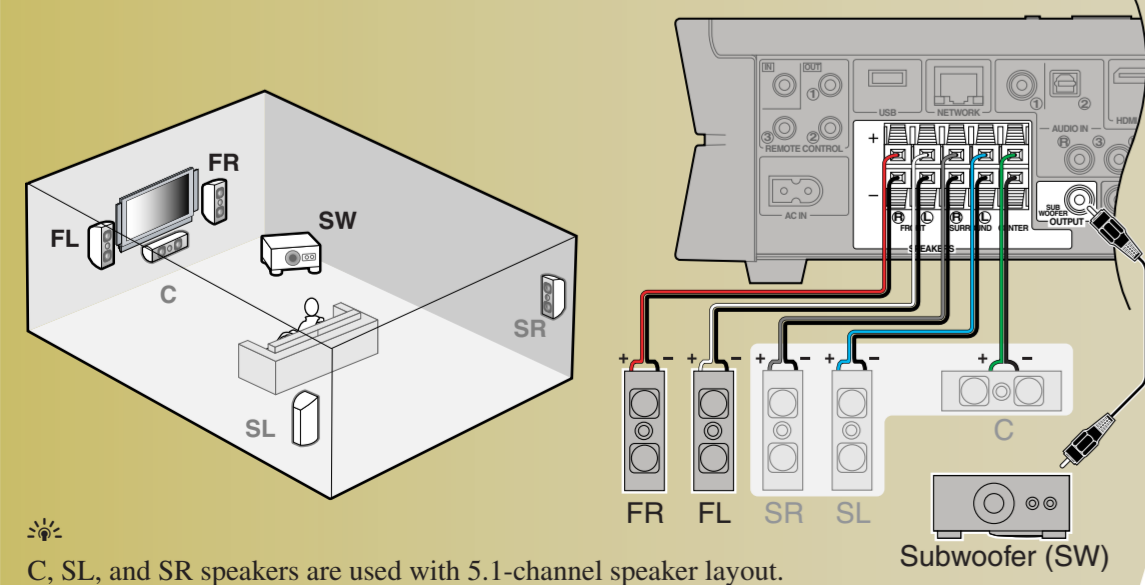

10

- Connect the power cable to this unit and plug it to a wall outlet.
- Turn all connected devices ON including this unit, subwoofer and TV. Make sure to select the appropriate HDMI input on the TV to display neoHD "Initial Setup" screen.
- Follow the setup process of this unit by using the "Initial Setup" on screen guide to complete the basic configuration. (P. 10)

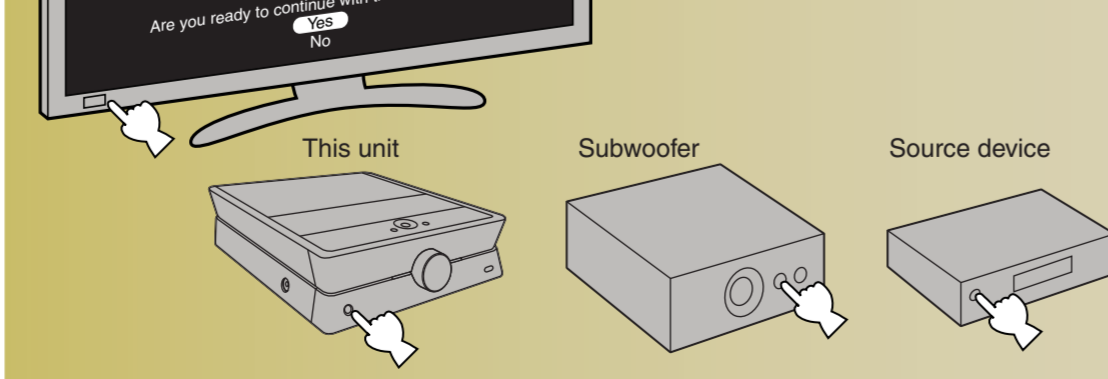

Begin the Initial Setup

### A Connection Planning Chart

Use this chart to find the best possible connections.

The source device you will use most frequently

	Device 1	Device 2	Device 3	Device 4	Device 5	Device 6
Write down the device you want to connect						
HDMI	HDMI 1 15 pt	HDMI 1 15 pt	HDMI 1 15 pt	HDMI 1 15 pt	HDMI 1 15 pt	HDMI 1 15 pt
Better	HDMI 2 14 pt	HDMI 2 14 pt	HDMI 2 14 pt	HDMI 2 14 pt	HDMI 2 14 pt	HDMI 2 14 pt
Standard	HDMI 3 13 pt	HDMI 3 13 pt	HDMI 3 13 pt	HDMI 3 13 pt	HDMI 3 13 pt	HDMI 3 13 pt
Video	VIDEO 1 9 pt	VIDEO 1 9 pt	VIDEO 1 9 pt	VIDEO 1 9 pt	VIDEO 1 9 pt	VIDEO 1 9 pt
Better	VIDEO 2 6 pt	VIDEO 2 6 pt	VIDEO 2 6 pt	VIDEO 2 6 pt	VIDEO 2 6 pt	VIDEO 2 6 pt
Standard	VIDEO 3 3 pt	VIDEO 3 3 pt	VIDEO 3 3 pt	VIDEO 3 3 pt	VIDEO 3 3 pt	VIDEO 3 3 pt
Audio	COAXIAL 3 pt	COAXIAL 3 pt	COAXIAL 3 pt	COAXIAL 3 pt	COAXIAL 3 pt	COAXIAL 3 pt
Better	OPTICAL 2 pt	OPTICAL 2 pt	OPTICAL 2 pt	OPTICAL 2 pt	OPTICAL 2 pt	OPTICAL 2 pt
Standard	AUDIO L/R 1 pt	AUDIO L/R 1 pt	AUDIO L/R 1 pt	AUDIO L/R 1 pt	AUDIO L/R 1 pt	AUDIO L/R 1 pt

Total pt of the circled items → 15 pt 12 pt 9 pt 6 pt 3 pt

The numbers of pts are used in the Initial Setup procedure.

### B Connection Diagrams

H: HDMI V: VIDEO A: AUDIO



Use the following cables for connections.

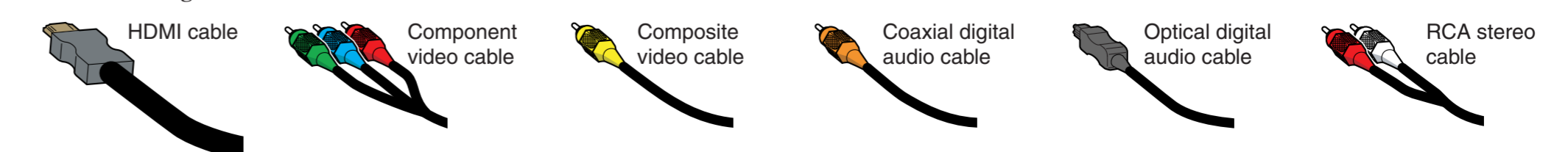

## IMPORTANT SAFETY INSTRUCTIONS

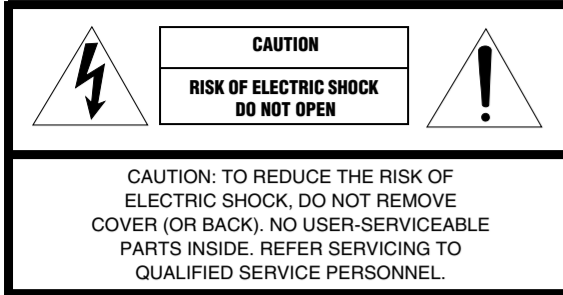

- Read these instructions.
- Keep these instructions.
- Heed all warnings.
- Follow all instructions.
- Do not use this apparatus near water.
- Clean only with dry cloth.
- Do not block any ventilation openings. Install in accordance with the manufacturer's instructions.
- Do not install near any heat sources such as radiators, heat registers, stoves, or other apparatus (including amplifiers) that produce heat.
- Do not defeat the safety purpose of the polarized or grounding-type plug. A polarized plug has two blades with one wider than the other. A grounding type plug has two blades and a third grounding prong. The wide blade or the third prong are provided for your safety. If the provided plug does not fit into your outlet, consult an electrician for replacement of the obsolete outlet.
- Protect the power cord from being walked on or pinched particularly at plugs, convenience receptacles, and the point where they exit from the apparatus.
- Only use attachments/accessories specified by the manufacturer.
- Use only with the cart, stand, tripod, bracket, or table specified by the manufacturer, or sold with the apparatus. When a cart is used, use caution when moving the cart/apparatus combination to avoid injury from tip-over.
- Unplug this apparatus during lightning storms or when unused for long periods of time.
- Refer all servicing to qualified service personnel. Servicing is required when the apparatus has been damaged in any way, such as power-supply cord or plug is damaged, liquid has been spilled or objects have fallen into the apparatus, the apparatus has been exposed to rain or moisture, does not operate normally, or has been dropped.

- Explanation of Graphical Symbols**  
The lightning flash with arrowhead symbol, within an equilateral triangle, is intended to alert you to the presence of unshielded "dangerous voltage" within the product's enclosure that may be of sufficient magnitude to constitute a risk of electric shock to persons.  
The exclamation point within an equilateral triangle is intended to alert you to the presence of important operating and maintenance (servicing) instructions in the literature accompanying the appliance.

**Note to CATV system installer:**  
This reminder is provided to call the CATV system installer's attention to Article 820-40 of the NEC that provides guidelines for proper grounding and, in particular, specifies that the cable ground shall be connected to the grounding system of the building, as close to the point of cable entry as practical.

## FCC INFORMATION (for US customers)

- IMPORTANT NOTICE: DO NOT MODIFY THIS UNIT!**  
This product, when installed as indicated in the instructions contained in this manual, meets FCC requirements. Modifications not expressly approved by Yamaha may void your authority, granted by the FCC, to use the product.  
**IMPORTANT:** When connecting this product to accessories and/or another product use only high quality shielded cables. Cable's supplied with this product MUST be used. Follow all installation instructions. Failure to follow instructions could void your FCC authorization to use this product in the USA.
  - NOTE:** This product has been tested and found to comply with the requirements listed in FCC Regulations, Part 15 for Class "B" digital devices. Compliance with these requirements provides a reasonable level of assurance that your use of this product in a residential environment will not result in harmful interference with other electronic devices.  
This equipment generates/uses radio frequencies and, if not installed and used according to the instructions found in the users manual, may cause interference harmful to the operation of other electronic devices.
- Compliance with FCC regulations does not guarantee that interference will not occur in all installations. If this product is found to be the source of interference, which can be determined by turning the unit "OFF" and "ON," please try to eliminate the problem by using one of the following measures:
- Relocate either this product or the device that is being affected by the interference.
  - Utilize power outlets that are on a different branch (circuit breaker or fuse) circuits or install AC line filters.
  - In the case of radio or TV interference, relocate/reorient the antenna. If the antenna lead-in is 300 ohm ribbon lead, change the lead-in to coaxial type cable.
  - If these corrective measures do not produce satisfactory results, please contact the local retailer authorized to distribute this type of product. If you can not locate the appropriate retailer, please contact Yamaha Electronics Corp., U.S.A. 6660 Orangeshorpe Ave, Buena Park, CA 90620.
- The above statements apply ONLY to those products distributed by Yamaha Corporation of America or its subsidiaries.

The following information applies for YMC-700 only.

## COMPLIANCE INFORMATION STATEMENT

This device complies with Part 15 of the FCC Rules and RSS-Gen of IC Rules. Operation is subject to the following two conditions:  
1) this device may not cause harmful interference, and  
2) this device must accept any interference received including interference that may cause undesired operation of this device. See user manual instructions if interference to radio reception is suspected.

This equipment complies with FCC/IC radiation exposure limits set forth for uncontrolled equipment and meets the FCC radio frequency (RF) Exposure Guidelines in Supplement C to OET65 and RSS-102 of the IC radio frequency (RF) Exposure rules. This equipment should be installed and operated with at least 20 cm and more between the radiator and person's body (excluding extremities: hands, wrists, feet and ankles).

### NOTICE

This equipment has been tested and found to comply with the limits for a Class B digital device, pursuant to part 15 of the FCC Rules. These limits are designed to provide reasonable protection against harmful interference in a residential installation. This equipment generates, uses and can radiate radio frequency energy and, if not installed and used in accordance with the instructions, may cause harmful interference to radio communications. However, there is no guarantee that interference will not occur in a particular installation. If this equipment does cause harmful interference to radio or television reception, which can be determined by turning the equipment off and on, the user is encouraged to try to correct the interference by one or more of the following measures:  
- Reorient or relocate the receiving antenna.  
- Increase the separation between the equipment and receiver.  
- Connect the equipment into an outlet on a circuit different from that to which the receiver is connected.  
- Consult the dealer or an experienced radio/TV technician for help.

### FCC WARNING

Change or modifications not expressly approved by the party responsible for compliance could void the user's authority to operate the equipment.

This transmitter must not be co-located or operated in conjunction with any other antenna or transmitter.

### Precautions

#### Read this before using this unit.

- To assure the finest performance, please read this manual carefully. Keep it in a safe place for future reference.
- Install this unit in a cool, dry, clean place away from direct sunlight, heat sources, and sources of excessive vibration, dust, moisture, and/or cold. (Do not use/keep this unit in a car etc.)
  - Locate this unit away from other electrical appliances, motors, or transformers to avoid humming sounds.
  - Do not expose this unit to sudden temperature changes from cold to hot, and do not locate this unit in an environment with high humidity (i.e. a room with a humidifier) to prevent condensation inside this unit, which may cause an electrical shock, fire, damage to this unit, and/or personal injury.
  - Do not clean this unit with chemical solvents; this might damage the finish. Use a clean, dry cloth.
  - Do not attempt to modify or fix this unit. Contact qualified Yamaha service personnel when any service is needed. The cabinet should never be opened for any reason.
  - Be sure to read the "Troubleshooting" section regarding common operating errors before concluding that the unit is faulty.

If there should be color blotching or noise when used near a TV, move this unit away from the TV when using it.

Do not use this unit within 22 cm (9 inches) of persons with a heart pacemaker implant or defibrillator implant.

We, the manufacturer Yamaha hereby declare that the YMC-700 is in compliance with the essential requirements and other relevant provisions of Directive 1999/5/EC.

The user shall not reverse engineer, decompile, alter, translate or disassemble the software used in this unit, whether in part or in whole. For corporate users, employees of the corporation itself as well as its business partners shall observe the contractual bans stipulated within this clause. If the stipulations of this clause and this contract cannot be observed, the user shall immediately discontinue using the software.

## Caution: Read this before operating your unit.

- To assure the finest performance, please read this manual carefully. Keep it in a safe place for future reference.
- Install this sound system in a well ventilated, cool, dry, clean place – away from direct sunlight, heat sources, vibration, dust, moisture, and/or cold. Allow ventilation space of at least 10 cm on the top, 5 cm on the left and right, and 5 cm on the back of this unit.
- Locate this unit away from other electrical appliances, motors, or transformers to avoid humming sounds.
- Do not expose this unit to sudden temperature changes from cold to hot, and do not locate this unit in an environment with high humidity (i.e. a room with a humidifier) to prevent condensation inside this unit, which may cause an electrical shock, fire, damage to this unit, and/or personal injury.
- Avoid installing this unit where foreign objects may fall onto this unit and/or this unit may be exposed to liquid dripping or splashing. On the top of this unit, do not place:
  - Other components, as they may cause damage and/or discoloration on the surface of this unit.
  - Burning objects (i.e. candles), as they may cause fire, damage to this unit, and/or personal injury.
  - Containers with liquid in them, as they may fall and liquid may cause electrical shock to the user and/or damage to this unit.
- Do not cover this unit with a newspaper, tablecloth, curtain, etc. in order not to obstruct heat radiation. If the temperature inside this unit rises, it may cause fire, damage to this unit, and/or personal injury.
- Do not plug in this unit to a wall outlet until all connections are complete.
- Do not operate this unit upside-down. It may overheat, possibly causing damage.
- Do not use force on switches, knobs and/or cords.
- When disconnecting the power cable from the wall outlet, grasp the plug; do not pull the cable.
- Do not clean this unit with chemical solvents; this might damage the finish. Use a clean, dry cloth.
- Only voltage specified on this unit must be used. Using this unit with a higher voltage than specified is dangerous and may cause fire, damage to this unit, and/or personal injury. Yamaha will not be held responsible for any damage resulting from use of this unit with a voltage other than specified.
- To prevent damage by lightning, keep the power cord and outdoor antennas disconnected from a wall outlet or the unit during a lightning storm.
- Do not attempt to modify or fix this unit. Contact qualified Yamaha service personnel when any service is needed. The cabinet should never be opened for any reasons.
- When not planning to use this unit for long periods of time (i.e. vacation), disconnect the AC power plug from the wall outlet.
- Install this unit near the AC outlet and where the AC power plug can be reached easily.
- Be sure to read the "Troubleshooting" section on common operating errors before concluding that this unit is faulty.
- Before moving this unit, press **Q** to set this unit to the standby mode, and disconnect the AC power plug from the AC wall outlet.

- The batteries shall not be exposed to excessive heat such as sunshine, fire or like.
- When replacing the batteries, be sure to use batteries of the same type. Danger of explosion may happen if batteries are incorrectly replaced.

**WARNING**  
TO REDUCE THE RISK OF FIRE OR ELECTRIC SHOCK, DO NOT EXPOSE THIS UNIT TO RAIN OR MOISTURE.

As long as this unit is connected to the AC wall outlet, it is not disconnected from the AC power source even if you turn off this unit by **Q**. In this state, this unit is designed to consume a very small quantity of power.

### FOR CANADIAN CUSTOMERS

To prevent electric shock, match wide blade of plug to wide slot and fully insert.  
This Class B digital apparatus complies with Canadian ICES-003.

### IMPORTANT

Please record the serial number of this unit in the space below.  
**MODEL:**  
**Serial No.:**  
The serial number is located on the bottom of the unit. Retain this guide and Owner's Manual in a safe place for future reference.

The label is located on the bottom of this unit.

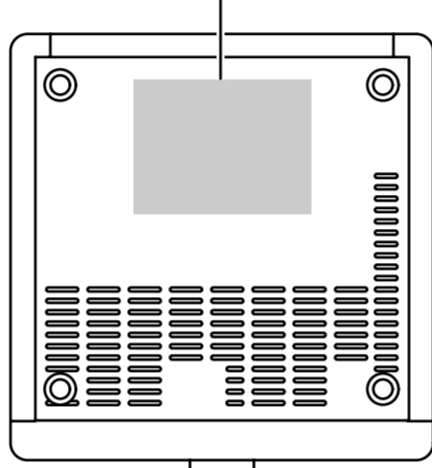

## Information about free software

This product uses the following free software.  
For information (copyright, etc) about each software, read the original sentences stated below.

### About curl

**COPYRIGHT AND PERMISSION NOTICE**  
Copyright (c) 1996 - 2007, Daniel Stenberg, <daniel@haxx.se>.  
All rights reserved. Permission to use, copy, modify, and distribute this software for any purpose with or without fee is hereby granted, provided that the above copyright notice and this permission notice appear in all copies.  
THE SOFTWARE IS PROVIDED "AS IS", WITHOUT WARRANTY OF ANY KIND, EXPRESS OR IMPLIED, INCLUDING BUT NOT LIMITED TO THE WARRANTIES OF MERCHANTABILITY, FITNESS FOR A PARTICULAR PURPOSE AND NONINFRINGEMENT OF THIRD PARTY RIGHTS. IN NO EVENT SHALL THE AUTHORS OR COPYRIGHT HOLDERS BE LIABLE FOR ANY CLAIM, DAMAGES OR OTHER LIABILITY, WHETHER IN AN ACTION OF CONTRACT, TORT OR OTHERWISE, ARISING FROM, OUT OF OR IN CONNECTION WITH THE SOFTWARE OR THE USE OR OTHER DEALINGS IN THE SOFTWARE.  
Except as contained in this notice, the name of a copyright holder shall not be used in advertising or otherwise to promote the sale, use or other dealings in this software without prior written authorization of the copyright holder.  
Copyright (c) 1995, 1996, 1997, 1998, 1999 Kingliga Tekniska Hogskolan (Royal Institute of Technology, Stockholm, Sweden).  
Copyright (c) 2004 - 2007 Daniel Stenberg  
Redistribution and use in source and binary forms, with or without modification, are permitted provided that the following conditions are met:  
1. Redistributions of source code must retain the above copyright notice, this list of conditions and the following disclaimer.  
2. Redistributions in binary form must reproduce the above copyright notice, this list of conditions and the following disclaimer in the documentation and/or other materials provided with the distribution.  
3. Neither the name of the Institute nor the names of its contributors may be used to endorse or promote products derived from this software without specific prior written permission.  
THIS SOFTWARE IS PROVIDED BY THE INSTITUTE AND CONTRIBUTORS "AS IS" AND ANY EXPRESS OR IMPLIED WARRANTIES, INCLUDING, BUT NOT LIMITED TO, THE IMPLIED WARRANTIES OF MERCHANTABILITY AND FITNESS FOR A PARTICULAR PURPOSE ARE DISCLAIMED. IN NO EVENT SHALL THE INSTITUTE OR CONTRIBUTORS BE LIABLE FOR ANY DIRECT, INDIRECT, INCIDENTAL, SPECIAL, EXEMPLARY, OR CONSEQUENTIAL DAMAGES (INCLUDING, BUT NOT LIMITED TO, PROCUREMENT OF SUBSTITUTE GOODS OR SERVICES; LOSS OF USE, DATA, OR PROFITS; OR BUSINESS INTERRUPTION) HOWEVER CAUSED AND ON ANY THEORY OF LIABILITY, WHETHER IN CONTRACT, STRICT LIABILITY, OR TORT (INCLUDING NEGLIGENCE OR OTHERWISE) ARISING IN ANY WAY OUT OF THE USE OF THIS SOFTWARE, EVEN IF ADVISED OF THE POSSIBILITY OF SUCH DAMAGE.

### About twip

Copyright (c) 2001, 2002 Swedish Institute of Computer Science.  
Copyright (c) 2001-2004 Leon Woestenberg <leon.woestenberg@gmx.net>  
Copyright (c) 2003-2004 Axon Digital Design B.V., The Netherlands.  
All rights reserved.  
Redistribution and use in source and binary forms, with or without modification, are permitted provided that the following conditions are met:  
1. Redistributions of source code must retain the above copyright notice, this list of conditions and the following disclaimer.  
2. Redistributions in binary form must reproduce the above copyright notice, this list of conditions and the following disclaimer in the documentation and/or other materials provided with the distribution.  
3. The name of the author may not be used to endorse or promote products derived from this software without specific prior written permission.  
THIS SOFTWARE IS PROVIDED BY THE AUTHOR "AS IS" AND ANY EXPRESS OR IMPLIED WARRANTIES, INCLUDING, BUT NOT LIMITED TO, THE IMPLIED WARRANTIES OF MERCHANTABILITY AND FITNESS FOR A PARTICULAR PURPOSE ARE DISCLAIMED. IN NO EVENT SHALL THE AUTHOR BE LIABLE FOR ANY DIRECT, INDIRECT, INCIDENTAL, SPECIAL, EXEMPLARY, OR CONSEQUENTIAL DAMAGES (INCLUDING, BUT NOT LIMITED TO, PROCUREMENT OF SUBSTITUTE GOODS OR SERVICES; LOSS OF USE, DATA, OR PROFITS; OR BUSINESS INTERRUPTION) HOWEVER CAUSED AND ON ANY THEORY OF LIABILITY, WHETHER IN CONTRACT, STRICT LIABILITY, OR TORT (INCLUDING NEGLIGENCE OR OTHERWISE) ARISING IN ANY WAY OUT OF THE USE OF THIS SOFTWARE, EVEN IF ADVISED OF THE POSSIBILITY OF SUCH DAMAGE.

### Copyright (c) 2002 CITEL Technologies Ltd. All rights reserved.

Redistribution and use in source and binary forms, with or without modification, are permitted provided that the following conditions are met:  
1. Redistributions of source code must retain the above copyright notice, this list of conditions and the following disclaimer.  
2. Redistributions in binary form must reproduce the above copyright notice, this list of conditions and the following disclaimer in the documentation and/or other materials provided with the distribution.  
3. Neither the name of CITEL Technologies Ltd nor the names of its contributors may be used to endorse or promote products derived from this software without specific prior written permission.

THIS SOFTWARE IS PROVIDED BY CITEL TECHNOLOGIES AND CONTRIBUTORS "AS IS" AND ANY EXPRESS OR IMPLIED WARRANTIES, INCLUDING, BUT NOT LIMITED TO, THE IMPLIED WARRANTIES OF MERCHANTABILITY AND FITNESS FOR A PARTICULAR PURPOSE ARE DISCLAIMED. IN NO EVENT SHALL CITEL TECHNOLOGIES OR CONTRIBUTORS BE LIABLE FOR ANY DIRECT, INDIRECT, INCIDENTAL, SPECIAL, EXEMPLARY, OR CONSEQUENTIAL DAMAGES (INCLUDING, BUT NOT LIMITED TO, PROCUREMENT OF SUBSTITUTE GOODS OR SERVICES; LOSS OF USE, DATA, OR PROFITS; OR BUSINESS INTERRUPTION) HOWEVER CAUSED AND ON ANY THEORY OF LIABILITY, WHETHER IN CONTRACT, STRICT LIABILITY, OR TORT (INCLUDING NEGLIGENCE OR OTHERWISE) ARISING IN ANY WAY OUT OF THE USE OF THIS SOFTWARE, EVEN IF ADVISED OF THE POSSIBILITY OF SUCH DAMAGE.

### Copyright (c) 2003 by Marc Boucher, Services Informatiques (MBSI) inc.

Copyright (c) 1997, 1998 by Global Election Systems Inc. All rights reserved.  
Copyright (c) 2001 by Cognizant Pty Ltd.  
The authors hereby grant permission to use, copy, modify, distribute, and license this software and its documentation for any purpose, provided that existing copyright notices are retained in all copies and that this notice and the following disclaimer are included verbatim in any distributions. No written agreement, license, or royalty fee is required for any of the authorized uses.

THIS SOFTWARE IS PROVIDED BY THE CONTRIBUTORS "AS IS" AND ANY EXPRESS OR IMPLIED WARRANTIES, INCLUDING, BUT NOT LIMITED TO, THE IMPLIED WARRANTIES OF MERCHANTABILITY AND FITNESS FOR A PARTICULAR PURPOSE ARE DISCLAIMED. IN NO EVENT SHALL THE CONTRIBUTORS BE LIABLE FOR ANY DIRECT, INDIRECT, INCIDENTAL, SPECIAL, EXEMPLARY, OR CONSEQUENTIAL DAMAGES (INCLUDING, BUT NOT LIMITED TO, PROCUREMENT OF SUBSTITUTE GOODS OR SERVICES; LOSS OF USE, DATA, OR PROFITS; OR BUSINESS INTERRUPTION) HOWEVER CAUSED AND ON ANY THEORY OF LIABILITY, WHETHER IN CONTRACT, STRICT LIABILITY, OR TORT (INCLUDING NEGLIGENCE OR OTHERWISE) ARISING IN ANY WAY OUT OF THE USE OF THIS SOFTWARE, EVEN IF ADVISED OF THE POSSIBILITY OF SUCH DAMAGE.

### Copyright (c) 1993, 1994 The Australian National University. All rights reserved.

Redistribution and use in source and binary forms are permitted provided that the above copyright notice and this paragraph are duplicated in all such forms and that any documentation, advertising materials, and other materials related to such distribution and use acknowledge that the software was developed by the Australian National University. The name of the University may not be used to endorse or promote products derived from this software without specific prior written permission.

THIS SOFTWARE IS PROVIDED "AS IS" AND WITHOUT ANY EXPRESS OR IMPLIED WARRANTIES, INCLUDING, WITHOUT LIMITATION, THE IMPLIED WARRANTIES OF MERCHANTABILITY AND FITNESS FOR A PARTICULAR PURPOSE.

### Copyright (c) 1989 Carnegie Mellon University. All rights reserved.

Redistribution and use in source and binary forms are permitted provided that the above copyright notice and this paragraph are duplicated in all such forms and that any documentation, advertising materials, and other materials related to such distribution and use acknowledge that the software was developed by Carnegie Mellon University. The name of the University may not be used to endorse or promote products derived from this software without specific prior written permission.

THIS SOFTWARE IS PROVIDED "AS IS" AND WITHOUT ANY EXPRESS OR IMPLIED WARRANTIES, INCLUDING, WITHOUT LIMITATION, THE IMPLIED WARRANTIES OF MERCHANTABILITY AND FITNESS FOR A PARTICULAR PURPOSE.

### Copyright (c) 1991 Gregory M. Christy. All rights reserved.

Redistribution and use in source and binary forms are permitted provided that the above copyright notice and this paragraph are duplicated in all such forms and that any documentation, advertising materials, and other materials related to such distribution and use acknowledge that the software was developed by Gregory M. Christy. The name of the author may not be used to endorse or promote products derived from this software without specific prior written permission.

THIS SOFTWARE IS PROVIDED "AS IS" AND WITHOUT ANY EXPRESS OR IMPLIED WARRANTIES, INCLUDING, WITHOUT LIMITATION, THE IMPLIED WARRANTIES OF MERCHANTABILITY AND FITNESS FOR A PARTICULAR PURPOSE.

### Copyright (c) 1995 Eric Rosenquist, Strata Software Limited. http://www.strataware.com/ All rights reserved.

Redistribution and use in source and binary forms are permitted provided that the above copyright notice and this paragraph are duplicated in all such forms and that any documentation, advertising materials, and other materials related to such distribution and use acknowledge that the software was developed by Eric Rosenquist. The name of the author may not be used to endorse or promote products derived from this software without specific prior written permission.

THIS SOFTWARE IS PROVIDED "AS IS" AND WITHOUT ANY EXPRESS OR IMPLIED WARRANTIES, INCLUDING, WITHOUT LIMITATION, THE IMPLIED WARRANTIES OF MERCHANTABILITY AND FITNESS FOR A PARTICULAR PURPOSE.

### Copyright (C) 1990, RSA Data Security, Inc. All rights reserved.

License to copy and use this software is granted provided that it is identified as the "RSA Data Security, Inc. MD5 Message-Digest Algorithm" in all material mentioning or referencing this software or this function.  
License is also granted to make and use derivative works provided that such works are identified as "derived from the RSA Data Security, Inc. MD5 Message-Digest Algorithm" in all material mentioning or referencing the derived work.  
RSA Data Security, Inc. makes no representations concerning either the merchantability of this software or the suitability of this software for any particular purpose. It is provided "AS IS" without express or implied warranty of any kind.  
These notices must be retained in any copies of any part of this documentation and/or software.

### Copyright (c) 1989 Regents of the University of California. All rights reserved.

Redistribution and use in source and binary forms are permitted provided that the above copyright notice and this paragraph are duplicated in all such forms and that any documentation, advertising materials, and other materials related to such distribution and use acknowledge that the software was developed by the University of California, Berkeley. The name of the University may not be used to endorse or promote products derived from this software without specific prior written permission.

THIS SOFTWARE IS PROVIDED "AS IS" AND WITHOUT ANY EXPRESS OR IMPLIED WARRANTIES, INCLUDING, WITHOUT LIMITATION, THE IMPLIED WARRANTIES OF MERCHANTABILITY AND FITNESS FOR A PARTICULAR PURPOSE.

## About OpenSSL

**LICENSE ISSUES**  
The OpenSSL toolkit stays under a dual license, i.e. both the conditions of the OpenSSL License and the original SSLeay license apply to the toolkit. See below for the actual license texts. Actually both licenses are BSD-style Open Source licenses. In case of any license issues related to OpenSSL, please contact openssl-core@openssl.org.  
OpenSSL License  
Copyright (c) 1998-2007 The OpenSSL Project. All rights reserved.

Redistribution and use in source and binary forms, with or without modification, are permitted provided that the following conditions are met:  
1. Redistributions of source code must retain the above copyright notice, this list of conditions and the following disclaimer.  
2. Redistributions in binary form must reproduce the above copyright notice, this list of conditions and the following disclaimer in the documentation and/or other materials provided with the distribution.  
3. All advertising materials mentioning features or use of this software must display the following acknowledgment:  
"This product includes software developed by the OpenSSL Project for use in the OpenSSL Toolkit. (http://www.openssl.org/)"  
4. The names "OpenSSL Toolkit" and "OpenSSL Project" must not be used to endorse or promote products derived from this software without prior written permission. For written permission, please contact openssl-core@openssl.org.  
5. Products derived from this software must not be called "OpenSSL" nor may "OpenSSL" appear in their names without prior written permission of the OpenSSL Project.  
6. Redistributions of any form whatsoever must retain the following acknowledgment:  
"This product includes software developed by the OpenSSL Project for use in the OpenSSL Toolkit (http://www.openssl.org/)"

THIS SOFTWARE IS PROVIDED BY THE OPENSSL PROJECT "AS IS" AND ANY EXPRESS OR IMPLIED WARRANTIES, INCLUDING, BUT NOT LIMITED TO, THE IMPLIED WARRANTIES OF MERCHANTABILITY AND FITNESS FOR A PARTICULAR PURPOSE ARE DISCLAIMED. IN NO EVENT SHALL THE OPENSSL PROJECT OR ITS CONTRIBUTORS BE LIABLE FOR ANY DIRECT, INDIRECT, INCIDENTAL, SPECIAL, EXEMPLARY, OR CONSEQUENTIAL DAMAGES (INCLUDING, BUT NOT LIMITED TO, PROCUREMENT OF SUBSTITUTE GOODS OR SERVICES; LOSS OF USE, DATA, OR PROFITS; OR BUSINESS INTERRUPTION) HOWEVER CAUSED AND ON ANY THEORY OF LIABILITY, WHETHER IN CONTRACT, STRICT LIABILITY, OR TORT (INCLUDING NEGLIGENCE OR OTHERWISE) ARISING IN ANY WAY OUT OF THE USE OF THIS SOFTWARE, EVEN IF ADVISED OF THE POSSIBILITY OF SUCH DAMAGE.

This product includes cryptographic software written by Eric Young (eay@cryptsoft.com). This product includes software written by Tim Hudson (tjh@cryptsoft.com).  
Original SSLeay License  
Copyright (c) 1995-1998 Eric Young (eay@cryptsoft.com)  
All rights reserved.

This package is an SSL implementation written by Eric Young (eay@cryptsoft.com). The implementation was written so as to conform to Netscape's SSL.  
This library is free for commercial and non-commercial use as long as the following conditions are abeared to. The following conditions apply to all code found in this distribution, be it the RC4, RSA, lhash, DES, etc., code; not just the SSL code. The SSL documentation included with this distribution is covered by the same copyright terms except that the holder is Tim Hudson (tjh@cryptsoft.com).  
Copyright remains Eric Young's, and as such any Copyright notices in the code are not to be removed. If this package is used in a product, Eric Young should be given attribution as the author of the parts of the library used. This can be in the form of a textual message at program startup or in documentation (online or physical) provided with the package.  
Redistribution and use in source and binary forms, with or without modification, are permitted provided that the following conditions are met:  
1. Redistributions of source code must retain the above copyright notice, this list of conditions and the following disclaimer.  
2. Redistributions in binary form must reproduce the above copyright notice, this list of conditions and the following disclaimer in the documentation and/or other materials provided with the distribution.  
3. All advertising materials mentioning features or use of this software must display the following acknowledgment:  
"This product includes cryptographic software written by Eric Young (eay@cryptsoft.com)"  
The word "cryptographic" can be left out of the routines from the library being used are not cryptographic related :-).  
4. If you include any Windows specific code (or a derivative thereof) from the apps directory (application code) you must include an acknowledgement:  
"This product includes software written by Tim Hudson (tjh@cryptsoft.com)"

THIS SOFTWARE IS PROVIDED BY ERIC YOUNG "AS IS" AND ANY EXPRESS OR IMPLIED WARRANTIES, INCLUDING, BUT NOT LIMITED TO, THE IMPLIED WARRANTIES OF MERCHANTABILITY AND FITNESS FOR A PARTICULAR PURPOSE ARE DISCLAIMED. IN NO EVENT SHALL THE AUTHOR OR CONTRIBUTORS BE LIABLE FOR ANY DIRECT, INDIRECT, INCIDENTAL, SPECIAL, EXEMPLARY, OR CONSEQUENTIAL DAMAGES (INCLUDING, BUT NOT LIMITED TO, PROCUREMENT OF SUBSTITUTE GOODS OR SERVICES; LOSS OF USE, DATA, OR PROFITS; OR BUSINESS INTERRUPTION) HOWEVER CAUSED AND ON ANY THEORY OF LIABILITY, WHETHER IN CONTRACT, STRICT LIABILITY, OR TORT (INCLUDING NEGLIGENCE OR OTHERWISE) ARISING IN ANY WAY OUT OF THE USE OF THIS SOFTWARE, EVEN IF ADVISED OF THE POSSIBILITY OF SUCH DAMAGE.

The license and distribution terms for any publicly available version or derivative of this code cannot be changed. I.e. this code cannot simply be copied and put under another distribution license (including the GNU Public License.)

### About FLAC codec library

Copyright (C) 2000,2001,2002,2003,2004 Josh Coulson

Redistribution and use in source and binary forms, with or without modification, are permitted provided that the following conditions are met:  
- Redistributions of source code must retain the above copyright notice, this list of conditions and the following disclaimer.  
- Redistributions in binary form must reproduce the above copyright notice, this list of conditions and the following disclaimer in the documentation and/or other materials provided with the distribution.  
- Neither the name of the Xiph.org Foundation nor the names of its contributors may be used to endorse or promote products derived from this software without specific prior written permission.

THIS SOFTWARE IS PROVIDED BY THE COPYRIGHT HOLDERS AND CONTRIBUTORS "AS IS" AND ANY EXPRESS OR IMPLIED WARRANTIES, INCLUDING, BUT NOT LIMITED TO, THE IMPLIED WARRANTIES OF MERCHANTABILITY AND FITNESS FOR A PARTICULAR PURPOSE ARE DISCLAIMED. IN NO EVENT SHALL THE FOUNDATION OR CONTRIBUTORS BE LIABLE FOR ANY DIRECT, INDIRECT, INCIDENTAL, SPECIAL, EXEMPLARY, OR CONSEQUENTIAL DAMAGES (INCLUDING, BUT NOT LIMITED TO, PROCUREMENT OF SUBSTITUTE GOODS OR SERVICES; LOSS OF USE, DATA, OR PROFITS; OR BUSINESS INTERRUPTION) HOWEVER CAUSED AND ON ANY THEORY OF LIABILITY, WHETHER IN CONTRACT, STRICT LIABILITY, OR TORT (INCLUDING NEGLIGENCE OR OTHERWISE) ARISING IN ANY WAY OUT OF THE USE OF THIS SOFTWARE, EVEN IF ADVISED OF THE POSSIBILITY OF SUCH DAMAGE.

### About Vorbis library

Copyright (c) 2001, Xiphophorus

Redistribution and use in source and binary forms, with or without modification, are permitted provided that the following conditions are met:  
- Redistributions of source code must retain the above copyright notice, this list of conditions and the following disclaimer.  
- Redistributions in binary form must reproduce the above copyright notice, this list of conditions and the following disclaimer in the documentation and/or other materials provided with the distribution.  
- Neither the name of the Xiphophorus nor the names of its contributors may be used to endorse or promote products derived from this software without specific prior written permission.

THIS SOFTWARE IS PROVIDED BY THE COPYRIGHT HOLDERS AND CONTRIBUTORS "AS IS" AND ANY EXPRESS OR IMPLIED WARRANTIES, INCLUDING, BUT NOT LIMITED TO, THE IMPLIED WARRANTIES OF MERCHANTABILITY AND FITNESS FOR A PARTICULAR PURPOSE ARE DISCLAIMED. IN NO EVENT SHALL THE REGENTS OR CONTRIBUTORS BE LIABLE FOR ANY DIRECT, INDIRECT, INCIDENTAL, SPECIAL, EXEMPLARY, OR CONSEQUENTIAL DAMAGES (INCLUDING, BUT NOT LIMITED TO, PROCUREMENT OF SUBSTITUTE GOODS OR SERVICES; LOSS OF USE, DATA, OR PROFITS; OR BUSINESS INTERRUPTION) HOWEVER CAUSED AND ON ANY THEORY OF LIABILITY, WHETHER IN CONTRACT, STRICT LIABILITY, OR TORT (INCLUDING NEGLIGENCE OR OTHERWISE) ARISING IN ANY WAY OUT OF THE USE OF THIS SOFTWARE, EVEN IF ADVISED OF THE POSSIBILITY OF SUCH DAMAGE.

### Notice for Windows Media DRM

The Certified For Windows Vista logo, Windows Media and the Windows logo are trademarks or registered trademarks of Microsoft Corporation in the United States and/or other countries.  
Content providers are using the digital rights management technology for Windows Media contained in this device (WMDRM) to protect the integrity of their content (Secure Content) so that their intellectual property, including copyright, in such content is not misappropriated.  
This device uses WM-DRM software to play Secure Content (WM-DRM Software).  
If the security of the WM-DRM Software in this device has been compromised, owners of Secure Content (Secure Content Owners) may request that Microsoft revoke the WM-DRM Software's right to acquire new licenses to copy, display and/or play Secure Content. Revocation does not alter the WM-DRM Software's ability to play unprotected content. A list of revoked WM-DRM Software is sent to your device whenever you download a license for Secure Content from the Internet or from a PC. Microsoft may, in conjunction with such license, also download revocation list onto your device on behalf of Secure Content Owners.

