

disklavier **ENSPIRE™**

**ST
PRO**

Owner's manual
Mode d'emploi
Benutzerhandbuch
Manual de instrucciones
Manuale di istruzioni

EN
FR
DE
ES
IT

SPECIAL MESSAGE SECTION

PRODUCT SAFETY MARKINGS: Yamaha electronic products may have either labels similar to the graphics shown below or molded/stamped facsimiles of these graphics on the enclosure. The explanation of these graphics appears on this page. Please observe all cautions indicated on this page and those indicated on the safety instruction section.

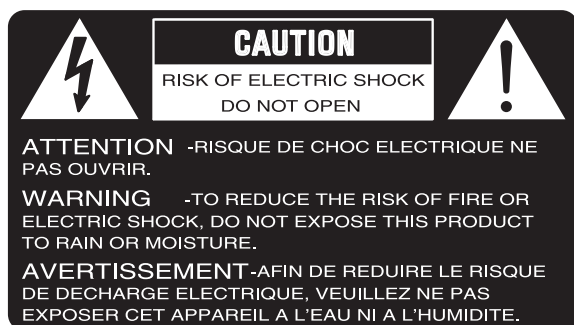

SEE BOTTOM OF ENCLOSURE OR LOWER FRONT PANEL FOR GRAPHIC SYMBOL MARKINGS



The exclamation point within the equilateral triangle is intended to alert the user to the presence of important operating and maintenance (servicing) instructions in the literature accompanying the product.

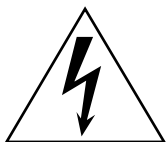

The lightning flash with arrowhead symbol within the equilateral triangle is intended to alert the user to the presence of uninsulated “dangerous voltage” within the product’s enclosure that may be of sufficient magnitude to constitute a risk of electrical shock.

IMPORTANT NOTICE: All Yamaha electronic products are tested and approved by an independent safety testing laboratory in order that you may be sure that when it is properly installed and used in its normal and customary manner, all foreseeable risks have been eliminated. DO NOT modify this unit or commission others to do so unless specifically authorized by Yamaha. Product performance and/or safety standards may be diminished. Claims filed under the expressed warranty may be denied if the unit is/has been modified. Implied warranties may also be affected.

SPECIFICATIONS SUBJECT TO CHANGE: The information contained in this manual is believed to be correct at the time of printing. However, Yamaha reserves the right to change or modify any of the specifications without notice or obligation to update existing units.

ENVIRONMENTAL ISSUES: Yamaha strives to produce products that are both user safe and environmentally friendly. We sincerely believe that our products and the production methods used to produce them, meet these goals. In keeping with both the letter and the spirit of the law, we want you to be aware of the following:

Battery Notice: This product MAY contain a small non-rechargeable battery which (if applicable) is soldered in place. The average life span of this type of battery is approximately five years. When replacement becomes necessary, contact a qualified service representative to perform the replacement.

Warning: Do not attempt to recharge, disassemble, or incinerate this type of battery. Keep all batteries away from children. Dispose of used batteries promptly and as regulated by applicable laws. Note: In some areas, the servicer is required by law to return the defective parts. However, you do have the option of having the servicer dispose of these parts for you.

Disposal Notice: Should this product become damaged beyond repair, or for some reason its useful life is considered to be at an end, please observe all local, state, and federal regulations that relate to the disposal of products that contain lead, batteries, plastics, etc.

NOTICE: Service charges incurred due to lack of knowledge relating to how a function or effect works (when the unit is operating as designed) are not covered by the manufacturer’s warranty, and are therefore the owners responsibility. Please study this manual carefully and consult your dealer before requesting service.

NAME PLATE LOCATION: The graphic below indicates the location of the name plate. The model number, serial number, power requirements, etc., are located on this plate. You should record the model number, serial number, and the date of purchase in the spaces provided below and retain this manual as a permanent record of your purchase.

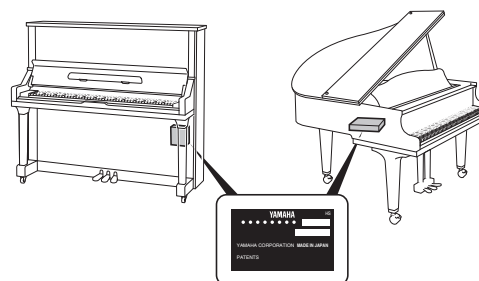

Model _____

Serial No. _____

Purchase Date _____

SECTION DE MESSAGE SPÉCIAL

INSCRIPTIONS DE SÉCURITÉ DU PRODUIT: Les produits électroniques Yamaha peuvent comporter des étiquettes semblables aux représentations graphiques indiquées ci-dessous ou fac-similés moulés/estampés de ces représentations graphiques sur l'encoffrement. L'explication de ces représentations graphiques apparaît à cette page. Veuillez respecter toutes les précautions indiquées à cette page et celles indiquées dans la section des directives de sécurité.

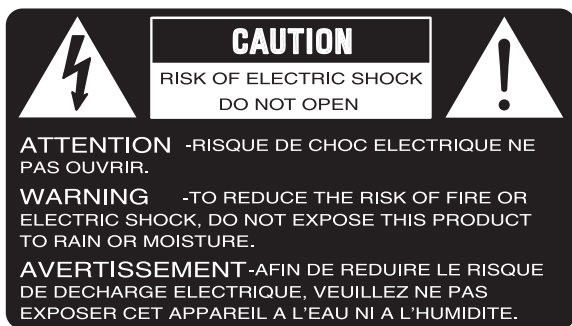

VOIR SOUS L'ENCOFFREMENT OU EN BAS DU PANNEAU FRONTAL EN CE QUI CONCERNE LES INSCRIPTIONS DE SYMBOLE GRAPHIQUES



Le point d'exclamation placé dans un triangle équilatéral est destiné à alerter l'utilisateur de la présence de directives importantes sur l'utilisation et l'entretien (dépannage) dans la documentation qui accompagne le produit.

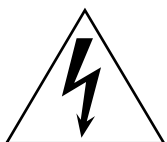

L'éclair de foudre avec le symbole en pointe de flèche dans un triangle équilatéral est destiné à alerter l'utilisateur de la présence d'une "tension dangereuse" non isolée circulant dans l'encoffrement du produit et qui peut avoir une puissance suffisante pour constituer un risque d'électrocution.

NOTIFICATION IMPORTANTE: Tous les produits électroniques Yamaha sont vérifiés et approuvés par un laboratoire de contrôle de sécurité indépendant pour que vous puissiez être sûr que quand il est correctement installé et utilisé de façon normale et habituelle, tous les risques prévisibles ont été éliminés. NE modifiez PAS cet appareil ni déléguez d'autres personnes à le faire à moins d'être autorisé spécifiquement par Yamaha à le faire. Les performances de ce produit et/ou les normes de sécurité peuvent être diminuées. Les réclamations soumises sous les termes de la garantie exprimée peuvent être refusées si l'appareil est ou a été modifié. Des garanties implicites peuvent également être affectées.

CARACTÉRISTIQUES SUJETTES À MODIFICATION: On pense que les informations contenues dans ce manuel sont correctes au moment de l'impression. Cependant, Yamaha se réserve le droit de changer ou de modifier toute caractéristique sans avis préalable ni obligation de mettre à jour les appareils existants.

PUBLICATION SUR L'ENVIRONNEMENT: Yamaha s'efforce de produire des appareils qui réunissent à la fois la sécurité à utilisateur et constituent un environnement convivial. Nous croyons sincèrement que nos produits et les méthodes de production les produisant, atteignent ces buts. En accord avec la lettre et l'esprit de la loi, nous voulons que vous vous rendiez compte de ce qui suit :

Notification relative à la batterie: Ce produit PEUT contenir une petite batterie non-rechargeable qui (quand ceci est applicable) est soudée en place. La durée moyenne de ce type de batterie est approximativement de cinq ans. Quand le remplacement devient nécessaire, prenez contact avec un technicien qualifié pour exécuter le remplacement.

Avertissement: N'essayez pas de recharger, démonter ou incinérer ce type de batterie. Maintenez toutes les batteries hors de la portée des enfants. Mettez les batteries usées au rebut et promptement conformément aux obligations imposées par les lois applicables. Remarque: Dans certains secteurs, il est exigé par la loi que le préposé à l'entretien renvoie les pièces défectueuses. Cependant, vous avez l'option que le préposé à l'entretien mette ces pièces au rebut pour vous.

Notification de mise au rebut: Si ce produit était endommagé au delà de la possibilité du dépannage, ou pour quelque raison si sa durée de vie utile est considérée comme arrivant à terme, veuillez respecter la réglementation d'état, locale et fédérale et qui est associée à la mise au rebut des produits qui contiennent du plomb, des batteries, des plastiques, etc.

NOTIFICATION: Les frais administratifs encourus en raison d'un manque de connaissance concernant la façon dont une fonction ou des effets réagissent (quand l'appareil est utilisé comme conçu) ne sont pas couverts par la garantie du constructeur, et incombent pour cette raison la responsabilité des propriétaires. Veuillez étudier attentivement ce manuel et consultez votre distributeur avant de demander un dépannage.

EMPLACEMENT DE LA PLAQUE SIGNALÉTIQUE: La représentation graphique ci-dessous indique l'emplacement de la plaque signalétique. Le numéro de modèle, le numéro de série, les conditions d'alimentation électrique, etc., sont mentionnées sur cette plaque. Vous devriez enregistrer le numéro de modèle, le numéro de série et la date de l'achat dans les espaces fournis ci-dessous et conserver ce manuel comme relevé permanent de votre achat.

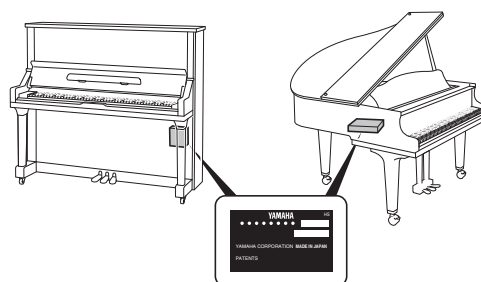

Modèle _____

Numéro de série _____

Date d'achat _____

IMPORTANT SAFETY INSTRUCTIONS

WARNING — When using any electrical or electronic product, basic precautions should always be followed. These precautions include, but are not limited to, the following:

1. Read these instructions.
2. Keep these instructions.
3. Heed all warnings.
4. Follow all instructions.
5. Do not use this apparatus near water.
6. Clean only with dry cloth.
7. Do not block any ventilation openings. Install in accordance with the manufacturer's instructions.
8. Do not install near any heat sources such as radiators, heat registers, stoves, or other apparatus (including amplifiers) that produce heat.
9. Do not defeat the safety purpose of the polarized or grounding-type plug. A polarized plug has two blades with one wider than the other. A grounding type plug has two blades and a third grounding prong. The wide blade or the third prong are provided for your safety. If the provided plug does not fit into your outlet, consult an electrician for replacement of the obsolete outlet.
10. Protect the power cord from being walked on or pinched particularly at plugs, convenience receptacles, and the point where they exit from the apparatus.
11. Only use attachments/accessories specified by the manufacturer.
12. Use only with the cart, stand, tripod, bracket, or table specified by the manufacturer, or sold with the apparatus. When a cart is used, use caution when moving the cart/apparatus combination to avoid injury from tip-over. 
13. Unplug this apparatus during lightning storms or when unused for long periods of time.
14. Refer all servicing to qualified service personnel. Servicing is required when the apparatus has been damaged in any way, such as power-supply cord or plug is damaged, liquid has been spilled or objects have fallen into the apparatus, the apparatus has been exposed to rain or moisture, does not operate normally, or has been dropped.
15. This product shall not be exposed to dripping or splashing and that no objects filled with liquids, such as vases, shall be placed on the apparatus.
16. Do not put burning items, such as candles, on the apparatus.
17. Do not place this product or any other objects on the power cord or place it in a position where anyone could walk on, trip over, or roll anything over power or connecting cords of any kind. The use of an extension cord is not recommended! If you must use an extension cord, the minimum wire size for a 25' cord (or less) is 18 AWG. NOTE: The smaller the AWG number, the larger the current handling capacity. For longer extension cords, consult a local electrician.
18. **WARNING** — To reduce the risk of fire or electric shock, do not expose this apparatus to rain or moisture.
19. Care should be taken that objects do not fall and liquids are not spilled into the enclosure through any openings that may exist.
20. This product, either alone or in combination with an amplifier and headphones or speaker/s, may be capable of producing sound levels that could cause permanent hearing loss. DO NOT operate for a long period of time at a high volume level or at a level that is uncomfortable. If you experience any hearing loss or ringing in the ears, you should consult an audiologist. IMPORTANT: The louder the sound, the shorter the time period before damage occurs.
21. Some Yamaha products may have benches and/or accessory mounting fixtures that are either supplied as a part of the product or as optional accessories. Some of these items are designed to be dealer assembled or installed. Please make sure that benches are stable and any optional fixtures (where applicable) are well secured BEFORE using. Benches supplied by Yamaha are designed for seating only. No other uses are recommended.
22. This product shall be connected to a MAINS socket outlet with a protective earthing connection.
23. This product has a power switch for shutting off all system. The switch is located on the Power Supply Unit nearby the entrance of the AC cord. Note that the switch on the Controller does not shutdown all system.
24. Make sure that the plug of the Power Supply Unit's power cable can easily be disconnected from the AC outlet as a measure of precaution.

Outlets for Speakers

- Connect speakers of 2A or less of totals. Do not connect other products except speakers.
- Consult Yamaha service technician when using the outlets outside the purchased area.

INSTRUCTIONS DE SÉCURITÉ IMPORTANTES

AVERTISSEMENT — Lors de l'utilisation de n'importe quel appareil électrique ou électronique, les précautions fondamentales devraient toujours être suivies. Ces précautions comprennent, mais ne sont pas limitées à, ce qui suit:

1. Lisez ces directives.
2. Conservez ces directives.
3. Observez tous les avertissements.
4. Suivez toutes les directives.
5. N'utilisez pas cet appareil près de l'eau.
6. Nettoyez seulement avec un tissu sec.
7. Ne bloquez aucune des ouvertures de ventilation. Installez conformément aux directives du constructeur.
8. N'installez près d'aucune source de chaleur telle que des radiateurs, des registres de chaleur, des appareils de chauffage ou d'autres appareils (amplificateurs y compris) qui produisent de la chaleur.
9. N'asservissez pas l'objectif de sécurité de la prise de type polarisée ou de mise à la terre. Une prise polarisée a deux lames avec une plus large que l'autre. Une prise de type à mise à la terre a deux lames et une troisième lame de mise à la terre. La lame large ou la troisième lame est prévue pour votre sécurité. Si la prise fournie ne s'ajuste pas dans votre prise secteur, consultez un électricien pour le remplacement de l'ancien modèle de prise.
10. Protégez le cordon d'alimentation de secteur afin que personne ne puisse marcher ni le pincer en particulier les prises, les prises de courant et la position où il quitte de l'appareil.
11. Utilisez seulement les équipements ou accessoires indiqués par le constructeur.
12. Utilisez seulement avec le chariot, le support, le trépied, la platine de fixation ou la table indiquée par le constructeur, ou vendue avec l'appareil. Quand un chariot est utilisé, faites attention en déplaçant la combinaison chariot/appareil pour éviter de se blesser en renversant l'appareil. 
13. Débranchez cet appareil pendant les orages et la foudre ou s'il est inutilisé pendant de longues périodes.
14. Confiez toutes les opérations d'entretien au personnel de service qualifié. L'entretien est exigé quand l'appareil a été endommagé de quelque façon que ce soit, comme par exemple l'endommagement du cordon ou de la prise d'alimentation secteur, quand du liquide a été renversé ou que des objets sont tombés dans l'appareil, l'appareil a été exposé à la pluie ou à l'humidité, ne fonctionne pas normalement ou est tombé par terre.
15. Ce produit ne doit pas être exposé à un suintement ou des éclaboussures et aucun objet rempli de liquide, tels que des vases, ne doit être mis sur l'appareil.
16. Ne mettez pas des articles brûlants, tels que des bougies, sur l'appareil.
17. Ne placez ce produit ni aucun autre objet sur le cordon d'alimentation secteur ou ne le placez pas dans une position où n'importe qui pourrait marcher dessus, trébucher dedans ou faire rouler n'importe quoi sur les cordons d'alimentation en aucune manière. L'utilisation d'un cordon prolongateur n'est pas recommandée ! Si vous devez utiliser un cordon prolongateur, la taille minimum du calibre de fil du cordon pour un cordon de 25 pouces (ou moins) est de 18 du calibre américain normalisé. REMARQUE: Plus le numéro du calibre américain normalisé est petit, plus la capacité de gestion de l'intensité est grande. Pour de plus longs cordons prolongateurs, consultez un électricien local.
18. **AVERTISSEMENT** — Pour réduire les risques d'incendie ou de décharge électrique, n'exposez pas cet appareil à la pluie ou à l'humidité.
19. Un soin tout particulier devrait être pris pour qu'aucun objet ne tombe et que des liquides ne soient renversés dans l'encoffrement par aucune des ouvertures qui peuvent exister.
20. Ce produit, individuel ou en combinaison avec un amplificateur et des écouteurs ou le ou les haut-parleurs, risque de produire des niveaux sonores qui pourraient causer une perte d'auditive permanente. NE PAS mettre en service pendant une longue période à un niveau de volume élevé ou à un niveau qui est inconfortable. Si vous éprouvez n'importe quelle sorte de perte auditive ou de sonnerie dans les oreilles, vous devriez consulter un audiologiste. IMPORTANT : Plus le son est fort, plus la période de temps avant que les dégâts se produisent est courte.
21. Certains produits Yamaha peuvent avoir des supports et/ou des accessoires d'installation complémentaires qui sont fournis comme partie du produit ou en tant qu'accessoires optionnels. Certains de ces articles sont conçus pour être montés ou installés par le distributeur. Veuillez vous assurer que les supports sont stables et que tous les accessoires optionnels (quand ceci est applicable) sont bien fixés AVANT l'utilisation. Les supports fournis par Yamaha sont conçus pour un positionnement seulement. Aucune autre utilisation n'est recommandée.
22. Ce produit doit être connecté à une prise de sortie secteur munie d'une connexion protectrice par la mise à la terre.
23. Ce produit est muni d'un interrupteur d'alimentation permettant de couper l'alimentation de tout le système. L'interrupteur d'alimentation est installé sur le bloc d'alimentation tout près l'entrée du cordon d'alimentation secteur. Notez que l'interrupteur d'alimentation sur le contrôleur n'arrête tout le système.
24. Assurez-vous que la prise du cordon d'alimentation électrique du bloc d'alimentation peut facilement être débranchée de la prise de sortie secteur comme mesure de précaution.

Prises de sortie pour des haut-parleurs

- Connectez des haut-parleurs de 2A ou moins au total. Ne connectez aucun autre produit excepté des haut-parleurs.
- Consultez le technicien de service Yamaha quand des prises sont utilisées en dehors du secteur d'achat.

COMPLIANCE INFORMATION STATEMENT

Responsible Party : Yamaha Corporation of America
Address : 6600 Orangethorpe Avenue, Buena Park, CA 90620 USA
Telephone : 1-714-522-9011
Fax : 1-714-522-9301
Type of Equipment : Player Piano
Model Name : DGB1KENST, DGN1ENST, DGB1KENCL, DGN1ENCL, DGC1ENST, DGC2ENST, DC1XENST, DC2XENST, DC3XENST, DC3XENPRO, DC5XENPRO, DC6XENPRO, DC7XENPRO, DS4ENPRO, DS6ENPRO, DS3XENPRO, DS5XENPRO, DS6XENPRO, DS7XENPRO, DCF4ENPRO, DCF6ENPRO, DCFXENPRO, DU1ENST, DYUS1ENST, DYUS3ENST, DYUS5ENST
Type of Equipment : Piano Player Unit
Model Name : VEN-1, VEN-2, VEN-3, VEN-4, VEN-1H, VEN-2H, VEN-3H, VEN-4H, VEN-10, VEN-20

This device complies with Part 15 of the FCC Rules.

Operation is subject to the following two conditions:

- 1) this device may not cause harmful interference, and
 - 2) this device must accept any interference received including interference that may cause undesired operation.
- See user manual instructions if interference to radio reception is suspected.

The above statements apply ONLY to those products distributed by Yamaha Corporation of America or its subsidiaries.

FCC INFORMATION (U.S.A.)

1. **IMPORTANT NOTICE: DO NOT MODIFY THIS UNIT!**
This product, when installed as indicated in the instructions contained in this manual, meets FCC requirements. Modifications not expressly approved by Yamaha may void your authority, granted by the FCC, to use the product.
2. **IMPORTANT:** When connecting this product to accessories and/or another product use only high quality shielded cables. Cable/s supplied with this product **MUST** be used. Follow all installation instructions. Failure to follow instructions could void your FCC authorization to use this product in the USA.
3. **NOTE:** This product has been tested and found to comply with the requirements listed in FCC Regulations, Part 15 for Class "B" digital devices. Compliance with these requirements provides a reasonable level of assurance that your use of this product in a residential environment will not result in harmful interference with other electronic devices. This equipment generates/uses radio frequencies and, if not installed and used according to the instructions found in the users manual, may cause interference harmful to the operation of other electronic devices. Compliance with FCC regulations does not guarantee that interference will not occur in all installations. If this product is found to be the source of interference, which can be determined by turning the unit "OFF" and "ON", please try to eliminate the problem by using one of the following measures:
Relocate either this product or the device that is being affected by the interference.
Utilize power outlets that are on different branch (circuit breaker or fuse) circuits or install AC line filter/s.
In the case of radio or TV interference, relocate/reorient the antenna. If the antenna lead-in is 300 ohm ribbon lead, change the lead-in to coaxial type cable.
If these corrective measures do not produce satisfactory results, please contact the local retailer authorized to distribute this type of product. If you can not locate the appropriate retailer, please contact Yamaha Corporation of America, Electronic Service Division, 6600 Orangethorpe Ave, Buena Park, CA 90620

The above statements apply ONLY to those products distributed by Yamaha Corporation of America or its subsidiaries.

Laite on liitettävä suojamaadoituskoskettimilla varustettuun pistorasiaan.

Apparatet må tilkoples jordat stikkontakt.

Apparaten skall anslutas till jordat uttag.

Information for Users on Collection and Disposal of Old Equipment



This symbol on the products, packaging, and/or accompanying documents means that used electrical and electronic products should not be mixed with general household waste. For proper treatment, recovery and recycling of old products, please take them to applicable collection points, in accordance with your national legislation and the Directives 2002/96/EC.

By disposing of these products correctly, you will help to save valuable resources and prevent any potential negative effects on human health and the environment which could otherwise arise from inappropriate waste handling.

For more information about collection and recycling of old products, please contact your local municipality, your waste disposal service or the point of sale where you purchased the items.

[For business users in the European Union]

If you wish to discard electrical and electronic equipment, please contact your dealer or supplier for further information.

[Information on Disposal in other Countries outside the European Union]

This symbol is only valid in the European Union. If you wish to discard these items, please contact your local authorities or dealer and ask for the correct method of disposal.

Information concernant la Collecte et le Traitement des déchets d'équipements électriques et électroniques



Le symbole sur les produits, l'emballage et/ou les documents joints signifie que les produits électriques ou électroniques usagés ne doivent pas être mélangés avec les déchets domestiques habituels.

Pour un traitement, une récupération et un recyclage appropriés des déchets d'équipements électriques et électroniques, veuillez les déposer aux points de collecte prévus à cet effet, conformément à la réglementation nationale et aux Directives 2002/96/EC.

En vous débarrassant correctement des déchets d'équipements électriques et électroniques, vous contribuerez à la sauvegarde de précieuses ressources et à la prévention de potentiels effets négatifs sur la santé humaine qui pourraient advenir lors d'un traitement inapproprié des déchets.

Pour plus d'informations à propos de la collecte et du recyclage des déchets d'équipements électriques et électroniques, veuillez contacter votre municipalité, votre service de traitement des déchets ou le point de vente où vous avez acheté les produits.

[Pour les professionnels dans l'Union Européenne]

Si vous souhaitez vous débarrasser des déchets d'équipements électriques et électroniques veuillez contacter votre vendeur ou fournisseur pour plus d'informations.

[Information sur le traitement dans d'autres pays en dehors de l'Union Européenne]

Ce symbole est seulement valable dans l'Union Européenne. Si vous souhaitez vous débarrasser de déchets d'équipements électriques et électroniques, veuillez contacter les autorités locales ou votre fournisseur et demander la méthode de traitement appropriée.

Verbraucherinformation zur Sammlung und Entsorgung alter Elektrogeräte



Befindet sich dieses Symbol auf den Produkten, der Verpackung und/oder beiliegenden Unterlagen, so sollten benutzte elektrische Geräte nicht mit dem normalen Haushaltsabfall entsorgt werden.

In Übereinstimmung mit Ihren nationalen Bestimmungen und den Richtlinien 2002/96/EC, bringen Sie alte Geräte bitte zur fachgerechten Entsorgung, Wiederaufbereitung und Wiederverwendung zu den entsprechenden Sammelstellen.

Durch die fachgerechte Entsorgung der Elektrogeräte helfen Sie, wertvolle Ressourcen zu schützen und verhindern mögliche negative Auswirkungen auf die menschliche Gesundheit und die Umwelt, die andernfalls durch unsachgerechte Müllentsorgung auftreten könnten.

Für weitere Informationen zum Sammeln und Wiederaufbereiten alter Elektrogeräte, kontaktieren Sie bitte Ihre örtliche Stadt oder Gemeindeverwaltung, Ihren Abfallentsorgungsdienst oder die Verkaufsstelle der Artikel.

[Information für geschäftliche Anwender in der Europäischen Union]

Wenn Sie Elektrogeräte ausrangieren möchten, kontaktieren Sie bitte Ihren Händler oder Zulieferer für weitere Informationen.

[Entsorgungsinformation für Länder außerhalb der Europäischen Union]

Dieses Symbol gilt nur innerhalb der Europäischen Union. Wenn Sie solche Artikel ausrangieren möchten, kontaktieren Sie bitte Ihre örtlichen Behörden oder Ihren Händler und fragen Sie nach der sachgerechten Entsorgungsmethode.

Información para Usuarios sobre Recolección y Disposición de Equipamiento Viejo



Este símbolo en los productos, embalaje, y/o documentación que se acompañe significa que los productos electrónicos y eléctricos usados no deben ser mezclados con desechos hogareños corrientes. Para el tratamiento, recuperación y reciclado apropiado de los productos viejos, por favor llévelos a puntos de recolección aplicables, de acuerdo a su legislación nacional y las directivas 2002/96/EC.

Al disponer de estos productos correctamente, ayudará a ahorrar recursos valiosos y a prevenir cualquier potencial efecto negativo sobre la salud humana y el medio ambiente, el cual podría surgir de un inapropiado manejo de los desechos.

Para mayor información sobre recolección y reciclado de productos viejos, por favor contacte a su municipio local, su servicio de gestión de residuos o el punto de venta en el cual usted adquirió los artículos.

[Para usuarios de negocios en la Unión Europea]

Si usted desea deshacerse de equipamiento eléctrico y electrónico, por favor contacte a su vendedor o proveedor para mayor información.

[Información sobre la Disposición en otros países fuera de la Unión Europea]

Este símbolo sólo es válidos en la Unión Europea. Si desea deshacerse de estos artículos, por favor contacte a sus autoridades locales y pregunte por el método correcto de disposición.

Informazioni per gli utenti sulla raccolta e lo smaltimento di vecchia attrezzatura



Questo simbolo sui prodotti, sull'imballaggio, e/o sui documenti che li accompagnano significa che i prodotti elettriche e elettroniche non dovrebbero essere mischiati con i rifiuti domestici generici.

Per il trattamento, recupero e riciclaggio appropriati di vecchi prodotti, li porti, prego, ai punti di raccolta appropriati, in accordo con la Sua legislazione nazionale e le direttive 2002/96/CE.

Smaltendo correttamente questi prodotti, Lei aiuterà a salvare risorse preziose e a prevenire alcuni potenziali effetti negativi sulla salute umana e l'ambiente, che altrimenti potrebbero sorgere dal trattamento improprio dei rifiuti.

Per ulteriori informazioni sulla raccolta e il riciclaggio di vecchi prodotti, prego contatti la Sua amministrazione comunale locale, il Suo servizio di smaltimento dei rifiuti o il punto vendita dove Lei ha acquistato gli articoli.

[Per utenti imprenditori dell'Unione europea]

Se Lei desidera disfarsi di attrezzatura elettrica ed elettronica, prego contatti il Suo rivenditore o fornitore per ulteriori informazioni.

[Informazioni sullo smaltimento negli altri Paesi al di fuori dell'Unione europea]

Questo simbolo è validi solamente nell'Unione europea. Se Lei desidera disfarsi di questi articoli, prego contatti le Sue autorità locali o il rivenditore e richieda la corretta modalità di smaltimento.

(For European Countries) Importer: Yamaha Music Europe GmbH Siemensstrasse 22-34, 25462 Rellingen, Germany

disklavier **ENSPIRE™**

ST PRO

English

Owner's Manual

Table of Contents

About the Manuals	2	Chapter 4 Troubleshooting	29
Included Accessories	2	Error Indications	31
Chapter 1 Introduction	6	Chapter 5 Glossary	32
Main Features	6	Chapter 6 Specifications	34
Names of Parts and Their Functions.....	8	General Specifications	34
Compatible Media and File Format.....	13	Appendix XG Voice List.....	A-3
Chapter 2 Getting Started.....	14	XG Drum Kit List.....	A-6
Connecting the AC Power Cable	14	MIDI Data Format	A-8
Connect powered speakers (Sold separately for Upright piano).....	15	MIDI IMPLEMENTATION CHART	
Turning the Power On/Off	16 at the end of the book	
How to use the SILENT Piano™ Function (For Pianos Equipped with the SILENT Piano™ Function)	18		
Connecting the Product and Smart Device to a Network.....	19		
Choosing the Network Connection Method.....	20		
Wireless Network Connection by WPS	22		
Wired Network Connection	24		
Direct Wireless Connection.....	25		
Using the ENSPIRE Controller App	26		
IDC Registration.....	26		
Chapter 3 Other Settings.....	27		
Updating this product	27		
Initializing Network Settings	28		

Welcome to the Yamaha Disklavier™!

Thank you for purchasing the Yamaha Disklavier!
Before using your this product, please read this manual thoroughly and retain it for future reference.

■ About this product

Disklavier is a piano with various advanced, convenient features, including automatic performance, ensemble and SILENT Piano™ functions.

By installing the dedicated app, you can easily set and operate functions from the screen of your smart device.

About the Manuals

The following instruction manuals are available for this product.

■ Booklet manual



Disklavier ENSPIRE ST/PRO Owner's Manual (this book)

Describes the functions, connection methods, and operation instructions of this product.

For information on handling as an acoustic piano, refer to the separate manual for the piano.



Disklavier ENSPIRE Built-in song list

This is a list of built-in songs that can be automatically played by this product.

You can also download this list from the Yamaha website.

■ Online Manuals (PDF)



Disklavier ENSPIRE Controller Operation Manual

This is the operation manual for the ENSPIRE Controller app, which is a special app that lets you actually operate the various functions of this product.

You can call up this operation manual from the Information screen of the ENSPIRE Controller app. You can also download the manual from the Yamaha website.

To obtain these materials, access the Yamaha Downloads website, then enter the model name for searching the desired files.

Yamaha Downloads

<https://download.yamaha.com/>

Included Accessories

Please make sure that you have the following accessories:

- Monitor speaker^{*1 *2} × 2
- Monitor speaker installation kit^{*1 *2} × 2
- Stereo headphones × 1
- Owner's manual × 1
- Built-in song list × 1
- Music book "50 greats for the Piano" × 1
- USB wireless LAN adaptor (UD-WL01) × 1

*1 Only for grand pianos.

*2 Not supplied on some models.

PRECAUTIONS

PLEASE READ CAREFULLY BEFORE PROCEEDING

Please keep this manual in a safe and handy place for future reference.

WARNING

Always follow the basic precautions listed below to avoid the possibility of serious injury or even death from electrical shock, short-circuiting, damages, fire or other hazards. These precautions include, but are not limited to, the following:

■ Power supply

- Do not place the power cord near heat sources such as heaters or radiators. Also, do not excessively bend or otherwise damage the cord, or place heavy objects on it.
- Do not touch the product or the power plug during an electrical storm.
- Use only the correct voltage specified for the product. The required voltage is printed on the name plate of the product.
- Use only the supplied power cord. Do not use the power cord for other devices.
- Check the power plug periodically and remove any dirt or dust which may have accumulated on it.
- Insert the power plug firmly all the way into the AC outlet. Using the product when it is not plugged in sufficiently can cause dust to accumulate on the plug, possibly resulting in fire or skin burns.
- When setting up the product, make sure that the AC outlet you are using is easily accessible. If some trouble or malfunction occurs, immediately turn off the power switch and disconnect the plug from the outlet. Even when the power switch is turned off, as long as the power cord is not unplugged from the wall AC outlet, the product will not be disconnected from the power source.
- Do not connect the product to an electrical outlet using a multi-plug outlet extender. Doing so can result in lower sound quality, or possibly cause overheating in the outlet.
- When disconnecting the power plug, always hold the plug itself and not the cord. Pulling by the cord can damage it and cause electric shocks or a fire.
- If not using the product for long periods of time, be sure to pull the power plug from the AC outlet.
- Be sure to connect to an appropriate outlet with a protective grounding connection. Improper grounding can result in electrical shock.

■ Do not disassemble

- This product contains no user-serviceable parts. Do not attempt to disassemble the internal parts or modify them in any way.

■ Water warning

- Do not expose the product to rain, use it near water or in damp or wet conditions, or place on it any containers (such as vases, bottles or glasses) containing liquids which might spill into any openings or places where water may drop. A liquid such as water getting into the product may cause a fire, electric shocks, or malfunctions.
- Never insert or remove a power plug with wet hands.

■ Fire warning

- Do not place any burning items or open flames near the product, since they may cause a fire.

■ Connections

- Be sure to read the manual of the device to be connected, and follow the instructions. Failure to observe this may cause a fire, overheating, explosion, or malfunction.

■ If you notice any abnormality

- If any of the following problems occur, immediately turn off the power switch and disconnect the power plug from the outlet. Finally have the device inspected by Yamaha service personnel.
 - The power cord or plug becomes frayed or damaged.
 - Unusual smells or smoke are emitted.
 - Some object, or water has been dropped into the product.
 - There is a sudden loss of sound during use of the product.
 - Cracks or other visible damage appear on the product.

CAUTION

Always follow the basic precautions listed below to avoid the possibility of physical injury to you or others, or damage to the product or other property. These precautions include, but are not limited to, the following:

■ Location

- Do not block any ventilation openings, since this may prevent adequate ventilation of the internal components, and possibly result in the instrument overheating.
- Do not place the product in an unstable position or a location with excessive vibration, where it might accidentally fall over and cause injury.
- Do not go near the product during an earthquake. Strong shaking during an earthquake could cause the product to move or tip over, resulting in damage to the product or its parts, and possibly causing injury.
- Before moving the piano, consult with a specialist experienced in moving pianos. Pianos are extremely heavy. When moving a piano, there is a risk of causing back injury and scratching the floor.
- Before moving the product, remove all connected cables, to prevent damage to the cables or injury to anyone who might trip over them.

■ Connections

- Before connecting the product to other devices, turn off the power for all devices. Before turning the power on or off for all devices, set all volume levels to minimum.
- Be sure to set the volumes of all devices at their minimum levels and gradually raise the volume controls while playing the product to set the desired listening level.

■ Handling

- Do not insert foreign materials such as metal or paper into any openings or gaps of the product. Failure to observe this may cause a fire, electric shocks, or malfunctions.
- Do not rest your weight on, or place heavy objects on the product, and do not use excessive force on the buttons, switches or connectors.
- Do not use the product or headphones for a long period of time at a high or uncomfortable volume level, since this can cause permanent hearing loss. If you experience any hearing loss or ringing in the ears, consult a physician.
- Remove the power plug from the AC outlet before cleaning the unit. Failure to observe this may cause electric shocks.

Yamaha cannot be held responsible for damage caused by improper use or modifications to the product, or data that is lost or destroyed.

Always turn the power off when the product is not in use.

Even when the [⏻] (Standby/On) button is in standby status (indicator is dimly lit), electricity is still flowing to the product at the minimum level.

When you are not using the product for a long time, make sure you unplug the power cord from the wall AC outlet.

(DMI-11)

NOTICE

To avoid the possibility of malfunction/ damage to the product, damage to data, or damage to other property, follow the notices below.

■ Handling

- Do not connect this product to a public Wi-Fi and/ or Internet service directly. Only connect this product to the Internet through a router with strong password protections. Consult your router manufacturer for information on optimum security practices.
- Do not use this product in the vicinity of a TV, radio, stereo equipment, mobile phone, or other electric devices. Otherwise, this product or the other device may generate noise.
- When you use the product along with an app on your smart device, such as a smartphone or tablet, we recommend that you enable “Airplane Mode” on the device to avoid noise caused by communication. When turning on airplane mode, Wi-Fi settings may be turned off. Make sure that the setting is turned on before use.
- Do not expose the product to excessive dust or vibrations, or extreme cold or heat (such as in direct sunlight, near a heater, or in a car during the day) to prevent the possibility of disfiguration, damage to the internal components or unstable operation.
- Do not place vinyl, plastic or rubber objects on the product, since this might discolor the product.

■ Trademarks & Copyrights

- The contents of this manual and the copyrights thereof are under exclusive ownership by Yamaha Corporation.
- Yamaha, Disklavier™, disklavier ENSPIRE™, SILENT Piano™, DisklavierRadio, PianoSoft, and PianoSoftPlus are trademarks of Yamaha Corporation.



- SmartKey and CueTIME are trademarks of Yamaha Corporation or Yamaha Corporation of America.
- Disklavier ENSPIRE software, Copyright © 2016 Yamaha Corporation.
- This contains programs licensed under the GNU General Public License, GNU Lesser General Public License, the BSD Copyright, the Artistic License, and others.
- This product includes software developed by the OpenSSL Project for use in the OpenSSL Toolkit. (<http://www.openssl.org/>)
- App Store is a trademark of Apple Inc., registered in the U.S. and other countries.
- Android and Google Play are trademarks of Google LLC.
- The company names and product names in this manual are the trademarks or registered trademarks of their respective companies.
- The illustrations and LCD screens as shown in this manual are for instructional purposes only, and may appear somewhat different from those on your instrument.

Notes on Source Code Distribution

For three years after the factory shipment, you may request from Yamaha the source code for any portions of the product which are licensed under the GNU General Public License by writing to the following address:

10-1 Nakazawa-cho, Naka-ku, Hamamatsu,
Shizuoka, 430-8650, JAPAN
Piano Development Department, Yamaha
Corporation

The source code will be provided at no charge; however, we may require you to reimburse Yamaha for the cost of delivering the source code to you.

- Note that we shall bear no responsibility whatsoever for any damage arising from changes (additions/deletions) made to the software for this product by a third party other than Yamaha (or party authorized by Yamaha).
- Note that re-use of source code released to the public domain by Yamaha is unguaranteed, and Yamaha shall not bear any responsibility whatsoever for the source code.

The model number, serial number, power requirements, etc., may be found on or near the name plate, which is at the bottom of the unit. You should note this serial number in the space provided below and retain this manual as a permanent record of your purchase to aid identification in the event of theft.

Model No.

Serial No.

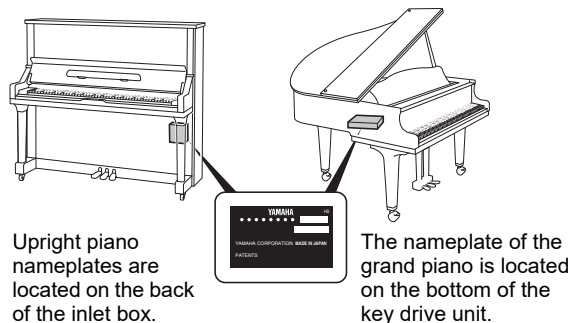

Introduction

Main Features

This product provides a variety of sophisticated features and advanced functions that greatly expand the capabilities of your piano—and enhance your musical enjoyment.

Automatic performance from a real acoustic piano

- Non-contact optical sensors detect the movement of the keys with a high level of fidelity, recording and reproducing the most delicate nuances of any piano performance. This reproduces not only the movement of the keys, but also of the pedals, and even half-pedaling, delivering a performance almost indistinguishable from that of a real pianist. What's more, the PRO model features hammer sensor feedback, allowing reproduction of the nuances of techniques such as rapid note repetition and softly played notes. You can even directly adjust the volume of the beautiful acoustic piano sound.

Simple operation with your smart device

- By connecting your smartphone, tablet or other smart device to the same network as this product and installing the special ENSPIRE Controller app, you can use a variety of functions, such as the auto play function that records and reproduces piano performances and the ensemble function that plays various instrumental parts using the wide range of voices produced by the built-in tone generator.
- Choose your favorites from 500 built-in songs or purchased songs, and enjoy your favorite songs in your own original playlist.



See page 19 for more information on the ENSPIRE Controller app.

Note:

- Yamaha product firmware and supplied apps may occasionally be updated to improve functionality and operability. Certain functions may not be available with older versions, so we recommend that you update to the latest version. Refer to page 27 for how to update the version of this product.
- For the smart device, refer to the glossary (page 33).

Huge Variety of Professional-quality Songs

- A total of 500 piano pieces are stored internally, ranging in genre from famous classical pieces to popular music and jazz, there for you to enjoy as the mood takes you. Songs including professional vocal performances by artists in collaboration with Yamaha let you experience the atmosphere of a live performance, and Yamaha also provides a special 24-hour DisklavierRadio streaming service.

* An optional powered speaker is required to play back parts other than the piano sound. (Sold separately for upright piano.)

- Music of various genres is available for purchase via download from the yamahamusicsoft.com on the Yamaha website, letting you buy the latest songs at any time from the comfort of your home. Insert a USB flash drive to your Internet-connected Disklavier in order to download and immediately start playing purchased data via the ENSPIRE Controller app.

Convenient Functions

- Practice effectively by recording your own piano performances for playback and objective checking later, or practice playing the right hand part to a piece with just the left hand recorded. You can record recitals or daily practice sessions, allowing you to save and replay treasured moments.
- If you have a piano with the SILENT Piano™ function, you can use headphones for night practice, etc., and play without producing sound from the acoustic piano. Enjoy performing with the faithfully sampled sound of the Yamaha CFX concert grand piano.
- SmartKey feature that shows you the next key to play with by moving the keys slightly—an ideal function for beginners. Playing the keys in the order shown leads you through the song, allowing even beginning players to enjoy practicing. For SmartKey Songs, please refer to the included built-in song list.

Names of Parts and Their Functions

This product is equipped with the following units.

- Switch Box (following)..... Turn this product on/off to control functions.
- Control Center Unit (page 10)..... It is equipped with terminals for connecting external devices.
- Inlet Box (page 11)..... There are terminals for turning on / off the main power supply and connecting to external devices.
- Power supply unit (page 16) Equipped with a switch to turn on / off main power.

■ Switch Box (Front and Bottom panel)

Front panel

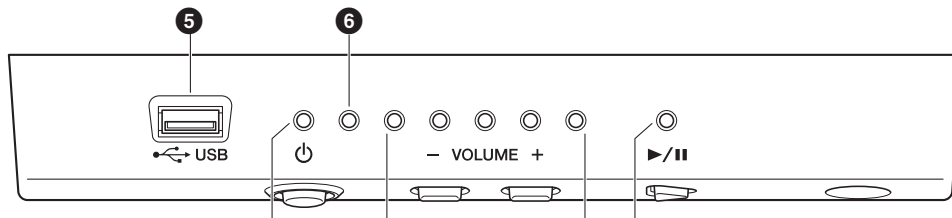

Bottom panel

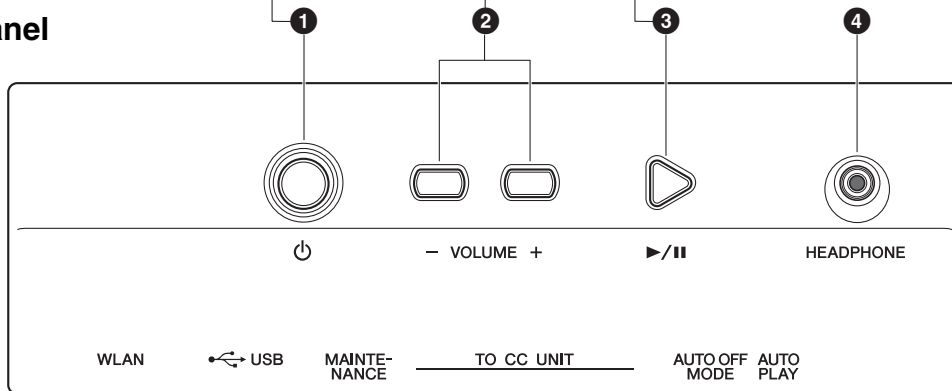

❶ [⏻] (Standby/On) button/indicator

Turns this product on or off. When this button is operated, the [⏻] lamp on the front of the switch box indicates the power status as follows.

Condition	Status
Off	This product cannot be turned on because the power plug is unplugged.
Lit	This product is turned on.
Dim lit	This product is turned off (standby).
Flashing	This product is shutting down.
Slow flashing	This product is starting up.

❷ [- VOLUME +] buttons/indicators

These display the volume level (over 10 steps). Each indicator shows the volume in 2 steps with varying brightness.

❸ [▶/||] (Play/Pause) button/indicator

For starting and pauses playback.

- Playback starts from the last loaded song before turning the power off.
- If the last song cannot be loaded, playback starts from the first song of the internal demo songs.

The indicator lights up when playing back a song. If song playback is stopped/paused, the indicator will go dark.

4 [HEADPHONE] jack

Connect a set of headphones to this jack and hear the digital piano sounds from the headphones.

⚠ Caution:

- To prevent damage to your hearing, refrain from raising the volume to excessive levels, and do not use the headphones for extended periods of time.
- Do not pull the headphone cord or apply excessive force on the plug. This can damage the headphone and lead to sound output malfunction.

5 [USB] terminal

Used to connect the USB flash drive.

Note:

This product cannot detect the USB flash drive if two or more memory devices are connected at the same time.

6 Error indicator

Flashes when some error has occurred. See “Error Indications” on page 31.

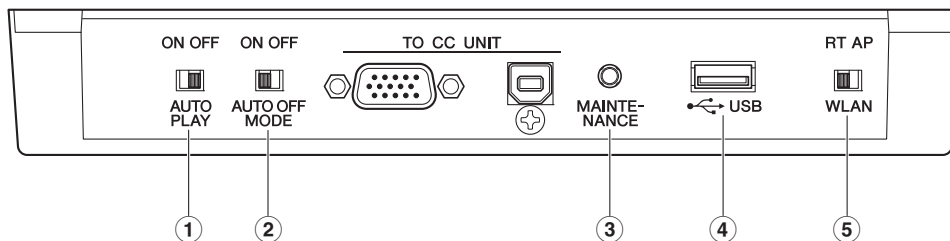
■ Switch Box (Rear Panel)**1 [AUTO PLAY] switch**

For activating or deactivating the auto play function. If you leave the switch set to “ON,” playback automatically starts when the power is turned on. (Default setting: OFF)

2 [AUTO OFF MODE] switch

When this is turned on, this product will turn off automatically if the following conditions continue for a certain period of time. (Default setting: ON)

- No operation has been performed on the switch box.
- No operation has been performed on the ENSPIRE Controller app.
- The keyboard has not been played.
- This product has not received the MIDI data.

Note:

You can change the automatic turn off time with the ENSPIRE Controller app.

3 [MAINTENANCE] button

For service personnel only. Do not touch this button.

4 [USB] terminal

Used to connect the USB wireless LAN adaptor (UD-WL01).

Note:

This product cannot detect the USB flash drive if two or more memory devices are connected at the same time.

5 [WLAN] switch

For setting the method for wireless LAN connection when connecting the USB wireless LAN adaptor to the [USB] terminal. See “Connecting the Product and Smart Device to a Network” on page 19. (Default setting: RT)

Functions that can be operated by Switch Box

The functions that can be operated with the Switch Box are only power on/off, song playback/pause, and volume control of acoustic piano/internal electronic sound source (page 16). The other functions are controlled only from the application of your smartphone or tablet.

Introduction

■ Control Center Unit (for Grand Pianos)

Rear panel

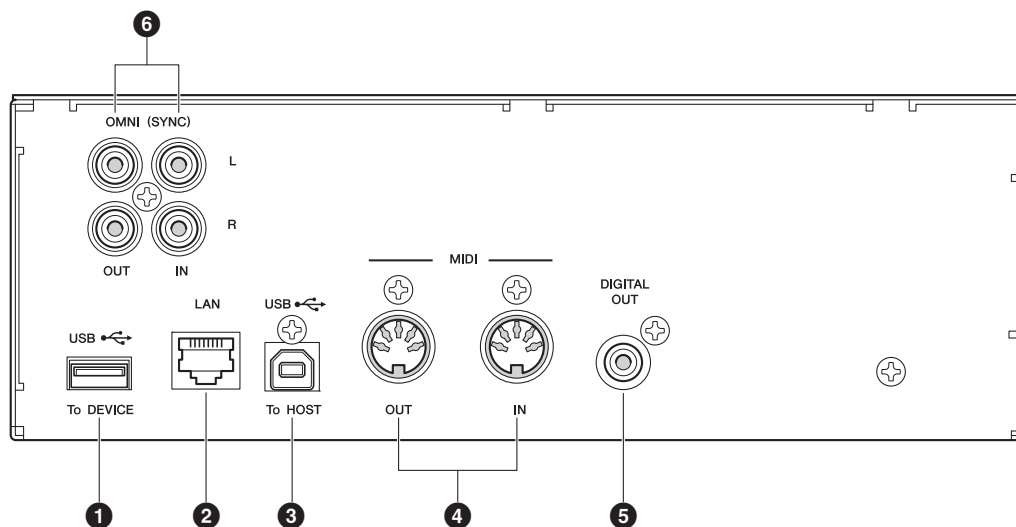

Side panel

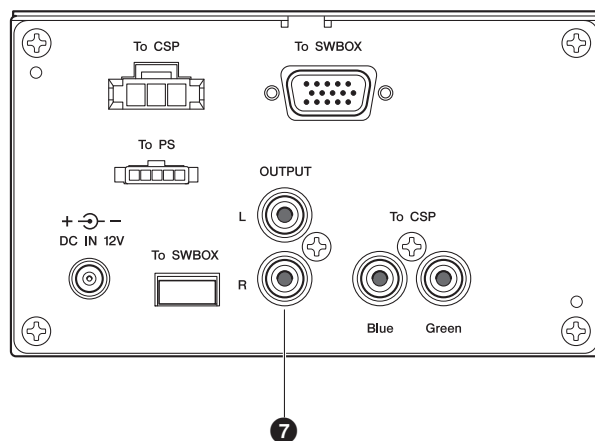
**1 [USB] (To DEVICE) terminal**

Used to connect the USB flash drive.

Note:

This product cannot detect the USB flash drive if two or more memory devices are connected at the same time.

2 [LAN] port

Used to connect the router or hub using an Ethernet cable.

3 [USB] (To HOST) terminal

Used to connect the computer using a USB cable.

4 [MIDI IN]/[MIDI OUT] jacks

Used to connect to the MIDI input or output jacks of external MIDI devices using MIDI cables.

5 [DIGITAL OUT] jack

Used to connect to the digital input jack of an external audio device using a digital coaxial cable.

6 [OMNI] (SYNC) [IN]/[OUT] jacks

Used to connect to the input or output jacks of external audio devices using RCA cables.

7 [OUTPUT] jacks

Used to connect the monitor speakers.

■ Inlet Box (for Upright Pianos)

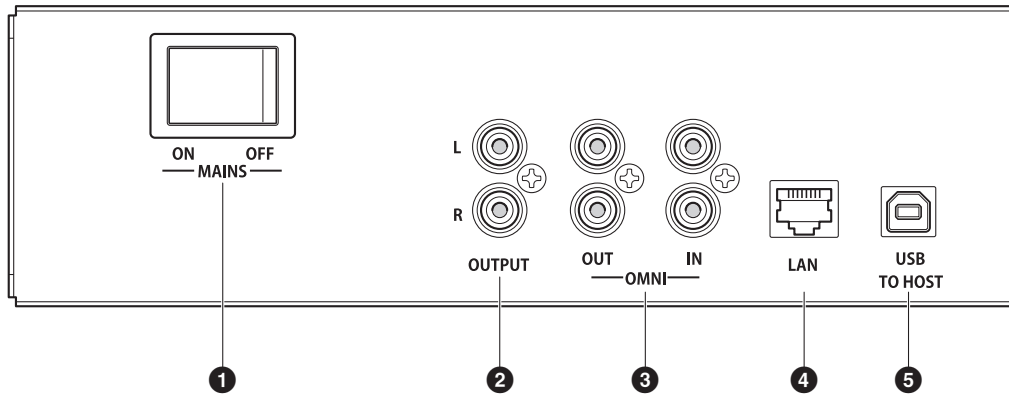

❶ [MAINS] switch

Turns on or off the main power.

❷ [OUTPUT] jacks

Used to connect optional monitor speakers.

❸ [OMNI] [IN]/[OUT] jacks

Used to connect to the input or output jacks of external audio devices using RCA cables.

❹ [LAN] port

Used to connect the router or hub using an Ethernet cable.

❺ [USB] (TO HOST) port

Used to connect the computer using a USB cable.

■ Monitor Speaker (for Grand Pianos)*

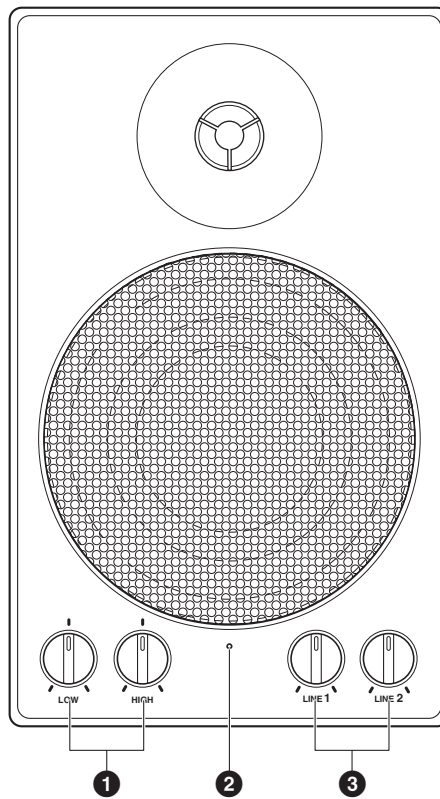

❶ LOW/HIGH volume controls

For adjusting the bass/treble sound volume.

❷ Power indicator

Lights up while the speaker is turned on.

❸ LINE 1/2 volume controls

For adjusting the sound volume of each line input.

Note:

For normal use, turn down the LINE 2 volume completely, and turn up the LINE 1 volume to the three o'clock position.

* Not supplied on some models.

Compatible Media and File Format

Compatible Device

USB Flash Drive

- The USB flash drive should be formatted in FAT16 or FAT32 file system.
- Check that the USB flash drive is free of memory and software protection before attempting to use it, as these kinds of protection will prohibit access to the memory.
- This product is USB 2.0 compliant. You can also connect USB 3.0 devices, however data will be transferred at USB 2.0 speeds.

Compatible File Formats

This product can handle these four types of file format:

Song Format	File Format	Extension
MIDI	SMF0 Standard MIDI File format 0 for playback and recording.	.MID
	SMF1 Standard MIDI File format 1 for playback only.	.MID
Audio	WAV Uncompressed audio file format commonly used to create standard audio CDs. This product can play back 44.1kHz/16bit stereo WAV files.	.WAV
	MP3 Compressed audio file format commonly used in computers and smart devices.	.MP3

Notice:

- Do not remove the USB flash drive or turn on or off the power during data transfer as breakage may result.
- Do not insert and remove the USB flash drive too frequently as breakage may result.
- Be careful not to bump the USB flash drive with your legs when it is connected to the unit.
- Do not insert any objects other than the USB flash drive into the USB terminal as it may become unusable.

Note:

Yamaha does not assure the operation of the commercially available USB flash drives.

Connecting the AC Power Cable

- 1 Connect the AC power cable extending from the piano to the AC wall outlet. This connection provides power to the autoplay piano.

Grand piano

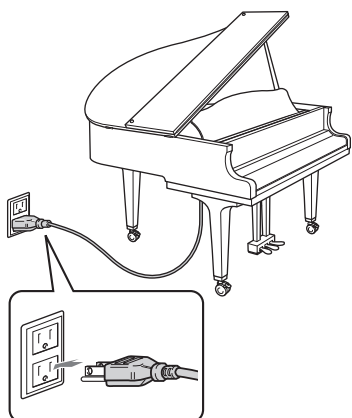

Upright piano

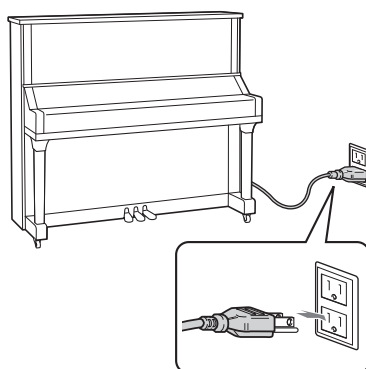

Warning:

- Use the AC power cable attached to the piano. Use of other AC power cables may result in damage, overheating, or fire.
- Do not stretch the cable or bend its ends.
- Do not attempt to use the cable if it is stretched or if the ends of the cable have been bent. Attempting to do so may cause interruptions to the power supply.

Caution:

- Always turn off the main unit power before disconnecting the AC power cable.
 - When you wish to move the piano, unplug the AC power cable from the AC outlet before proceeding.
- Unplug the AC power cable from the AC outlet if you do not intend to use the instrument for an extended period of time.

Connect powered speakers (Sold separately for Upright piano)

You can connect powered speakers to the [OUTPUT] jacks as illustrated.

* The audio cable should be 3m or less in length, and use an audio cable (conversion cable) that matches the shape of the INPUT LINE jack on the speaker side.

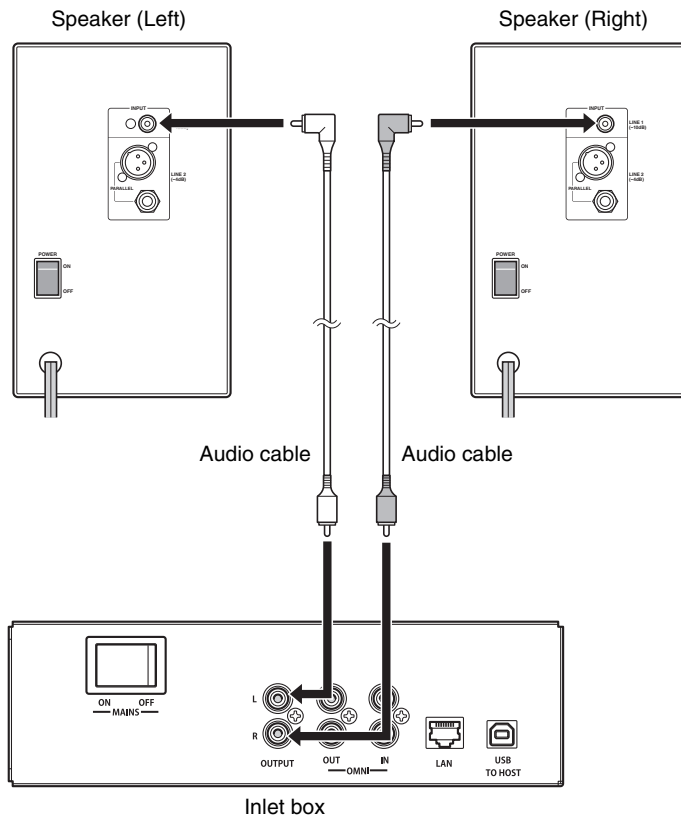

Notice:

To avoid possible damage to the devices, first turn on the power to this product, then to the external device.

When turning off the power, first turn off the power to the external device, then to this product.

Turning the Power On/Off

■ Turning the Power On

- 1 Make sure that the main switch on the power supply unit/inlet box is turned on.**

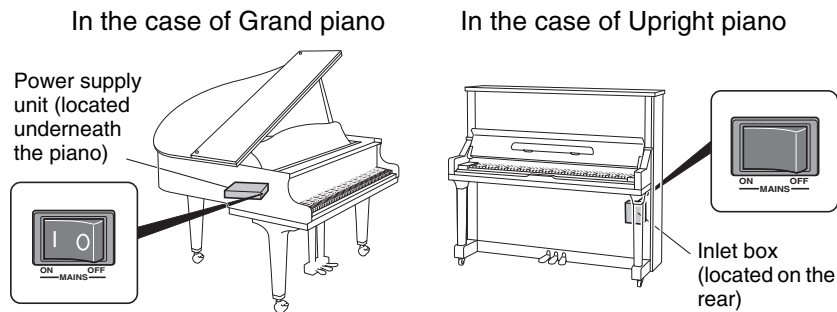

Under normal use, the power switch of the power supply unit remains on, but there is no problem, but if you do not use it for a long period of time or if you feel something wrong, turn off the power supply unit and turn the power cord from the outlet.

- 2 Press the [⏻] (Standby/On) button.**

The [⏻] indicator flashes slowly (every one second).

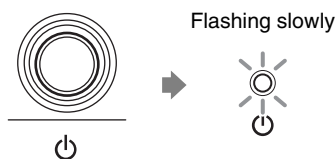

After several seconds, the [⏻] indicator lights up. This product is now ready for use.

■ Turning the Power Off (Standby)

- 1 Press the [⏻] (Standby/On) button.**

The [⏻] indicator flashes (every 0.5 seconds).



After several seconds, the [⏻] indicator lights up dimly.

■ Setting the Auto Off Function

You can turn the power off automatically if you do not use the product for the time specified with the ENSPIRE Controller app.

1 Set the [AUTO OFF MODE] switch on the rear of the switch box.



Setting	Description
ON	The auto off function is activated. The product is automatically turned off if you do not use it for the time specified with the ENSPIRE Controller app.
OFF	The auto off function is deactivated. Use the [⏻] (Standby/On) button to turn the power off.

Note:

When set to ON, this product automatically turns off under the following conditions:

- No operation is performed on the switch box.
- No operation is performed on the ENSPIRE Controller app.
- The keyboard is not being played.
- This product does not receive the MIDI data.

How to use the SILENT Piano™ Function (For Pianos Equipped with the SILENT Piano™ Function)

This product has the original mechanism of a piano that strikes strings with hammers, and also has a “SILENT Piano™ function” that effectively mutes the sound. When the sound is muted, the hammers inside the piano do not strike the strings, and the piano sound is heard entirely as electronic sound from powered speaker (in Quiet mode) or the headphones (in Headphone mode). The method of switching to each mode is as follows.

[Quiet Mode]

In this mode, the hammers do not strike the strings, and the piano sound can be heard from a powered speaker (Sold separately for upright piano). This is convenient when you wish to play with a quieter sound, etc.

[Headphone mode]

In this mode, the piano sound is entirely heard from the headphones, which is convenient when you do not wish to produce piano sound, such as when practicing at night.

■ SILENT Piano™ Function on Grand Piano

Quiet Mode

Perform this operation from the ENSPIRE Controller app (page 26). Switch the SILENT Piano™ function mode to Quiet with “Acoustic/Quiet” on the Balance screen within the app. (If the headphones are connected to the [HEADPHONE] jack, disconnect the headphones.)

Headphone mode

Connect the headphones to the [HEADPHONE] jack of the switch box to switch to Headphone mode.

■ SILENT Piano™ Function on Upright Piano

Quiet Mode

Press down the center pedal and slide it to the left to set to Quiet mode. (If the headphones are connected to the [HEADPHONE] jack, disconnect the headphones.)

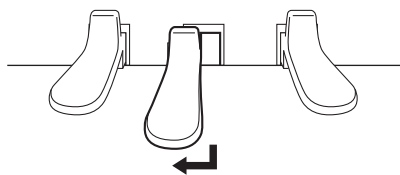

Headphone mode

Press down the center pedal and slide it to the left to set to Quiet mode, and then connect the headphones to the [HEADPHONE] jack of the switch box to switch to Headphone mode.

Note:

To use Quiet mode, a powered speaker (sold separately for upright piano) is required.

Note:

When headphones are connected, “Acoustic/Quiet” is automatically set to “Headphone.”

Connecting the Product and Smart Device to a Network

By connecting this product and smart device to a network, you can enjoy a variety of features through the Internet Direct Connection (IDC) services or control this product using your smart device (Please check “Installing the App” at the bottom of the page).

To fully control this product with the ENSPIRE Controller app, you must connect this product and smart device.
Here is the summary for connection:

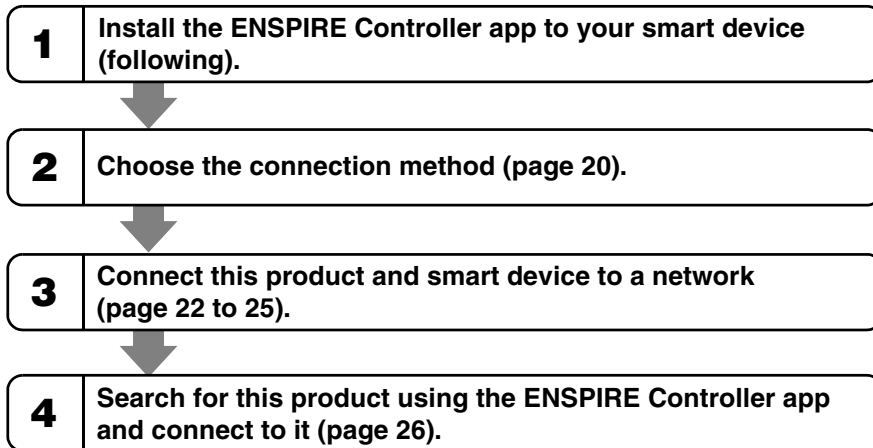

■ Preparations

- To use the Internet connection, you will first need to subscribe to an Internet service or provider.
- Use a computer to obtain and configure Internet service. You cannot obtain Internet service or configure router settings on a local area network using this product itself.

■ Installing the App

To connect your smart device to this product, you must install the ENSPIRE Controller app to your smart device.



For details, search for “ENSPIRE Controller” on the App Store or Google Play. For the ENSPIRE Controller app functions and operation instructions, refer to the Disklavier ENSPIRE Controller operation manual. The ENSPIRE Controller operation manual is located on the Information page within the ENSPIRE Controller app.

You can also download it from the website below.

<https://download.yamaha.com/>

Note:

- This product attempts to achieve a balance between security and usability in its network implementation. However, a determined hacker may be able to defeat these security measures and utilize the network of the purchaser in an unauthorized manner. Since each network is different, only the purchaser can determine whether the security measures discussed here will adequately protect their network.
- The purchaser acknowledges that connection to the Internet and use of this product Internet features is done at the risk of the purchaser. In no event shall Yamaha, its subsidiaries or Yamaha’s and/or its subsidiaries’ directors, officers, or employees be responsible for unauthorized access, loss or alteration of the data of the purchaser or be liable for any damage from intrusions.
- For the smart device, refer to the glossary (page 33).

Note:

- The application supports iOS and Android devices.
- For details on the application, refer to the description on the download site.

Choosing the Network Connection Method

You can use one of the three methods of connections below. Select one which is most suitable for your network environment.

■ Wireless Network Connection by WPS (👉 page 22)

Choose this if you have a wireless router (access point) that supports WPS. Connection will be established via a wireless router (access point).

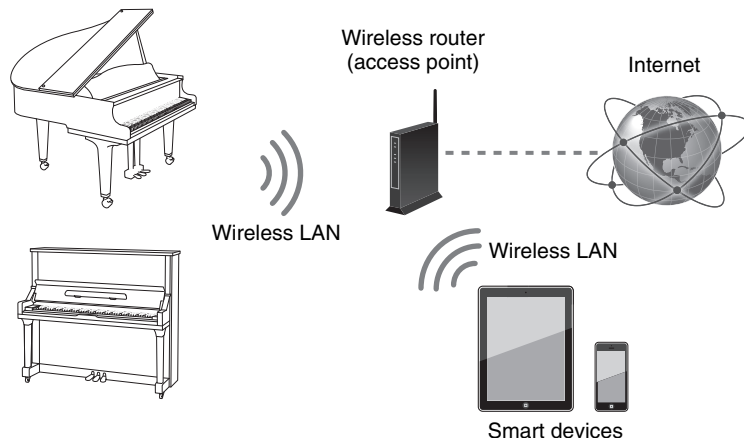

Requirements:

- USB wireless LAN adaptor (UD-WL01)
- Wireless router (access point) that supports WPS

WPS (Wi-Fi Protected Setup)

WPS is a wireless networking standard that makes connections between a router and wireless devices faster and easier. A router with WPS functionality is required to use WPS. Consult your wireless router (access point) specifications for compatibility information.

Note:

For the smart device, refer to the glossary (page 33).

■ Wired Network Connection (👉 page 24)

Choose this if you have a wireless router (access point) that does not support WPS. Connection will be established via wireless router (access point).

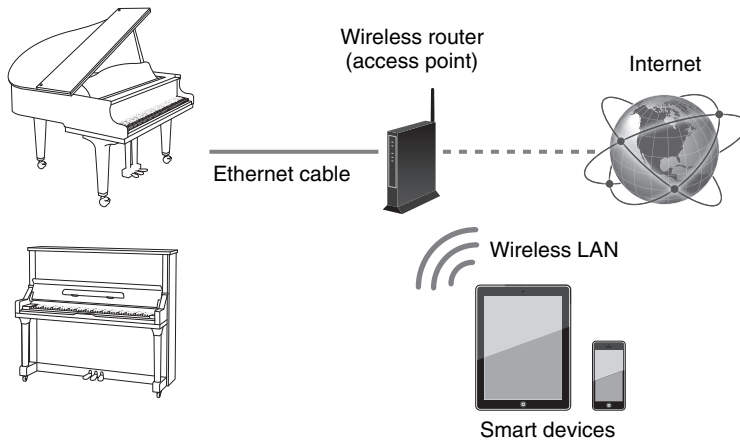

Requirements:

- Ethernet cable
- Wireless router (access point)

■ Direct Wireless Connection (👉 page 25)

Choose this if you do not have a wireless router (access point) or there is no wireless router (access point) available nearby. You can use this product as an access point to establish a direct wireless connection between this product and your smart device.

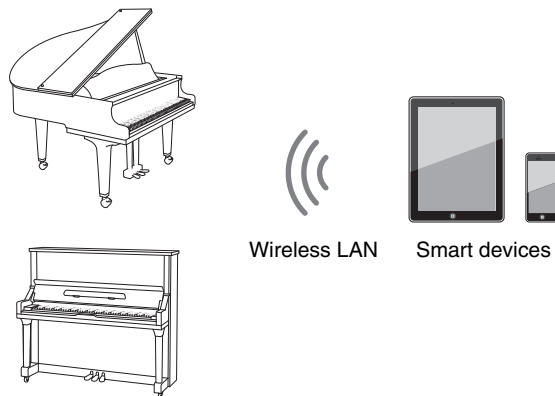

Requirements:

- USB wireless LAN adaptor (UD-WL01)

Note:

Use an STP (shielded twisted pair) cable for connection.

Notice:

Do not connect this product to public Wi-Fi and/or Internet directly. Only connect this product to the Internet through a router with strong password-protections. Consult your router manufacturer for information on security best practices

Note:

If this product is connected directly to your smart device, no Internet access is available on your smart device.

Wireless Network Connection by WPS

If your wireless router (access point) supports WPS, you can easily connect this product to a network just by following the procedures below, without making any additional settings, such as entering a password.

- 1** Press the [⏻] (Standby/On) button to turn the power off.
- 2** Connect the USB wireless LAN adaptor (UD-WL01) to the [USB] terminal on the rear of the switch box.

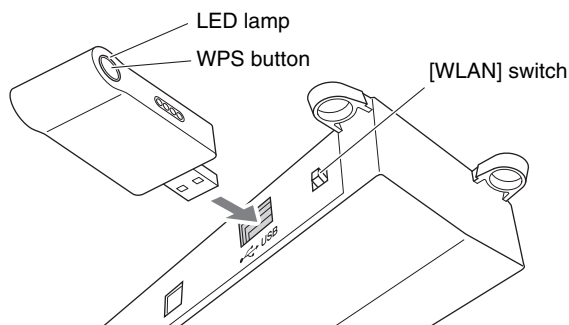

- 3** Check that the [WLAN] switch on the rear of the switch box is set to “RT.”

RT AP



WLAN

- 4** Press the [⏻] (Standby/On) button to turn the power on.
- 5** Hold down the WPS button on the USB wireless LAN adaptor (UD-WL01) for at least five seconds.

The LED lamp on the USB wireless LAN adaptor (UD-WL01) flashes every 0.5 seconds.

- 6** Press the WPS button on your wireless router (access point) within two minutes after step 5.

When this product is successfully connected to the wireless router (access point), the LED lamp on the USB wireless LAN adaptor (UD-WL01) lights up.

Connection between this product and the wireless router (access point) is now established. Once this product is connected to your wireless router (access point) by WPS, the setting will be remembered by this product, and you will not need to repeat this process the next time.

Note:

To check whether your wireless router (access point) supports WPS, refer to the owner's manual supplied with your wireless router (access point).

Note:

On powering up, the display may indicate an error message that flashes in red, reading “The wireless router (access point) is not found.” However, you can safely ignore the error, and proceed to step 5.

Note:

For details on the WPS setting, refer to the owner's manual supplied with your wireless router (access point).

Continue to the next page

- 7** Open the Wi-Fi setting screen on your smart device.
- 8** Enable the Wi-Fi function.
- 9** From the network list shown on the screen, tap on the network to which you connected this product.
If necessary, enter a password, and then connect.
- 10** Open the app and connect to the this product (page 26).

Note:

For details on the Wi-Fi setting, refer to the owner's manual supplied with your smart device.

Wired Network Connection

If your wireless router (access point) does not support WPS, you can connect this product to a wireless router (access point) using an Ethernet cable.

- 1** Press the [⏻] (Standby/On) button to turn the power off.
- 2** (For grand pianos) Connect the wireless router (access point) to the [LAN] port on the control center unit using an Ethernet cable.

■ Grand piano

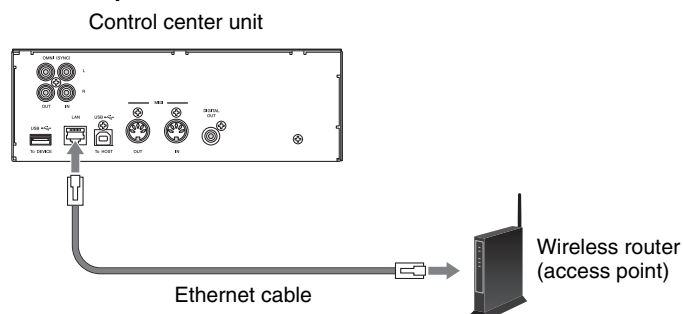

-
-
- (For upright pianos) Connect the wireless router (access point) to the LAN port on the inlet box using an Ethernet cable.

■ Upright piano

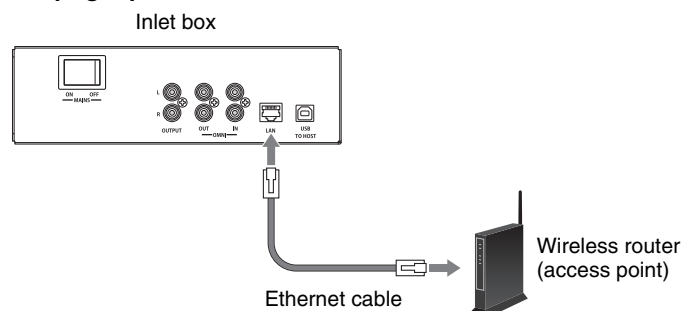

-
-
-
- 3** Enable the DHCP server function on the wireless router (access point).
- 4** Press the [⏻] (Standby/On) button to turn the power on.
Connection between this product and the wireless router (access point) is automatically established in approximately 15 to 20 seconds.
- 5** Open the Wi-Fi setting screen on your smart device.
- 6** Enable the Wi-Fi function.
- 7** From the displayed network list, tap the network to which this product is connected.
If necessary, enter a password, and then connect.
- 8** Open the app and connect to the this product (page 26).

Notice:

Do not connect this product to public Wi-Fi and/or Internet directly. Only connect this product to the Internet through a router with strong password-protections. Consult your router manufacturer for information on security best practices.

Note:

The inlet box is located on the rear of the piano.

Note:

For details on the DHCP setting, refer to the owner's manual supplied with your wireless router (access point).

Note:

For details on the Wi-Fi setting, refer to the owner's manual supplied with your smart device.

Direct Wireless Connection

You can use this product as an access point to establish a direct wireless connection between this product and your smart device.

- 1** Press the [⏻] (Standby/On) button to turn the power off.
- 2** Connect the USB wireless LAN adaptor (UD-WL01) to the [USB] terminal on the rear of the switch box.

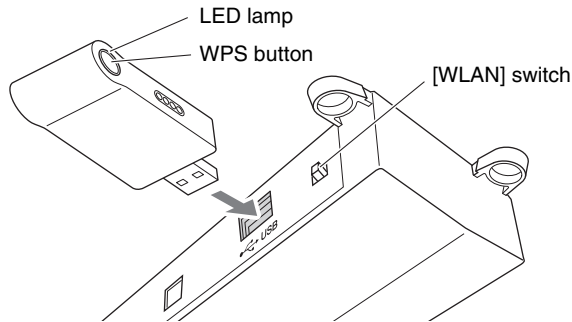

- 3** Set the [WLAN] switch on the rear of the switch box to “AP.”

RT AP



WLAN

- 4** Press the [⏻] (Standby/On) button to turn the power on.

When this product is set as an access point, the LED lamp of the USB wireless LAN adaptor (UD-WL01) lights up. You can now use this product as an access point.

- 5** Open the Wi-Fi setting screen on your smart device.

- 6** Enable the Wi-Fi function.

- 7** From the network list shown on the screen, tap on [DKV*****].

For Android

A dialog box window opens on the screen of the smart device and asks “This network has no internet access. Stay connected?”. Tap “Yes”.

- 8** Open the app and connect to the this product (page 26).

Note:

If this product is connected directly to your smart device, no Internet access is available on your smart device.

Note:

As a default, the [WLAN] switch is set to the “RT” position.

Note:

For details on the Wi-Fi setting, refer to the owner’s manual supplied with your smart device.

Note:

[DKV*****] differs depending on each Disklavier.

Using the ENSPIRE Controller App

■ Connect a smart device to this product

After you have connected your smart device to a network, open the ENSPIRE Controller app and select this product from the list. Tapping this product name will open the control screen of that Disklavier.

Display screen of ENSPIRE Controller app
"Select Disklavier"

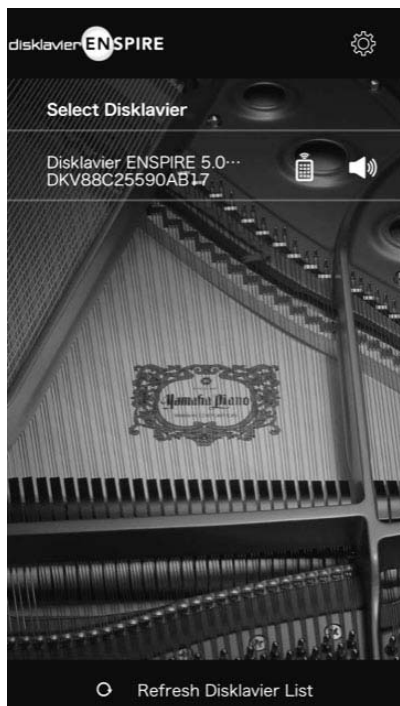

Display screen of ENSPIRE Controller app
"Control Screen"

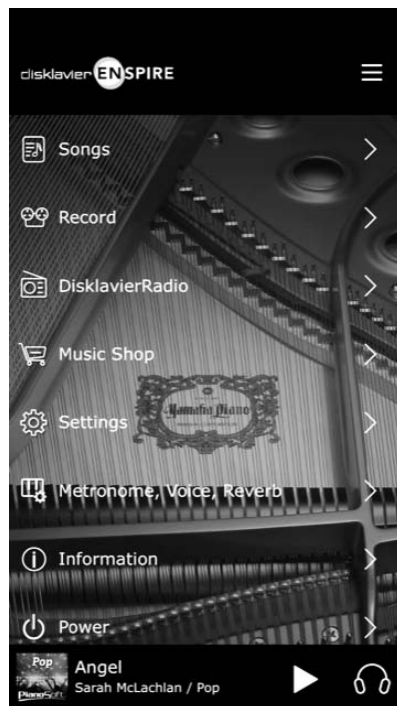

Note:

For the smart device, refer to the glossary (page 33).

Note:

When the speaker mark is tapped on the Select Disklavier ENSPIRE screen of the app, a chord (C-E-G) is automatically played one time for individual confirmation from the selected piano.

IDC Registration

To use the IDC service, initial registration is required using an Internet-connected computer.

Please register at the following website:

<https://member.yamaha.com/myproduct/regist/>

Once you have an IDC account, you will interact with that account using the ENSPIRE Controller app. To use the full IDC service, you are required to enter your registered ID (e-mail address) and password on the ENSPIRE Controller app.

Note:

- If you have already registered for the IDC service with any other instrument, you do not need to register again. You can use your ID and password obtained through that registration.
- Some IDC service functions do not require an ID and password.

Updating this product

Yamaha product firmware may occasionally be updated to improve functionality and operability. Certain functions may not be available with older firmware versions, so we recommend following the instructions below to update to the latest version.

1 Download the update program file.

You can download the update program from the following site:
<https://download.yamaha.com/>

2 Copy “en_update.bin” included in the downloaded file to the root directory of the USB flash drive.

3 Press the [⏻] (Standby/On) button to turn the power off.

4 Connect the USB flash drive to the [USB] terminal on the front of the switch box.

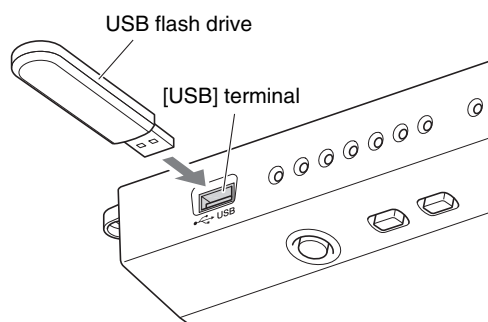

5 While holding down the [▶/⏸] (Play/Pause) button, press the [⏻] (Standby/On) button.

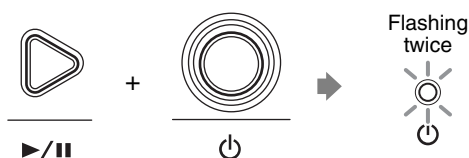

If any available update program is detected, this product starts to update. The update progress is indicated with the [- VOLUME +] indicators.



When the update is complete, this product restarts automatically. After this product restarts, check the firmware version using the ENSPIRE Controller app.

Note:

- To update this product, you will need a USB flash drive with 2GB or more of free space.
- You can also update this product using the ENSPIRE Controller app. To update this product using the app, Internet connection is required.

Note:

It is recommended that the USB flash drive only contains the update program file.

Notice:

DO NOT turn the power off or disconnect the USB flash drive during update.

Initializing Network Settings

If the ENSPIRE Controller app cannot connect to this product due to the improper network settings, follow the procedure below to initialize network settings on this product.

- 1** Press the [⏻] (Standby/On) button to turn the power off.
- 2** While holding down the [- VOLUME +] buttons, press the [⏻] (Standby/On) button.

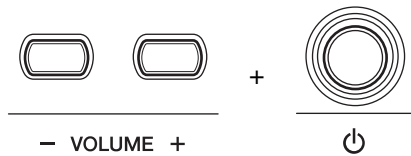

After this product is turned on, restart the ENSPIRE Controller app.

Troubleshooting

If you are having difficulty operating this product, see if any of the symptoms listed below apply to your problem and follow the recommended remedy.

Power

Symptom	Remedy
This product does not turn on.	Make sure that the main switch on the power supply unit is turned on.
	Make sure that the AC power cable is securely connected to a suitable AC wall outlet.
	If this product still cannot be turned on, disconnect it from the AC wall outlet, and consult your Yamaha piano dealer.

Switch Box

Symptom	Remedy
The switch box does not appear to work correctly.	Turn off the switch box, wait 5 seconds, then turn it back on. If the problem continues, consult your Yamaha piano dealer.
The switch box becomes hot.	The chassis of the switch box may become hot depending on usage conditions.

Monitor Speaker

Symptom	Remedy
No sound is heard from the monitor speaker.	Make sure that the POWER switch on the monitor speaker is turned on.
	Make sure that the monitor speaker is connected to the OUTPUT jacks on the control center unit with the supplied speaker cord.
	Make sure that the overall volume is adequately turned up.
	Make sure that the volume of the internal tone generator, audio and voice are adequately turned up.

Playback

Symptom	Remedy
This product does not read a song file.	Make sure that the name of the SMF song has the extension of ".mid" and the audio song has ".wav" or ".mp3."
Some notes drop out during playback.	When a piano song is played back at a low volume, complex note trills and faint pianissimo passages sometimes drop out. In such cases, increase this product volume level.

SILENT Piano™ Function (for pianos equipped with the SILENT Piano™ function)

Symptom	Remedy
Sound is not output properly or evenly.	Since the keyboard was pressed when the power is turned on, the keyboard position is detected incorrectly. Turn off the power and turn it on again to reset the function. Do not touch any keys when turning the power on.

Network

Symptom	Remedy
This product cannot connect to the Internet via a wireless router (access point).	Make sure that the wireless router (access point) is turned on.
	This product and the wireless router (access point) might be too far apart. Place this product and the wireless router (access point) closer to each other.
	There might be an obstacle between this product and the wireless router (access point). Move the wireless router (access point) to a location where there are no obstacles between them.
	If you connect this product and the wireless router (access point) using an Ethernet cable, enable the DHCP server function on your wireless router (access point).
Wireless network is not found.	Microwave ovens or other wireless devices in your network area might disturb the wireless communication. Turn off these devices.
	Access to the network is restricted by the firewall settings of the wireless router (access point). Check the firewall setting of the wireless router (access point).
WPS wireless network connection fails.	While setting up a wireless network connection using WPS, place this product and the wireless LAN router (access point) as close as possible.
The ENSPIRE Controller app does not detect this product.	This product and smart device are not on the same network. Check the network connections and settings on the wireless router (access point), and then connect this product and smart device to the same network.
A sudden sound comes from the piano when wireless connection to a smart device is used.	When the speaker mark is tapped on the Select Disklavier ENSPIRE screen of the app, a chord (C-E-G) is automatically played one time for individual confirmation from the selected piano. This is not a malfunction.

Error Indications

The error indicator may flash in red when some error has occurred. Refer to the table below for an explanation of the indication.

Example of Indication:

Flashing



Lighting up



Indication	Situation	Remedy
	Firmware update is failed.	Turn off the power of this product. Download the update program and try to update the firmware again. If the problem still persists, consult your Yamaha piano dealer.
	Two or more USB flash drives are connected at the same time.	You can use only one USB flash drive at a time. Disconnect the other USB flash drive.
	The USB flash drive is protected.	Unprotect the USB flash drive.
	The wireless router (access point) is not found.	Make sure that the wireless router (access point) is turned on. If you connect this product and the wireless router (access point) using an Ethernet cable, make sure that the cable is firmly connected to the wireless router (access point).
	This product cannot obtain the IP address.	Check the settings of your network devices.
	The piano control unit does not work properly.	Consult your Yamaha piano dealer. If you are using the ENSPIRE Controller app, please tell them the message on the screen.

- Error message also appears on the control screen of the ENSPIRE Controller app. To close the message, tap on "Close" on the pop-up.
- Pressing any of [- VOLUME +] or [▶/||] (Play/Pause) buttons turns off the error indicator, and the [- VOLUME +] indicators return to the previous status.

Glossary

This glossary provides basic definitions of terms used frequently in this manual.

DHCP

This is a standard or protocol by which IP addresses and other low-level network configuration information can be dynamically and automatically assigned each time a connection is made to the Internet.

Ensemble Song

A song which contains piano parts and accompanying instrumental voices. An ensemble song contains the same left- and right-hand parts as an L/R song, and in addition, up to 13 accompanying instrument tracks. These extra tracks are played by the internal XG tone generator. The accompanying tracks may be used for acoustic bass, drums, strings, vibes, etc.

General MIDI (GM)

An addition to the MIDI standard that simplifies the transfer of MIDI song files between instruments of different manufacturers. A MIDI song recorded using a GM compatible tone generator should play back correctly when used with any GM compatible tone generator. The standard specifies that a GM compatible tone generator must support 24-note polyphony, 16 parts, and 128 standard voices.

Internet

A huge network made up of networks, the Internet allows high-speed data transfer among computers, mobile phones and other devices.

Internet Direct Connection (IDC)

Internet Direct Connection (IDC) is a feature that allows you to connect this product directly to the Internet. IDC users are able to listen to a streaming broadcast (DisklavierRadio), and receive valuable information such as product updates. This product can be upgraded remotely as new technologies and services are developed through the IDC service.

ISP (Internet Service Provider)

A communications business that offers Internet connection services. In order to connect to the Internet, it is necessary to have active service with an Internet service provider.

LAN

Short for Local Area Network, this is a data-transfer network that connects a group of computers at a single location (such as an office or home) by means of a special cable.

MIDI

An acronym for Musical Instrument Digital Interface. MIDI allows electronic musical instruments to communicate with each other.

PianoSoft™

PianoSoft software contains prerecorded songs made by Yamaha specifically for use with this product.

PianoSoftAudio

PianoSoftAudio software contains real audio and MIDI signals for playing back on this product.

PianoSoftPlus™

PianoSoftPlus software contains Ensemble songs that can be played on this product.

Polyphony

The maximum number of voices (or sounds) that can be produced at a time from MIDI instruments.

Router

A device for connecting multiple computer networks. For example, a router is necessary when connecting several computers in a house or office, to allow all of them access the Internet and share data. A router is usually connected between a modem and a computer, although some modems have a built-in router.

Smart Device

This refers to portable multi-functional terminals such as smartphones and tablet terminals that can use the Internet connection and application software.

Song

Normally, a short piece of music with lyrics. However, for clarity in Disklavier manuals, the term is used to refer to any piece of music of any genre.

Standard MIDI File (SMF)

A file of MIDI data that can be read and used by a number of different MIDI devices and computers.

USB

An interface for connecting an external “plug and play” device. This product is equipped with three TO DEVICE terminals with USB 2.0 standard and one TO HOST terminal. An external storage device, such as USB flash drive, can be used with this product by connecting it to a TO DEVICE terminal. Also this product enables you to enjoy a variety of MIDI features by connecting a computer to TO HOST terminal.

Voice

The sounds produced by a tone generator expressing various instruments.

Wi-Fi

Wi-Fi (Wireless Fidelity) is a technology that allows an electronic device to exchange data or connect to the Internet wirelessly using radio waves. Wi-Fi offers the advantage of eliminating the complexity of making connections with network cables by using wireless connection. Only products that complete Wi-Fi Alliance interoperability tests can carry the “Wi-Fi Certified” trademark.

WPS

WPS (Wi-Fi Protected Setup) is a standard established by the Wi-Fi Alliance, which allows easy establishment of a wireless home network.

XG

Yamaha XG is an extension of the GM (General MIDI) format. Its greater polyphony, more voices, and use of effects enhances the compatibility between MIDI devices. When a song in the Yamaha XG format is played on another XG-compatible tone generator or synthesizer, it plays and sounds as the original composer/creator intended.

General Specifications

Type		ST		PRO
Piano		Grand Piano	Upright Piano	Grand Piano
Sensor System	Key Sensors	Non-contact optical fiber grayscale shutter sensing system for 88 keys (sensors for the key position, keying velocity, and key releasing velocity)		
	Hammer Sensors	Non-contact optical fiber/shutter sensing system ¹		Non-contact optical fiber/ grayscale sensing system
	Pedal Sensors	Damper & shift pedals: Non-contact optical position-sensing system Sostenuto pedal: ON / OFF detection sensing system	Damper & soft pedals: Non-contact optical position-sensing system	Damper & shift pedals: Non-contact digital optical position-sensing system Sostenuto pedal: ON / OFF detection sensing system
Drive System	Key Drive	DSP servo drive system (servo-controlled solenoids, key sensor feedback)		DSP servo drive system (high-power servo-controlled solenoids with supersensitive magnetic sensor, key/ hammer sensor feedback)
	Pedal Drive	DSP servo drive system (servo-controlled solenoids)		
Silencing System ²		Motor-driven hammer shank stopper		
Compatible Storage Media		USB flash drive		
Built-in Songs		500 songs		
Compatible File Formats		Standard MIDI File (SMF) format 0, Standard MIDI File (SMF) format 1, WAV, MP3		
Compatible Song Formats		PianoSoft, PianoSoftPlus, PianoSoftAudio, SmartKey		
Switch Box	Buttons	POWER  , VOLUME -/+, PLAY/PAUSE, MAINTENANCE		
	Switches	AUTO PLAY, AUTO OFF MODE, WLAN		
	Dimension (W x D x H)	220 x 70 x 30 mm (8-11/16 x 2-3/4 x 1-3/16 inch)		
Control Center Unit	Dimension (W x D x H)	224 x 130 x 76 mm (8-13/16 x 5-1/8 x 3 inch)		
Connectors	MIDI	MIDI IN, MIDI OUT	—	MIDI IN, MIDI OUT
	Audio	OUTPUT, OMNI (SYNC) IN, OMNI (SYNC) OUT, DIGITAL OUT, HEADPHONE (mini)	OUTPUT, OMNI (SYNC) IN, OMNI (SYNC) OUT, HEADPHONE (mini)	OUTPUT, OMNI (SYNC) IN, OMNI (SYNC) OUT, DIGITAL OUT, HEADPHONE (mini)
	Others	LAN, USB (To HOST x 1, To DEVICE x 3)	LAN, USB (To HOST x 1, To DEVICE x 2)	LAN, USB (To HOST x 1, To DEVICE x 3)
Tone Generator	Piano Sound	CFX Binaural Sampling, CFX Stereo Sampling		
	Pitch Control	414.8 Hz to 466.8 Hz (tunable in 0.2 Hz increments)		
	Polyphony	256 notes (max.)		
	Voices for Playing	16 Voices (Piano, Electric Piano 1, Electric Piano 2, Electric Piano 3, Harpsichord 1, Harpsichord 2, Vibraphone, Celesta, Pipe Organ 1, Pipe Organ 2, Pipe Organ 3, Pipe Organ 4, Jazz Organ, Strings, Choir, Synth Pad)		
	Voice Module Modes	XG, GM		
	Normal Voices	480 Voices		
	Drum Kits	12 kits		

Type	ST		PRO
Piano	Grand Piano	Upright Piano	Grand Piano
Power Source	AC 100 V to 240 V, 50/60 Hz		
Supplied Accessories	Monitor speaker (2) ^{*3} , Monitor speaker installation kit (2) ^{*3} , Stereo headphones (1), Owner's manual (1), Built-in song list (1), Music book "50 greats for the Piano" (1), USB wireless LAN adaptor (1)	Stereo headphones (1), Owner's manual (1), Built-in song list (1), Music book "50 greats for the Piano" (1), USB wireless LAN adaptor (1)	Monitor speaker (2) ^{*3} , Monitor speaker installation kit (2) ^{*3} , Stereo headphones (1), Owner's manual (1), Built-in song list (1), Music book "50 greats for the Piano" (1), USB wireless LAN adaptor (1)

*1 Not equipped on some models.

*2 ST-type grand pianos may not have a SILENT Piano™ function.

*3 Not supplied on some models.

Specifications are subject to change without prior notice.

MEMO

disklavier **ENSPIRE™**

**ST
PRO**

Appendix

XG Voice List

Voice Group	Voice Name	MSB	LSB	PRG	Element	
Piano	GrandPiano	0	0	1	2*	
	GrndPianoKSP	0	1	1	1	
	MellowGrPno	0	18	1	2	
	PianoStrings	0	40	1	2	
	Dream	0	41	1	2	
	BrightPiano	0	0	2	2	
	BritePnoKSP	0	1	2	1	
	ElecGrandPno	0	0	3	2	
	ElecGrPnoKSP	0	1	3	2	
	DetunedCP80	0	32	3	2	
	LayeredCP1	0	40	3	2	
	LayeredCP2	0	41	3	2	
	Honkytonk	0	0	4	2	
	HonkytonkKSP	0	1	4	2	
	El.Piano1	0	0	5	2	
	El.Piano1KSP	0	1	5	1	
	MellowEP1	0	18	5	2	
	ChorusEP1	0	32	5	2	
	HardEl.Piano	0	40	5	2	
	VXfadeEl.P1	0	45	5	2	
	60sEl.Piano1	0	64	5	1	
	El.Piano2	0	0	6	2	
	El.Piano2KSP	0	1	6	1	
	ChorusEP2	0	32	6	2	
	DXEPHard	0	33	6	2	
	DXLegend	0	34	6	2	
	DXPhaseEP	0	40	6	2	
	DX+AnalogEP	0	41	6	2	
	DXKotoEP	0	42	6	2	
	VXfadeEl.P2	0	45	6	2	
	Harpsichord	0	0	7	1	
	Harpsi.KSP	0	1	7	1	
	Harpsichord2	0	25	7	2	
	Harpsichord3	0	35	7	2	
	Clavi.	0	0	8	1	
	Clavi.KSP	0	1	8	1	
	Clavi.Wah	0	27	8	2	
	PulseClavi.	0	64	8	1	
	PierceClavi.	0	65	8	2	
	Chromatic Percussion	Celesta	0	0	9	1
		Glockenspiel	0	0	10	1
		MusicBox	0	0	11	2
		Orgel	0	64	11	2
		Vibraphone	0	0	12	1
		VibesKSP	0	1	12	1
		HardVibes	0	45	12	2
		Marimba	0	0	13	1
		MarimbaKSP	0	1	13	1
		SineMarimba	0	64	13	2
		Balimba	0	97	13	2
		LogDrums	0	98	13	2
		Xylophone	0	0	14	1
		TubularBells	0	0	15	1
		ChurchBells	0	96	15	2
		Carillon	0	97	15	2
Dulcimer		0	0	16	1	
Dulcimer2		0	35	16	2	
Cimbalom		0	96	16	2	
Santur		0	97	16	2	
Organ		DrawbarOrgan	0	0	17	1
		DetDrawOrgan	0	32	17	2
		60sDrawOrg1	0	33	17	2
	60sDrawOrg2	0	34	17	2	
	70sDrawOrg1	0	35	17	2	
	DrawbarOrg2	0	36	17	2	
	60sDrawOrg3	0	37	17	2	
	EvenBarOrg	0	38	17	2	
	16+2'2_3Org	0	40	17	2	
	OrganBass	0	64	17	1	
	70sDrawOrg2	0	65	17	2	
	ChezyOrgan	0	66	17	2	
	DrawbarOrg3	0	67	17	2	
	Perc.Organ	0	0	18	1	
	70sPercOrg1	0	24	18	2	
	DetPercOrgan	0	32	18	2	
	LightOrgan	0	33	18	2	

* The number of elements becomes 4 when the damper pedal is pressed.

Voice Group	Voice Name	MSB	LSB	PRG	Element	
Organ	Perc.Organ2	0	37	18	2	
	RockOrgan	0	0	19	1	
	RotaryOrgan	0	64	19	2	
	SlowRotary	0	65	19	2	
	FastRotary	0	66	19	2	
	ChurchOrgan	0	0	20	2	
	ChurchOrgan3	0	32	20	2	
	ChurchOrgan2	0	35	20	2	
	NotreDame	0	40	20	2	
	OrganFlute	0	64	20	2	
	Trem.OrganFl	0	65	20	2	
	ReedOrgan	0	0	21	1	
	PuffOrgan	0	40	21	2	
	Accordion	0	0	22	1	
	AccordIt	0	32	22	2	
	Harmonica	0	0	23	1	
	Harmonica2	0	32	23	2	
	TangoAccord	0	0	24	1	
	TangoAccord2	0	64	24	2	
	Guitar	NylonGuitar	0	0	25	1
		NylonGuitar2	0	16	25	1
		NylonGuitar3	0	25	25	2
		VelGtrHarmo	0	43	25	1
		Ukulele	0	96	25	1
		SteelGuitar	0	0	26	1
SteelGuitar2		0	16	26	1	
12StrGuitar		0	35	26	2	
Nylon&Steel		0	40	26	2	
Steel&Body		0	41	26	2	
Mandolin		0	96	26	2	
JazzGuitar		0	0	27	1	
MellowGuitar		0	18	27	1	
JazzAmp		0	32	27	2	
CleanGuitar		0	0	28	1	
ChorusGuitar		0	32	28	2	
MutedGuitar		0	0	29	1	
FunkGuitar1		0	40	29	2	
MuteSteelGtr		0	41	29	2	
FunkGuitar2		0	43	29	1	
JazzMan		0	45	29	2	
Overdriven		0	0	30	1	
GuitarPinch		0	43	30	1	
Distortion		0	0	31	1	
FeedbackGtr		0	40	31	2	
FeedbackGtr2		0	41	31	2	
GtrHarmonics		0	0	32	1	
GtrFeedback		0	65	32	1	
GtrHarmonic2		0	66	32	1	
Bass		AcousticBass	0	0	33	1
	JazzRhythm	0	40	33	2	
	VXUprghtBass	0	45	33	2	
	FingerBass	0	0	34	1	
	FingerDark	0	18	34	2	
	FlangeBass	0	27	34	2	
	Bass&DistEG	0	40	34	2	
	FingerSlap	0	43	34	1	
	FingerBass2	0	45	34	2	
	Mod.Bass	0	65	34	2	
	PickBass	0	0	35	1	
	MutePickBass	0	28	35	1	
	FretlessBass	0	0	36	1	
	Fretless2	0	32	36	2	
	Fretless3	0	33	36	2	
	Fretless4	0	34	36	2	
	Syn.Fretless	0	96	36	2	
	SmthFretless	0	97	36	2	
	SlapBass1	0	0	37	1	
	ResonantSlap	0	27	37	1	
	PunchThumb	0	32	37	2	
	SlapBass2	0	0	38	1	
	Velo.Sw.Slap	0	43	38	1	
	SynthBass1	0	0	39	1	
	SynBass1Dark	0	18	39	1	
FastResoBass	0	20	39	1		
AcidBass	0	24	39	1		
ClaviBass	0	35	39	2		

XG Voice List

Voice Group	Voice Name	MSB	LSB	PRG	Element	
Bass	TechnoBass	0	40	39	2	
	Orbiter	0	64	39	2	
	SquareBass	0	65	39	1	
	RubberBass	0	66	39	2	
	Hammer	0	96	39	2	
	SynthBass2	0	0	40	2	
	MellowSyBass	0	6	40	1	
	SequenceBass	0	12	40	2	
	ClickSynBass	0	18	40	2	
	SynBass2Dark	0	19	40	1	
	SmoothSyBass	0	32	40	2	
	ModulrSyBass	0	40	40	2	
	DXBass	0	41	40	2	
	XWireBass	0	64	40	2	
Strings	Violin	0	0	41	1	
	SlwAtkViolin	0	8	41	1	
	Viola	0	0	42	1	
	Cello	0	0	43	1	
	Contrabass	0	0	44	1	
	Trem.Strings	0	0	45	1	
	SlwAtTremStr	0	8	45	1	
	SuspenseStr	0	40	45	2	
	PizzicatoStr	0	0	46	1	
	Orch.Harp	0	0	47	1	
	YangChin	0	40	47	2	
	Timpani	0	0	48	1	
	Ensemble	Strings1	0	0	49	1
		StereoStrngs	0	3	49	2
SlwAtkStrngs		0	8	49	1	
ArcoStrings		0	24	49	2	
60'sStrings		0	35	49	2	
Orchestra		0	40	49	2	
Orchestra2		0	41	49	2	
TremOrchestra		0	42	49	2	
Velo.Strings		0	45	49	2	
Strings2		0	0	50	1	
S.SlowStrngs		0	3	50	2	
LegatoStrngs		0	8	50	2	
WarmStrings		0	40	50	2	
Kingdom		0	41	50	2	
70'sStrings		0	64	50	1	
Strings3		0	65	50	1	
SynStrings1		0	0	51	2	
ResoStrings		0	27	51	2	
SynStrings4		0	64	51	2	
SynStrings5		0	65	51	2	
SynStrings2		0	0	52	2	
ChoirAahs		0	0	53	1	
StereoChoir		0	3	53	2	
ChoirAahs2		0	16	53	2	
MellowChoir		0	32	53	2	
ChoirStrings		0	40	53	2	
VoiceOohs		0	0	54	1	
SynthVoice		0	0	55	1	
SynthVoice2		0	40	55	2	
Choral		0	41	55	2	
AnalogVoice		0	64	55	1	
OrchestraHit		0	0	56	2	
OrchestrHit2		0	35	56	2	
Impact		0	64	56	2	
Brass	Trumpet	0	0	57	1	
	Trumpet2	0	16	57	1	
	BriteTrumpet	0	17	57	2	
	WarmTrumpet	0	32	57	2	
	Trombone	0	0	58	1	
	Trombone2	0	18	58	2	
	Tuba	0	0	59	1	
	Tuba2	0	16	59	1	
	MutedTrumpet	0	0	60	1	
	FrenchHorn	0	0	61	1	
	Fr.HornSolo	0	6	61	1	
	FrenchHorn2	0	32	61	2	
	HornOrchestr	0	37	61	2	
	BrassSection	0	0	62	1	
	Tp&TbSection	0	35	62	2	
	BrassSect2	0	40	62	2	
	HighBrass	0	41	62	2	
	MellowBrass	0	42	62	2	
	SynthBrass1	0	0	63	2	
	QuackBrass	0	12	63	2	
	ResoSynBrass	0	20	63	2	
	PolyBrass	0	24	63	2	

Voice Group	Voice Name	MSB	LSB	PRG	Element	
Brass	SynthBrass3	0	27	63	2	
	JumpBrass	0	32	63	2	
	AnaVelBrass1	0	45	63	2	
	AnalogBrass1	0	64	63	2	
	SynthBrass2	0	0	64	1	
	SoftBrass	0	18	64	2	
	SynthBrass4	0	40	64	2	
	ChoirBrass	0	41	64	2	
	AnaVelBrass2	0	45	64	2	
	AnalogBrass2	0	64	64	2	
Reed	SopranoSax	0	0	65	1	
	AltoSax	0	0	66	1	
	SaxSection	0	40	66	2	
	HyperAltoSax	0	43	66	1	
	TenorSax	0	0	67	1	
	BreathyTenor	0	40	67	2	
	SoftTenorSax	0	41	67	2	
	TenorSax2	0	64	67	1	
	BaritoneSax	0	0	68	1	
	Oboe	0	0	69	1	
	EnglishHorn	0	0	70	1	
	Bassoon	0	0	71	1	
	Clarinet	0	0	72	1	
	Pipe	Piccolo	0	0	73	1
Flute		0	0	74	1	
Recorder		0	0	75	1	
PanFlute		0	0	76	1	
BlownBottle		0	0	77	2	
Shakuhachi		0	0	78	1	
Whistle		0	0	79	1	
Ocarina		0	0	80	1	
Synth. Lead		SquareLead	0	0	81	2
		SquareLead2	0	6	81	1
	LMSquare	0	8	81	2	
	Hollow	0	18	81	1	
	Shroud	0	19	81	2	
	Mellow	0	64	81	2	
	SoloSine	0	65	81	2	
	SineLead	0	66	81	1	
	SawtoothLead	0	0	82	2	
	SawtoothLd2	0	6	82	1	
	ThickSaw	0	8	82	2	
	DynamicSaw	0	18	82	1	
	DigitalSaw	0	19	82	2	
	BigLead	0	20	82	2	
	HeavySynth	0	24	82	2	
	WaspySynth	0	25	82	2	
	PulseSaw	0	40	82	2	
	Dr.Lead	0	41	82	2	
	VelocityLead	0	45	82	2	
	Seq.Analog	0	96	82	2	
	CalliopeLead	0	0	83	2	
	PureLead	0	65	83	2	
	ChiffLead	0	0	84	2	
	Rubby	0	64	84	2	
	CharangLead	0	0	85	2	
	DistortedLd	0	64	85	2	
	WireLead	0	65	85	2	
	VoiceLead	0	0	86	2	
	SynthAahs	0	24	86	2	
	VoxLead	0	64	86	2	
	FifthsLead	0	0	87	2	
	BigFive	0	35	87	2	
	Bass&Lead	0	0	88	2	
	Big&Low	0	16	88	2	
Fat&Perky	0	64	88	2		
SoftWhirl	0	65	88	2		
Synth. Pad	NewAgePad	0	0	89	2	
	Fantasy	0	64	89	2	
	WarmPad	0	0	90	2	
	ThickPad	0	16	90	2	
	SoftPad	0	17	90	2	
	SinePad	0	18	90	2	
	HornPad	0	64	90	2	
	RotaryStrngs	0	65	90	2	
	PolySynthPad	0	0	91	2	
	PolyPad80	0	64	91	2	
	ClickPad	0	65	91	2	
	AnalogPad	0	66	91	2	
	SquarePad	0	67	91	2	
	ChoirPad	0	0	92	2	
Heaven	0	64	92	2		

Voice Group	Voice Name	MSB	LSB	PRG	Element	
Synth. Pad	Itopia	0	66	92	2	
	CCPad	0	67	92	2	
	BowedPad	0	0	93	2	
	Glacier	0	64	93	2	
	GlassPad	0	65	93	2	
	MetallicPad	0	0	94	2	
	TinePad	0	64	94	2	
	PanPad	0	65	94	2	
	HaloPad	0	0	95	2	
	SweepPad	0	0	96	2	
	Shwimmer	0	20	96	2	
	Converge	0	27	96	2	
	PolarPad	0	64	96	2	
	Celestial	0	66	96	2	
	Synth. Effects	Rain	0	0	97	2
		ClaviPad	0	45	97	2
HarmoRain		0	64	97	2	
AfricanWind		0	65	97	2	
Carib		0	66	97	2	
SoundTrack		0	0	98	2	
Prologue		0	27	98	2	
Ancestral		0	64	98	2	
Crystal		0	0	99	2	
SynthDr.Comp		0	12	99	2	
Popcorn		0	14	99	2	
TinyBells		0	18	99	2	
RoundGlocken		0	35	99	2	
GlockenChime		0	40	99	2	
ClearBells		0	41	99	2	
ChorusBells		0	42	99	2	
SynthMallet		0	64	99	1	
SoftCrystal		0	65	99	2	
LoudGlocken		0	66	99	2	
ChristmasBel		0	67	99	2	
VibeBells		0	68	99	2	
DigitalBells		0	69	99	2	
AirBells		0	70	99	2	
BellHarp		0	71	99	2	
Gamelimba		0	72	99	2	
Atmosphere		0	0	100	2	
WarmAtmos.		0	18	100	2	
HollwRelease		0	19	100	2	
NylonEIPiano		0	40	100	2	
NylonHarp		0	64	100	2	
HarpVox		0	65	100	2	
Atmos.Pad		0	66	100	2	
Planet		0	67	100	2	
Brightness		0	0	101	2	
FantasyBells		0	64	101	2	
Smockey		0	96	101	2	
Goblins		0	0	102	2	
GoblinsSynth		0	64	102	2	
Creepier		0	65	102	2	
RingPad		0	66	102	2	
Ritual		0	67	102	2	
ToHeaven		0	68	102	2	
Night		0	70	102	2	
Glisten		0	71	102	2	
BellChoir		0	96	102	2	
Echoes		0	0	103	2	
Echoes2		0	8	103	2	
EchoPan		0	14	103	2	
EchoBells		0	64	103	2	
BigPan		0	65	103	2	
SynthPiano	0	66	103	2		
Creation	0	67	103	2		
StarDust	0	68	103	2		
Reso&Panning	0	69	103	2		
Sci-Fi	0	0	104	2		
Starz	0	64	104	2		
Ethnic	Sitar	0	0	105	1	
	DetunedSitar	0	32	105	2	
	Sitar2	0	35	105	2	
	Tambra	0	96	105	2	
	Tamboura	0	97	105	2	
	Banjo	0	0	106	1	
	MutedBanjo	0	28	106	1	
	Rabab	0	96	106	2	
	Gopichant	0	97	106	2	
	Oud	0	98	106	2	
	Shamisen	0	0	107	1	
	Koto	0	0	108	1	

Voice Group	Voice Name	MSB	LSB	PRG	Element	
Ethnic	Taisho-kin	0	96	108	2	
	Kanoon	0	97	108	2	
	Kalimba	0	0	109	1	
	Bagpipe	0	0	110	2	
	Fiddle	0	0	111	1	
	Shanai	0	0	112	1	
	Shanai2	0	64	112	1	
	Pungi	0	96	112	1	
	Hichiriki	0	97	112	2	
	Percussive	TinkleBell	0	0	113	2
		Bonang	0	96	113	2
		Altair	0	97	113	2
		GamelanGongs	0	98	113	2
		StereoGamlan	0	99	113	2
RamaCymbal		0	100	113	2	
AsianBells		0	101	113	2	
Agogo		0	0	114	2	
SteelDrums		0	0	115	1	
GlassPerc.		0	97	115	2	
ThaiBells		0	98	115	2	
Woodblock		0	0	116	1	
Castanets		0	96	116	1	
TaikoDrum		0	0	117	1	
GranCassa		0	96	117	1	
MelodicTom		0	0	118	2	
MelodicTom2		0	64	118	1	
RealTom		0	65	118	2	
RockTom		0	66	118	2	
SynthDrum		0	0	119	1	
AnalogTom	0	64	119	1		
ElectroPerc.	0	65	119	2		
Rev.Cymbal	0	0	120	1		
Sound Effects	GtrFretNoise	0	0	121	1	
	BreathNoise	0	0	122	1	
	Seashore	0	0	123	2	
	BirdTweet	0	0	124	2	
	TelephonRing	0	0	125	1	
	Helicopter	0	0	126	1	
	Applause	0	0	127	1	
	Gunshot	0	0	128	1	
	SFX	CuttingNoise	64	0	1	1
		CuttingNoiz2	64	0	2	2
StringSlap		64	0	4	1	
Fl.KeyClick		64	0	17	1	
Shower		64	0	33	1	
Thunder		64	0	34	1	
Wind		64	0	35	1	
Stream		64	0	36	2	
Bubble		64	0	37	2	
Feed		64	0	38	2	
Dog		64	0	49	1	
Horse		64	0	50	1	
BirdTweet2		64	0	51	1	
Ghost		64	0	55	2	
Maou		64	0	56	2	
PhoneCall		64	0	65	1	
DoorSqueak		64	0	66	1	
DoorSlam		64	0	67	1	
ScratchCut		64	0	68	1	
ScratchSplit		64	0	69	2	
WindChime		64	0	70	1	
TelphonRing2		64	0	71	1	
CarEngineIgn		64	0	81	1	
CarTiresSql		64	0	82	1	
CarPassing		64	0	83	1	
CarCrash		64	0	84	1	
Siren		64	0	85	2	
Train		64	0	86	1	
JetPlane		64	0	87	2	
Starship		64	0	88	2	
Burst		64	0	89	2	
RollrCoaster		64	0	90	2	
Submarine		64	0	91	1	
Laugh		64	0	97	1	
Scream	64	0	98	1		
Punch	64	0	99	1		
Heartbeat	64	0	100	1		
FootSteps	64	0	101	1		
MachineGun	64	0	113	1		
LaserGun	64	0	114	2		
Explosion	64	0	115	2		
Firework	64	0	116	2		

XG Drum Kit List

☐ : Same as Standard Kit 1

☐ : No Sound

Bank Select MSB (0-127)		127		127		127		127		127	
Bank Select LSB (0-127)		0		0		0		0		0	
Program Change (0-127)		0		1		8		16		24	
Program Change (1-128)		1		2		9		17		25	
MIDI		Key Off	Alternate Group	Standard Kit1	Standard Kit2	Room Kit	Rock Kit	Electro Kit	Analog Kit		
Note #	Note										
13	C#-1		3	Surdo Mute							
14	D-1		3	Surdo Open							
15	D#-1			Hi Q							
16	E-1			Whip Slap							
17	F-1		4	Scratch H							
18	F#-1		4	Scratch L							
19	G-1			Finger Snap							
20	G#-1			Click Noise							
21	A-1			Metronome Click							
22	A#-1			Metronome Bell							
23	B-1			Seq Click L							
24	C0			Seq Click H							
25	C#0			Brush Tap							
26	D0	○		Brush Swirl							
27	D#0			Brush Slap							
28	E0	○		Brush Tap Swirl				Reverse Cymbal		Reverse Cymbal	
29	F0	○		Snare Roll							
30	F#0			Castanet				Hi Q 2		Hi Q 2	
31	G0			Snare Soft	Snare Soft 2		Snare Noisy	Snare Snappy Electro		Snare Noisy 4	
32	G#0			Sticks							
33	A0			Kick Soft				Kick 3		Kick 3	
34	A#0			Open Rim Shot	Open Rim Shot H Short						
35	B0			Kick Tight			Kick 2	Kick Gate		Kick Analog Short	
36	C1			Kick	Kick Shot		Kick Gate	Kick Gate Heavy		Kick Analog	
37	C#1			Side Stick	Side Stick Light					Side Stick Analog	
38	D1			Snare	Snare Short	Snare Snappy	Snare Rock	Snare Noisy 2		Snare Analog	
39	D#1			Hand Clap							
40	E1			Snare Tight	Snare Tight H	Snare Tight Snappy	Snare Rock Tight	Snare Noisy 2		Snare Analog 2	
41	F1			Floor Tom L		Tom Room 1	Tom Room 1	Tom Electro 1		Tom Analog 1	
42	F#1		1	Hi-Hat Closed						Hi-Hat Closed Analog	
43	G1			Floor Tom H		Tom Room 2	Tom Room 2	Tom Electro 2		Tom Analog 2	
44	G#1		1	Hi-Hat Pedal						Hi-Hat Closed Analog 2	
45	A1			Low Tom		Tom Room 3	Tom Room 3	Tom Electro 3		Tom Analog 3	
46	A#1		1	Hi-Hat Open						Hi-Hat Open Analog	
47	B1			Mid Tom L		Tom Room 4	Tom Room 4	Tom Electro 4		Tom Analog 4	
48	C2			Mid Tom H		Tom Room 5	Tom Room 5	Tom Electro 5		Tom Analog 5	
49	C#2			Crash Cymbal 1						Crash Analog	
50	D2			High Tom		Tom Room 6	Tom Room 6	Tom Electro 6		Tom Analog 6	
51	D#2			Ride Cymbal 1							
52	E2			Chinese Cymbal							
53	F2			Ride Cymbal Cup							
54	F#2			Tambourine							
55	G2			Splash Cymbal							
56	G#2			Cowbell						Cowbell Analog	
57	A2			Crash Cymbal 2							
58	A#2			Vibraslap							
59	B2			Ride Cymbal 2							
60	C3			Bongo H							
61	C#3			Bongo L							
62	D3			Conga H Mute						Conga Analog H	
63	D#3			Conga H Open						Conga Analog M	
64	E3			Conga L						Conga Analog L	
65	F3			Timbale H							
66	F#3			Timbale L							
67	G3			Agogo H							
68	G#3			Agogo L							
69	A3			Cabasa							
70	A#3			Maracas						Maracas 2	
71	B3	○		Samba Whistle H							
72	C4	○		Samba Whistle L							
73	C#4			Guiro Short							
74	D4	○		Guiro Long							
75	D#4			Claves						Claves 2	
76	E4			Wood Block H							
77	F4			Wood Block L							
78	F#4			Cuica Mute				Scratch H 2		Scratch H 2	
79	G4			Cuica Open				Scratch L 2		Scratch L 2	
80	G#4		2	Triangle Mute							
81	A4		2	Triangle Open							
82	A#4			Shaker							
83	B4			Jingle Bells							
84	C5			Bell Tree							
85	C#5										
86	D5										
87	D#5										
88	E5										
89	F5										
90	F#5										
91	G5										

* Key Off: Keys marked with a circle stop sounding the instant they are released.

* Alternate Group: Playing any instrument within a numbered group will immediately stop the sound of any other instrument in the same group of the same number.

☐ : Same as Standard Kit 1

☐ : No Sound

MIDI				Dance Kit	Jazz Kit	Brush Kit	Symphony Kit	SFX Kit1	SFX Kit2
Note #	Note	Key Off	Alternate Group						
13	C#-1		3						
14	D-1		3						
15	D#-1								
16	E-1								
17	F-1		4						
18	F#-1		4						
19	G-1								
20	G#-1								
21	A-1								
22	A#-1								
23	B-1								
24	C0								
25	C#0								
26	D0	○							
27	D#0								
28	E0	○		Reverse Cymbal					
29	F0	○							
30	F#0			Hi Q 2					
31	G0			Snare Techno	Snare Jazz H	Brush Slap 2			
32	G#0								
33	A0			Kick Techno Q			Kick Soft 2		
34	A#0			Rim Gate		Open Rim Shot Light			
35	B0			Kick Techno L			Gran Cassa		
36	C1			Kick Techno	Kick Jazz	Kick Jazz	Gran Cassa Mute	Cutting Noise	Phone Call
37	C#1			Side Stick Analog	Side Stick Light	Side Stick Light		Cutting Noise 2	Door Squeak
38	D1			Snare Clap	Snare Jazz L	Brush Slap 3	Band Snare		Door Slam
39	D#1							String Slap	Scratch Cut
40	E1			Snare Dry	Snare Jazz M	Brush Tap 2	Band Snare 2		Scratch H 3
41	F1			Tom Analog 1		Tom Brush 1			Wind Chime
42	F#1		1	Hi-Hat Closed 3					Telephone Ring 2
43	G1			Tom Analog 2		Tom Brush 2			
44	G#1		1	Hi-Hat Closed Analog 3					
45	A1			Tom Analog 3		Tom Brush 3			
46	A#1		1	Hi-Hat Open 3					
47	B1			Tom Analog 4		Tom Brush 4			
48	C2			Tom Analog 5		Tom Brush 5			
49	C#2			Crash Analog			Hand Cymbal		
50	D2			Tom Analog 6		Tom Brush 6			
51	D#2						Hand Cymbal Short		
52	E2							Flute Key Click	Car Engine Ignition
53	F2								Car Tires Squeal
54	F#2								Car Passing
55	G2								Car Crash
56	G#2			Cowbell Analog					Siren
57	A2						Hand Cymbal 2		Train
58	A#2								Jet Plane
59	B2						Hand Cymbal 2 Short		Starship
60	C3								Burst
61	C#3								Roller Coaster
62	D3			Conga Analog H					Submarine
63	D#3			Conga Analog M					
64	E3			Conga Analog L					
65	F3								
66	F#3								
67	G3								
68	G#3								
69	A3							Shower	Laugh
70	A#3			Maracas 2				Thunder	Scream
71	B3	○						Wind	Punch
72	C4	○						Stream	Heart Beat
73	C#4							Bubble	Foot Steps
74	D4	○						Feed	
75	D#4			Claves 2					
76	E4								
77	F4								
78	F#4			Scratch H 2					
79	G4			Scratch L 2					
80	G#4		2						
81	A4		2						
82	A#4								
83	B4								
84	C5							Dog	Machine Gun
85	C#5							Horse	Laser Gun
86	D5							Bird Tweet 2	Explosion
87	D#5								Firework
88	E5								
89	F5								
90	F#5							Ghost	
91	G5							Maou	

* Key Off: Keys marked with a circle stop sounding the instant they are released.

* Alternate Group: Playing any instrument within a numbered group will immediately stop the sound of any other instrument in the same group of the same number.

MIDI Data Format

MIDI Channel Message (1)

MIDI Events	Status byte		1st Data byte		2nd Data byte		[MIDI (Silent)]							
	Status	Data (HEX)	Data (HEX)	Parameter	Data (HEX)	Parameter	MIDI Reception	MIDI Transmission						
							Song Part	Piano Playback Channel	Panel Operation	Song Playback	MIDI Input			
Key Off [GM1] [GM2]	8nH (n: Channel Number)	kk		Key Number (0-127)	vv	Velocity (0-127)	○	○	×	×	×			
Key On [GM1] [GM2]	9nH (n: Channel Number)	kk		Key Number (0-127)	vv	Key On: vv=1-127 Key Off: vv=0	○	○	×	×	×			
Control Change	BnH		0 (00H)	Bank Select MSB [GM2]	0 (00H) 64 (40H) 118 (76H) 119 (77H) 120 (78H) 121 (79H) 126 (7EH) 127 (7FH)	Normal SFX Voice GS Rhythm GS Normal GM2 Rhythm GM2 Normal SFX Kit Drum Kit	○	○	×	×	×			
			1 (01H)	Modulation [GM1] [GM2]	0-127 (00H...7FH)	Data	○	×	×	×	×	×		
			5 (05H)	Portamento Time [GM2]	0-127 (00H...7FH)	Data	○	×	×	×	×	×		
			6 (06H)	Data Entry MSB [GM2]	0-127 (00H...7FH)	Data	○	×	×	×	×	×		
			7 (07H)	Main Volume [GM1] [GM2]	0-127 (00H...7FH)	Data	○	○	×	×	×	×		
			10 (0AH)	Panpot [GM1] [GM2]	0-127 (00H...7FH)	L64...C...R63	○	×	×	×	×	×		
			11 (0BH)	Expression [GM1] [GM2]	0-127 (00H...7FH)	Data	○	×	×	×	×	×		
			32 (20H)	Bank Select LSB [GM2]	0-127 (00H...7FH)	Data	○	○	×	×	×	×		
			38 (26H)	Data Entry LSB [GM2]	0-127 (00H...7FH)	Data	○	×	×	×	×	×		
			64 (40H)	Damper [GM1] [GM2]	0-127 (00H...7FH)	Data	○	○	×	×	×	×		
			65 (41H)	Portamento [GM2]	0-127 (00H...7FH)	OFF: 0-63 ON: 64-127	○	×	×	×	×	×		
			66 (42H)	Sostenuto [GM2]	0-127 (00H...7FH)	OFF: 0-63 ON: 64-127	○	○	×	×	×	×		
			67 (43H)	Soft Pedal [GM2]	0-127 (00H...7FH)	OFF: 0-63 ON: 64-127	○	○	×	×	×	×		
			71 (47H)	Harmonic Content [GM2]	0-127 (00H...7FH)	-64...0...+63	○	×	×	×	×	×		
			72 (48H)	Release Time [GM2]	0-127 (00H...7FH)	-64...0...+63	○	×	×	×	×	×		
			73 (49H)	Attack Time [GM2]	0-127 (00H...7FH)	-64...0...+63	○	×	×	×	×	×		
			74 (4AH)	Brightness [GM2]	0-127 (00H...7FH)	-64...0...+63	○	×	×	×	×	×		
			75 (4BH)	Decay Time [GM2]	0-127 (00H...7FH)	-64...0...+63	○	×	×	×	×	×		
			76 (4CH)	Vibrate Rate [GM2]	0-127 (00H...7FH)	-64...0...+63	○	×	×	×	×	×		
			77 (4DH)	Vibrate Depth [GM2]	0-127 (00H...7FH)	-64...0...+63	○	×	×	×	×	×		
			78 (4EH)	Vibrate Delay [GM2]	0-127 (00H...7FH)	-64...0...+63	○	×	×	×	×	×		
			84 (54H)	Portamento Control [GM2]	0-127 (00H...7FH)	Key no. (0-127)	○	×	×	×	×	×		
			91 (5BH)	Effect1 Depth (Reverb Send Level) [GM2]	0-127 (00H...7FH)	Data	○	×	×	×	×	×		
			93 (5DH)	Effect3 Depth (Chorus Send Level) [GM2]	0-127 (00H...7FH)	Data	○	×	×	×	×	×		
			94 (5EH)	Effect4 Depth (Variation Send Level) [GM2]	0-127 (00H...7FH)	Data	○	×	×	×	×	×		
			96 (60H)	RPN Increment	—	—	The data byte is ignored	○	×	×	×	×	×	
			97 (61H)	RPN Decrement	—	—	The data byte is ignored	○	×	×	×	×	×	
			98 (62H)	NRPN LSB	0-127 (00H...7FH)	Data	○	×	×	×	×	×		
			99 (63H)	NRPN MSB	0-127 (00H...7FH)	Data	○	×	×	×	×	×		
			100 (64H)	RPN LSB [GM2]	0-127 (00H...7FH)	Data	○	×	×	×	×	×		
			101 (65H)	RPN MSB [GM2]	0-127 (00H...7FH)	Data	○	×	×	×	×	×		
			Mode Message	BnH (n: Channel Number)		120 (78H)	All Sound Off [GM2]	0 (00H)	Data	○	○	×	×	×
						121 (79H)	Reset All Controllers [GM1] [GM2]	0 (00H)	Data	○	○	×	×	×
						122 (7AH)	Local Control	0 (00h) 127 (7FH)	OFF ON	○	○	×	×	×
123 (7BH)	All Note Off [GM1] [GM2]	0 (00H)				Data	○	○	×	×	×			
124 (7CH)	Omni Off [GM2]	0 (00H)				Data	○	×	×	×	×			
125 (7DH)	Omni On [GM2]	0 (00H)				Data	○	×	×	×	×			
126 (7EH)	Mono [GM2]	0-16 (00H...10H)				Data	○	×	×	×	×			
127 (7FH)	Poly [GM2]	0 (00H)	Data	○	×	×	×	×						
Program Change [GM1] [GM2]	CnH (n: Channel Number)	pp (00H...7FH)	Voice Number (0-127)	—	—	—	○	○	×	×	×			
Channel After Touch [GM1] [GM2]	DnH (n: Channel Number)	vv (00H...7FH)	Data	—	—	—	○	×	×	×	×			
Polyphonic After Touch	AnH (n: Channel Number)	kk (00H...7FH)	Key Number (0-127)	vv (00H...7FH)	Data	○	○	×	×	×				
Pitch Bend Change [GM1] [GM2]	EnH (n: Channel Number)	cc (00H...7FH)	LSB	dd (00H...7FH)	MSB	○	×	×	×	×				
Realtime Message	F8H	MIDI Clock	—	—	—	—	×	×	×	×				
	FAH	Start	—	—	—	—	×	×	×	×				
	FBH	Continue	—	—	—	—	×	×	×	×				
	FCH	Stop	—	—	—	—	×	×	×	×				
	FEH	Active Sens [GM2]	—	—	—	—	○	×	×	○	×			
FFH	System Reset	—	—	—	—	×	×	×	×	×				

* For upright pianos (excluding some models), the sostenuto pedal information (Control Change 66) is not transmitted.

MIDI Channel Message (2)

Parameters Controlled by NRPN (Non-Registered Parameter Numbers)

NRPN		Data Entry		Parameter	Data Range	[MIDI (Silent)]				
MSB	LSB	MSB	LSB			MIDI Reception	MIDI Transmission			
						Song Part	Piano Playback Channel	Panel Operation	Song Playback	MIDI Input
01H	08H	mmH	---	Vibrato Rate	mm: 00H-40H-7FH (-64...0...+63)	○	×	×	×	×
01H	09H	mmH	---	Vibrato Depth	mm: 00H-40H-7FH (-64...0...+63)	○	×	×	×	×
01H	0AH	mmH	---	Vibrato Delay	mm: 00H-40H-7FH (-64...0...+63)	○	×	×	×	×
01H	20H	mmH	---	Low Pass Filter Cutoff Frequency	mm: 00H-40H-7FH (-64...0...+63)	○	×	×	×	×
01H	21H	mmH	---	Low Pass Filter Resonance	mm: 00H-40H-7FH (-64...0...+63)	○	×	×	×	×
01H	30H	mmH	---	EQ BASS	mm: 00H-40H-7FH (-64...0...+63)	×	×	×	×	×
01H	31H	mmH	---	EQ TREBLE	mm: 00H-40H-7FH (-64...0...+63)	×	×	×	×	×
01H	34H	mmH	---	EQ BASS Frequency	mm: 04H-28H (32...2.0k [Hz])	×	×	×	×	×
01H	35H	mmH	---	EQ TREBLE Frequency	mm: 1CH-3AH (500...16.0k [Hz])	×	×	×	×	×
01H	63H	mmH	---	EG Attack Time	mm: 00H-40H-7FH (-64...0...+63)	○	×	×	×	×
01H	64H	mmH	---	EG Decay Time	mm: 00H-40H-7FH (-64...0...+63)	○	×	×	×	×
01H	66H	mmH	---	EG Release	mm: 00H-40H-7FH (-64...0...+63)	○	×	×	×	×
14H	rrH	mmH	---	Drum Low Pass Filter Cutoff Frequency	rr: drum instrument note number mm: 00H-40H-7FH (-64...0...+63)	○	×	×	×	×
15H	rrH	mmH	---	Drum Low Pass Filter Resonance	rr: drum instrument note number mm: 00H-40H-7FH (-64...0...+63)	○	×	×	×	×
16H	rrH	mmH	---	Drum EG Attack Rate	rr: drum instrument note number mm: 00H-40H-7FH (-64...0...+63)	○	×	×	×	×
17H	rrH	mmH	---	Drum EG Decay Rate	rr: drum instrument note number mm: 00H-40H-7FH (-64...0...+63)	○	×	×	×	×
18H	rrH	mmH	---	Drum Pitch Coarse	rr: drum instrument note number mm: 00H-40H-7FH (-64...0...+63)	○	×	×	×	×
19H	rrH	mmH	---	Drum Pitch Fine	rr: drum instrument note number mm: 00H-40H-7FH (-64...0...+63)	○	×	×	×	×
1AH	rrH	mmH	---	Drum Level	rr: drum instrument note number mm: 00H-7FH (0...127)	○	×	×	×	×
1CH	rrH	mmH	---	Drum Pan	rr: drum instrument note number mm: 00H, 01H-40H-7FH (RND, L63...C...R63)	○	×	×	×	×
1DH	rrH	mmH	---	Drum Reverb Send Level	rr: drum instrument note number mm: 00H-7FH (0...127)	○	×	×	×	×
1EH	rrH	mmH	---	Drum Chorus Send Level	rr: drum instrument note number mm: 00H-7FH (0...127)	○	×	×	×	×
1FH	rrH	mmH	---	Drum Variation Send Level	rr: drum instrument note number mm: 00H-7FH (0...127) (Variation Connection = SYSTEM) mm: 00H, 01H-7FH (OFF, ON) (Variation Connection = INSERTION)	○	×	×	×	×
24H	rrH	mmH	---	Drum HPF Cutoff Frequency	rr: drum instrument note number mm: 00H-40H-7FH (-64...0...+63)	×	×	×	×	×
30H	rrH	mmH	---	Drum EQ Bass Gain	rr: drum instrument note number mm: 00H-7FH (0...127)	×	×	×	×	×
31H	rrH	mmH	---	Drum EQ Treble Gain	rr: drum instrument note number mm: 00H-7FH (0...127)	×	×	×	×	×
34H	rrH	mmH	---	Drum EQ Bass Frequency	rr: drum instrument note number mm: 04H-28H (32...2.0k [Hz])	×	×	×	×	×
35H	rrH	mmH	---	Drum EQ Treble Frequency	rr: drum instrument note number mm: 1CH-3AH (500...16.0k [Hz])	×	×	×	×	×
40H	rrH	mmH	---	Drum VELOCITY PITCH SENS.	rr: drum instrument note number mm: 00H-0FH (0...15)	×	×	×	×	×
41H	rrH	mmH	---	Drum VELOCITY LPF CUTOFF SENS.	rr: drum instrument note number mm: 00H-0FH (0...15)	×	×	×	×	×

* NRPN MSB: 14H-1FH (for drums) message is accepted as long as the channel is set with a drum voice.
 * Data Entry LSB will be ignored.

Parameters Controlled by RPN (Registered Parameter Numbers)

RPN		Data Entry		Parameter	Data Range	[MIDI (Silent)]				
MSB	LSB	MSB	LSB			MIDI Reception	MIDI Transmission			
						Song Part	Piano Playback Channel	Panel Operation	Song Playback	MIDI Input
00H	00H	mmH	---	Pitch Bend Sensitivity [GM1] [GM2]	mm: 00H-18H (0...+24 [semitones])	○	×	×	×	×
00H	01H	mmH	llH	Fine Tune [GM1] [GM2]	mm ll: 00H 00H -100 [cent] ... mm ll: 40H 00H 0 [cent] ... mm ll: 7FH 7FH 100 [cent]	○	×	×	×	×
00H	02H	mmH	---	Coarse Tune [GM1] [GM2]	mm: 28H-40H-58H (-24...0...+24 [semitones])	○	×	×	×	×
00H	05H	mmH	llH	Modulation Sensitivity [GM2]	mm: Specified in semitone increments ll: Specified in 100/128 cent increments	○	×	×	×	×
7FH	7FH	---	---	Null [GM2]	---	○	×	×	×	×

MIDI Parameter Change Table

■ MIDI Parameter Change Table (XG SYSTEM)

Address (H)	Size (H)	Data (H)	Parameter	Description	XG Default (H)	[MIDI (Silent)]				
						MIDI Reception		MIDI Transmission		
						Song Part	Piano Playback Channel	Panel Operation	Song Playback	MIDI Input
00	00	00	4	00-0F 00-0F 00-0F 00-0F	MASTER TUNE	-102.4...0...+102.3 [cent]				
	04	1	00-7F	00-7F	MASTER VOLUME	0...127	○	×	×	×
	05	1	00-7F	00-7F	MASTER ATTENUATOR	0...127	×	×	×	×
	06	1	28-58	28-58	TRANSPOSE	-24...0...+24 [semitones]	○	×	×	×
	7D	1	N	N	DRUM SETUP RESET	N: Drum setup number	○	×	×	×
	7E	1	00	00	XG SYSTEM ON	00=XG system ON	○	×	×	×
	7F	1	00	00	ALL PARAMETER RESET	00=ON	○	×	×	×
TOTAL SIZE										

■ MIDI Parameter Change Table (SYSTEM INFORMATION)

Address (H)	Size (H)	Data (H)	Parameter	Description	[MIDI (Silent)]					
					MIDI Reception		MIDI Transmission			
					Song Part	Piano Playback Channel	Panel Operation	Song Playback	MIDI Input	
01	00	00	E	20-7F	Model Name 1	32...127 (ASCII CHARACTER)				
		Model Name 14	32...127 (ASCII CHARACTER)				
		0D								
	0E	1			NOT USED					
	0F	1			NOT USED					
TOTAL SIZE										

* Transmitted in response to dump request. Not received.

■ MIDI Parameter Change Table (EFFECT1)

Address (H)	Size (H)	Data (H)	Parameter	Description	XG Default (H)	[MIDI (Silent)]				
						MIDI Reception		MIDI Transmission		
						Song Part	Piano Playback Channel	Panel Operation	Song Playback	MIDI Input
02	01	00	2	00-7F 00-7F	REVERB TYPE MSB REVERB TYPE LSB	Refer to Effect Parameter List				
	02	1	00-7F	00-7F	REVERB PARAMETER 1	Refer to Effect Parameter List	○	×	×	×
	03	1	00-7F	00-7F	REVERB PARAMETER 2	Refer to Effect Parameter List	○	×	×	×
	04	1	00-7F	00-7F	REVERB PARAMETER 3	Refer to Effect Parameter List	○	×	×	×
	05	1	00-7F	00-7F	REVERB PARAMETER 4	Refer to Effect Parameter List	○	×	×	×
	06	1	00-7F	00-7F	REVERB PARAMETER 5	Refer to Effect Parameter List	○	×	×	×
	07	1	00-7F	00-7F	REVERB PARAMETER 6	Refer to Effect Parameter List	○	×	×	×
	08	1	00-7F	00-7F	REVERB PARAMETER 7	Refer to Effect Parameter List	○	×	×	×
	09	1	00-7F	00-7F	REVERB PARAMETER 8	Refer to Effect Parameter List	○	×	×	×
	0A	1	00-7F	00-7F	REVERB PARAMETER 9	Refer to Effect Parameter List	○	×	×	×
	0B	1	00-7F	00-7F	REVERB PARAMETER 10	Refer to Effect Parameter List	○	×	×	×
	0C	1	00-7F	00-7F	REVERB RETURN	~$-$0dB...0dB...+6dB (0...64...127)	○	×	×	×
	0D	1	01-7F	01-7F	REVERB PAN	L63...C...R63	○	×	×	×
TOTAL SIZE										
02	01	10	1	00-7F	REVERB PARAMETER 11	Refer to Effect Parameter List	○	×	×	×
TOTAL SIZE										

Address (H)		Size (H)	Data (H)	Parameter	Description	XG Default (H)	[MIDI (Silent)]					
							MIDI Reception		MIDI Transmission			
							Song Part	Piano Playback Channel	Panel Operation	Song Playback	MIDI Input	
02	01	20	2	00-7F 00-7F	CHORUS TYPE MSB CHORUS TYPE LSB	Refer to Effect Parameter List	41(=CHORUS1)	00				
		22	1	00-7F	CHORUS PARAMETER 1	Refer to Effect Parameter List	Depends on Chorus Type		×	×	×	×
		23	1	00-7F	CHORUS PARAMETER 2	Refer to Effect Parameter List	Depends on Chorus Type		×	×	×	×
		24	1	00-7F	CHORUS PARAMETER 3	Refer to Effect Parameter List	Depends on Chorus Type		×	×	×	×
		25	1	00-7F	CHORUS PARAMETER 4	Refer to Effect Parameter List	Depends on Chorus Type		×	×	×	×
		26	1	00-7F	CHORUS PARAMETER 5	Refer to Effect Parameter List	Depends on Chorus Type		×	×	×	×
		27	1	00-7F	CHORUS PARAMETER 6	Refer to Effect Parameter List	Depends on Chorus Type		×	×	×	×
		28	1	00-7F	CHORUS PARAMETER 7	Refer to Effect Parameter List	Depends on Chorus Type		×	×	×	×
		29	1	00-7F	CHORUS PARAMETER 8	Refer to Effect Parameter List	Depends on Chorus Type		×	×	×	×
		2A	1	00-7F	CHORUS PARAMETER 9	Refer to Effect Parameter List	Depends on Chorus Type		×	×	×	×
		2B	1	00-7F	CHORUS PARAMETER 10	Refer to Effect Parameter List	Depends on Chorus Type		×	×	×	×
		2C	1	00-7F	CHORUS RETURN	-<rdB...<rdB...+6dB (0...64...127)	40		×	×	×	×
		2D	1	01-7F	CHORUS PAN	L63...C...R63	40		×	×	×	×
		2E	1	00-7F	SEND CHORUS TO REVERB	-<rdB...<rdB...+6dB (0...64...127)	00		×	×	×	×
TOTAL SIZE		0F										

		30	1	00-7F	CHORUS PARAMETER 11	Refer to Effect Parameter List	Depends on Chorus Type		×	×	×	×
		31	1	00-7F	CHORUS PARAMETER 12	Refer to Effect Parameter List	Depends on Chorus Type		×	×	×	×
		32	1	00-7F	CHORUS PARAMETER 13	Refer to Effect Parameter List	Depends on Chorus Type		×	×	×	×
		33	1	00-7F	CHORUS PARAMETER 14	Refer to Effect Parameter List	Depends on Chorus Type		×	×	×	×
		34	1	00-7F	CHORUS PARAMETER 15	Refer to Effect Parameter List	Depends on Chorus Type		×	×	×	×
		35	1	00-7F	CHORUS PARAMETER 16	Refer to Effect Parameter List	Depends on Chorus Type		×	×	×	×
TOTAL SIZE		06										

Address (H)		Size (H)	Data (H)	Parameter	Description	XG Default (H)	[MIDI (Silent)]					
							MIDI Reception		MIDI Transmission			
							Song Part	Piano Playback Channel	Panel Operation	Song Playback	MIDI Input	
02	01	40	2	00-7F 00-7F	VARIATION TYPE MSB VARIATION TYPE LSB	Refer to Effect Parameter List	05 (=DELAY L, C, R)	00				
		42	2	00-7F 00-7F	VARIATION PARAMETER 1 MSB VARIATION PARAMETER 1 LSB	Refer to Effect Parameter List	Depends on Variation Type		×	×	×	×
		44	2	00-7F 00-7F	VARIATION PARAMETER 2 MSB VARIATION PARAMETER 2 LSB	Refer to Effect Parameter List	Depends on Variation Type		×	×	×	×
		46	2	00-7F 00-7F	VARIATION PARAMETER 3 MSB VARIATION PARAMETER 3 LSB	Refer to Effect Parameter List	Depends on Variation Type		×	×	×	×
		48	2	00-7F 00-7F	VARIATION PARAMETER 4 MSB VARIATION PARAMETER 4 LSB	Refer to Effect Parameter List	Depends on Variation Type		×	×	×	×
		4A	2	00-7F 00-7F	VARIATION PARAMETER 5 MSB VARIATION PARAMETER 5 LSB	Refer to Effect Parameter List	Depends on Variation Type		×	×	×	×
		4C	2	00-7F 00-7F	VARIATION PARAMETER 6 MSB VARIATION PARAMETER 6 LSB	Refer to Effect Parameter List	Depends on Variation Type		×	×	×	×
		4E	2	00-7F 00-7F	VARIATION PARAMETER 7 MSB VARIATION PARAMETER 7 LSB	Refer to Effect Parameter List	Depends on Variation Type		×	×	×	×
		50	2	00-7F 00-7F	VARIATION PARAMETER 8 MSB VARIATION PARAMETER 8 LSB	Refer to Effect Parameter List	Depends on Variation Type		×	×	×	×
		52	2	00-7F 00-7F	VARIATION PARAMETER 9 MSB VARIATION PARAMETER 9 LSB	Refer to Effect Parameter List	Depends on Variation Type		×	×	×	×
		54	2	00-7F 00-7F	VARIATION PARAMETER 10 MSB VARIATION PARAMETER 10 LSB	Refer to Effect Parameter List	Depends on Variation Type		×	×	×	×
		56	1	00-7F	VARIATION RETURN	-<rdB...<rdB...+6dB (0...64...127)	40		×	×	×	×
		57	1	01-7F	VARIATION PAN	L63...C...R63	40		×	×	×	×
		58	1	00-7F	SEND VARIATION TO REVERB	-<rdB...<rdB...+6dB (0...64...127)	00		×	×	×	×
		59	1	00-7F	SEND VARIATION TO CHORUS	-<rdB...<rdB...+6dB (0...64...127)	00		×	×	×	×
		5A	1	00-01	VARIATION CONNECTION	INSERTION, SYSTEM	00		×	×	×	×
		5B	1	00-7F	VARIATION PART NUMBER	Reception: Part1...16 (0...15) Transmission: Part1...16 (0...15) AD (64) OFF (127)	7F		×	×	×	×
		5C	1	00-7F	MW VARIATION CONTROL DEPTH	-64...0...+63	40		×	×	×	×
		5D	1	00-7F	BEND VARIATION CONTROL DEPTH	-64...0...+63	40		×	×	×	×
		5E	1	00-7F	CAT VARIATION CONTROL DEPTH	-64...0...+63	40		×	×	×	×
		5F	1	00-7F	AC1 VARIATION CONTROL DEPTH	-64...0...+63	40		×	×	×	×
		60	1	00-7F	AC2 VARIATION CONTROL DEPTH	-64...0...+63	40		×	×	×	×
TOTAL SIZE		21										

		70	1	00-7F	VARIATION PARAMETER 11	Refer to Effect Parameter List	Depends on Variation Type		×	×	×	×
		71	1	00-7F	VARIATION PARAMETER 12	Refer to Effect Parameter List	Depends on Variation Type		×	×	×	×
		72	1	00-7F	VARIATION PARAMETER 13	Refer to Effect Parameter List	Depends on Variation Type		×	×	×	×
		73	1	00-7F	VARIATION PARAMETER 14	Refer to Effect Parameter List	Depends on Variation Type		×	×	×	×
		74	1	00-7F	VARIATION PARAMETER 15	Refer to Effect Parameter List	Depends on Variation Type		×	×	×	×
		75	1	00-7F	VARIATION PARAMETER 16	Refer to Effect Parameter List	Depends on Variation Type		×	×	×	×
TOTAL SIZE		06										

MIDI Parameter Change Table (MULTI PART)

Address (H)	Size (H)	Data (H)	Parameter	Description	XG Default (H)	[MIDI (Silent)]							
						MIDI Reception	MIDI Transmission		MIDI Input				
Song Part	Piano Playback Channel	Panel Operation	Song Playback	MIDI Input									
08	nn	00	1	00-20	NOT USED		x	x	x	x	x		
		01	1	00-7F	BANK SELECT MSB	0...127	part10=7F, other parts=00	○	○	x	x	x	x
		02	1	00-7F	BANK SELECT LSB	0...127	00	○	○	x	x	x	x
		03	1	00-7F	PROGRAM NUMBER	1...128	00	○	○	x	x	x	x
		04	1	00-0F, 7F	Rcv CHANNEL	1...16, OFF	Part No.	○	x	x	x	x	x
		05	1	00-01	MONO/POLY MODE	MONO, POLY	01	○	x	x	x	x	x
		06	1	00-02	SAME NOTE NUMBER KEY ON ASSIGN	SINGLE, MULTI, INST (for Drum)	01	○	x	x	x	x	x
		07	1	00-03	PART MODE	NORMAL, DRUM, DRUMS1...2	part10=02, other parts=00	○	x	x	x	x	x
		08	1	28-58	NOTE SHIFT	-24...0...+24 [semitones]	40	○	x	x	x	x	x
		09	2	00-0F 00-0F	DETUNE	-12.8...0...+12.7 [Hz] 1st bit3-0→bit7-4 2nd bit3-0→bit3-0	08 00	○	x	x	x	x	x
		0B	1	00-7F	VOLUME	0...127	64	○	x	x	x	x	x
		0C	1	00-7F	VELOCITY SENSE DEPTH	0...127	40	○	x	x	x	x	x
		0D	1	00-7F	VELOCITY SENSE OFFSET	0...127	40	○	x	x	x	x	x
		0E	1	00-7F	PAN	RND, L63...C...R63	40	○	x	x	x	x	x
		0F	1	00-7F	NOTE LIMIT LOW	C-2...G8	00	○	x	x	x	x	x
		10	1	00-7F	NOTE LIMIT HIGH	C-2...G8	7F	○	x	x	x	x	x
		11	1	00-7F	DRY LEVEL	0...127	7F	○	x	x	x	x	x
		12	1	00-7F	CHORUS SEND	0...127	00	○	x	x	x	x	x
		13	1	00-7F	REVERB SEND	0...127	28	○	x	x	x	x	x
		14	1	00-7F	VARIATION SEND	0...127	00	○	x	x	x	x	x
		15	1	00-7F	VIBRATO RATE	-64...0...+63	40	○	x	x	x	x	x
		16	1	00-7F	VIBRATO DEPTH	-64...0...+63	40	○	x	x	x	x	x
		17	1	00-7F	VIBRATO DELAY	-64...0...+63	40	○	x	x	x	x	x
		18	1	00-7F	FILTER CUTOFF FREQUENCY	-64...0...+63	40	○	x	x	x	x	x
		19	1	00-7F	FILTER RESONANCE	-64...0...+63	40	○	x	x	x	x	x
		1A	1	00-7F	EG ATTACK TIME	-64...0...+63	40	○	x	x	x	x	x
		1B	1	00-7F	EG DECAY TIME	-64...0...+63	40	○	x	x	x	x	x
		1C	1	00-7F	EG RELEASE TIME	-64...0...+63	40	○	x	x	x	x	x
		1D	1	28-58	H	-24...0...+24 [semitones]	40	○	x	x	x	x	x
		1E	1	00-7F	MW LOW PASS FILTER CONTROL	-9600...0...+9450 [cent]	40	○	x	x	x	x	x
		1F	1	00-7F	MW AMPLITUDE CONTROL	-100...0...+100 [%]	40	○	x	x	x	x	x
		20	1	00-7F	MW LFO PMOD DEPTH	0...127	0A	○	x	x	x	x	x
		21	1	00-7F	MW LFO FMOD DEPTH	0...127	00	○	x	x	x	x	x
		22	1	00-7F	MW LFO AMOD DEPTH	0...127	00	○	x	x	x	x	x
		23	1	28-58	BEND PITCH CONTROL	-24...0...+24 [semitones]	42	○	x	x	x	x	x
		24	1	00-7F	BEND LOW PASS FILTER CONTROL	-9600...0...+9450 [cent]	40	○	x	x	x	x	x
		25	1	00-7F	BEND AMPLITUDE CONTROL	-100...0...+100 [%]	40	○	x	x	x	x	x
		26	1	00-7F	BEND LFO PMOD DEPTH	0...127	00	○	x	x	x	x	x
		27	1	00-7F	BEND LFO FMOD DEPTH	0...127	00	○	x	x	x	x	x
		28	1	00-7F	BEND LFO AMOD DEPTH	0...127	00	○	x	x	x	x	x
TOTAL SIZE						29							
		30	1	00-01	Rcv PITCH BEND	OFF, ON	01	○	x	x	x	x	x
		31	1	00-01	Rcv CH AFTER TOUCH (CAT)	OFF, ON	01	○	x	x	x	x	x
		32	1	00-01	Rcv PROGRAM CHANGE	OFF, ON	01	○	x	x	x	x	x
		33	1	00-01	Rcv CONTROL CHANGE	OFF, ON	01	○	x	x	x	x	x
		34	1	00-01	Rcv POLY AFTER TOUCH (PAT)	OFF, ON	01	○	x	x	x	x	x
		35	1	00-01	Rcv NOTE MESSAGE	OFF, ON	01	○	x	x	x	x	x
		36	1	00-01	Rcv RPN	OFF, ON	01	○	x	x	x	x	x
		37	1	00-01	Rcv NRPN	OFF, ON	XGmode=01, GMmode=00	○	x	x	x	x	x
		38	1	00-01	Rcv MODULATION	OFF, ON	01	○	x	x	x	x	x
		39	1	00-01	Rcv VOLUME	OFF, ON	01	○	x	x	x	x	x
		3A	1	00-01	Rcv PAN	OFF, ON	01	○	x	x	x	x	x
		3B	1	00-01	Rcv EXPRESSION	OFF, ON	01	○	x	x	x	x	x
		3C	1	00-01	Rcv HOLD1	OFF, ON	01	○	x	x	x	x	x
		3D	1	00-01	Rcv PORTAMENTO	OFF, ON	01	○	x	x	x	x	x
		3E	1	00-01	Rcv SOSTENUTO	OFF, ON	01	○	x	x	x	x	x
		3F	1	00-01	Rcv SOFT PEDAL	OFF, ON	01	○	x	x	x	x	x
		40	1	00-01	Rcv BANK SELECT	OFF, ON	01	○	x	x	x	x	x
		41	1	00-7F	SCALE TUNING C	-63...0...+63 [cent]	40	○	x	x	x	x	x
		42	1	00-7F	SCALE TUNING C#	-63...0...+63 [cent]	40	○	x	x	x	x	x
		43	1	00-7F	SCALE TUNING D	-63...0...+63 [cent]	40	○	x	x	x	x	x
		44	1	00-7F	SCALE TUNING D#	-63...0...+63 [cent]	40	○	x	x	x	x	x
		45	1	00-7F	SCALE TUNING E	-63...0...+63 [cent]	40	○	x	x	x	x	x
		46	1	00-7F	SCALE TUNING F	-63...0...+63 [cent]	40	○	x	x	x	x	x
		47	1	00-7F	SCALE TUNING F#	-63...0...+63 [cent]	40	○	x	x	x	x	x
		48	1	00-7F	SCALE TUNING G	-63...0...+63 [cent]	40	○	x	x	x	x	x
		49	1	00-7F	SCALE TUNING G#	-63...0...+63 [cent]	40	○	x	x	x	x	x
		4A	1	00-7F	SCALE TUNING A	-63...0...+63 [cent]	40	○	x	x	x	x	x
		4B	1	00-7F	SCALE TUNING A#	-63...0...+63 [cent]	40	○	x	x	x	x	x
		4C	1	00-7F	SCALE TUNING B	-63...0...+63 [cent]	40	○	x	x	x	x	x
		4D	1	28-58	CAT PITCH CONTROL	-24...0...+24 [semitones]	40	○	x	x	x	x	x
		4E	1	00-7F	CAT LOW PASS FILTER CONTROL	-9600...0...+9450 [cent]	40	○	x	x	x	x	x
		4F	1	00-7F	CAT AMPLITUDE CONTROL	-100...0...+100 [%]	40	○	x	x	x	x	x
		50	1	00-7F	CAT LFO PMOD DEPTH	0...127	00	○	x	x	x	x	x
		51	1	00-7F	CAT LFO FMOD DEPTH	0...127	00	○	x	x	x	x	x
		52	1	00-7F	CAT LFO AMOD DEPTH	0...127	00	○	x	x	x	x	x

MIDI Data Format

[MIDI (Silent)]

Address (H)	Size (H)	Data (H)	Parameter	Description	XG Default (H)	MIDI Reception		MIDI Transmission			
						Song Part	Piano Playback Channel	Panel Operation	Song Playback	MIDI Input	
	53	1	28-58	PAT PITCH CONTROL	-24...0...+24 [semitones]	40	○	×	×	×	×
	54	1	00-7F	PAT LOW PASS FILTER CONTROL	-9600...0...+9450 [cent]	40	○	×	×	×	×
	55	1	00-7F	PAT AMPLITUDE CONTROL	-100...0...+100 [%]	40	○	×	×	×	×
	56	1	00-7F	PAT LFO PMOD DEPTH	0...127	00	○	×	×	×	×
	57	1	00-7F	PAT LFO FMOD DEPTH	0...127	00	○	×	×	×	×
	58	1	00-7F	PAT LFO AMOD DEPTH	0...127	00	○	×	×	×	×
	59	1	00-5F	AC1 CONTROLLER NUMBER	0...95	10	○	×	×	×	×
	5A	1	28-58	AC1 PITCH CONTROL	-24...0...+24 [semitones]	40	○	×	×	×	×
	5B	1	00-7F	AC1 LOW PASS FILTER CONTROL	-9600...0...+9450 [cent]	40	○	×	×	×	×
	5C	1	00-7F	AC1 AMPLITUDE CONTROL	-100...0...+100 [%]	40	○	×	×	×	×
	5D	1	00-7F	AC1 LFO PMOD DEPTH	0...127	00	○	×	×	×	×
	5E	1	00-7F	AC1 LFO FMOD DEPTH	0...127	00	○	×	×	×	×
	5F	1	00-7F	AC1 LFO AMOD DEPTH	0...127	00	○	×	×	×	×
	60	1	00-5F	AC2 CONTROLLER NUMBER	0...95	11	○	×	×	×	×
	61	1	28-58	AC2 PITCH CONTROL	-24...0...+24 [semitones]	40	○	×	×	×	×
	62	1	00-7F	AC2 LOW PASS FILTER CONTROL	-9600...0...+9450 [cent]	40	○	×	×	×	×
	63	1	00-7F	AC2 AMPLITUDE CONTROL	-100...0...+100 [%]	40	○	×	×	×	×
	64	1	00-7F	AC2 LFO PMOD DEPTH	0...127	00	○	×	×	×	×
	65	1	00-7F	AC2 LFO FMOD DEPTH	0...127	00	○	×	×	×	×
	66	1	00-7F	AC2 LFO AMOD DEPTH	0...127	00	○	×	×	×	×
	67	1	00-01	PORTAMENTO SWITCH	OFF, ON	00	○	×	×	×	×
	68	1	00-7F	PORTAMENTO TIME	0...127	00	○	×	×	×	×
	69	1	00-7F	PITCH EG INITIAL LEVEL	-64...0...+63	40	○	×	×	×	×
	6A	1	00-7F	PITCH EG ATTACK TIME	-64...0...+63	40	○	×	×	×	×
	6B	1	00-7F	PITCH EG RELEASE LEVEL	-64...0...+63	40	○	×	×	×	×
	6C	1	00-7F	PITCH EG RELEASE TIME	-64...0...+63	40	○	×	×	×	×
	6D	1	01-7F	VELOCITY LIMIT LOW	1...127	01	○	×	×	×	×
	6E	1	01-7F	VELOCITY LIMIT HIGH	1...127	7F	○	×	×	×	×
TOTAL SIZE		3F									

	70	1		NOT USED		---	---	---	---	---	
	71	1		NOT USED		---	---	---	---	---	
	72	1	00-7F	EQ BASS GAIN	-12dB...+12dB	40	×	×	×	×	×
	73	1	00-7F	EQ TREBLE GAIN	-12dB...+12dB	40	×	×	×	×	×
TOTAL SIZE		04									

	74	1		NOT USED		---	---	---	---	---	
	75	1		NOT USED		---	---	---	---	---	
	76	1	04-28	EQ BASS FREQUENCY	32...2.0k [Hz]	0C	×	×	×	×	×
	77	1	1C-3A	EQ TREBLE FREQUENCY	500...16.0k [Hz]	36	×	×	×	×	×
	78	1		NOT USED		---	---	---	---	---	
	79	1		NOT USED		---	---	---	---	---	
	7A	1		NOT USED		---	---	---	---	---	
	7B	1		NOT USED		---	---	---	---	---	
	7C	1		NOT USED		---	---	---	---	---	
	7D	1		NOT USED		---	---	---	---	---	
	7E	1		NOT USED		---	---	---	---	---	
	7F	1		NOT USED		---	---	---	---	---	
TOTAL SIZE		0C									

0A	nn	40	1	00-7F	MW OFFSET LEVEL CONTROL	-100 - 100 [%]	40	○	×	×	×	×
		41	1	00-7F	BEND OFFSET LEVEL CONTROL	-100 - 100 [%]	40	○	×	×	×	×
		42	1	00-7F	CAT OFFSET LEVEL CONTROL	-100 - 100 [%]	40	○	×	×	×	×
		43	1	00-7F	PAT OFFSET LEVEL CONTROL	-100 - 100 [%]	40	○	×	×	×	×
		44	1	00-7F	AC1 OFFSET LEVEL CONTROL	-100 - 100 [%]	40	○	×	×	×	×
		45	1	00-7F	AC2 OFFSET LEVEL CONTROL	-100 - 100 [%]	40	○	×	×	×	×
TOTAL SIZE		06										

nn: part number

If there is a Drum voice assigned to the part, the following parameters are ineffective.

- BANK SELECT LSB
- PORTAMENTO
- MONO/POLY
- SCALE TUNING
- POLY AFTER TOUCH
- PITCH EG

■ MIDI Parameter Change Table (DRUM SETUP)

							[MIDI (Silent)]				
Address (H)		Size (H)	Data (H)	Parameter	Description	XG Default (H)	MIDI Reception		MIDI Transmission		
							Song Part	Piano Playback Channel	Panel Operation	Song Playback	MIDI Input
3n	rr	00	1	00-7F	PITCH COARSE	-64...0...+63	○	×	×	×	×
		01	1	00-7F	PITCH FINE	-64...0...+63 [cent]	○	×	×	×	×
		02	1	00-7F	LEVEL	0...127	○	×	×	×	×
		03	1	00-7F	ALTERNATE GROUP	OFF, 1...127	○	×	×	×	×
		04	1	00-7F	PAN	RND, L63...C...R63	○	×	×	×	×
		05	1	00-7F	REVERB SEND	0...127	○	×	×	×	×
		06	1	00-7F	CHORUS SEND	0...127	○	×	×	×	×
		07	1	00-7F	VARIATION SEND	0...127	○	×	×	×	×
		08	1	00-01	KEY ASSIGN	SINGLE, MULTI	○	×	×	×	×
		09	1	00-01	Rcv NOTE OFF	OFF, ON	○	×	×	×	×
		0A	1	00-01	Rcv NOTE ON	OFF, ON	○	×	×	×	×
		0B	1	00-7F	LOW PASS FILTER CUTOFF FREQUENCY	-64...0...+63	○	×	×	×	×
		0C	1	00-7F	LOW PASS FILTER RESONANCE	-64...0...+63	○	×	×	×	×
		0D	1	00-7F	EG ATTACK RATE	-64...0...+63	○	×	×	×	×
		0E	1	00-7F	EG DECAY1 RATE	-64...0...+63	○	×	×	×	×
		0F	1	00-7F	EG DECAY2 RATE	-64...0...+63	○	×	×	×	×
TOTAL SIZE		10									
		20	1	00-7F	EQ BASS GAIN	-12...+12 [dB]	×	×	×	×	×
		21	1	00-7F	EQ TREBLE GAIN	-12...+12 [dB]	×	×	×	×	×
		22	1		NOT USED	---	---	---	---	---	---
		23	1		NOT USED	---	---	---	---	---	---
		24	1	04-28	EQ BASS FREQUENCY	32...2.0k [Hz]	×	×	×	×	×
		25	1	1C-3A	EQ TREBLE FREQUENCY	500...16.0k [Hz]	×	×	×	×	×
		26	1		NOT USED	---	---	---	---	---	---
		27	1		NOT USED	---	---	---	---	---	---
		28	1		NOT USED	---	---	---	---	---	---
		29	1		NOT USED	---	---	---	---	---	---
		2A	1		NOT USED	---	---	---	---	---	---
		2B	1		NOT USED	---	---	---	---	---	---
		2C	1		NOT USED	---	---	---	---	---	---
		2D	1		NOT USED	---	---	---	---	---	---
TOTAL SIZE		0E									

n: drum setup number (0-1)
 rr: note number (0D-5B)

In the following cases, the unit will initialize all drum setups.

- XG SYSTEM ON received
- GM SYSTEM ON received
- GM LEVEL 2 SYSTEM ON received
- GS RESET received
- DRUM SETUP RESET received (only when in XG mode)

When a part to which a drum setup is assigned receives a program change, the assigned drum setup will be initialized.

If the same drum setup is assigned to two or more parts, changes in drum setup parameters (including program changes) will apply to all parts to which it is assigned.

System Exclusive Messages (1)

* Not received when Receive System Exclusive Message is set to off.
 * Not transmitted when Transmit System Exclusive Message is set to off.

■ System Exclusive Messages (Universal Non Realtime Messages)

MIDI Event	Data Format	[MIDI (Silent)]				
		MIDI Reception		MIDI Transmission		
		Song Part	Piano Playback Channel	Panel Operation	Song Playback	MIDI Input
GMI System On [GM1] [GM2]	F0 7E XN 09 01 F7 11110000 F0 = Exclusive status 01111110 7E = Universal Non-Real Time 0xxxxnnn XN = When N is received N=0-F, whichever is received. X=ignored 00001001 09 = Sub-ID #1=General MIDI Message 00000001 01 = Sub-ID #2=General MIDI On 11110111 F7 = End of Exclusive	○	×	×	×	×

System Exclusive Messages (2)

■ System Exclusive Messages (XG)

MIDI Event	Data Format	[MIDI (Silent)]			
		MIDI Reception		MIDI Transmission	
		Song Part	Piano Playback Channel	Panel Operation	Song Playback
XG Parameter Change	F0 43 1n 4C hh mm ll dd ... F7 11110000 F0 = Exclusive status 01000011 43 = YAMAHA ID 0001nnnn 1n = Device Number n=always 0 (when transmit), n=0-F (when receive) 01001100 4C = Model ID 0hhhhhhh hh = Address High 0mmmmmmm mm = Address Mid 0lllllll ll = Address Low 0ddddd dd = Data ... 11110111 F7 = End of Exclusive	○ Refer to Parameter Change Table		×	×
XG Bulk Dump	F0 43 0n 4C aa bb hh mm ll dd ... dd cc F7 11110000 F0 = Exclusive status 01000011 43 = YAMAHA ID 0000nnnn 0n = Device Number n=always 0 (when transmit), n=0-F (when receive) 01001100 4C = Model ID 0aaaaaaa aa = Byte Count MSB 0bbbbbbb bb = Byte Count LSB 0hhhhhhh hh = Address High 0mmmmmmm mm = Address Mid 0lllllll ll = Address Low 0ddddd dd = Data : : 0ddddd dd = Data 0cececcc cc = Checksum 11110111 F7 = End of Exclusive	○ Refer to Parameter Change Table		×	×
XG Parameter Request	F0 43 3n 4C hh ll F7 11110000 F0 = Exclusive status 01000011 43 = YAMAHA ID 0011nnnn 3n = Device Number n=always 0 (when transmit), n=0-F (when receive) 01001100 4C = Model ID 0hhhhhhh hh = Address High 0mmmmmmm mm = Address Mid 0lllllll ll = Address Low 11110111 F7 = End of Exclusive	○ Refer to Parameter Change Table		×	×
XG Dump Request	F0 43 2n 4C hh mm ll F7 11110000 F0 = Exclusive status 01000011 43 = YAMAHA ID 0010nnnn 2n = Device Number n=always 0 (when transmit), n=0-F (when receive) 01001100 4C = Model ID 0hhhhhhh hh = Address High 0mmmmmmm mm = Address Mid 0lllllll ll = Address Low 11110111 F7 = End of Exclusive	○ Refer to Parameter Change Table		×	×

■ System Exclusive Messages (Others)

MIDI Event	Data Format	[MIDI (Silent)]			
		MIDI Reception		MIDI Transmission	
		Song Part	Piano Playback Channel	Panel Operation	Song Playback
MIDI Master Tuning	F0 43 1n 27 30 00 00 mm ll cc F7 11110000 F0 = Exclusive status 01000011 43 = YAMAHA ID 0001nnnn 1n = always 0 (when transmit), n=0-F (when receive) 00100111 27 = Model ID of TG100 00110000 30 = Address High 00000000 00 = Address Mid 00000000 00 = Address Low 0000mmmm 0m = Master Tune MSB 0000llll 0l = Master Tune LSB 0cececcc cc = don't care 11110111 F7 = End of Exclusive	×	×	×	×

■ System Exclusive Messages (Preset Voice)

MIDI Event	Data Format	[MIDI (Silent)]			
		MIDI Reception		MIDI Transmission	
		Song Part	Piano Playback Channel	Panel Operation	Song Playback
String Resonance Depth	F0 43 73 01 50 11 0n 02 dd F7 11110000 F0 = Exclusive status 01000011 43 = YAMAHA ID 01110011 73 = Clavinova ID 00000001 01 = Model ID (Clavinova common ID) 01010000 50 = SubID 00010001 11 = SubID 0000nnnn 0n = Channel (00-0F) 00000010 02 = SubID (String Resonance Depth) 0ddddd dd = Depth (00-48) 11110111 F7 = End of Exclusive	○	×	×	×
Sustain Sample Depth	F0 43 73 01 50 11 0n 03 dd F7 11110000 F0 = Exclusive status 01000011 43 = YAMAHA ID 01110011 73 = Clavinova ID 00000001 01 = Model ID (Clavinova common ID) 01010000 50 = SubID 00010001 11 = SubID 0000nnnn 0n = Channel (00-0F) 00000011 03 = SubID (Sustain Sample Depth) 0ddddd dd = Depth (00-48) 11110111 F7 = End of Exclusive	○	×	×	×
Key Off Sampling Depth	F0 43 73 01 50 11 0n 04 dd F7 11110000 F0 = Exclusive status 01000011 43 = YAMAHA ID 01110011 73 = Clavinova ID 00000001 01 = Model ID (Clavinova common ID) 01010000 50 = SubID 00010001 11 = SubID 0000nnnn 0n = Channel (00-0F) 00000100 04 = SubID (Key Off Sampling Depth) 0ddddd dd = Depth (00-50) 11110111 F7 = End of Exclusive	○	×	×	×
Soft Pedal Depth	F0 43 73 01 50 11 0n 05 dd F7 11110000 F0 = Exclusive status 01000011 43 = YAMAHA ID 01110011 73 = Clavinova ID 00000001 01 = Model ID (Clavinova common ID) 01010000 50 = SubID 00010001 11 = SubID 0000nnnn 0n = Channel (00-0F) 00000101 05 = SubID (Soft Pedal Depth) 0ddddd dd = Depth (00-7F) 11110111 F7 = End of Exclusive	○	×	×	×

* For each depth value, the rest value is 40H = voice parameter.

MEMO

MIDI IMPLEMENTATION CHART

Yamaha Disklavier
Model: ENSPIRE ST/PRO

Date: 01-APR-2016
Version: 1.00

Function...		Transmitted	Recognized	Remarks
Basic Channel	Default Changed	1-16 1-16	1-16 1-16	Memorized
Mode	Default Messages Altered	3 × *****	3 3, 4 (m=1) *1, *2 ×	
Note Number	: True Note	○ 21-108 *****	0-127 0-127	
Velocity	Note ON Note OFF	○ 9nH, v=1-127 ○ 8nH, v=0-127	○ v=1-127 ○	
After Touch	Key's Ch's	○ *4 ×	× ×	
Pitch Bend		×	○ 0-24 semi *1	
Control Change	0, 32 7, 11 1, 5, 10 6, 38 64 65 66 67 71-74, 84 91, 93, 94 96-101	× × × × ○ × ○ *3 ○ × × ×	○ *1 ○ ○ *1 ○ *1 ○ ○ *1 ○ *1 ○ ○ *1 ○ *1 ○ *1	Bank Select Data Entry Hold1 (Sustain) Portamento Sostenuto Soft (Shift) Pedal Effect Depth
Prog Change	: True #	× *****	○ 0-127	
System Exclusive		○	○	
Common	: Song Pos : Song Sel : Tune	× × ×	× × ×	
System Real Time	: Clock : Commands	× ×	× ×	
Aux Messages	: All Sound OFF : Reset All Cntrls : Local ON/OFF : All Notes OFF : Active Sense : Reset	○ × × ○ ○ ×	○ (120, 126, 127) ○ (121) ○ ○ (123-125) ○ ×	
Notes	*1 = Only ESBL Part can recognized. *2 = m is always treated as 1 regardless of value. *3 = Transmit if this model has a Sostenuto Pedal. *4 = Applying further pressure on the key does not output key aftertouch information.			

Mode 1 : OMNI ON. POLY Mode 2 : OMNI ON. MONO ○ : YES
 Mode 3 : OMNI OFF. POLY Mode 4 : OMNI OFF. MONO × : NO



YAMAHA CORPORATION
10-1 Nakazawa-cho, Naka-ku,
Hamamatsu, 430-8650 Japan

Copyright © 2016 Yamaha Corporation
Published 01/2023 MW-A0

YN640A0