

PC412-D PC412-DI PC406-D PC406-DI

Owner's Manual

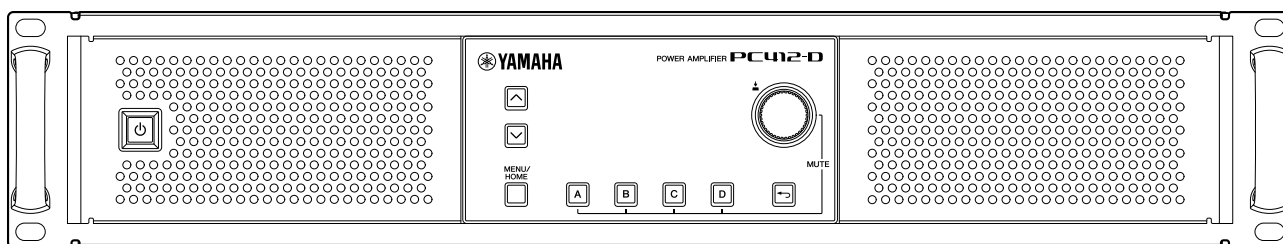

POWER AMPLIFIER

Table of contents

1. Introduction	1
1.1. Symbols used in this manual	1
1.2. About this owner's manual	1
1.3. Features	2
1.4. Included items	2
1.5. Documentation	2
1.6. About ProVisionaire Amp Editor	3
1.7. Firmware updates	3
1.8. Signal processing in the PC-D/DI series	4
1.9. Input sensitivity and amp gain	4
2. Panel descriptions	5
2.1. Front panel	5
2.2. Rear panel	6
3. Preparations	9
3.1. Precautions for rackmounting	9
3.2. Filter element and grill installation	9
4. Connections	11
4.1. Audio input connections	11
4.2. Connections using the [GPI IN / OUT] connectors	12
4.3. Speaker cable selection	14
4.4. Speaker connections	15
4.5. High impedance connections (PC-DI series only)	17
4.6. Power supply connection	18
4.7. Switching the power between standby/on	19
5. Panel operations	20
5.1. Basic operations	20
5.2. HOME screen	21
5.3. MATRIX/ROUTER page	23
5.4. DEVICE MUTE page	23
5.5. VOLUME page	23
5.6. USER EQ page	24
5.7. USER DELAY page	25
5.8. SPEAKER PROCESSOR page	26
5.9. SPEAKER PRESET page	26
5.10. AMP SETTINGS page	27
5.11. LOAD MONITORING page	27
5.12. MENU screen	28
5.13. Alert screen	28
6. AMP PRESET screen	29
6.1. RECALL	31
6.2. STORE	31
6.3. CLEAR	31
6.4. TITLE	32
6.5. FOCUS	32
6.6. PROTECT	33
6.7. INFO (information)	33
7. SETUP screen	34
7.1. AMP SETTINGS	34
7.2. CHANNEL NAME	35
7.3. AUTO SLEEP	36

7.4. INPUT REDUNDANCY	37
7.5. LOAD MONITORING	39
7.6. POWER SUPPLY	40
7.7. GPI	41
8. PROCESSING screen	43
8.1. INPUT ALIGNMENT	43
8.2. INPUT	43
8.3. MATRIX	44
8.4. ROUTER	45
8.5. USER EQ/DELAY	46
8.6. SPEAKER PROCESSOR	47
9. NETWORK screen	53
9.1. DEVICE	53
9.2. Dante	54
9.3. CONTROL	56
10. UTILITY screen	57
10.1. PANEL SETUP	57
10.2. Specifying the PIN code	58
10.3. To defeat panel lock	59
10.4. HOME SCREEN	60
10.5. DEVICE INFORMATION	60
10.6. CLOCK	61
10.7. INITIALIZE	61
10.8. REBOOT	61
10.9. LOG	62
11. About Dante	64
11.1. Connection methods	65
11.2. Dante settings	67
11.3. Connections to Dante devices	67
12. Returning to the factory settings (initialization)	69
12.1. By selecting MENU screen → UTILITY → INITIALIZE	69
12.2. Initialization if you have forgotten the PIN code, etc.	70
13. Reference	71
13.1. Installing the handles	71
13.2. Cleaning the air filters	71
13.3. Function list	72
13.4. Message list	77
13.5. Troubleshooting	84
13.6. General specifications	86
13.7. Current draw	90
13.8. Dimensions	97
13.9. Block Diagram	97

1. Introduction

Thank you for purchasing a Yamaha PC-D/DI series power amplifier (see lineup table below). This product is a power amplifier used for fixed installations such as a hall or church, or for speeches or live events indoor or outdoor. This operating manual is intended to be read by the installer or system designer; it explains settings and installation. In order to take full advantage of this product's numerous functions, please read this owner's manual before use. After reading, keep it safe for future reference.

NOTE





- Unless otherwise specified, the illustrations show the PC412-D and PC406-D.

PC-D/DI series lineup

Output specifications	Standalone model (-D)	Model for installation (-DI)
1200W×4	PC412-D	PC412-DI
600W×4	PC406-D	PC406-DI

1.1. Symbols used in this manual

The symbols used on this product and in this manual have the following meaning.

Symbol	Meaning
 WARNING	Content describing a situation that might cause death or severe injury.
 CAUTION	Content describing a situation that might cause injury.
 NOTICE	Content describing a situation that might cause malfunction, damage, faulty operation, or loss of data.
 NOTE	Information regarding operation and use. Read this for your reference.

1.2. About this owner's manual

- All illustrations and screens shown in this manual are for explanatory purposes.
- Windows is a registered trademark of Microsoft Corporation USA in the USA and in other countries.
- Company names and product names appearing in this document are the registered trademarks or trademarks of their respective corporate owners.
- Software may be updated without notice for improvement.

1.3. Features

- Four-channel power amp with both high audio quality and high power
- Equipped with a variety of signal processing functionality such as PEQ and FIR filter
- 20×8 matrix function allows flexible audio routing
- Allows high-quality digital audio transmission via a Dante network
- Supports software such as ProVisionaire Amp Editor and ProVisionaire Control for each phase of system design and operation
- Supports both high-impedance connections and low-impedance connections (PC-DI series only)

1.4. Included items

- Power cord ×1
- Handles ×2
- Grill L ×1
- Grill R ×1
- Filter element L ×1
- Filter element R ×1
- Small screws for handle (M5×12mm)×4
- Euroblock plug mini for GPI (8-pin)×2
- Euroblock plug for analog input (3-pin)×4 (PC-DI series only)
- Euroblock plug for speaker output (8-pin)×1 (PC-DI series only)
- Cable ties ×4 (PC-DI series only)
- 2-conductor–3-conductor adaptor (PC406-D and PC406-DI only)
- Quick Start Guide

1.5. Documentation

- **Quick Start Guide (packaged with the product)**
This explains installation and basic use.
- **Owner's Manual (this document)**
This explains all items necessary for setup and operation.
- **ProVisionaire Amp Editor Setup Guide (HTML)**
This explains how to use the ProVisionaire Amp Editor software to control this product from a computer.

1.6. About ProVisionaire Amp Editor

ProVisionaire Amp Editor is software that lets you use your computer to construct, monitor, and control a system of network-capable amps (such as the XMV series) including this product. ProVisionaire Amp Editor allows centralized monitoring or control of multiple connected devices.

You can download ProVisionaire Amp Editor from the Yamaha Pro Audio website.

<http://www.yamahaproaudio.com/>

1.7. Firmware updates

This product is designed to allow its firmware to be updated in order to improve its operability, add functionality, or fix problems. This product has the following two firmware items.

- Firmware of the unit itself
- Firmware of the Dante module

The process of updating the firmware of the unit itself is performed from ProVisionaire Amp Editor. The process of updating the firmware of the Dante module is performed from Dante Firmware Update Manager.

For details on the update procedure and settings for the unit, refer to "ProVisionaire Amp Editor Setup Guide."

NOTE

- It will be necessary to update other devices depending on the version of each device in the Dante network. For details, refer to the firmware compatibility chart provided on the above Yamaha website.

1.8. Signal processing in the PC-D/DI series

PC-D/DI series units consist of three blocks: INPUT, USER, and SPEAKER PROCESSOR. INPUT specifies the routing, and USER EQ and USER DELAY apply acoustical adjustments. SPEAKER PROCESSOR applies acoustical adjustments as appropriate for the speakers.

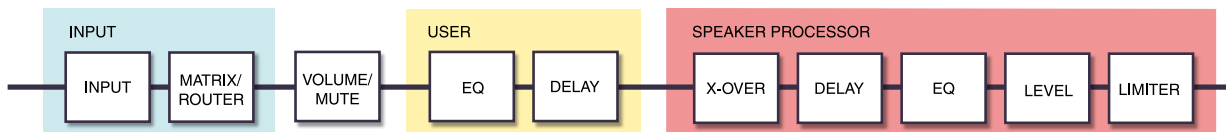

For details on these types of processing, refer to the sections of "[PROCESSING screen](#)."

1.9. Input sensitivity and amp gain

The PC-D/DI series lets you specify input sensitivity and amp gain settings using two types of input sensitivity or two types of amp gain. Input sensitivity is the input signal level that produces maximum output. When a signal that exceeds the input sensitivity is input, a limiter inside the PC-D/DI series unit is applied. Reducing the volume raises the input sensitivity and lowers the amp gain. Reducing the volume does not change the maximum output. For example on the PC412-D if you set amp gain to 32 dB, the maximum output will be 1200W and the input sensitivity will be +10 dBu (when speaker impedance is 8Ω). If the volume is not reduced (0 dB), an input of +10 dBu produces 1200W output. Reducing the volume 10 dB makes the input sensitivity of the PC412-D be +20 dBu (= +10 dBu + 10 dBu), and the amp gain will be 22 dB (= 32 dB - 10 dB). An input of +20 dBu produces 1200W maximum output.

■When the PC412-D's amp gain setting is 32 dB

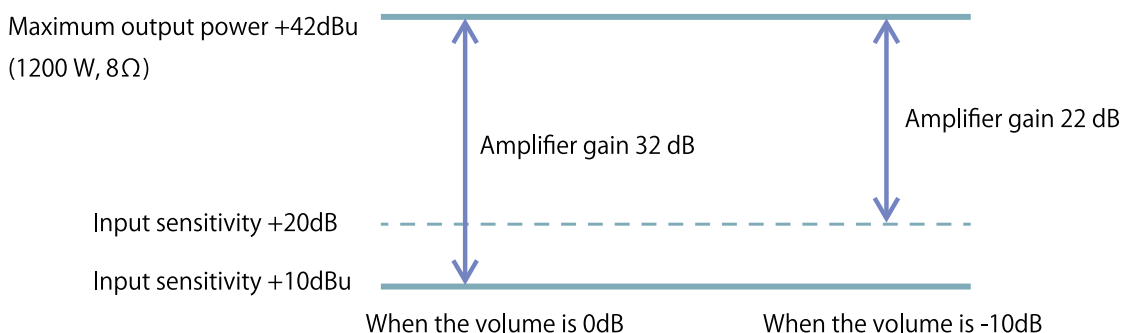

2. Panel descriptions

2.1. Front panel

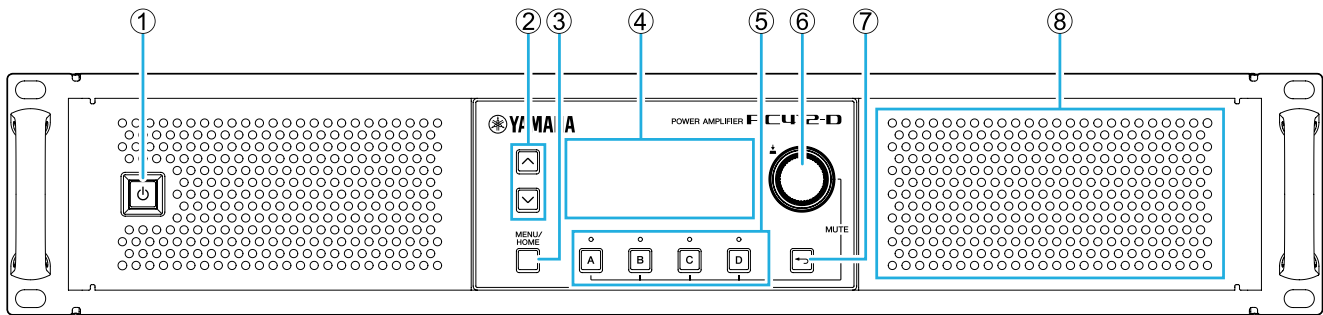

① Power switch

This switch turns the power on/off. The switch is lit when the power is on, and dimmed when in standby mode.



WARNING

- To prevent loud noise from being emitted from the speaker when the power is turned on, power-on each unit in the order of audio sources, mixer, and finally the amp. When turning the power off, reverse this order.

② [▲][▼] keys

These keys switch pages (UP/DOWN).

③ [MENU/HOME] key

This key switches between the MENU screen and the HOME screen.

④ Display

This shows the status of the amp and the menu of settings.



NOTE

- You can make settings so that the display and indicator are automatically dimmed when panel operations are not being performed ([AUTO DIMMER](#)).
- To protect the display, the display indication disappears when no operation is performed for 30 minutes. To bring back the display, press any front panel key or knob.

⑤ Channel select keys/indicators

Use these keys to select the channel that you want to operate (channel A, B, C, or D). The indicators show the status of the output to the speakers.

Indication	Status
Green	A signal above -60 dBFS is being output
Yellow	Limiters is applied
Red (lit)	Mute is ON

Indication	Status
Red (flashing)	The indicator flashes in the following situations - Muted by the solo function - Muted by the protection function - Device mute - Sleeping

 NOTE

- To switch mute on/off, hold down a channel select key and press the main knob.

⑥ **Main knob**

Turn this knob to select the parameter that you want to edit, or to change the value of the parameter. Press the main knob to confirm.

⑦ **[↔](back) key**

Press this button to return to the previous screen. If you long-press this for one second or longer, you return to the HOME screen.

⑧ **Cooling intake vent**

This is an intake vent for the cooling fan. Because cooling air is drawn in through this vent, take care that it is not blocked by an obstruction.

2.2. Rear panel

• **PC-D series**

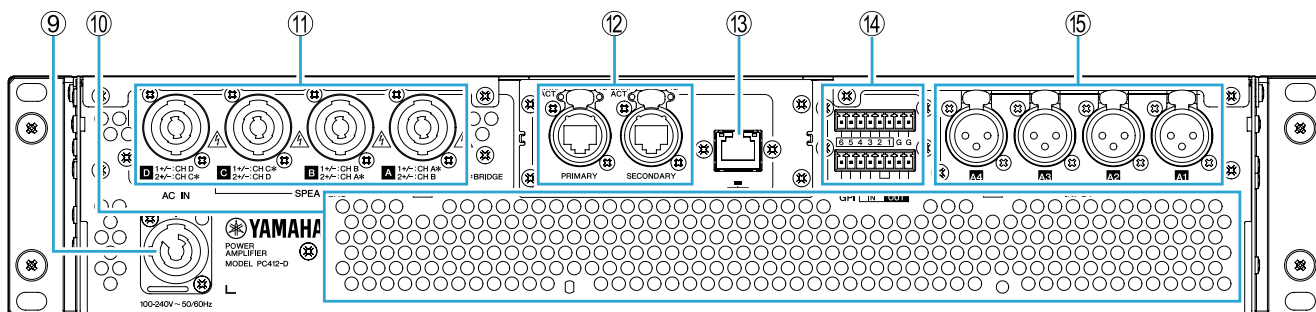

• **PC-DI series**

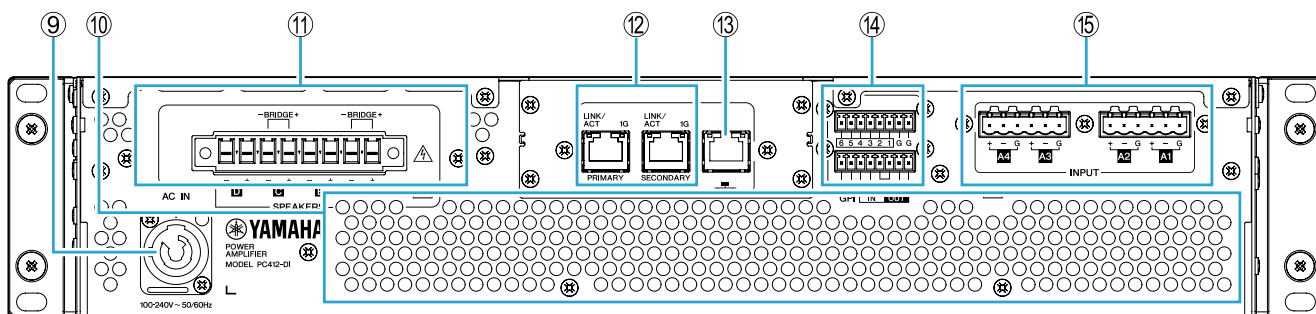

⑨ **AC IN connector**

Connect the included power cord. Connect the power cord to the unit, and then connect the power plug to an electrical outlet.

When connecting the power cord, insert it all the way, and then twist it clockwise until you hear the click. When

removing the power cord, pull the latch toward yourself, turn the connector counterclockwise, and remove it.



WARNING

- You must use the included power cord. Do not use the included power cord with any other product. Doing so may cause malfunction, overheating, and fire.



NOTICE

- When this product is connected to an AC outlet, it is in standby mode, and a small amount of current is flowing. If you will not be using this product for an extended period of time, be sure to disconnect the power supply plug from the AC outlet.
- Position the power cord so that the rear exhaust does not contact it directly. The temperature of the rear exhaust might cause the power cord to deform.

⑩ Exhaust vent

This is an exhaust vent for the cooling fan. Because warm air is expelled through this vent, take care that it is not blocked by an obstruction.

⑪ [SPEAKERS] A/B/C/D connectors

These are the output connectors to the speakers. There are the following two types of connector.



WARNING

- Do not touch the pins of unused channels, or allow them to short. High voltage is present even at unused pins.

• PC-D series

Four Speakon output jacks (NL4) are used to connect speakers. The outputs of this product can be bridged in pairs of two channels.

There are no dedicated outputs for use in bridge mode. For the pin assignments, refer to "[Speaker connections](#)."

• PC-DI series

This product uses Euroblock connectors (7.6 mm 8-pin) for speaker connections. The outputs of this product can be bridged in pairs of two channels.

There are no dedicated outputs for use in bridge mode. For the pin assignments, refer to "[Speaker connections](#)."

⑫ Dante [PRIMARY]/[SECONDARY] ports

This is an etherCON (RJ-45) port for connection to a CL-series unit or other Dante device via an Ethernet cable (CAT5e or better is recommended). For the PC-D series, use RJ-45 connectors that comply with Neutrik Corporation's etherCON CAT5. For the PC-DI series, use RJ-45 connectors.

 NOTE

- To prevent electromagnetic interference, use STP (Shielded Twisted Pair) cables. For STP cables, use conductive tape to securely connect the metal portion of the connector to the shielded portion of the cable.

⑬ NETWORK port

This is an RJ-45 port for connection to a computer via an Ethernet cable (CAT5e or better is recommended). This is used mainly to monitor and control multiple connected devices from the dedicated "ProVisionaire Amp Editor" application program.

 NOTE

- To prevent electromagnetic interference, use STP (Shielded Twisted Pair) cables.

⑭ GPI connectors

These are 3.5mm Euroblock connectors for GPI (General Purpose Interface) use to input and output control signals. This product has six input ports and four output ports. The [IN]-1–6 pins detect voltages for a "L" signal (0V) or a "H" signal (5V). The [OUT]-1–4 pins output a "L" signal (0V) or a "H" signal (5V).

To make connections, use the included Euroblock plug.

For details on connection methods and examples of use, refer to "[Connections using the \[GPI IN / OUT\] connectors.](#)"

⑮ [INPUT] A1/A2/A3/A4 connectors

These are analog input connectors. There are two types of connector.

• **PC-D series**

These are XLR-3-31 type balanced jacks that input an analog signal to each channel.

• **PC-DI series**

These are Euroblock 3-pin jacks that input an analog signal to each channel.

3. Preparations

3.1. Precautions for rackmounting

This product is guaranteed to operate in a temperature range of 0–40 degrees. If only this product is being mounted in an EIA standard rack, multiple units can be mounted without leaving space between them. If this product is being mounted in an EIA standard rack together with other devices, heat from each device might cause the temperature inside the rack to rise, preventing this product from operating to its full potential. To prevent heat buildup inside this product, you must observe the following conditions when mounting it in a rack.

- If this product is mounted together with devices that tend to become hot, such as power amps made by other manufacturers, leave 1U or more of space between this product and other devices. Install a ventilation panel in this space or leave it open to ensure sufficient airflow.
- Since this product takes in air at the front and exhausts it at the back, you should not rack-mount it together with devices that take in air at the back and exhaust it at the front.
- Leave the back panel of the rack open, and keep the rack at least 10 cm away from the wall or ceiling to ensure sufficient airflow. If the back panel of the rack cannot be left open, attach a commercially available fan kit or other forced air exchange device. If a fan kit is installed, closing the back panel of the rack might increase the heat dissipation effect in some cases. For details, refer to the owner's manual of your rack and fan kit.

3.2. Filter element and grill installation

Install the included filter elements and grills. Note that the size of the filter elements differs between left and right. The grills are held in place magnetically, and can be easily attached.

Fit the filter elements into the brackets of the unit; then attach grill "L" to the left side of the unit's front panel and attach grill "R" to the right side of the front panel.

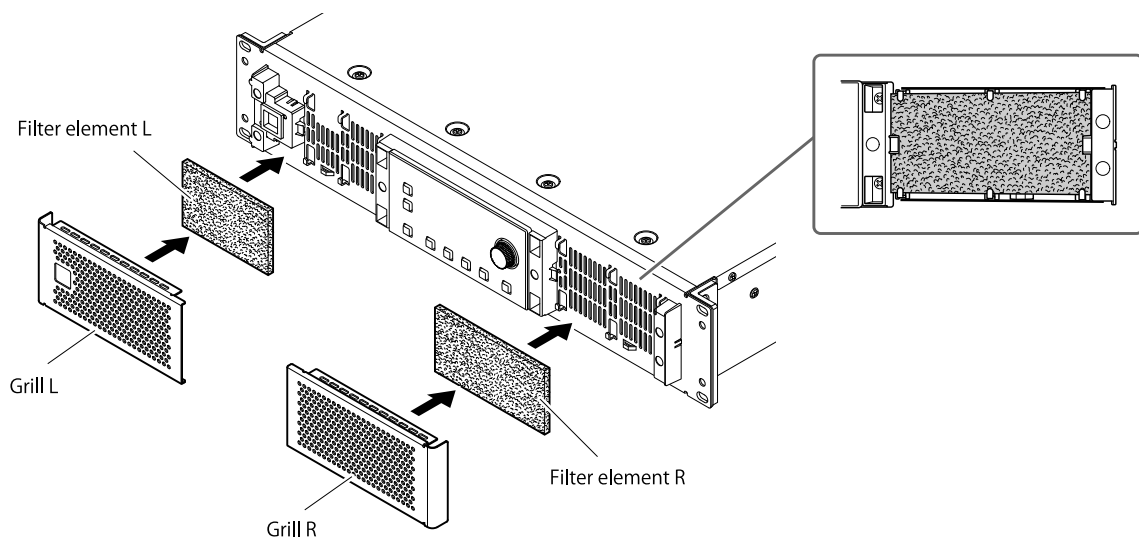

 NOTE

- To prevent the grills from being lost, you can attach the grills to the ventilation openings using a cable tie or something similar.

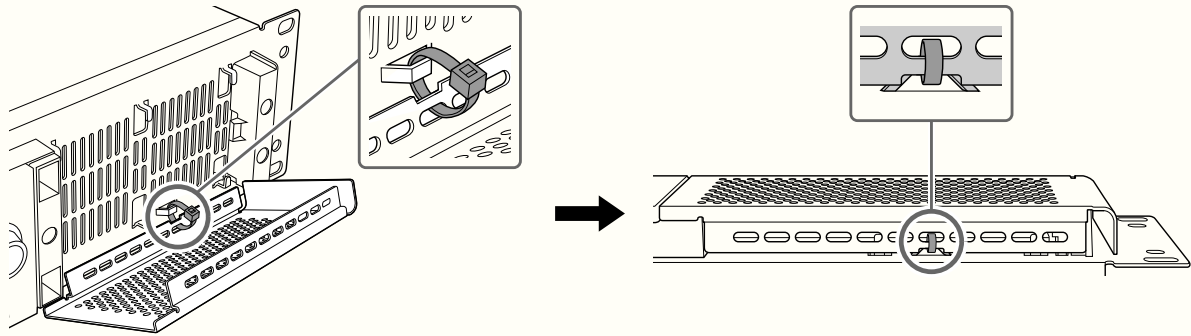

4. Connections

4.1. Audio input connections



WARNING

- Unplug the device from mains before connecting or disconnecting any cable to it.

• For the PC-D series

Connect the rear panel XLR jacks to the balanced outputs of the mixer, and input analog signals. The jack polarity is shown in the illustration below (IEC 60268).

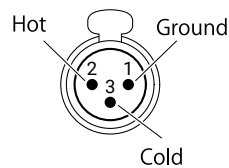

• For the PC-DI series

- When attaching a cable to a Euroblock plug, strip the wire as shown in the illustration, and use stranded wire to make connections. In the case of Euroblock wiring, stranded wire may break more easily due to metal fatigue caused by the weight or vibration of the cable. Use the included cable ties to secure the cables to the tab.

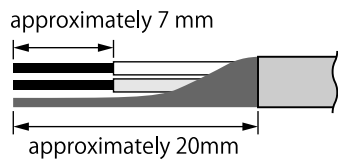

CAUTION

- When using stranded wire, do not tin the strands with solder.
- If connections will be frequently plugged and unplugged, as in a portable setup, we recommend that you use rod terminals equipped with insulating sleeves. Use rod terminals whose conductor section is as shown below.

5.08 mm Euroblock 6-pin

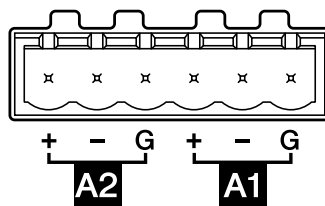

External diameter 1.6 mm or less, and length approximately 7 mm (such as the A10, 5-6WH made by the Phoenix Contact company)

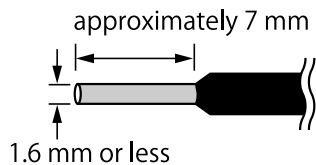

4.2. Connections using the [GPI IN / OUT] connectors

The GPI connectors on the rear panel can be used as GPI (General Purpose Interface) input/output connectors. These connectors provide six GPI IN ports and four GPI OUT ports. For example you could use an external switch to control parameters inside the PC-D/DI series unit, or cause operations on the PC-D/DI series unit to send control signals to an external device.

The following illustration shows an example of an external circuit that controls GPI via a GPI connector. The [IN]-1–6 pins detect voltages for a "L" signal (0V) or a "H" signal (5V). The [OUT]-1–4 pins output a "L" signal (0V) or a "H" signal (5V).

Example: Using a switch to control the PC-D/DI series unit	Example: Illuminating the LED of an external device from the PC-D/DI series unit
<p style="text-align: center;">GPI Connection</p> <p>A circuit diagram showing a GPI IN pin connected to one terminal of a switch. The other terminal of the switch is connected to a +V pin. The other end of the +V pin is connected to ground.</p>	<p style="text-align: center;">GPI Connection</p> <p>A circuit diagram showing a GPI OUT pin connected to the anode of an LED. The cathode of the LED is connected to a resistor, which is then connected to a GND pin. A label indicates a maximum current of 16mA.</p>

4.2.1. Cable management

- When attaching a cable to a Euroblock plug, strip the wire as shown in the illustration, and use stranded wire to make connections. In the case of Euroblock wiring, stranded wire may break more easily due to metal fatigue caused by the weight or vibration of the cable. Use the included cable ties to secure the cables to the tab.

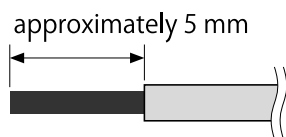

CAUTION

- When using stranded wire, do not tin the strands with solder.

- If connections will be frequently plugged and unplugged, as in a portable setup, we recommend that you use rod terminals equipped with insulating sleeves. Use rod terminals whose conductor section is as shown below.

External diameter 1.3mm or less, and length approximately 5mm (such as the A10, 5-6WH made by the Phoenix Contact company)

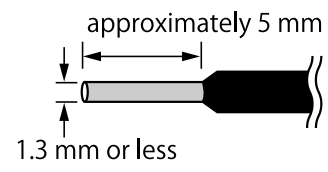

4.3. Speaker cable selection



WARNING

- The output jacks of the power amp carry high voltage. When connecting this unit to speakers, you must use cables that at a minimum satisfy the requirements of NEC (National Electrical Code) UL13 CL3 (300V or less).

To minimize power loss or damping factor loss in speaker cables, refer to the following table and use speaker cable of the appropriate gauge.

Load impedance (Ohms)	2	2.6	4	8
Cable	Maximum cable length (m)			
2.5mm ² (AWG 13)	20	28	40	80
4mm ² (AWG 11)	32	40	64	128
6mm ² (AWG 9)	48	64	96	192



NOTE

- The Euroblock connectors of the PC-DI series should be used with AWG24 (0.2sq)–AWG8 (8sq) cables.

4.4. Speaker connections

• For the PC-D series

This product uses four Speakon output jacks (NL4) to connect speakers.

NeutrikNL4 plug

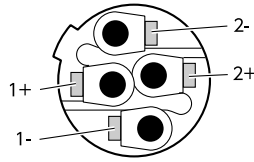

The outputs of this product can be bridged in pairs of two channels.

Since there are no dedicated outputs for use in bridge mode, take care to observe the following pin assignments.

		SINGLE	BRIDGE
NL4 A	1+	CH A+	CH A+
	1-	CH A-	CH A-
	2+	CH B+	-
	2-	CH B-	-
NL4 B	1+	CH B+	-
	1-	CH B-	-
	2+	CH A+	CH A+
	2-	CH A-	CH A-
NL4 C	1+	CH C+	CH C+
	1-	CH C-	CH C-
	2+	CH D+	-
	2-	CH D-	-
NL4 D	1+	CH D+	-
	1-	CH D-	-
	2+	CH C+	CH C+
	2-	CH C-	CH C-



WARNING

- Do not touch the pins of unused channels, or allow them to short. High voltage is present even at unused pins.

• **For the PC-DI series**

This product uses Euroblock connectors (7.6 mm 8-pin) for speaker connections. Insert the tip of a screwdriver into the square hold located on the top of the cable insertion opening. Inserting the screwdriver and lifting the internal spring allows the cable to be inserted or removed.

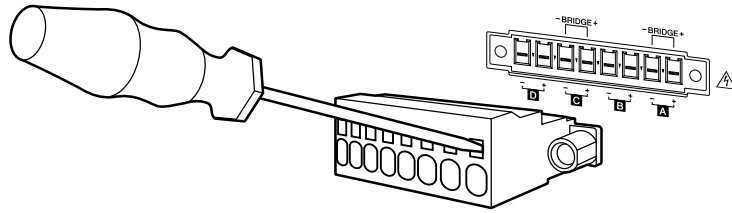

The outputs of this product can be bridged in pairs of two channels. Since there are no dedicated outputs for use in bridge mode, take care to observe the following pin assignments.

		SINGLE	BRIDGE
EURO A	+	CH A+	CH A+
	-	CH A-	CH A-
EURO B	+	CH B+	-
	-	CH B-	-
EURO C	+	CH C+	CH C+
	-	CH C-	CH C-
EURO D	+	CH D+	-
	-	CH D-	-



WARNING

- Do not touch the pins of unused channels, or allow them to short. High voltage is present even at unused pins.

4.5. High impedance connections (PC-DI series only)

The PC-DI series also supports high impedance (100V/70V line).

■ Number of speaker systems that can be driven

As long as the total rated input of the speaker systems used is within the output value of the power amp, any number of speaker systems can be connected in parallel.

When using high-impedance connections, the rated input of the speaker system is determined by the settings of the speaker transformer used with the speaker system.

If using the 600W output PC406-DI with a speaker system whose rated input is 20W due to the attached speaker transformer, calculations * show that we can use up to 30 speaker units per channel, and up to 120 speaker system units for the total of four channels.

A combination of speaker systems with different rated input can also be connected.

* In consideration of impedance variance in the primary side of the transformer, future change in transformer tap, and future addition of speakers, we recommend that you allow a margin of about 20%.

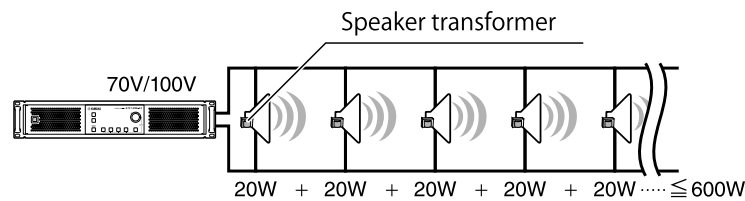

■ High-impedance connection example

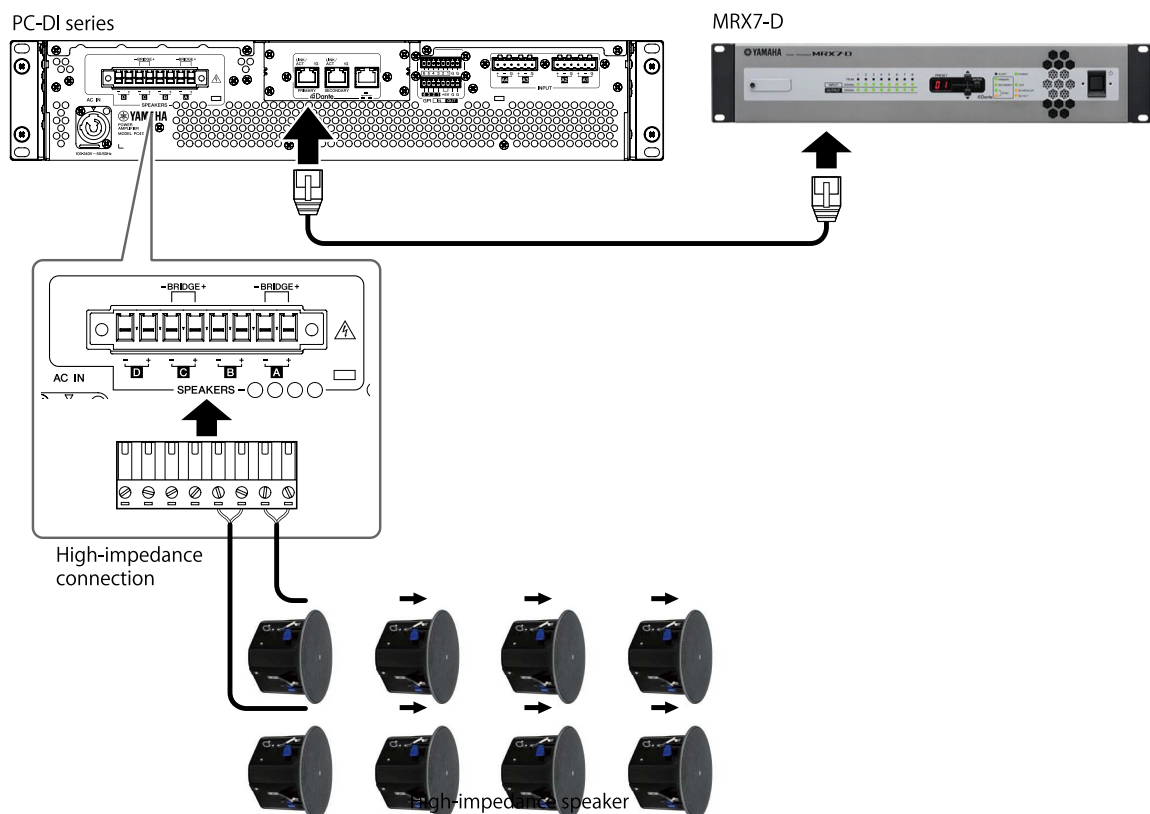

4.6. Power supply connection



WARNING

- You must use the included power cord. Do not use the included power cord with any other product. Doing so may cause malfunction, overheating, and fire.



NOTICE

- Position the power cord so that the rear exhaust does not contact it directly. The temperature of the rear exhaust might cause the power cord to deform.

1. Connect the included power cord.

First connect the power cord to the unit, and then connect the power plug to an electrical outlet. When connecting the power cord, insert it all the way, and then twist it clockwise until you hear the click. When removing the power cord, pull the latch toward yourself, turn the connector counterclockwise, and remove it.

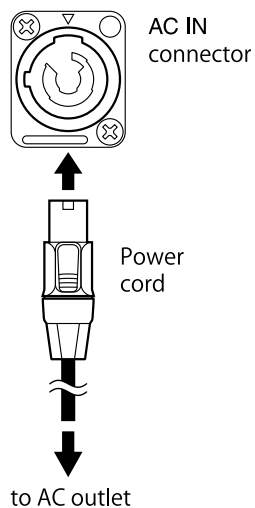

NOTE

- Turning the unit on and off in rapid succession by connecting and disconnecting the power plug can cause it to malfunction. After turning the unit off by disconnecting the power plug, wait for at least five seconds before reconnecting the power plug to turn the unit on.

4.7. Switching the power between standby/on

To prevent loud noise from being emitted from the speaker when the power is turned on, power-on each unit in the order of audio sources, mixer, and finally the amp. When turning the power off, reverse this order.

■ Standby → power on

1. **Hold down the power switch for two seconds or longer.**

The power turns on, and the button changes from blinking to lit (green). After a time, the HOME screen (VOLUME) appears.

■ Power on → standby

1. **Press the power switch.**

The display shows a confirmation message.

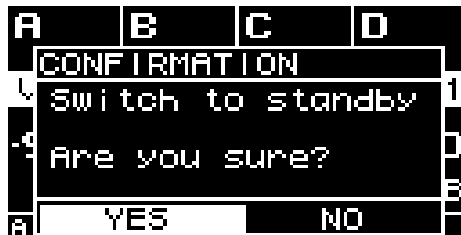

2. **Turn the main knob to select "YES," and then press the main knob to confirm; the power switches to standby mode.**

NOTE

- The settings at the time the power was turned off (the state when disconnected from the AC outlet) are saved. The next time the power is turned on, the unit starts up with those settings.

NOTICE

- When this product is connected to an AC outlet, it is in standby mode, and a small amount of current is flowing. If you will not be using this product for an extended period of time, be sure to disconnect the power supply plug from the AC outlet.

5. Panel operations

5.1. Basic operations

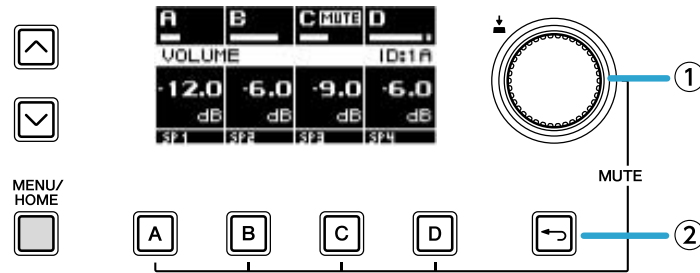

① Main knob

Use this to move the position of the cursor, or to modify the value of a parameter. For parameter values that have a wide range, the change accelerates according to the speed of rotation.

② [↶](back) key

Each time you press this, you move from the current level back to the level above or back to the previous screen.

1. Turn the main knob to select an item. The selected item is highlighted.

If a ► is shown at the right, the item has a further level below.



2. Press the main knob to confirm the selection.



3. Repeat steps 1 and 2 to proceed to the desired parameter edit screen.

Editing a selection-type parameter

Turn the main knob to make a selection. When you press the main knob to confirm, the value is updated and also applied to the sound.



4. For a selection-type parameter, press the main knob to confirm the edit.

[↶] Press the (back) key to move to the previous screen.

Editing a continuous-type parameter

Turn the main knob to edit the value of the parameter. The change is applied in real time.

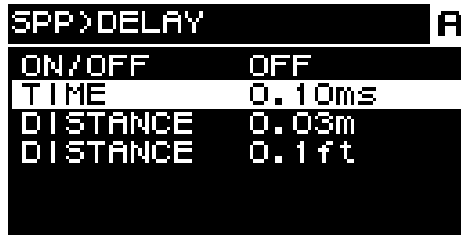

5.2. HOME screen

When you turn on the power switch, the home screen appears.

The center of the home screen (the area enclosed by a red frame) shows the important parameters for each basic function.

A highlighted channel indicates that it is selected as the target of operation.

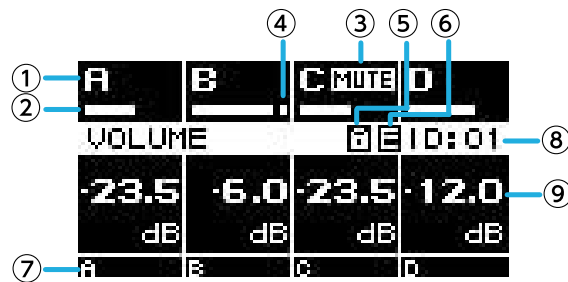

① Channel

② Meter

This shows the signal level of the channels (input or output) selected in the HOME SCREEN of UTILITY.

③ Mute indicator

This indicates when a channel is muted. The displayed content and status are as follows.

Indication	Status
MUTE	Channel mute is ON
SOLO	The corresponding channel is muted by the SOLO function
PROT	The corresponding channel is muted by the protect function
SLP	Sleeping due to AUTO SLEEP or CHANNEL SLEEP

④ Clip indicator

This indicates when the signal has clipped.

⑤ Panel lock symbol

This indicates that panel lock is enabled.

⑥ E symbol

When you recall a preset and then edit a parameter, an E symbol is shown.

⑦ Channel name

This shows the name assigned by CHANNEL NAME.

⑧ UNIT ID

This shows the UNIT ID assigned in the DEVICE screen.

⑨ Volume

This shows the output level.

When in BRIDGE mode, this shows the combined status of the paired channels.

A BRIDGE MUTE	C MUTE	D
VOLUME		E ID:01
-23.5	-23.5	-12.0
dB	dB	dB
A	C	D

5.2.1. Operations

The HOME screen contains the following pages.

- [MATRIX/ROUTER page](#)
- [DEVICE MUTE page](#)
- [VOLUME page](#)
- [USER EQ page](#)
- [USER DELAY page](#)
- [SPEAKER PROCESSOR page](#)
- [SPEAKER PRESET page](#)
- [AMP SETTINGS page](#)
- [LOAD MONITORING page](#)

- **To switch pages**

Use the [^][v] keys to switch pages.

- **To access the MENU screen**

In the HOME screen, press the [HOME/MENU] key.

5.3. MATRIX/ROUTER page

This page shows a list of the input signals being routed via the MATRIX and ROUTER to each channel.

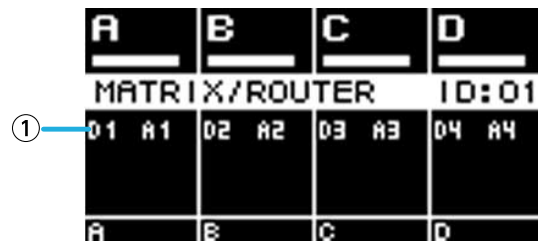

① Input source list

Analog inputs are shown as A1–A4, and Dante inputs are shown as D1–D16.

Use the channel select keys to select the channel that you want to operate, and then press the main knob to access the [AMP PRESET](#) screen.

5.4. DEVICE MUTE page

In this page you can set and view the mute status of the entire amp.

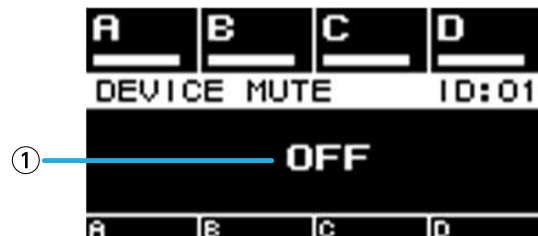

① ON/OFF

If this is on, the entire amp is muted. You can press the main knob to specify the mute status in the screen that appears.

5.5. VOLUME page

In this page you can set and view volume-related information.

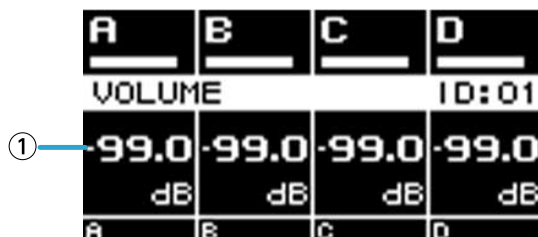

① Volume

This sets and shows the volume.

Use the channel select keys to select the channel that you want to operate, and then turn the main knob to change the volume.

If you select multiple channels, the channels will be linked, and you can change the volume while maintaining the difference between the channels.

5.6. USER EQ page

This page shows the EQ on/off status.

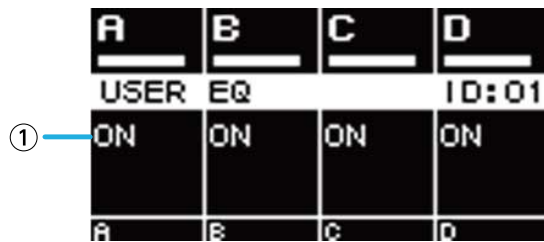

① EQ

This shows the EQ on/off status.

Use the channel select keys to select the channel that you want to operate, and then press the main knob to access the **USER EQ screen**.

If you select multiple channels, the channels will be linked for you to specify the EQ.

1. Use the channel select keys to select the channels that you want to link, and then press the main knob. A screen for selecting the EQ copy-source appears.

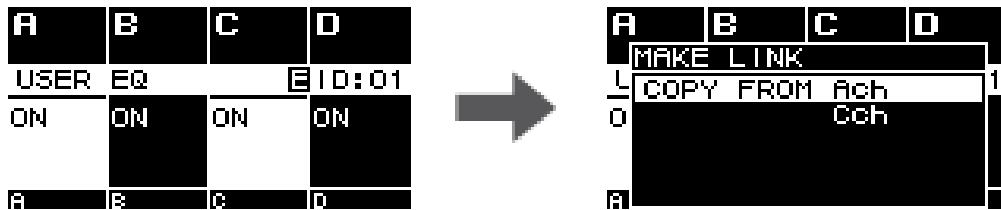

2. Turn the main knob to select the copy-source channel, and then press the main knob. The EQ setting screen appears in the channel-linked state.en



① Channel

This shows the linked channel names. If all four channels are linked this indicates "ALL."

NOTE

- Link is defeated when you leave the EQ screen.

5.7. USER DELAY page

In this page you can view delay-related information. The delay time can also be set.

	A	B	C	D
	USER DELAY			ID: 01
①	ON	ON	ON	ON
②	0.00 ms	0.00 ms	0.00 ms	0.00 ms
	A	B	C	D

① DELAY

This shows the DELAY on/off status.

② DELAY TIME

This sets and shows the delay time.

Use the channel select keys to select the channel that you want to operate, and then turn the main knob to change the delay time.

Use the channel select keys to select the channel that you want to operate, and then press the main knob to access the [USER DELAY screen](#).

If you select multiple channels, the channels will be linked, and you can change the delay time while maintaining the difference between the channels.

5.8. SPEAKER PROCESSOR page

This shows the SPEAKER PROCESSOR settings.

	A	B	C	D
	SP PROCESSOR			ID:01
①	XOU:0N	XOU:0N	XOU:0N	XOU:0N
②	EQ:0N	EQ:0N	EQ:0N	EQ:0N
③	LIM:0N	LIM:0N	LIM:0N	LIM:0N
	A	B	C	D

① XOV

This shows the crossover on/off status. This indicates OFF if both HPF and LPF are set to THRU, and otherwise indicates ON.

② EQ

This shows the EQ on/off status.

③ LIM

This shows the limiter on/off status. This indicates OFF if both Peak Limiter and RMS Limiter are set to OFF, and otherwise indicates ON.

Use the channel select keys to select the channel that you want to operate, and then press the main knob to access the [SPEAKER PROCESSOR](#) screen.

5.9. SPEAKER PRESET page

This shows the status of the speaker settings selected by SPEAKER PROCESSOR.

	A	B	C	D
	SPEAKER PRESET			ID:01
①	CHS18H _W_C2 R15	CZR15_ Pa_FIR	CHS18H _W_C2 R15	CZR15_ Pa_FIR
	A	B	C	D

① Speaker preset

This shows the name of the speaker preset for the recalled speaker.

Use the channel select keys to select the channel that you want to operate, and then press the main knob to access the [SP LIBRARY](#) screen.

5.10. AMP SETTINGS page

This shows information for the basic amp-related settings.

	A	B	C	D
	AMP SETTINGS			ID:01
①	+4dBu	+4dBu	+4dBu	+4dBu
②	70V	70V	Lo-Z	Lo-Z
③	80Hz	80Hz		
	A	B	C	D

① SENS./GAIN

This shows the input sensitivity or gain specified by SENS./GAIN.

② MODE (PC-DI series only)

This shows the MODE (Lo-z, 70V, 100V) of the speaker to be connected.

③ HPF (Hi-Z) (PC-DI series only)

If MODE (②) is 70V or 100V, this shows the cutoff frequency (40 Hz, 80 Hz) of the HPF (high pass filter) that is compulsorily applied.

Use the channel select keys to select the channel that you want to operate, and then press the main knob to access the [AMP SETTINGS](#) screen.

5.11. LOAD MONITORING page

This shows the impedance that is detected by LOAD MONITORING (Lo-z only).

	A	B	C	D
	LOAD MONITOR			ID:01
①	ON	ON	ON	ON
②	7.6	8.1	8.3	7.8
	Ω	Ω	Ω	Ω
	A	B	C	D

① ON/OFF

This indicates whether speaker impedance is monitored (ON) or not (OFF).

② Impedance

This shows the measured impedance.

Use the channel select keys to select the channel that you want to operate, and then press the main knob to access the [LOAD MONITORING](#) screen.

5.12. MENU screen

Here you can specify the basic status of the unit.

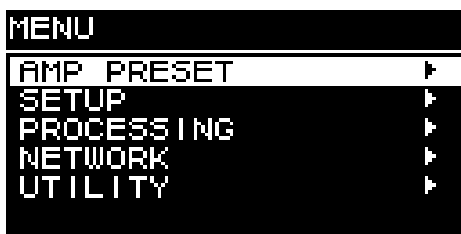

5.12.1. Operations

The MENU screen contains the following screens.

- [AMP PRESET screen](#)
- [SETUP screen](#)
- [PROCESSING screen](#)
- [NETWORK screen](#)
- [UTILITY screen](#)

- **To move to an upper level of the MENU screen**

[←] Press the (back) key.

NOTE

- The level of the displayed screen is indicated in the upper part of the screen.

- **To return to the HOME screen**

In the MENU screen, press the [HOME/MENU] key, or press the [←](back) key several times or long-press it.

5.13. Alert screen

If an abnormality occurs in the PC-D/DI series unit, the display shows an alert message.
For details on each alert, refer to "Message List."

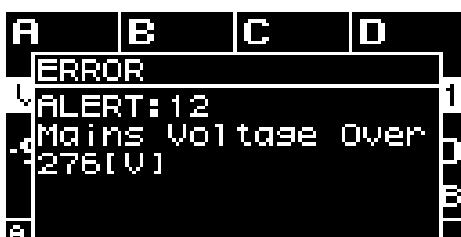

6. AMP PRESET screen

Here you can recall sound-related settings as amp presets. There are two types of presets: Factory Presets (which are read-only) and User Presets. An "*" is shown at the left of the last-recalled amp preset. When you edit a parameter, an (E symbol) appears in the HOME screen. When you recall, the E symbol disappears.



① Factory presets

These are five basic types of amp preset. These amp presets can be easily recalled to specify input signal routing that is appropriate for the system. The factory presets are read-only, and are always protected.

② User presets

Up to 32 user presets can be stored in the unit; you can recall or delete them, edit their title, or specify their protect setting. A protected amp preset is indicated by a lock symbol.

• Factory preset A: 4in-4out

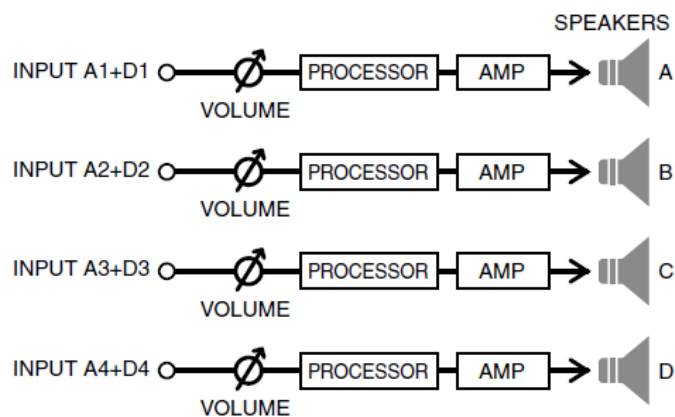

• Factory preset B: 2in-4out

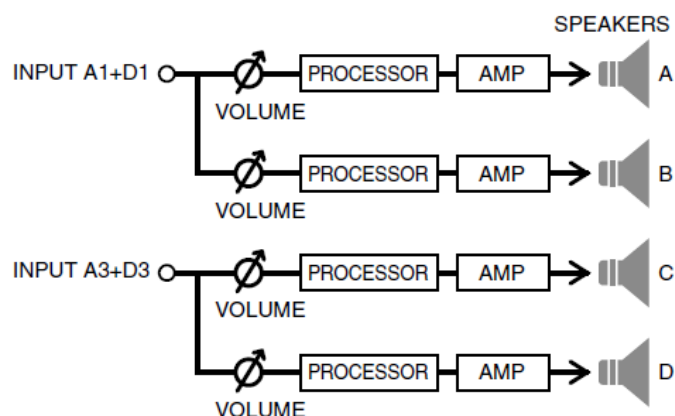

• **Factory preset C: 1in-4out**

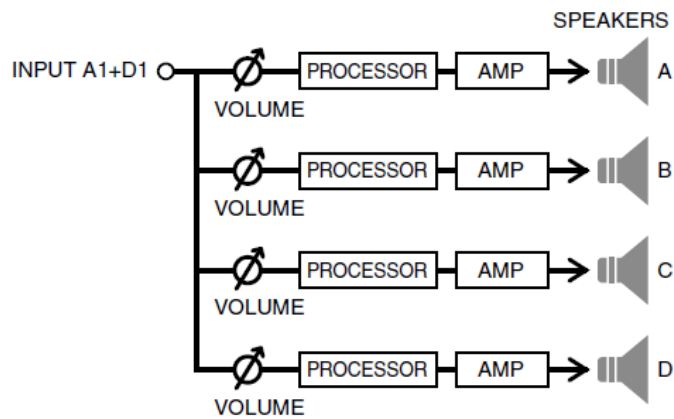

• **Factory preset D: 2in-2out BRIDGE**

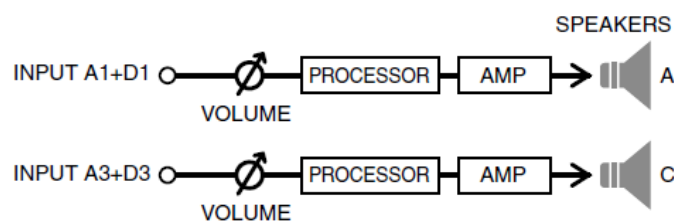

• **Factory preset E: 1in-2out BRIDGE**

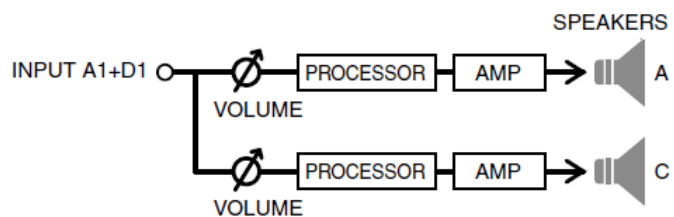

Turn the main knob to select the amp preset that you want to operate, and press the main knob to confirm. A screen for selecting the operation appears.

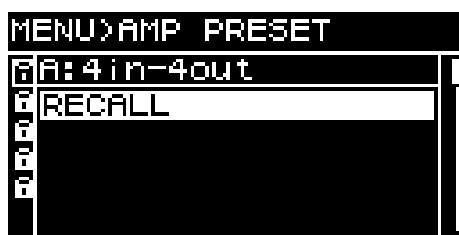

 **WARNING**

- For safety, do not input sound while recalling an amp preset. The volume might change significantly.

6.1. RECALL

This recalls a saved amp preset.
The list shows the preset numbers and titles.



6.2. STORE

This stores the current amp settings as an amp preset with the title that you assign.
Turn the main knob to select the position at which to input a character, and then press the main knob to enter character input mode. In character input mode, turn the main knob to select the character that you want to input, and then press the main knob to confirm the character.

If you move the cursor to BS and press the main knob, the last character is deleted.

In character input mode, pressing the [↵] (back) key takes you back to selecting the character position. In this state you can select OK to confirm the title, or select CANCEL to cancel input.

You can't overwrite onto an amp preset that is protected.



6.3. CLEAR

This erases a saved amp preset.



You can't erase an amp preset that is protected.

6.4. TITLE

This edits the title of a saved amp preset.

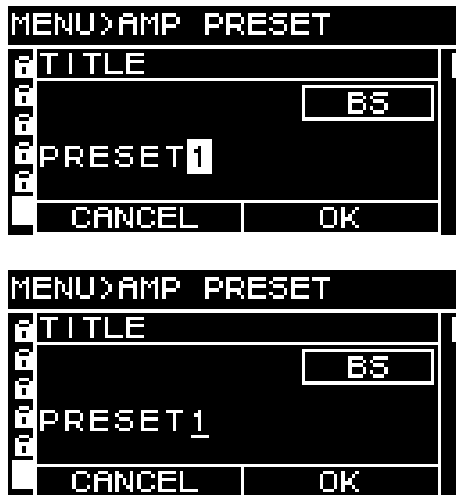

Turn the main knob to select the position at which to edit a character, and then press the main knob to enter character input mode. In character input mode, turn the main knob to select the character that you want to input, and then press the main knob to confirm the character.

If you move the cursor to BS and press the main knob, the last character is deleted.

In character input mode, pressing the [↵] (back) key takes you back to selecting the character position. In this state you can select OK to confirm the title, or select CANCEL to cancel editing.

You can't edit the title of an amp preset that is protected.

6.5. FOCUS

Here you can make and edit the focus recall settings. Focus is a function that selectively recalls parameters of an amp preset when that amp preset is recalled.

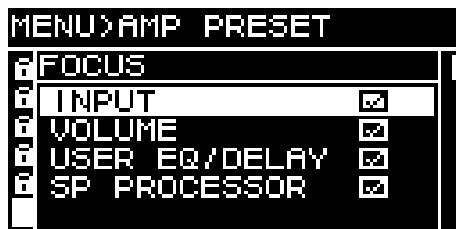

You can select multiple parameters as the object of focus.

You can't modify an amp preset that is protected.

6.6. PROTECT

Here you can turn protect on/off for a saved amp preset.



If this is ON, it will not be possible to overwrite (STORE), delete (CLEAR), or edit the title (TITLE) of the amp preset. Also, a lock symbol is shown at the left of the preset title in the PRESET screen.

6.7. INFO (information)

This shows the date and time at which the user preset was saved.



NOTE

- Set the time in the UTILITY screen's CLOCK page.
- You can use Provisionaire Amp Editor to apply the computer's time to this unit. For details, refer to the Provisionaire Amp Editor setup guide.

7. SETUP screen

7.1. AMP SETTINGS

Here you can make general settings for the amp.



① MODE (PC-DI series only)

This specifies whether the connected speaker is Hi-Z (high impedance) or Low-Z (low impedance). High impedance can be selected for 70V systems or 100V systems.

② HPF (Hi-Z) (PC-DI series only)

This specifies the HPF (high pass filter) that is compulsorily applied for Hi-Z (high impedance). The cutoff frequency can be selected as either 40 Hz or 80 Hz.

③ BRIDGE

This specifies whether adjacent odd-numbered and even-numbered channels will be bridge-connected to operate as a high-power amp. If this is ON, the amp gain is 6 dB higher than when it is OFF.

NOTE

- If bridge-connected, only channel A and channel B of the processing parameters are used.

④ CHANNEL SLEEP

If this is ON, channels that are not being used that day can sleep in order to conserve power and prevent overheating.

⑤ SENS./GAIN (input sensitivity / amp gain)

This specifies the input sensitivity or amp gain.

The input sensitivity can be selected as either 4 dBu or +14 dBu, and the amp gain can be selected as either 26 dB or 32 dB.

Sensitivity/Gain correspondence table	Sensitivity	Gain
PC412 (MAX:42.0dBu)	+4.0dBu	(38.0dB)
	+14.0dBu	(28.0dB)
	(+16.0dBu)	26.0dB
	(+10.0dBu)	32.0dB
PC406 (MAX:39.0dBu)	+4.0dBu	(35.0dB)
	+14.0dBu	(25.0dB)
	(+13.0dBu)	26.0dB
	(+7.0dBu)	32.0dB

 NOTE

- For safety, do not input sound while switching this setting. The volume might change significantly.
- For details on input sensitivity and amp gain, refer to "[Input sensitivity and amp gain.](#)"

7.2. CHANNEL NAME



① Channel name

This sets and shows the channel name. The specified channel name is shown in the lower part of the HOME screen.

Press the main knob to enter character input mode.

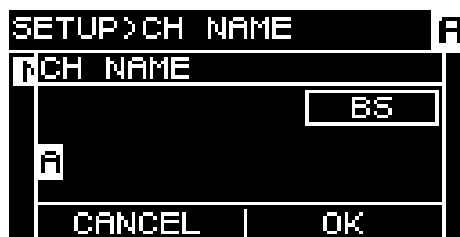

In character input mode, turn the main knob to select the location at which you want to input a character, and then press the main knob to confirm. Turn the main knob to select the character that you want to input, and then press the main knob to confirm the character.

If you move the cursor to BS and press the main knob, the last character is deleted.

In character input mode, pressing the [] (back) key takes you back to selecting the character position. In this state you can select OK to confirm the title, or select CANCEL to cancel input.

7.3. AUTO SLEEP

This function conserves power by automatically putting the unit to sleep after the specified time elapses with no input signal.

When an input signal is detected, sleep is automatically defeated.

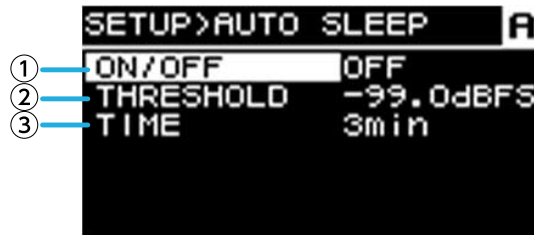

① ON/OFF

If this is on, the unit automatically sleeps when there has been no input signal for the specified time.

② THRESHOLD

This specifies the threshold value in dBFS units at which the presence or absence of an input signal is determined.

③ TIME

This specifies the time from when the input signal ceases until the unit enters sleep mode.

7.4. INPUT REDUNDANCY

The PC-D/DI series has two types of redundancy function as appropriate for the situation: "backup mode" and "override mode."

NOTE

- The INPUT REDUNDANCY function is independent of the Dante network's redundancy function.

• Backup mode

This automatically switches to a backup circuit if the Dante input audio is interrupted due to a problem such as a malfunctioning input device (BACKUP). Subsequently, if the input audio is restored, the unit can automatically return to the original circuit.

The backup circuit can be specified in two levels.

Dante In (1-4) is the primary (main circuit), Dante In (13-16) is used as Second (2nd SOURCE), and Analog In (1-4) is used as Third (3rd SOURCE). The channel combinations are fixed.

Primary	2nd SOURCE	3rd SOURCE
Dante IN 1	Dante IN 13	Analog IN 1
Dante IN 2	Dante IN 14	Analog IN 2
Dante IN 3	Dante IN 15	Analog IN 3
Dante IN 4	Dante IN 16	Analog IN 4

• Override mode

If audio input is detected from Dante input (13–16) jacks or from the analog input jacks, the detected signal will automatically interrupt (OVERRIDE) the audio of the normally-used Dante inputs (1–4). This allows a high-priority emergency broadcast or an in-building announcement to be broadcast as an interrupt.

■ COMMON page



① MODE (Redundant Mode)

This specifies the redundant function mode.

BACKUP: The input signal from Dante 1-4 is the primary (main circuit), and when the input from Dante 1-4 is interrupted, the unit automatically switches to the audio from Dante 13-16 or the analog input jacks.

OVERRIDE: The input signal from Dante 1-4 is the main circuit, and automatic switching occurs only when high-priority audio is detected.

② AUTO RETURN

For BACKUP mode:

If this is ON, the input source returns to the main circuit when the main circuit recovers.

For OVERRIDE mode:

If this is ON, the input source returns to the main circuit when the audio from Dante 13–16 or the analog input jacks falls below the threshold value.

■ Dante 1-4 page

```
Dante1>2nd SOURCE
① ON/OFF OFF
② OVR THRESH 0.0dBFS
③ OVR RTN DLY 10sec
```

The backup circuit can be specified in two levels. The channel combinations are fixed.

① ON/OFF

This specifies for each level whether the backup circuit is enabled (ON) or disabled (OFF).

② OVR THRESH (OVERRIDE THRESHOLD)

For OVERRIDE mode, this specifies for each channel the input level threshold value at which the presence or absence of an interrupting input signal is determined.

③ OVR RTN DLY (OVERRIDE RETURN DELAY)

For OVERRIDE mode when AUTO RETURN is ON, this specifies the time from when the interrupting signal input ends until the unit switches back to the main circuit.

7.5. LOAD MONITORING

This constantly monitoring the impedance of the connected speaker, and displays an alert message if an abnormal value is shown. You can check the impedance in the LOAD MONITORING page of the HOME screen.

NOTE

- Load monitoring does not operate in the following cases
 - For a high-impedance connection
 - When the amp is in standby mode
 - When the channel is in the Channel Sleep ON or Auto Sleep On state

SETUP>LOAD MONITOR A	
①	ON/OFF OFF
②	OSC ON/OFF OFF
③	OSC LEVEL 0.0Vrms
④	DETECT. FREQ. 20.0kHz
⑤	HIGH THRESH 50.0Ω
⑥	LOW THRESH 0.0Ω

① ON/OFF

If this is ON, the speaker's impedance is detected.

② OSC ON/OFF

If this is ON, an audio signal is output for detection.

NOTE

- Turn this OFF if a signal for detection is being sent from a device (e.g., mixer) connected before this unit.
- If ① is OFF, a signal for detection is not output even if OSC is ON.

③ OSC LEVEL

This specifies the level of the audio signal for detection.

NOTE

- Gradually raise the OSC LEVEL and check that the impedance value is shown in the HOME screen. However depending on the characteristics of the speaker, there might be cases in which the impedance cannot be detected even if the level is raised to the maximum.
- If you jumped from the HOME screen's LOAD MONITORING page directly to this LOAD MONITORING screen, you can move between them at a touch by alternately pressing the [↶] (back) key and the main knob.

④ DETECT. FREQ. (DETECTION FREQ.)

This specifies the frequency of the audio signal for detection.

 NOTE

- Adjust the frequency, and check that the impedance value is shown in the HOME screen. However depending on the characteristics of the connected speaker, there might be cases in which the impedance cannot be detected even if the frequency is changed. Also, if the frequency is lowered too far, it might be heard as an audible sound; in this case, raise the frequency.

⑤ HIGH THRESH (HIGH THRESHOLD)

This specifies the upper limit of impedance that is considered normal.

⑥ LOW THRESH (LOW THRESHOLD)

This specifies the lower limit of impedance that is considered normal.

7.6. POWER SUPPLY



① PwON DFLT (POWER ON DEFAULT)

When power is applied to the unit, this selects whether the unit starts up in standby mode (STANDBY) or in the same state (POWER ON or STANDBY) as when the power was last disconnected (PREVIOUS).

② PwON DELAY (POWER ON DELAY)

Specifies the time until the amp's power supply starts when switching from STANDBY to POWER ON. In cases such as when multiple amps start up simultaneously, you can set this to provide a time lag so that circuit breakers are not tripped.

 NOTE

- If the power is switched from the front panel, switching happens immediately, regardless of this setting.

7.7. GPI

7.7.1. About GPI

For details on connection methods and examples of use, refer to "Connections using the [GPI IN / OUT] connectors."

In this screen you can assign functions to the GPI IN (PORT 1–6) and GPI OUT (PORT 1–4). The following functions can be assigned.

GPI IN



FUNCTION	Content
NO ASSIGN	—
AMP START	Start the amp
CHANNEL MUTE	Turn mute on/off for the specified channel
CHANNEL SLEEP	Sleep the amp of the specified channel
STANDBY	Switch between ON/Standby
PRESET RECALL	Recall the preset of the specified number
VOLUME +	Raise the volume 1 dB at a time
VOLUME -	Lower the volume 1 dB at a time

GPI OUT

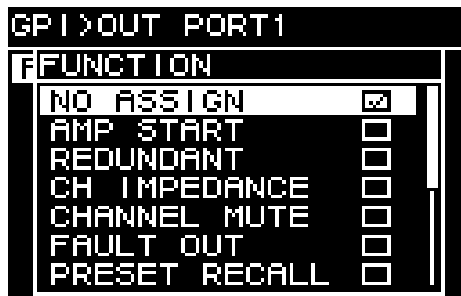

FUNCTION	Content
NO ASSIGN	—
AMP START	The amp is running
REDUNDANT	Output when the Input Source status of one of the channels is other than primary
CH IMPEDANCE	Output when the detected impedance of all specified channels is normal (within the specified upper/lower range)
CHANNEL MUTE	One of the specified channels is muted
FAULT OUT	One of the specified channels is in the Fault state
PRESET RECALL	The preset of the specified number is recalled

8. PROCESSING screen

8.1. INPUT ALIGNMENT

Here you can compensate for differences in level and delay between input channels.

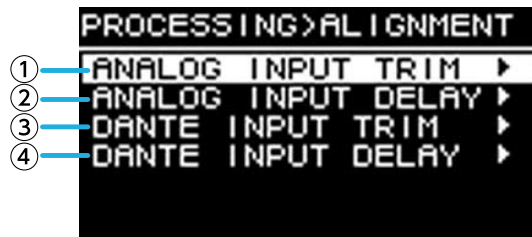

① DANTE INPUT TRIM

This finely adjusts the gain of the specified Dante input channel in 0.1 dB units.

② DANTE INPUT DELAY

This finely adjusts the delay of the specified Dante input channel in 0.01 ms units.

③ ANALOG INPUT TRIM

This finely adjusts the gain of the specified analog input channel in 0.1 dB units.

④ ANALOG INPUT DELAY

This finely adjusts the delay of the specified analog input channel in 0.01 ms units.

8.2. INPUT

Here you can specify the input level from the Dante inputs (1–16) and the analog input jacks.

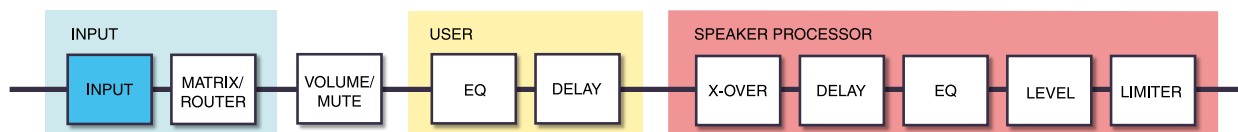
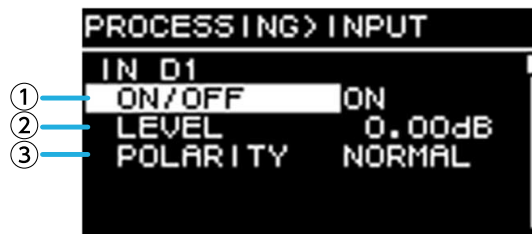

① ON/OFF

This turns the channel on/off.

② LEVEL

This sets the input level.

③ POLARITY

The phrase is normal if "NORMAL" is selected, and inverted if "INVERTED" is selected.

8.3. MATRIX

Here you can edit the level and on/off status of the matrix.

- **MIXER**

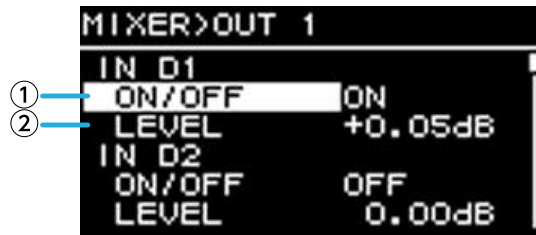

① **ON/OFF**

This turns on/off the send from the input channel to the matrix.

② **LEVEL**

This specifies the volume of the send from the input channel to the matrix.

- **OUTPUT**

Here you can edit the matrix output level and on/off status.

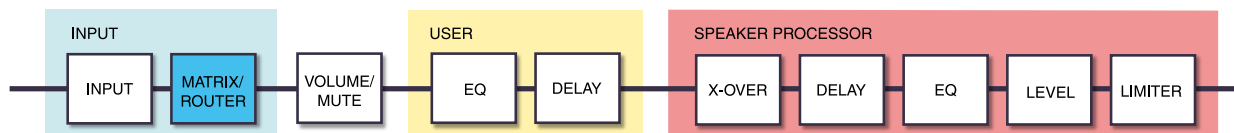
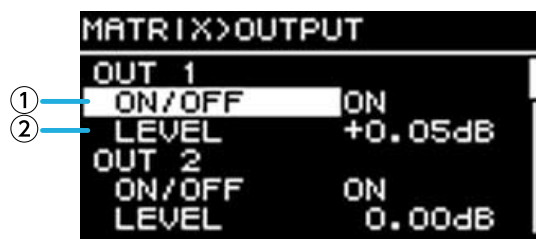

① **ON/OFF**

This turns the channel on/off.

② **LEVEL**

This specifies the matrix output level.

8.4. ROUTER

In this screen, the sound assigned in the preceding MATRIX is distributed to the four amp channels.

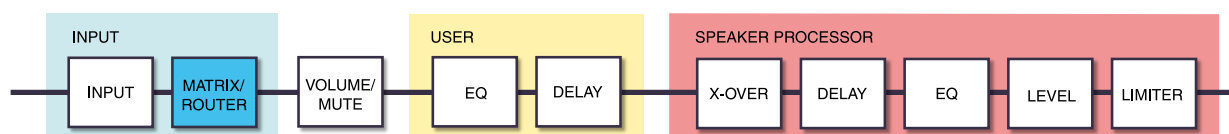

① ROUTING

This selects an input channel (ch1–4) and assigns it to an amp A–D.

8.5. USER EQ/DELAY

8.5.1. USER EQ

Here you can edit the parameters of the 16-band PEQ.

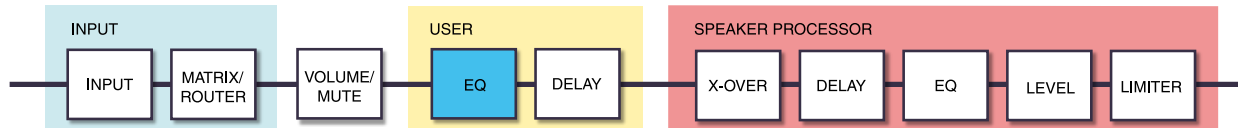
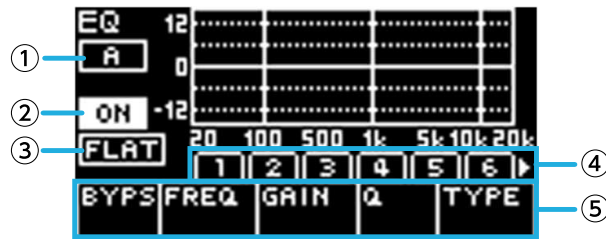

① ON/OFF

This turns the 16-band EQ on/off. If this is off, the EQ response display shows only an outline.

② FLAT

This sets the gain of all bands to 0 dB.

③ Bands 1–16

Here you can select the band whose parameters are shown. When you press the main knob on the selected band, the cursor moves to the parameter display.

④ Parameter display

This shows the parameters of each band. When you move the cursor to the parameter name and press the main knob, you'll be able to set the parameter value. If you press the [↶] (back) key, the cursor returns to the parameter name. When you once again press the [↶] (back) key, you return to the band selection.

8.5.2. USER DELAY

Here you can specify a delay time to compensate for the distance between speakers.

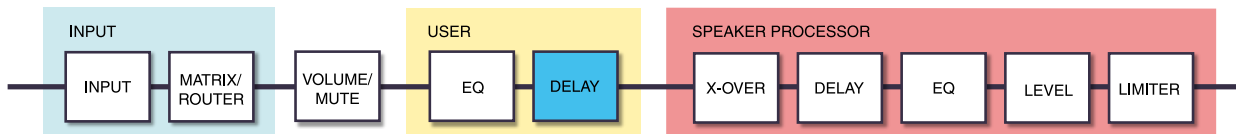
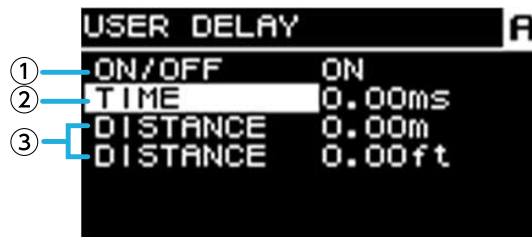

① ON/OFF

This turns the delay on/off.

② TIME [ms]

This specifies the delay time in millisecond units.

③ DISTANCE

This indicates the delay time as a distance (units of meters and feet).

NOTE

- The three delay time indications change in tandem.

8.6. SPEAKER PROCESSOR

8.6.1. SP LIBRARY

Here you can recall optimal settings for the speakers that are connected.

8.6.2. Recalling a speaker preset

1. Press a channel select key to select the recall-destination channel.

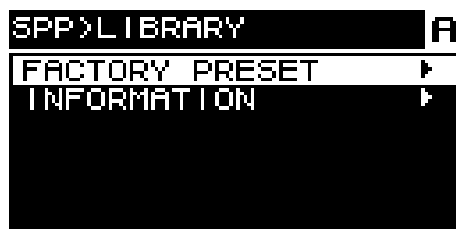

2. Select the series of speaker.

```

SPP>SERIES A
<FLAT> ▶
<GENERIC> ▶
CZR ▶
CXS XLF ▶
CZR ▶
Installation ▶

```

 NOTE

- When you select a speaker, the filter, speaker impedance, and limiter threshold value are specified automatically. If the connected speaker is not one of the choices, select "GENERIC."

3. From the speaker series selected in the SPP>SERIES screen, select the model of speaker that is connected.

```

CZR>MODEL A
CZR10
CZR12
CZR15

```

4. Select the preset that is appropriate for the way in which the speaker is being used.

```

CZR15>PRESET A
CZR15_Pq_FIR
CZR15_Pq_sub_FIR
CZR15_Pq_moni
CZR15_bi_FIR_L
CZR15_bi_FIR_H
CZR15_bi_sub_FIR_L

```

A screen for confirming the recall appears.

```

CZR15>PRESET A
[SP PRESET RECALL
CZR15_Pq_FIR
CANCEL OK

```

- To recall: Turn the main knob to select OK, and then press to confirm.
- To cancel: Turn the main knob to select CANCEL, and then press to confirm.

8.6.3. INFORMATION

Here you can view information about the selected speaker preset (the speaker model name, and the mode and type of FIR filter).

```
SPP> INFORMATION A
MODEL C2R15
SPP C2R15_PaL FIR
FIR EQ
TYPE C2R15_PaL FIR
```

8.6.4. X-OVER

This applies a high-pass filter and a low-pass filter to the signal, allowing only a specific frequency region to pass.

```
SPP> X-OVER A
① HPF TYPE 48dB BUT
② HPF FREQ 20.0HZ
③ HPF Gc
④ LPF TYPE THRU
⑤ LPF FREQ 20.0kHz
⑥ LPF Gc
```

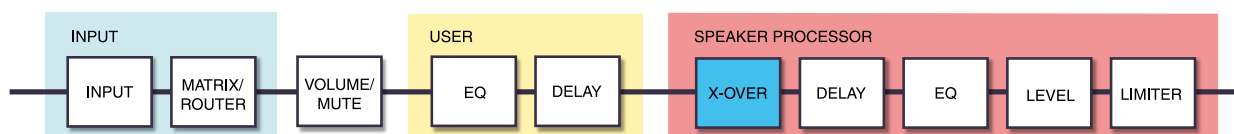

① HPF TYPE

This selects the attenuation per octave and filter type of the high-pass filter. If [Thru] is selected, no filter is applied.

② HPF FREQ

This specifies the cutoff frequency of the high-pass filter.

③ HPF Gc

When AdjGc is selected as the Type, this specifies the gain of the cutoff frequency.

④ LPF TYPE

This selects the attenuation per octave and filter type of the low-pass filter. If [THRU] is selected, no filter is applied.

⑤ LPF FREQ

This specifies the cutoff frequency of the low-pass filter.

⑥ LPF Gc

When AdjGc is selected as the TYPE, this specifies the gain of the cutoff frequency.

AdjGc (Adjustable Gain Control)

This adjusts Gc (gain at the cutoff frequency) in the range of -6 – +6 dB. A setting of -3 dB is a Butterworth filter, and a setting of -6 dB is a Linkwitz-Riley filter. If this is selected, the Gc knob is shown.

But (Butterworth)

This is the most common response. The passband is flat, and the gain at the cutoff frequency is -3 dB.

Bessl (Bessel)

This provides a curve that emphasizes phase response, and although the attenuation is more gradual than Butterworth, there is no waveform distortion when a square wave is sent through.

L-R (Linkwitz-Riley)

The filter order is a power of two, and the response is such that when the output of the LPF and HPF are voltage-summed, the gain of all frequency bands is 0 dB. The passband is flat, but the gain at the cutoff frequency is -6 dB.

⑦ POLARITY

This selects the polarity. If you select INVERTED, a Φ symbol is shown in the HOME screen.

8.6.5. DELAY

Here you can specify the delay time for the speaker processor's speaker delay.

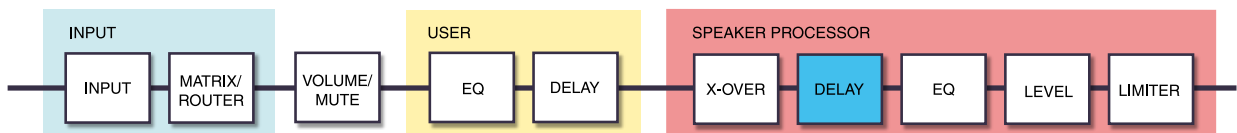
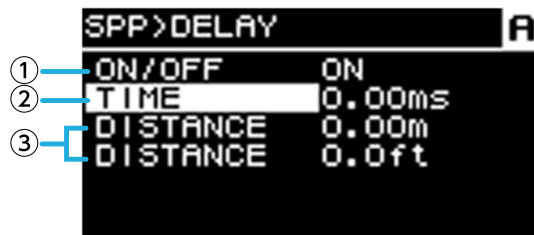

① ON/OFF

This turns the delay on/off.

② TIME [ms]

This specifies the delay time in millisecond units.

③ DISTANCE

This indicates the delay time as a distance (units of meters and feet) linked with TIME.

8.6.6. EQ

Here you can edit the parameters of the speaker processor's 16-band PEQ.

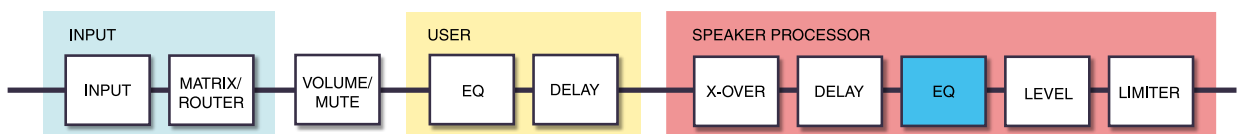
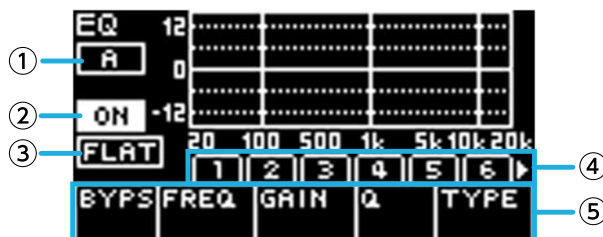

① Channel indication

This indicates the channel to which the EQ applies. Use the channel select keys of the panel to select the channel

that is shown.

② ON/OFF

This turns the 16-band PEQ on/off. If this is off, the EQ response display shows only an outline.

③ FLAT

This sets the gain of all bands to 0 dB.

④ Bands 1–16

Here you can select the band whose parameters are shown. When you press the main knob on the selected band, the cursor moves to the parameter display.

⑤ Parameter display

This shows the parameters of each band. When you move the cursor to the parameter name and press the main knob, you'll be able to set the parameter value. If you press the [↶] (back) key, the cursor returns to the parameter name. When you once again press the [↶] back key, the cursor returns to the band.

8.6.7. OUTPUT

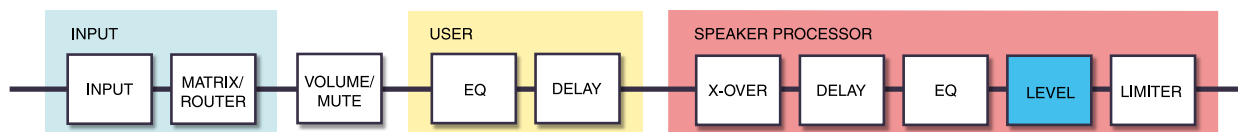

① LEVEL

This adjusts the level difference between speakers in steps of 0.05 dB.

8.6.8. PEAK LIMITER

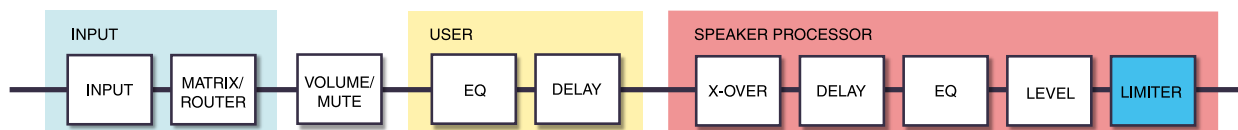

① ON/OFF

This turns the peak limiter on/off.

② THRESHOLD

This specifies the threshold value at which the peak limiter applies, in terms of output power (W). The voltage (V) is also shown linked with this.

③ ATTACK

This specifies the attack speed of the peak limiter, in msec units.

④ RELEASE

This specifies the release speed of the peak limiter, in msec units.

⑤ IMPEDANCE (Ω /UNIT)

This specifies the impedance of the connected speaker in the range of 4.0Ω – 36.0Ω . The voltage (V) is automatically set in linkage with this.

Even when connecting multiple speakers in parallel, specify this as the impedance of one unit.

8.6.9. RMS LIMITER

SPP>RMS LIMITER		A
①	ON/OFF	OFF
②	THRESH(W)	5000W
②	THRESH(V)	200.0V
③	ATTACK	0.2s
④	RELEASE	0.5s
⑤	IMPEDANCE	8.0 Ω

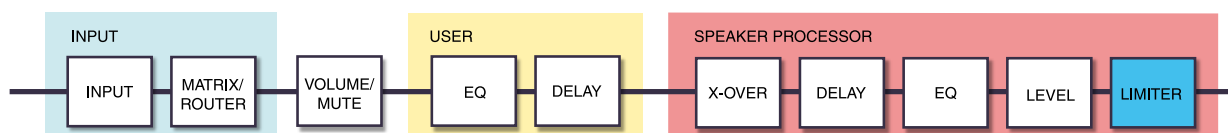
**① ON/OFF**

This turns the RMS limiter on/off.

② THRESHOLD

This specifies the threshold value at which the RMS limiter applies, in terms of output power (W). The voltage (V) is also shown linked with this.

③ ATTACK

This specifies the attack speed of the RMS limiter, in sec units.

④ RELEASE

This specifies the release speed of the RMS limiter, in sec units.

⑤ IMPEDANCE (Ω /UNIT)

This specifies the impedance of the connected speaker in the range of 4.0Ω – 36.0Ω . The voltage (V) is automatically set in linkage with this.

Even when connecting multiple speakers in parallel, specify this as the impedance of one unit.

9. NETWORK screen

Here you can make settings for network audio (Dante) and remote control, and view the status of the network.

9.1. DEVICE



① UNIT ID

This specifies the ID that individually distinguishes PC-D/DI series units on the Dante network. The specified UNIT ID is applied after this unit is restarted. If more than one unit of the same model exists in the same network, ensure that the ID does not conflict.

NOTE

- The range of this setting is 01–FE (hexadecimal).

Turn the main knob to select the character that you want to input, and then press the main knob to confirm the character. In the restart confirmation screen, select YES. The setting is applied after the restart.

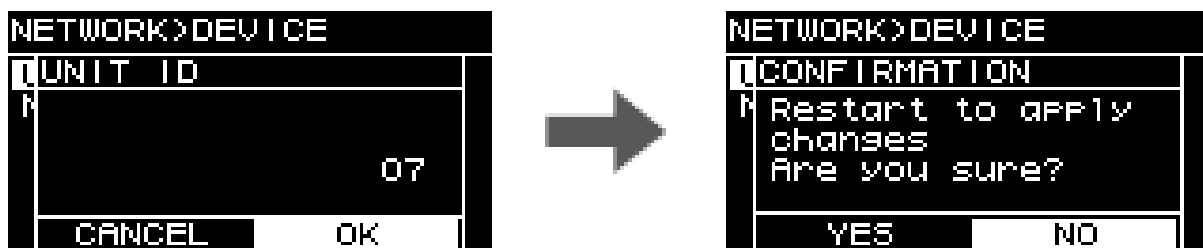

The specified UNIT ID is shown in the HOME screen.

② NAME

This specifies the device name of this unit. If you assign an easily-recognizable device name, it will be easier to distinguish it in Provisionaire Amp Editor.

NOTE

- A name of up to 32 characters can be entered.
- The following characters can be entered.
 ABCDEFGHIJKLMNOPQRSTUVWXYZ
 abcdefghijklmnopqrstuvwxyz
 0123456789
 !"#%&'()*+,-./:;<=>?@[^_`{|}
- Characters other than the above that were assigned in Provisionaire Amp Editor are displayed as "?".

9.2. Dante

Here you can make settings related to the Dante network. The status of the Dante network can be checked here.

```

NETWORK>Dante
① SYNC          NORMAL
② Fs           96kHz
③ LATENCY      0.5ms
④ ENCODING     24bit
⑤ SECONDARY    REDUNDANT
⑥ LABEL
⑦ LOCK         UNLOCKED
⑧ DDM
STATE          UNMANAGED
LOCAL          READ WRITE
  
```

① SYNC

This indicates "NORMAL" if the network is operating normally, or "NOT READY" if the Dante module is being prepared. Otherwise, the ID of the SYNC message is shown.

② Fs (DANTE Fs)

This specifies the sampling frequency of Dante input/output. Choose from 44.1 kHz, 48 kHz, 88.2 kHz, and 96 kHz.

NOTE

- Set this to match the Fs of the unit that patches the audio. You can't patch if the Fs differs between units.
If you change the Fs while patched, the audio is interrupted.

③ LATENCY

This specifies the latency of the signal that the Dante network transmits and receives (the Dante latency).

Choose from 0.25 ms, 0.5 ms, 1 ms, 2 ms, and 5 ms.

The appropriate latency setting for the signal that is transmitted and received via the Dante network will differ depending on the type of connections and the scale. Here we explain how to consider the latency setting in view of the state of connections between the Dante-enabled devices that are connected to the PC-D/DI series unit.

■ The relationship between switches and the number of hops

The latency setting for the Dante network depends on the number of hops in that network.

The number of hops indicates the number of switches that exist between the master and the most distant connected device when considered as a series connection. A switch is contained in each switching hub as well as in each PC-D/DI series unit or I/O device. This number of hops provides a guideline for the latency that you should specify.

Typical latency settings for various numbers of hops are given below.

Number of hops	Latency (ms)
Up to 3	0.25
Up to 5	0.5
Up to 10	1.0
Up to 20	2.0

Number of hops	Latency (ms)
21 or more (or if problems occur)	5.0

 NOTE

- If two patched devices have different latency settings, the slower setting applies.
- Depending on the state of the network, it might be necessary to increase the latency even if the number of hops is low.
- If a problem occurs, choose 5.0 ms to check whether the latency setting is the cause of the problem.

④ ENCODING (display only)

⑤ SECONDARY (SECONDARY PORT)

This selects whether the two Dante ports are used for a redundant connection (REDUNDANT) or a daisy-chain connection (DAISY CHAIN).

⑥ LABEL

This shows the Dante device label.

⑦ LOCK

This shows the Dante Device Lock status. This setting is made by the Dante Controller.

This indicates LOCKED if the setting is locked, or UNLOCKED if the setting is unlocked. If this is locked, Dante-related settings cannot be changed.

⑧ DDM (Dante Domain Manager)

If there is a DDM server on the network or if joined to a domain, this indicates the status.

- STATE: Indicates the state of domain connection.
 - DOMAIN Joined to a domain
 - DISCONNECTED Joined to a domain but not connected to the DDM server
 - UNMANAGED Not joined to a domain
- LOCAL: Indicates the access status of the Dante settings (including DANTE PATCH) of the unit currently being operated.
 - READ WRITE Editable
 - READ ONLY Not editable

9.3. CONTROL

Here you can make settings related to remote control.

```

NETWORK>CONTROL
① IP SET.  DHCP
② IP ADR.  192.168.000.101
③ NETMASK  255.255.255.000
④ GATEWAY  192.168.000.001
⑤ MAC      006037123456

```

① IP SET. (IP SETTINGS)

This selects how the IP address is set.

- UNIT ID: 192.168.0. ### is set (### = UNIT ID).
- DHCP: The IP address assigned by the DHCP server is set. The IP address, NETMASK, and GATEWAY are obtained automatically. If there is no DHCP server on the network, the unit operates using a link local address (169.254.xxx.xxx).
- STATIC IP: The IP address is specified manually.

② IP ADR.

This shows the IP address. If STATIC IP is selected in IP SET., specify the IP address here.

③ NETMASK

This shows the subnet mask. If STATIC IP is selected in IP SET., specify the subnet mask address here.

④ GATEWAY

This shows the default gateway.

Depending on the setting of IP SET.(①), this is shown as follows.

- UNIT ID: Default gateway is disabled
- STATIC IP: Default gateway is set manually

⑤ MAC

This shows the MAC address. This address is only displayed, and cannot be changed.

10. UTILITY screen

Here you can make various settings for the unit.

10.1. PANEL SETUP

Here you can make display settings.



① BRIGHTNESS

This specifies the brightness of the display backlight.
It can be specified in ten steps 1–10.

② CONTRAST

This specifies the display contrast.
It can be specified in 16 steps 1–16. As appropriate for the surrounding conditions, set this so that the display can be viewed easily. If the value is too large, the display will be difficult to read directly from the front.

③ AUTO DIMMER (AUTO PANEL DIMMER)

This specifies the time after which the panel is dimmed.

④ DIMMER (DIMMER BRIGHTNESS)

This specifies the brightness of the display backlight as a percentage (%) when it is dimmed.

⑤ AUTO LOCK (AUTO PANEL LOCK)

This specifies the time after which the panel is locked.

⑥ LOCK MODE (PANEL LOCK MODE)

This specifies the panel lock setting.

- PARTIAL: Operations related to the display are locked. Volume and mute settings are possible.
- ALL: No operation is possible other than unlocking the panel.

⑦ ENABLE PIN (ENABLE PANEL UNLOCK PIN)

This enables/disables a PIN code used for panel lock.

⑧ UNLOCK PIN (PANEL UNLOCK PIN)

This specifies a panel lock PIN code (any four-digit number).
If you specify a PIN code, the PIN code must be entered in order to unlock the panel.

 NOTE

- If you forget the PIN code, you can clear it by initializing the unit. Refer to "[Initialization if you have forgotten the PIN code.](#)"

10.2. Specifying the PIN code

1. Access the PIN code entry screen.

Choose MENU screen → UTILITY → PANEL SETUP → UNLOCK PIN.
The cursor is at the highest digit of the PIN code.



2. Input the current PIN code.

Turn the main knob to select a numeral, and press the main knob to confirm.
When you confirm, the cursor moves to the right.

 NOTE

- The factory-set PIN code is 0000.

3. Using the same operation, confirm the four-digit code.

 NOTE

- If you want to correct the PIN code during this entry process, press the [↶] (back) key and use the main knob to select the digit that you want to correct.

4. Press the main knob to select OK.

A screen for entering the new PIN code appears.

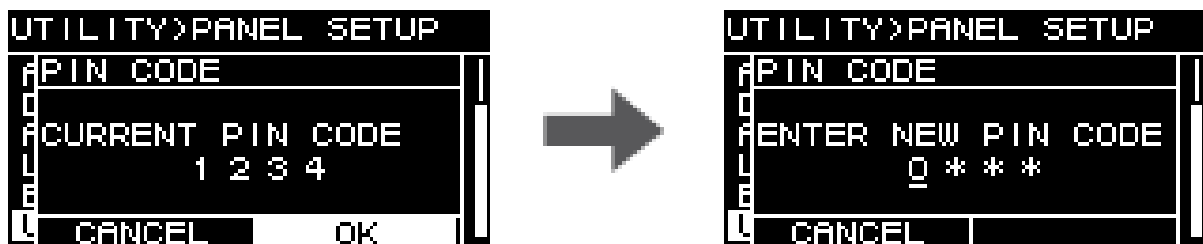

5. Enter the new PIN code, and press the main knob to select OK.
The PIN code is confirmed.

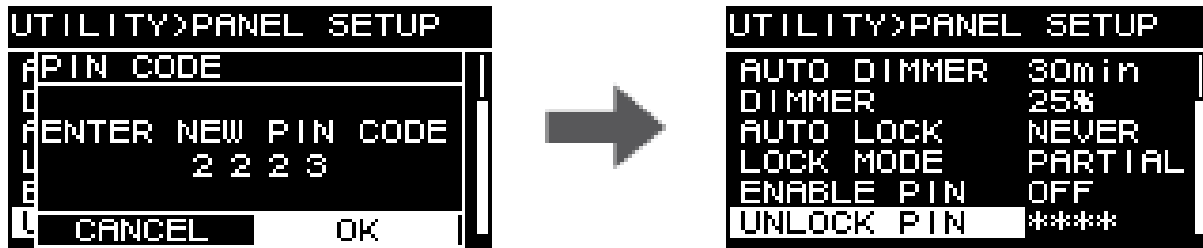

10.3. To defeat panel lock

If you operate the panel while the panel is locked, the following message appears in the screen.

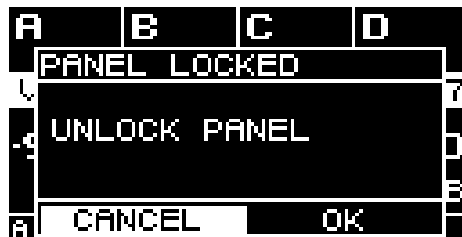

Turn the main knob to select OK, and press the main knob to confirm.

10.4. HOME SCREEN



① METER

This specifies the position of the meter that is shown in the HOME screen.

INPUT: Immediately before the volume. This allows you to monitor the input signal even if the volume is turned down.

OUTPUT: Immediately before the speaker output jack. This allows you to monitor the signal that is actually being output from the speaker output jack.

10.5. DEVICE INFORMATION

This screen shows the state of this unit and information specific to it.



① THERMAL PSU

This shows the temperature of the power supply section in three levels. If the maximum indication is reached, a limiter is applied.

② THERMAL AMP

This shows the temperature of the amp section in five levels. A limiter is applied according to the temperature.

③ BATTERY

This shows the state of the internal battery in three levels.

NOTE

- When the battery runs down, this indicates LOW or NO. If this occurs, immediately contact your dealer listed at the end of the quick guide (separate document) to have the backup battery replaced.

④ RUN TIME

This indicates the total operating time of this unit.

⑤ VERSION

- FIRMWARE: Indicates the firmware version.
- Dante: Indicates three Dante-related versions.
- SERIAL: Indicates the serial number of this unit.

10.6. CLOCK



① DATE

This shows and sets the date of the internal clock.

② TIME

This shows and sets the time of the internal clock.

NOTE

- You can use Provisionaire Amp Editor to apply the computer's time to this unit. For details, refer to the Provisionaire Amp Editor setup guide.

10.7. INITIALIZE

This shows in the display how to initialize data within the amp.

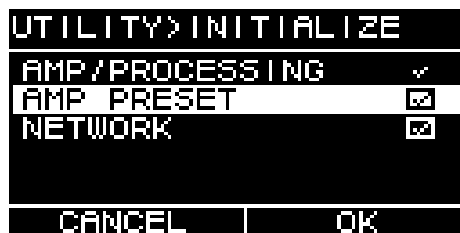

NOTE

- For details on the initialization method, refer to "[Returning to the factory settings \(Initialization\)](#)".

10.8. REBOOT

If you have modified multiple settings that require a reboot, use this to reboot once for all of these changes. A message like the following appears in the screen.

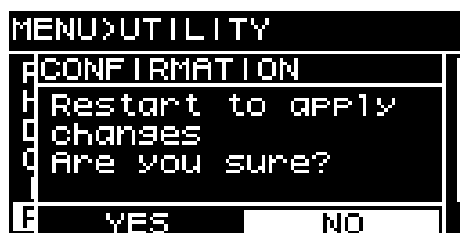

- To reboot: Turn the main knob to select YES, and then press to confirm.
- To cancel: Turn the main knob to select NO, and then press to confirm.

10.9. LOG

Here you can view alerts and information generated by this unit. System log data is helpful in identifying the cause of a problem or malfunction.

NOTE

- Approximately 800 items of log data can be saved in internal memory. If this number is exceeded, the oldest log items are successively deleted as new log items are saved.



① LOG LIST

This shows the entire operating log that is stored internally.

Log events are shown in the order in which they occurred.

Time information is shown in the format "YYMMDD HH:MM:SS▶N." This means that in the year YY, month MM, and day DD, at HH hours MM minutes and SS seconds, NN events occurred.

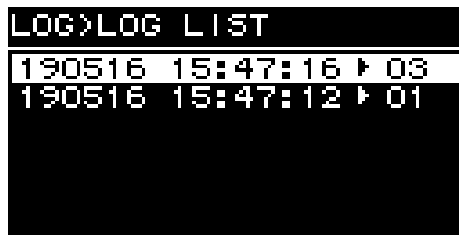

Turn the main knob to select an event, and then press the main knob to access the DETAIL VIEW screen. For details on the messages, refer to "[Message list.](#)"

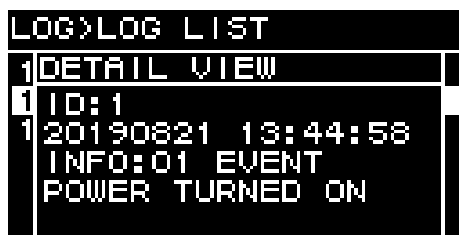

NOTE

- When this screen is shown, turning the main knob moves to the previous or next log data.

② LOG CLEAR

When you want to clear the log data display, such as during maintenance, select YES in the following confirmation screen to clear the log.

The log data saved in internal memory is preserved.

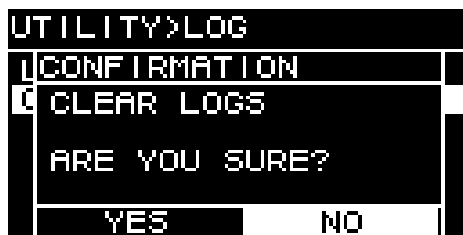

11. About Dante

■ An overview of Dante

In addition to analog input and output, the PC-D/DI series uses Dante as the protocol for conveying digital audio signals. Dante is a network audio protocol developed by the Audinate Corporation. In a network environment that supports gigabit Ethernet, this protocol can transfer multiple audio signals of differing sampling frequencies and bit rates as well as device control signals across the same network.

For details on Dante, refer to the Audinate Corporation website.

<http://www.audinate.com/>

The Yamaha pro audio website also provides various information about Dante.

<http://www.yamahaproaudio.com/>



NOTE

- Do not use the EEE function (*) of a network switch inside a Dante network. Power consumption settings are automatically adjusted between switches that support the EEE function, but some switches do not correctly adjust these mutual settings correctly. This means that in certain unfavorable cases within the Dante network, the EEE function of a switch might be enabled, impairing the clock synchronization capability and causing audio to be interrupted. For this reason, please note the following points.
 - If using a managed switch, turn off the EEE function of all ports that use Dante. Do not use a switch that does not allow you to turn off the EEE function.
 - If using an unmanaged switch, do not use a switch that supports the EEE function. Such switches cannot turn off the EEE function.
- The EEE (Energy Efficient Ethernet) function is technology that reduces power consumption of an Ethernet device when network traffic is sparse. It is also called "green Ethernet" or IEEE802.3az.

11.1. Connection methods

There are two methods of connecting a PC-D/DI series unit to a Dante network, and you can use a combination of these methods.

11.1.1. Redundant connection

A redundant connection allows you to construct a system that is more resistant to network malfunctions than a daisy-chained network. A redundant connection consists of two circuits, a primary and a secondary. Communication normally occurs on the primary circuit, but automatically switches to the secondary circuit if a problem occurs, such as the primary circuit being disconnected.

NOTE

- No more than 80 Dante units should be connected to the same network. If you need to connect more than 80 units, divide them into subnets.

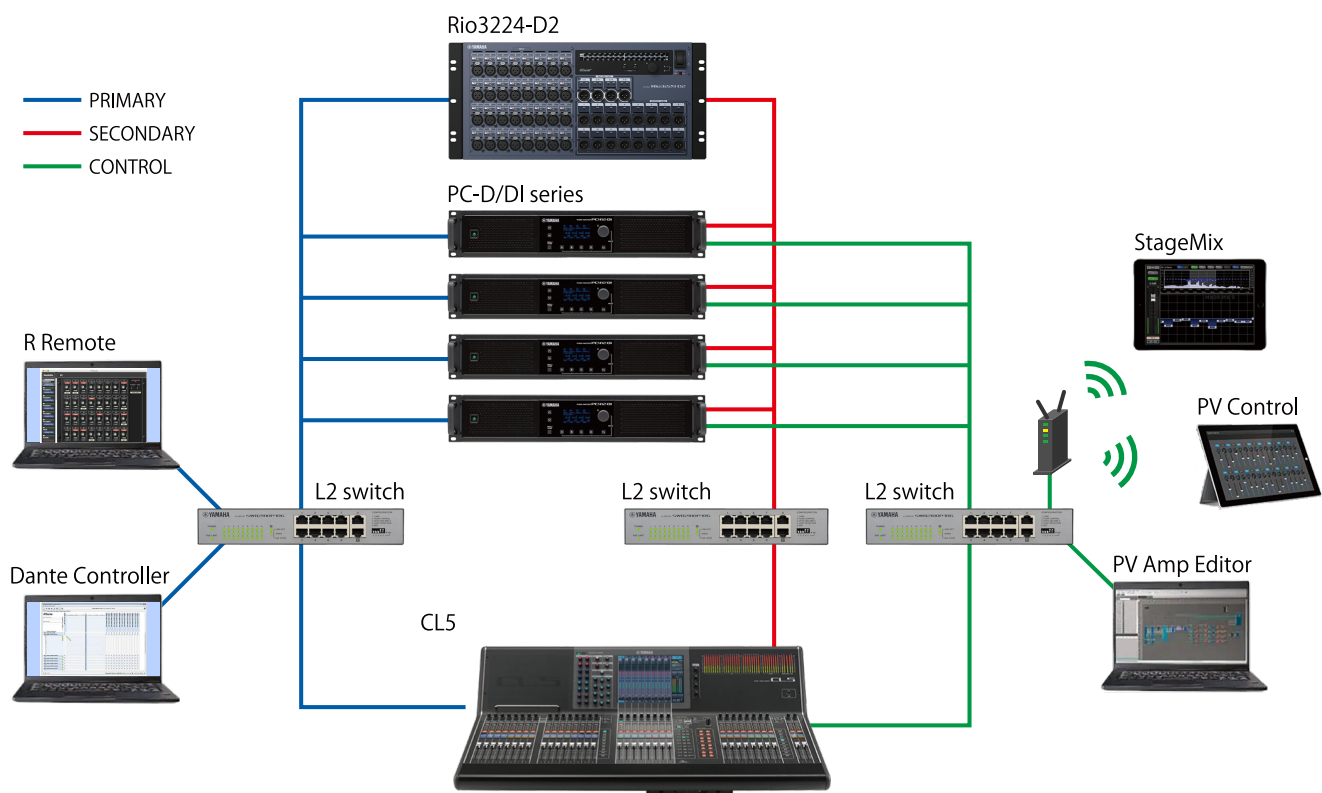

NOTE

- If you want to operate Dante Controller and PV amp editor on the same computer, connect them using separate network interface cards.

11.1.2. Daisy-chain connection

Daisy-chain is the connection method in which units are connected from one unit to the next like the links of a chain. Construction of the network is simple, and a network switch is not required.

Connecting numerous units will increase the communication delay with the last unit, so it will be necessary to increase the latency to prevent interruptions of sound on the Dante network. If a problem occurs with the system, such as a broken cable, the network will be broken at that point, and communication with subsequent units will be impossible.

If the latency is at the default setting (0.5 msec), no more than five Dante units should be in one daisy-chain connection. If six or more units are connected, the communication delay within the network will be greater, possibly causing interruptions in the sound. To avoid this, you can either increase the Dante LATENCY setting, or use an L2 switch (gigabit Ethernet compatible) to divide the network.

NOTE

- The three ports Dante [PRIMARY]/[SECONDARY] and NETWORK are connected by an internal switch, so you can use any port for Dante audio or computer connection.
- Do not connect more than one port to the same external switch, since this would cause a network loop.

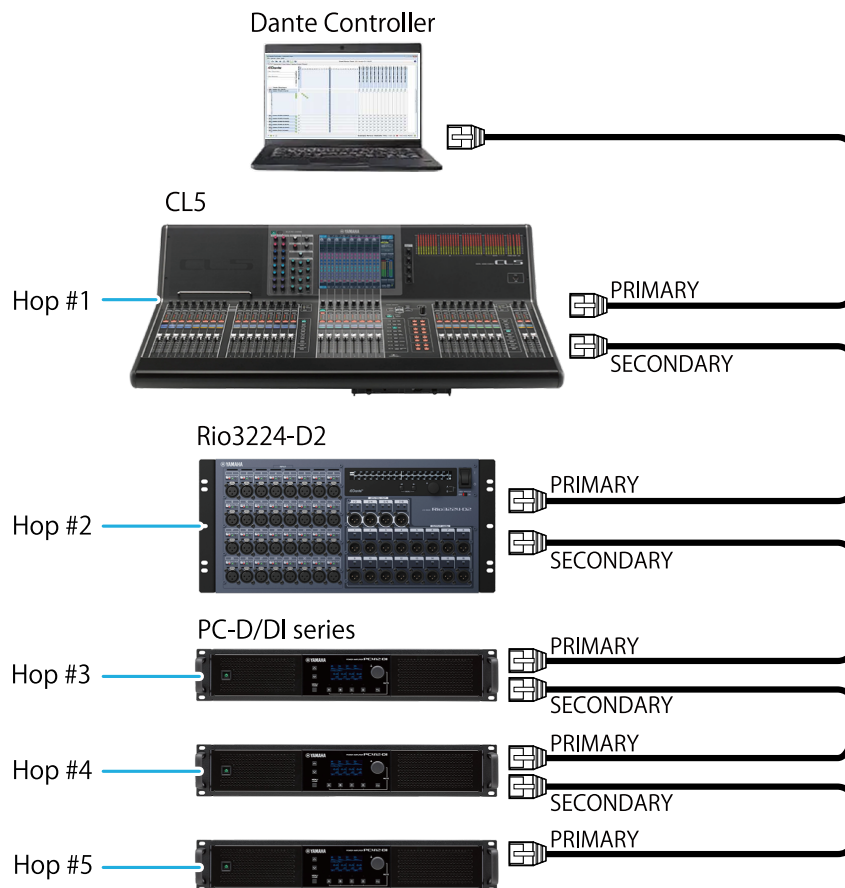

11.2. Dante settings

If you are using this PC-D/DI series unit connected to a Dante network, you'll need to make various Dante-related settings in the DANTE screen.

Dante screen

```

NETWORK>Dante
-----
SYNC          NORMAL
Fs            96kHz
LATENCY       0.5ms
ENCODING      24bit
SECONDARY     REDUNDANT
LABEL
LOCK          UNLOCKED
DDM
STATE        UNMANAGED
LOCAL        READ WRITE

```

For details on each function, refer to "NETWORK screen" – [Dante](#).

11.3. Connections to Dante devices

11.3.1. About Dante Controller

Dante Controller is application software for setting-up a Dante network and for routing the audio. Use Dante Controller if you will be connecting to a Dante device other than a Yamaha digital mixer that supports integration with the PC-D/DI series, or if you want to make more detailed settings.

Download the latest version of Dante Controller from the following website.

<http://www.yamahaproaudio.com/>

The computer on which Dante Controller is installed must have an Ethernet port that supports gigabit Ethernet.

Dante Controller mainly lets you make the following settings.

- Input/output patch settings in the Network View's Routing tab
- Clock master settings in the Network View's Clock Status tab
- Sampling frequency settings in the Device View's Device Config tab

NOTE

- If Dante Device Lock is enabled in Dante Controller, it is not possible to change settings such as Dante-related input/output patching. If you want to change the settings, use Dante Controller to defeat Dante Device Lock.

11.3.2. Dante Controller settings

When you start Dante Controller, the Network View opens first.

In Network View, you can specify the audio routing between the Dante devices. This screen shows all Dante devices on the network. Click the cell [+] at which the transmitting and receiving devices intersect so that all channels are shown, and then specify the audio routing. When a route is established, a green checkmark icon appears.

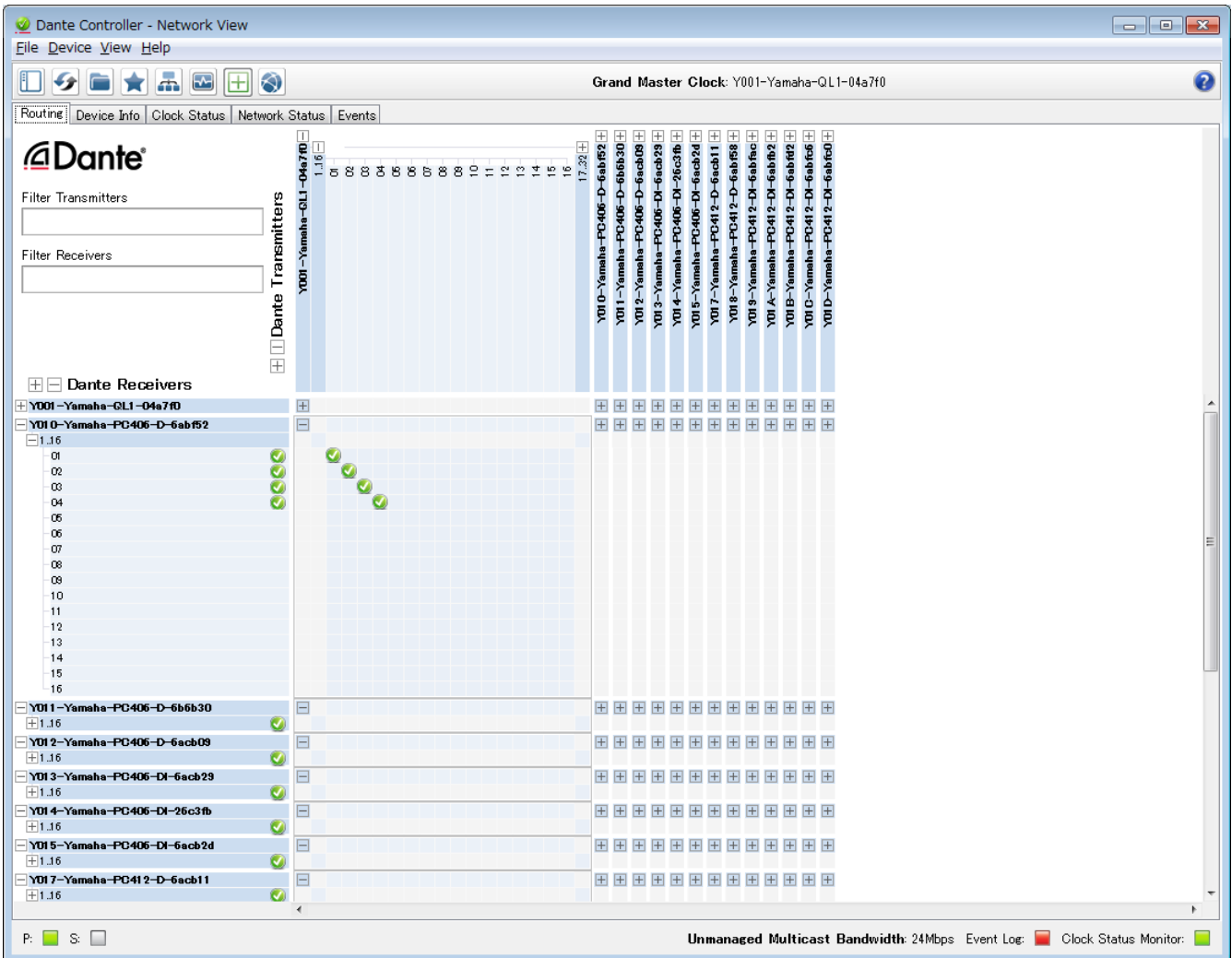

For details, refer to the Dante Controller user manual.

For details regarding the Dante channel to which the output of a transmitting device (e.g., digital mixer) is assigned, refer to the manual of the transmitting device.

12. Returning to the factory settings (initialization)

There are two ways to initialize this product.

12.1. By selecting MENU screen → UTILITY → INITIALIZE

1. In the MENU screen, turn the main knob to select "UTILITY," and press the main knob to confirm. The UTILITY screen appears.

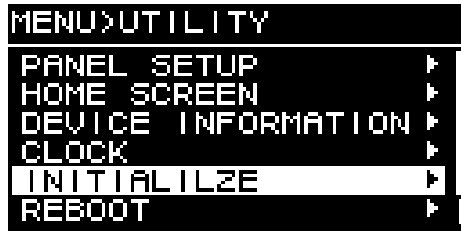

2. In the UTILITY screen, turn the main knob to select "INITIALIZE," and press the main knob to confirm. The INITIALIZE screen appears.

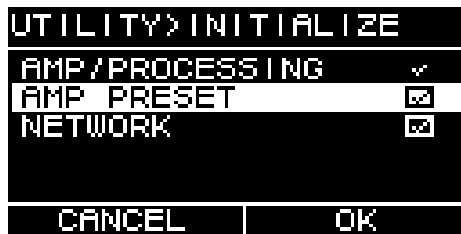

3. Turn the main knob to choose the type of settings that will be initialized (multiple selections are possible), and press the main knob to confirm.

The following table shows what can be initialized.

AMP/PROCESSING	PROCESSING SETUP UTILITY
AMP PRESET	AMP PRESET
NETWORK	IP SETTING DANTE SETTINGS, UNIT ID

NOTE

- AMP/PROCESSING is always initialized.

4. When you have finished making selections, turn the main knob to move to [OK], and press the main knob to confirm.
5. In the confirmation screen, turn the main knob to select "YES," and press the main knob to confirm. When initialization is completed, the unit restarts automatically, and then enters the power-on state.

12.2. Initialization if you have forgotten the PIN code, etc.

If you are unable to select INITIALIZE in the UTILITY screen, for example if you have forgotten the PIN code specified for panel lock, you can initialize using the following method.

1. **Disconnect the unit from the AC outlet.**
2. **While holding down channel select key [A] and the [↶] (back) key, connect the unit to the AC outlet.**
A confirmation screen appears.
3. **Press the main knob to confirm.**

Initialization begins. During initialization, all channel indicators are lit red.

When initialization is completed, all channel indicators are lit green, the unit restarts automatically, and then enters the standby state.

13. Reference

13.1. Installing the handles

Install the included handles as necessary.

1. **Align the handles with the holes on the unit, and install it using the included screws (4 pcs.).**

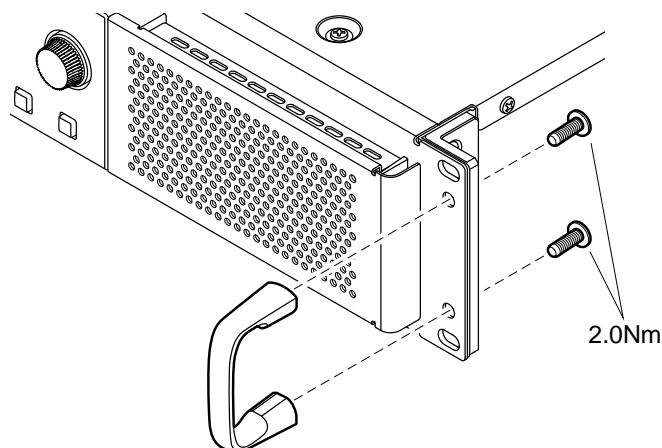

13.2. Cleaning the air filters

To ensure that appropriate cooling air can enter, clean the filter elements as follows if they become clogged.

1. **Make sure that the amplifier is powered-off.**
2. **Disconnect the power cord from the AC outlet.**
3. **Detach the grill.**
4. **Remove the filter element and wash it with water. If the filter element is heavily soiled, use dishwashing liquid.**
5. **Allow the filter element to dry completely.**

Attaching the filter element while it is still wet will cause malfunctions.

Place the filter element on the cooling vent, and attach the grill.

The replacement part numbers for the filter elements are as follows.

- Filter element L: VAS54300
- Filter element R: VAS54400

13.3. Function list

PARAMETERS		CH/BAND/ PORT	MIN/MAX	DEFAULT	AMP PRES ET	FOCUS RECAL L
INPUT ALIGNMENT		TRIM	D1-D16, A1-A4	-6.0 dB to +6.0 dB	0 dB	-
		DELAY		0.00 ms to 12.00 ms	0.00 ms	
INPUT		ON	D1-D16, A1-A4	OFF/ON	ON	●
		LEVEL		$-\infty$ to +10.00 dB	0.0 dB	
		POLARITY		Normal/Inverted	Normal	
MATRIX	MIXER	ON	OUT1-8 > D1-D16, A1-A4	OFF/ON	*Follows Factory Preset A	●
		LEVEL		$-\infty$ to +10.00 dB	0.0 dB	
	OUTPUT	ON	OUT1-8	OFF/ON	ON	●
		LEVEL		$-\infty$ to +10.00 dB	0.0 dB	
ROUTER	ROUTING	-	A-D	CH1-4	*Follows Factory Preset A	●
DEVICE MUTE			A-D	OFF/ON	OFF	-
OUTPUT		VOLUME	A-D	-99.0 dB to 0.0 dB	-99.0 dB	●
		MUTE		OFF/ON	OFF	-
USER	EQ	ON	A-D	OFF/ON	ON	●
		BYPASS	A-D	OFF/ON	OFF	
		FREQ	>BAND1- 16	20.0 Hz to 20.0 kHz	For each band *4	
		GAIN		-18.0 dB to +18.0 dB	0.0 dB	
		Q		63.0~0.1	4.2	
		TYPE		5 types *2	PEQ	
	DELAY	ON	A-D	OFF/ON	ON	●
		TIME		0.0 ms to 1000.00 ms 0.0 mt to 343.59 mt 0.0 ft to 1127.26 ft	0.00 ms 0.00 mt 0.00 ft	
						SP PROCE SSOR
						-
						Volume
						-
						User EQ Delay

PARAMETERS			CH/BAND/ PORT	MIN/MAX	DEFAULT	AMP PRES ET	FOCUS RECAL L
SP PROCESSOR	X-OVER	HPF TYPE	A-D	20 types *1	48 dB BUT	●	SP PROCE SSOR
		HPF FREQ		20.0 Hz to 20.0 kHz	20.0 Hz		
		HPF Gc		-6 dB~+6 dB	-3 dB		
		LPF TYPE		20 types *1	THRU		
		LPF FREQ		20.0 Hz to 20.0 kHz	20.0 kHz		
		LPF Gc		-6 dB~+6 dB	0 dB		
		POLARITY		NORMAL/INVERTED	NORMAL		
	DELAY	ON	A-D	OFF/ON	ON	●	
		TIME		0.0 ms to 200.00 ms 0.0 mt to 66.72 mt 0.0 ft to 225.4 ft	0.00 ms 0.00 mt 0.00 ft		
	EQ	ON	A-D	OFF/ON	ON	●	
		BYPASS	A-D >BAND1- 16	OFF/ON	OFF		
		FREQ		20.0 Hz to 20.0 kHz	For each band *4		
		GAIN		-18.0 dB to +18.0 dB	0.0 dB		
		Q		63.0~0.1	4.2		
		TYPE		5 types *2	PEQ		
	OUTPUT	LEVEL		A-D	-99.0 dB to 0.0 dB	-99.0 dB	●
	PEAK LIMITER	ON	A-D	OFF/ON	ON	●	
		THRESHOLD		10 W - 5000 W 6.3 V to 424.3 V	5000 W 200V		
		ATTACK		0.0 to 120.0 ms	25.0 ms		
		RELEASE		0 to 6000 ms	400 ms		
	RMS LIMITER	ON	A-D	OFF/ON	ON	●	
		THRESHOLD		10 W to 5000 W 6.3 V to 424.3 V	5000 W 200V		
		ATTACK		0.0s to 30.0s	1.0s		
		RELEASE		0.0s to 60.0s	2.0s		
	FIR	MODE	A-D	OFF/X-OVR/EQ	OFF	●	
		TYPE		*24 characters	""		
	SPP INFORMATIO N	PRESET NAME	A-D	*24 characters	""	●	
IMPEDANCE		4.0 to 32.0 Ω		8.0 Ω			

PARAMETERS		CH/BAND/ PORT	MIN/MAX	DEFAULT	AMP PRES ET	FOCUS RECAL L
AMP SETTINGS	BRIDGE		A/B,C/D	OFF/ON	OFF	• SP PROCE SSOR
	MODE *only DI model		-	Lo-Z/70 V/100 V	Lo-Z	-
	HPF(Hi-Z) *only DI model		-	40 Hz/80 Hz	80 Hz	-
	CHANNEL SLEEP		A-D	OFF/ON	ON	-
	SENS./GAIN		-	+4 dBu/+14 dBu /26 dB/32 dB	+4 dBu	-
CHANNEL NAME		A-D	*12 characters	""	-	-
AUTO SLEEP	ON		A-D	OFF/ON	OFF	-
	THRESHOLD			-99.0 dBFS to -40.0 dBFS	-99.0 dBFS	-
	TIME			1min/3min/10min/30min /1hour/3hour	1min	-
INPUT SOURCE REDUNDANC Y	COMMON	MODE	-	BACKUP/OVERRIDE	BACKUP	-
		AUTO RETURN		OFF/ON	OFF	-
	SECOND INPUT SOURCE(Digit al)	ON/OFF	D1-D4	OFF/ON	OFF	-
		OVERRIDE THRESHOLD		-80.0 dBFS to 0.0 dBFS	0.0 dBFS	-
		OVERRIDE RETURN DELAY		0 to 60 sec	10 sec	-
	THIRD INPUT SOURCE(Anal og)	ON/OFF	D1-D4	OFF/ON	OFF	-
		OVERRIDE THRESHOLD		-80.0 dBFS to 0.0 dBFS	0.0 dBFS	-
		OVERRIDE RETURN DELAY		0 to 60 sec	10 sec	-
	LOAD MONITORIN G	ON/OFF		A-D	OFF/ON	OFF
OSC ON/OFF			OFF/ON	OFF	-	
OSC LEVEL			0.0 Vrms to 5.0 Vrms	0.0 Vrms	-	
DETECT FREQ			14.5 kHz to 21.2 kHz	20.0 kHz	-	
HIGH THRESHOLD High Limit			0.0 Ω to 50.0 Ω	50.0 Ω	-	
LOW THRESHOLD			0.0 Ω to 50.0 Ω	0.0 Ω	-	
POWER SUPPLY	STANDBY		-	STANDBY/ON	STANDBY	-
	POWER ON SETTING	POWER ON DEFAULT	-	ALWAYS STANDBY/KEEP PREVIOUS STATE	KEEP PREVIOUS STATE	-
		POWER ON DELAY	-	0 sec to 120 sec	0 sec	-

PARAMETERS			CH/BAND/ PORT	MIN/MAX	DEFAULT	AMP PRES ET	FOCUS RECAL L
GPI	IN	FUNCTION	IN PORT1- 6	8 Functions *5	NO ASSIGN	-	-
		TYPE		ACTIVE HIGH, ACTIVE LOW, IMPULSE	-		
		OPTION1		* Depends on Function	-		
		OPTION2					
	OUT	FUNCTION	OUT PORT 1-4	8 Functions *6	NO ASSIGN		
		TYPE		ACTIVE HIGH, ACTIVE LOW	-		
		OPTION1		* Depends on Function	-		
		OPTION2					
DEVICE	UNIT ID		-	01-FE	01	-	-
	DEVICE NAME			*32 characters	-		
Dante	Fs		-	44.1 kHz/48 kHz/88.1 kHz/96 kHz	96 kHz	-	-
	LATENCY			0.5 ms to 5 ms (In DDM, 40 ms)	0.5 ms		
	SECONDARY PORT			DAISY CHAIN/ REDUNDANT	REDUNDA NT		
NETWORK	IP SETTINGS		-	UNIT ID/DHCP/STATIC IP	DHCP	-	-
	STATIC IP ADDRESS			IPv4	192.168.0. 2		
	SUBNET MASK			IPv4	255.255.25 5.0		
	DEFAULT GATEWAY			IPv4	192.168.0. 1		
PANEL SETUP	BRIGHTNESS		-	1-10	8	-	-
	CONTRAST		-	1-16	5	-	-
	LOCK & DIMMER	AUTO PANEL DIMMER	-	10 sec/30 sec/1min/3min/30min	30min	-	-
		DIMMER BRIGHTNES S		0%/25%/50%/75%	75%		
		AUTO PANEL LOCK		10 sec/30 sec/1min/3min/30min/1 hour/NEVER	NEVER		
		PANEL LOCK MODE		PARTIAL/ALL	PARTIAL		
		ENABLE PANEL UNLOCK PIN		OFF/ON	OFF		
		PANEL UNLOCK PIN		*four-digit number	0000		

PARAMETERS		CH/BAND/ PORT	MIN/MAX	DEFAULT	AMP PRES ET	FOCUS RECAL L
HOME SCREEN	METER POSITION		-	INPUT/OUTPUT	INPUT	-
CLOCK	DATE/TIME	DATE	-	-	-	-
		TIME				

*1: THRU, 6 dB/OCT, 12 dB ADJGc, 12 dB BUT, 12 dB BESSL, 12 dB L-R, 18 dB ADJGc, 18 dB BUT, 18 dB BESSL, 24dB ADJGc, 24dB BUT, 24dB BESSL, 24dB L-R, 36 dB ADJGc,

*2: PEQ, L.SHELF(6 dB/Oct), L.SHELF(12 dB/Oct), H.SHELF(6 dB/Oct), H.SHELF(12 dB/Oct), HPF, LPF

*3: PEQ, L.SHELF(6 dB/Oct), L.SHELF(12 dB/Oct), H.SHELF(6 dB/Oct), H.SHELF(12 dB/Oct), HPF, LPF, APF(1st), APF(2nd), Horn EQ

*4: 25Hz,40 Hz,63Hz,100 Hz,160 Hz,250 Hz,400 Hz,630 Hz,1.0 kHz,1.6 kHz,2.5 kHz,4.0 kHz,6.3kHz,10.0 kHz,16.0 kHz,20.0 kHz

*5: No Assign, Power Amp Start, Channel Mute, Channel Sleep, Standby, Preset Recall, Volume +, Volume -

*6: No Assign, Power Amp Start Status, Redundant Status, CH Impedance Detect Status, CH MUTE Status, Fault Out, Preset Recall

13.4. Message list

Messages appearing in the display of the PC-D/DI series and the appropriate actions are listed below.

- Alert Message
- Log Message

Number	Alert Message	Log Message	SEVERITY	Content	Action
01	-	POWER TURNED ON	INFORMATION	- The power turned on, or - Software reboot was executed	-
02	-	POWER TURNED OFF	INFORMATION	- The power turned off, or - Software reboot was executed	-
03	-	STANDBY MODE TO NORMAL	INFORMATION	The unit transitioned from standby mode to normal operating mode.	-
04	-	NORMAL MODE TO STANDBY	INFORMATION	The unit transitioned from normal operating mode to standby mode.	-
05	Amplifier Output Muting	AMP OUTPUT MUTING	ERROR	The protection function operated to mute the amp output.	Take action to clear the protection function that was the cause. The cause is indicated by another alert that is shown at the same time.
12	Mains Voltage Over 276[V]	MAINS OVER 276V	ERROR	(at startup) The amp cannot start up because the power supply voltage exceeded the allowable operating voltage. The amp stopped because the power supply voltage exceeded the allowable operating voltage.	Connect a stable power supply that is within the power supply requirements.

Number	Alert Message	Log Message	SEVERITY	Content	Action
13	Power Supply Output Voltage	PS OUTPUT VOLTAGE	FAULT	(at startup) The amp cannot start up because there is an abnormality in the output voltage of the power supply circuit.	It might be that the unit has malfunctioned. Contact your Yamaha dealer.
				The amp was stopped because an abnormality occurred in the output voltage of the power supply circuit.	
14	Power Supply Over-temperature	PS OVERTEMP	ERROR	(at startup) The amp cannot start up because the power supply circuit is too hot.	<ul style="list-style-type: none"> - Lower the temperature before use. - Clean the air intake. - Lower the room temperature.
				The amp was stopped because the power supply circuit became abnormally hot.	
21	Amplifier Ch.* DC Output	Ch.* DC OUTPUT	FAULT	(at startup) The amp cannot start up because there is an abnormality in the amp output.	It might be that the unit has malfunctioned. Contact a Yamaha dealer.
				The amp was stopped because there is an abnormality in the amp output of the corresponding channel.	
22	Amplifier Ch.* Overcurrent	Ch.* OVERCURRENT	ERROR	The output was muted because excessive current flowed to the amp of the corresponding channel.	<ul style="list-style-type: none"> - Reduce the output volume so that the current value does not become excessive. - The speaker output jack might be shorted.
23	Amplifier Ch.* Overtemp Level 1	Ch.* OVERTEMP	ERROR	Because the amp temperature of corresponding channel exceeded level 1, the fan rotation speed was raised and the limiter was applied to the output.	<ul style="list-style-type: none"> - Reduce the output volume so that the temperature does not become excessive. - Clean the filter. Also, keep the room temperature constant.

Number	Alert Message	Log Message	SEVERITY	Content	Action
24	Amplifier Ch.* Overtemp Level 2	Ch.* OVERTEMP	ERROR	Because the amp temperature of corresponding channel exceeded level 2, the fan rotation speed was raised and the limiter was applied to the output.	- Reduce the output volume so that the temperature does not become excessive. - Clean the filter. Also, keep the room temperature constant.
25	Amplifier Ch.* Overtemp Level 3	Ch.* OVERTEMP	ERROR	Because the amp temperature of corresponding channel exceeded level 3, the fan rotation speed was raised to the maximum and the output was muted.	- Reduce the output volume so that the temperature does not become excessive. - Clean the filter. Also, keep the room temperature constant.
26	Ch.* High Load	Ch.* HIGH LOAD	WARNING	The impedance value of the corresponding channel monitored by the Load Monitoring function is higher than the specified value.	- Check that there is no abnormality in the speaker or cable. - Check that the Threshold setting value is appropriate.
27	Ch.* Low Load	Ch.* LOW LOAD	WARNING	The impedance value of the corresponding channel monitored by the Load Monitoring function is lower than the specified value.	- Check that there is no abnormality in the speaker or cable. - Check that the Threshold setting value is appropriate.
31	Fan * Error	FAN * ERROR	FAULT	The fan of the corresponding number has stopped rotating.	It might be that the unit has malfunctioned. Contact a Yamaha dealer.
34	Fan Lifetime Warning	-	WARNING	An internal fan has reached its operating lifespan.	Although this will not immediately cause a problem with operation, contact your dealer to have the part replacement.
42	Input D* Change To 2nd	D* CHANGED TO 2ND	WARNING	The Input Redundancy backup mode has switched the audio to the second priority circuit.	- Check whether the main audio circuit (Dante) has malfunctioned. (Note that if the Auto Return function is ON, the circuit might suddenly switch back if the connection recovers.)

Number	Alert Message	Log Message	SEVERITY	Content	Action
43	Input D* Change To 3rd	D* CHANGED TO 3RD	WARNING	The Input Redundancy backup mode has switched the audio to the third priority circuit	- Check whether the main or the second priority audio circuit (Dante) has malfunctioned. (Note that if the Auto Return function is ON, the circuit might suddenly switch back if the connection recovers.)
44	-	D* CHANGED TO 2ND	INFORMATION	The Input Redundancy override mode has switched the audio to the second priority circuit.	-
44	-	D* RETURNED	INFORMATION	The Input Redundancy override mode has restored the audio to the corresponding channel.	-
45	-	D* CHANGED TO 3RD	INFORMATION	The Input Redundancy override mode has switched the audio to the third priority circuit.	-
51	Low Battery	-	WARNING	(at startup) The voltage of the internal battery is low.	Although this will not immediately cause a problem with operation, contact your Yamaha dealer to have the part replacement.
52	No Battery	-	FAULT	(at startup) The internal battery has run down, and the internal clock has stopped.	Contact your Yamaha dealer for replacement.
61	Dante Module Failed	DANTE MODULE FAILED	FAULT	The internal Dante module is not working correctly.	It might be that the unit has malfunctioned. Contact your Yamaha dealer.
62	Dante Module is in Fail Safe Mode	DANTE FAIL SAFE	ERROR	The internal Dante module is in Fail Safe mode.	Because of a failed update etc., the Dante module's firmware was not correctly written. In Dante Firmware Update Manager, select Safe mode and rewrite it.

Number	Alert Message	Log Message	SEVERITY	Content	Action
63	Firmware Versions Mismatch	-	ERROR	The version of this unit's firmware is not compatible with the version of the Dante firmware.	The updater provided on the website contains the firmware for this unit and the Dante firmware as a set. Update both.
64	Dante Is Not Working By Giga Bit	DANTE NOT GIGABIT	ERROR	The network is not connected at 1 GB. In Daisy Chain mode, this alert also occurs when connected to the Control Port. If this unit is disconnected from the network, alert 69 occurs, and this alert is temporarily cleared.	Use a 1GB network switch.
65	Dante Is Working At Secondary	WORK AT SECONDARY	WARNING	In Redundant mode, Dante audio communication is occurring on the Secondary circuit. If this unit is disconnected from the network, alert 69 occurs, and this alert is temporarily cleared.	Check whether the primary circuit may have malfunctioned.
66	Error Occurred At Secondary Port	ERROR AT SECONDARY	WARNING	In Redundant mode, the Dante Primary circuit is operating correctly, but the Secondary circuit is not connected. * Only if connection had once been confirmed, and then been disconnected	If connection of the Secondary circuit is needed, check whether it may have malfunctioned.
67	Wrong Word Clock	WRONG WORD CLOCK	WARNING	A problem was detected in the word clock.	- In Dante Controller, correctly set the word clock of the entire system. - Make sure that the Fs (sampling frequency) setting is the same for the devices whose audio is patched.

Number	Alert Message	Log Message	SEVERITY	Content	Action
68	Unit ID Mismatch	-	ERROR	The UNIT ID and the Dante Device Label do not match.	Defeat restrictions such as the Dante Device Lock function and the Dante Domain Manager function, and then change the UNIT ID.
69	Dante Port Is Not Connected	DANTE PORT IS NOT CONNECTED	WARNING	In Redundant mode, the Dante Primary circuit is operating correctly, but the Secondary circuit is not connected. * This is displayed only if connection had once been confirmed, and then been disconnected.	Make sure that the Dante circuit is correctly connected.

- shows the channel name (1-4, A-D)

■ Sync Message

ID *	Message	Description	Possible Solution
-	NORMAL	Operating normally	-
-	NOT READY	The Dante module is being prepared.	Wait until startup or synchronization is completed. It may take up to 45 seconds for this to be completed.
E01-03	WRONG WORD CLOCK!	The word clock setting is incorrect.	On the Dante Controller, set the clock master and the sampling frequency correctly.
E01-04	DANTE PORT DOES NOT HAVE CONNECTION!	The Dante network is not connected.	Check whether an Ethernet cable might be disconnected or broken.
E01-05	DANTE CONNECTION ERROR!	Other Dante devices cannot be found because the Dante network connections are incorrect.	Check whether the Ethernet cable connections are correct.
E01-06	DANTE IS NOT WORKING BY GIGABIT!	A device that does not support gigabit Ethernet is connected.	If you are conveying audio via Dante, use devices that support gigabit Ethernet.
E01-07	DANTE IS WORKING AT SECONDARY!	In the case of a redundant network, communication is occurring via the [SECONDARY] port.	Check the circuit that is connected to the [PRIMARY] port.
E01-08	ERROR OCCURRED AT SECONDARY PORT!	In the case of a redundant network, a problem has occurred in the circuit that is connected to the [SECONDARY] port.	Check the circuit that is connected to the [SECONDARY] port.
-	DANTE WORD CLOCK MASTER	Functioning correctly as the word clock master.	This indicates that the device is the word clock master.

ID *	Message	Description	Possible Solution
E01-10	DANTE IS NOT WORKING BY GIGABIT!	Functioning correctly as the word clock master. A device that does not support gigabit Ethernet is connected.	This indicates that the device is the word clock master. If you are conveying audio via Dante, use devices that support gigabit Ethernet.
E01-11	DANTE IS WORKING AT SECONDARY!	Functioning correctly as the word clock master. In the case of a redundant network, communication is occurring via the [SECONDARY] port.	This indicates that the device is the word clock master. Check the circuit that is connected to the [PRIMARY] port.
E01-12	ERROR OCCURRED AT SECONDARY PORT!	Functioning correctly as the word clock master. In the case of a redundant network, a problem has occurred in the circuit that is connected to the [SECONDARY] port.	This indicates that the device is the word clock master. Check the circuit that is connected to the [SECONDARY] port.

- If the ID is blank, the message is shown. Otherwise, the ID is shown.

13.5. Troubleshooting

Symptom	Possible causes	Possible solution
Display is not shown	The DIMMER (DIMMER BRIGHTNESS) setting is at 0%.	Set the DIMMER (DIMMER BRIGHTNESS) setting to 25% or higher.
The display indication disappears if the unit is not operated for a time.	To protect the display, the display indication disappears 30 minutes after the PC-D/DI series unit was last operated.	To bring back the display, press any front panel key or turn the knob.
Display is dim.	The PANEL SETUP screen's "BRIGHTNESS" is set to a low value.	Set "BRIGHTNESS" to a high value.
	When no operation is performed for a time, the AUTO DIMMER function automatically dims the screen.	To bring back the display, press any front panel key or turn the knob.
Power does not turn on. Power suddenly turns off, and immediately turns off even if you turn the power on again.	The power supply voltage of the connected AC outlet is significantly outside the allowable range.	Connect a power supply of the appropriate voltage.
	The interior of the amp is at a high temperature, perhaps because an obstruction or dust is blocking the ventilation and impairing the cooling.	Check the ventilation status, and take measure to ensure cooling. Then, after waiting for the unit to cool down, turn the power on again.
	The output level is too high.	Lower the output level.
The sound from the speaker is distorted.	The input level exceeds the input sensitivity setting.	Using the AMP SETTINGS screen's SENS./GAIN setting, adjust the input sensitivity appropriately for the input level.
Sound is muffled. High frequencies are not output.	A filter is applied. The filter status can be viewed in the HOME screen's SP PROCESSOR page.	Use X-OVER to change the filter settings.
No sound from the speakers.	A cable is not connected correctly. If the meter does not rise even when you raise the volume knob, there could be a problem with the input connection. If the meter does rise, there could be a problem with the output connection.	Correctly connect the input jacks and output jacks. For the output connection, also check that you are connected to the jack that is outputting the signal.
	The output is turned down on the mixer connected to the input jack. This is possible if the meter does not rise even when you raise the volume knob.	Raise the mixer's output.
	The level is lowered by the volume knob.	Adjust the volume knob.
	The mute function is on. In the HOME screen you can check whether the mute function is on.	Turn off the mute function.
	The protection circuit has operated to mute the output. If the protection circuit has operated, the display indicates [PROT], and the indicator of the corresponding channel flashes red.	Check the operation log to determine the reason that the protection circuit operated, and correct the cause.
Panel operations are not possible.	Panel lock is enabled.	Defeat the panel lock function. For the method, refer to " To defeat panel lock. "

Symptom	Possible causes	Possible solution
You want to return the parameter settings to their initial values.	-	To return to the initial settings, execute " Returning to the factory settings (Initialization) ".
The edited current parameter returns to the unedited value when the power is turned off and the unit is restarted.	The power was turned off before the current parameter was automatically saved.	Before turning the power off, wait at least three seconds after an editing operation.
Can't patch the unit with a CL series digital mixer using Dante Controller.	The CL series unit's Fs setting is 48 kHz, and this unit's setting is 96 kHz.	In Dante Controller or on this unit, set the Fs to match the setting of the CL series unit.
When you execute Clear Config in Dante Controller, operation becomes unstable.	After Clear Config is executed, the unit will not operate correctly until it is restarted.	If you executed Clear Config, you must restart using one of the following methods. - When executing Clear Config in Dante Controller, put a check mark in [Reboot] - After executing Clear Config, turn this unit's power off and then on again - After executing Clear Config, execute UTILITY > REBOOT from the screen of this unit

13.6. General specifications

		PC412-D	PC406-D	PC412-DI	PC406-DI
Output Power 1 kHz, non-clip, 20 msec burst, all channels driven	16 Ω	600 W \times 4	300 W \times 4	600 W \times 4	300 W \times 4
	8 Ω	1200 W \times 4	600 W \times 4	1200 W \times 4	600 W \times 4
	4 Ω	1900 W \times 4	900 W \times 4	1900 W \times 4	900 W \times 4
	2 Ω	2500 W \times 4	1300 W \times 4	2500 W \times 4	1300 W \times 4
	8 Ω (BRIDGE mode)	3800 W \times 2	1800 W \times 2	3800 W \times 2	1800 W \times 2
	4 Ω (BRIDGE mode)	5000 W \times 2	2600 W \times 2	5000 W \times 2	2600 W \times 2
	Hi-Z (70 V Mode)	-	-	1200 W \times 4	600 W \times 4
	Hi-Z (100 V Mode)	-	-	1200 W \times 4	600 W \times 4
Amplifier Type (Output Circuitry)		Class D, Single ended output			
THD+N	8 Ω , 1 kHz, 10 W, all channels driven	0.01%			
	4 Ω , 1 kHz, half power, all channels driven	0.1%			
	100 V/70 V, 1 kHz, 10 W, all channels driven	-	-	0.01%	
	100 V/70 V, 1 kHz, Half power, all channels driven	-	-	0.1%	
Frequency Response	8 Ω , 1 W, 20 Hz to 20 kHz (HPF THRU)	+0.5, -1.5 dB			
Crosstalk	8 Ω , 1 kHz, half power, input 150 Ω shunt A- weighted	\leq -60 dB			
S/N Ratio	8 Ω , gain setting = 32 dB, A- weighted	112 dB	109 dB	112 dB	109 dB

		PC412-D	PC406-D	PC412-DI	PC406-DI
Voltage Gain/Sensitivity	8 Ω Volume max	32.0 dB/+10.0 dBu (Gain setting: 32 dB), 26.0 dB/+16.0 dBu (Gain setting: 26 dB), 38.0 dB/+4.0 dBu (Input Sensitivity Setting: +4 dBu), 28.0 dB/+14.0 dBu (Input Sensitivity Setting: +14 dBu)	32.0 dB/+7.0 dBu (Gain setting: 32 dB), 26.0 dB/+13.0 dBu (Gain setting: 26 dB), 35.0 dB/+4.0 dBu (Input Sensitivity Setting: +4 dBu), 25.0 dB/+14.0 dBu (Input Sensitivity Setting: +14 dBu)	32.0 dB/+10.0 dBu (Gain setting: 32 dB), 26.0 dB/+16.0 dBu (Gain setting: 26 dB), 38.0 dB/+4.0 dBu (Input Sensitivity Setting: +4 dBu), 28.0 dB/+14.0 dBu (Input Sensitivity Setting: +14 dBu)	32.0 dB/+7.0 dBu (Gain setting: 32 dB), 26.0 dB/+13.0 dBu (Gain setting: 26 dB), 35.0 dB/+4.0 dBu (Input Sensitivity Setting: +4 dBu), 25.0 dB/+14.0 dBu (Input Sensitivity Setting: +14 dBu)
	Hi-Z 100 V mode, Volume max	-	-	32.0 dB/+10.2 dBu (Gain setting: 32 dB), 26.0 dB/+16.2 dBu (Gain setting: 26 dB), 38.2 dB/+4.0 dBu (Input Sensitivity Setting: +4 dBu), 28.2 dB/+14.0 dBu (Input Sensitivity Setting: +14 dBu)	32.0 dB/+10.2 dBu (Gain setting: 32 dB), 26.0 dB/+16.2 dBu (Gain setting: 26 dB), 38.2 dB/+4.0 dBu (Input Sensitivity Setting: +4 dBu), 28.2 dB/+14.0 dBu (Input Sensitivity Setting: +14 dBu)
	Hi-Z 70 V mode, Volume max	-	-	32.0 dB/+7.2 dBu (Gain setting: 32 dB), 26.0 dB/+13.2 dBu (Gain setting: 26 dB), 35.2 dB/+4.0 dBu (Input Sensitivity Setting: +4 dBu), 25.2 dB/+14.0 dBu (Input Sensitivity Setting: +14 dBu)	32.0 dB/+7.2 dBu (Gain setting: 32 dB), 26.0 dB/+13.2 dBu (Gain setting: 26 dB), 35.2 dB/+4.0 dBu (Input Sensitivity Setting: +4 dBu), 25.2 dB/+14.0 dBu (Input Sensitivity Setting: +14 dBu)
Load Protection	POWER switch on/off	Output mute			
	Output voltage protection	Over voltage limiter, user configurable by wattage and speaker preset			
	DC-fault	Power supply shutdown (NOT restored automatically)			
Amplifier Protection	Thermal	Output limiter (Restored automatically) → Output mute (Restored automatically)			
	Over current	Output mute (Restored automatically)			
	Over voltage	Output limiter (Restored automatically)			
	Integrated Power Limit	Output limiter (Restored automatically)			
Power Supply Protection	Thermal	Output limiter (Restored automatically) → Power supply shutdown			
	Over voltage	Power supply shutdown			
	Over current	Power supply shutdown			
Cooling		3 x 7 step variable speed fan, front to rear airflow			
Maximum input voltage		+28 dBu	+25 dBu	+28 dBu	+28 dBu

		PC412-D	PC406-D	PC412-DI	PC406-DI
Input impedance		20 kΩ (balanced)			
Sampling Frequency		96 kHz			
A/D, D/A Converters		AD: 24-bit linear DA: 24-bit linear			
Dante interface	Channel count	16 IN with Dante Redundancy, 16 OUT			
	Sampling frequency	96/88.2/48/44.1 kHz			
	Dante Latency	0.25/0.5/1/2/5 ms			
	Bit depth	32/24 bit			
Signal Processing		20 x 8 input matrix mixer Room EQ: 16 band IIR EQ Room Delay: 0 - 1000 msec Speaker Processor: X-Over(IIR/FIR*), PEQ(16 band IIR/FIR*), Delay, Peak Limiter, RMS Limiter *Configured only by Speaker Preset recall			
Latency	Analog Input to Speakers	1.5 msec			
	Dante Input to Speakers (Dante latency setup = 0.25msec)	1.8 msec (fs=96 kHz) 1.9 msec (fs=88.2 kHz) 2.5 msec (fs=48 kHz) 2.7 msec (fs=44.1 kHz)			
Amplifier Preset		32 user preset, 5 factory preset			
Speaker Preset		Factory presets for Yamaha passive speakers			
Connectors	Analog input	XLR-3-31 x 4		Euro block 6pin x 2 (4ch balanced input)	
	Dante Interface	etherCON x 2 (Redundant/Daisy Chain)		RJ45 x 2 (Redundant/Daisy Chain)	
	Speakers	Neutrik speakON NL4 x 4		7.62mm Euro block 8 pin x 1	
	Controls	RJ45 x 1			
	Remote, Fault Output	Euro block 8 pin (mini) x 2 (GPI x 4, GPO x 6, +5 V x 2)			
	AC IN	AC inlet (powerCON 20A) x 1			
Controls	Front Panel	POWER switch, Rotary encoder with function button and 8 buttons for GUI control Operation lock feature (Full lock or Lock except volume and mute)			
	Display	128 x 64 pixel, mono color with brightness adjustment Auto display off feature			
Indicators		Power (Green) x 1 Channel Status x 4 : Signal (Green) Limit (Yellow) Protect/Mute (Red) Auto LED off and dimmer feature (except POWER LED)			
AC Power Requirements	Voltage *1	100 V-240 V 50 Hz/60 Hz			

		PC412-D	PC406-D	PC412-DI	PC406-DI
Power consumption	1/8 MAX power, 2 Ω, pink noise at all channels	1850 W	1050 W	1850 W	1100 W
	idle	190 W	165 W	190 W	190 W
	Standby	120 V/ 9 W 230 V/ 12 W			
Operating temperature		0 degrees to +40 degrees			
Storage temperature		-20 degrees to +60 degrees			
Dimensions (W × H × D)		480 × 88 × 528 mm			
Weight (with grill and handles)		16.0 kg	15.6 kg	16.0 kg	15.9 kg

*1 The unit has been verified to operate through a ±10% voltage variance from the rated power supply voltage.



NOTICE

- When measuring the amplifier output, use a measuring device that supports balance input.
- Incorrect connection will fail to provide a proper ground connection, causing the amplifier or the measuring device to malfunction.

The explanations in this document use the latest specifications as of the date of publication. The latest version can be downloaded from the Yamaha website.

13.7. Current draw

PC412-D/PC412-DI

Power Specifications (PINK NOISE, 100 V/50 Hz mains)

MODE		Line Current (A)	Power Consumption (W)	Watts Dissipated (W)	Heat Dissipation (Btu/h)	Heat Dissipation (kcal/h)
stanby	-	0.2	8	8	2	7
idle	-	2.0	184	184	40	158
sleep	all channel	1.2	99	99	22	85
1/8 output power	16ohms/ch	5.6	529	229	50	197
	8ohms/ch	9.0	888	288	62	248
	4ohms/ch	14.0	1418	468	101	402
	2ohms/ch	18.7	1850	600	130	516
	100 V(8 Ω)	9.0	888	288	62	248
	70.7 V(4 Ω)	9.4	932	332	72	286
1/3 output power	16ohms/ch	11.3	1125	325	70	280
	8ohms/ch	20.6	2033	433	94	372
	4ohms/ch	33.9	3387	854	185	734
	2ohms/ch	45.7	4518	1185	257	1019
	100 V(8 Ω)	20.6	2033	433	94	372
	70.7 V(4 Ω)	22.2	2226	626	136	538

Test signal Pink Noise , bandwidth limited 22 Hz to 22 kHz

All channels driven, 1BTU = 1,055.06J = 0.252kcal, (W) × 86 = cal

PC412-D/PC412-DI

Power Specifications (PINK NOISE, 120 V/60 Hz mains)

MODE		Line Current (A)	Power Consumption (W)	Watts Dissipated (W)	Heat Dissipation (Btu/h)	Heat Dissipation (kcal/h)
standby	-	0.2	8	8	2	7
idle	-	1.7	180	180	39	155
sleep	all channel	1.0	97	97	21	84
1/8 output power	16ohms/ch	4.6	521	221	48	190
	8ohms/ch	7.7	890	290	63	249
	4ohms/ch	11.4	1382	432	94	372
	2ohms/ch	14.9	1805	555	120	477
	100 V(8 Ω)	7.7	890	290	63	249
	70.7 V(4 Ω)	8.1	941	341	74	293
1/3 output power	16ohms/ch	9.5	1124	324	70	279
	8ohms/ch	17.3	2088	488	106	420
	4ohms/ch	27.6	3318	785	170	675
	2ohms/ch	36.8	4385	1052	228	904
	100 V(8 Ω)	17.3	2088	488	106	420
	70.7 V(4 Ω)	18.3	2196	596	129	513

Test signal Pink Noise , bandwidth limited 22 Hz to 22 kHz
 All channels driven, 1BTU = 1,055.06J = 0.252kcal, (W) × 86 = cal

PC412-D/PC412-DI

Power Specifications (PINK NOISE, 230 V/50 Hz mains)

MODE		Line Current (A)	Power Consumption (W)	Watts Dissipated (W)	Heat Dissipation (Btu/h)	Heat Dissipation (kcal/h)
standby	-	0.3	12	12	2	10
idle	-	1.1	177	177	38	152
sleep	all channel	0.7	96	96	21	83
1/8 output power	16ohms/ch	2.6	519	219	47	188
	8ohms/ch	4.3	916	316	68	272
	4ohms/ch	6.3	1351	401	87	345
	2ohms/ch	8.0	1773	523	113	450
	100 V(8 Ω)	4.3	916	316	68	272
	70.7 V(4 Ω)	4.5	938	338	73	291
1/3 output power	16ohms/ch	5.1	1115	315	68	271
	8ohms/ch	9.0	2053	453	98	390
	4ohms/ch	14.1	3215	682	148	586
	2ohms/ch	18.8	4272	939	203	807
	100 V(8 Ω)	9.0	2053	453	98	390
	70.7 V(4 Ω)	9.5	2178	578	125	497

PC406-D

Power Specifications (PINK NOISE, 100 V/50 Hz mains)

MODE		Line Current (A)	Power Consumption (W)	Watts Dissipated (W)	Heat Dissipation (Btu/h)	Heat Dissipation (kcal/h)
standby	-	0.2	8	8	2	7
idle	-	1.8	160	160	35	137
sleep	all channel	1.1	93	93	20	80
1/8 output power	16ohms/ch	3.7	334	184	40	158
	8ohms/ch	5.4	515	215	47	185
	4ohms/ch	7.7	734	284	62	244
	2ohms/ch	10.8	1054	404	88	347
1/3 output power	16ohms/ch	6.6	632	232	50	200
	8ohms/ch	11.3	1124	324	70	279
	4ohms/ch	16.5	1657	457	99	393
	2ohms/ch	23.9	2400	667	144	573

Test signal Pink Noise , bandwidth limited 22 Hz to 22 kHz
 All channels driven, 1BTU = 1,055.06J = 0.252kcal, (W) × 86 = cal

PC406-D

Power Specifications (PINK NOISE, 120 V/60 Hz mains)

MODE		Line Current (A)	Power Consumption (W)	Watts Dissipated (W)	Heat Dissipation (Btu/h)	Heat Dissipation (kcal/h)
stanby	-	0.2	8	8	2	7
idle	-	1.5	160	160	35	138
sleep	all channel	1.0	93	93	20	80
1/8 output power	16ohms/ch	2.9	330	180	39	155
	8ohms/ch	4.5	511	211	46	181
	4ohms/ch	6.3	730	280	61	241
	2ohms/ch	8.5	1030	380	82	327
1/3 output power	16ohms/ch	5.5	620	220	48	189
	8ohms/ch	9.2	1103	303	66	261
	4ohms/ch	13.3	1628	428	93	368
	2ohms/ch	20.3	2355	622	135	535

PC406-D

Power Specifications (PINK NOISE, 230 V/50 Hz mains)

MODE		Line Current (A)	Power Consumption (W)	Watts Dissipated (W)	Heat Dissipation (Btu/h)	Heat Dissipation (kcal/h)
stanby	-	0.3	11	11	2	10
idle	-	1.0	158	158	34	136
sleep	all channel	0.7	94	94	20	81
1/8 output power	16ohms/ch	1.7	311	161	35	138
	8ohms/ch	2.5	478	178	39	153
	4ohms/ch	3.5	698	248	54	213
	2ohms/ch	4.7	1011	361	78	310
1/3 output power	16ohms/ch	3.0	596	196	42	169
	8ohms/ch	5.1	1107	307	67	264
	4ohms/ch	7.3	1567	367	80	316
	2ohms/ch	10.3	2310	577	125	496

Test signal Pink Noise , bandwidth limited 22 Hz to 22 kHz
 All channels driven, 1BTU = 1,055.06J = 0.252kcal, (W) × 86 = cal

PC406-DI

Power Specifications (PINK NOISE, 100 V/50 Hz mains)

MODE		Line Current (A)	Power Consumption (W)	Watts Dissipated (W)	Heat Dissipation (Btu/h)	Heat Dissipation (kcal/h)
standby	-	0.2	9	9	2	7
idle	-	1.9	178	178	39	153
sleep	all channel	1.2	95	95	21	81
1/8 output power	16ohms/ch	3.7	369	219	47	188
	8ohms/ch	5.8	537	237	51	204
	4ohms/ch	7.8	791	341	74	293
	2ohms/ch	10.5	1080	430	93	370
	100 V(16 Ω)	5.5	528	228	49	196
	70.7 V(8 Ω)	5.8	537	237	51	204
1/3 output power	16ohms/ch	6.4	637	237	51	204
	8ohms/ch	11.5	1149	349	76	300
	4ohms/ch	17.2	1697	497	108	427
	2ohms/ch	25.0	2488	755	164	649
	100 V(16 Ω)	11.7	1164	364	79	313
	70.7 V(8 Ω)	11.5	1149	349	76	300

Test signal Pink Noise , bandwidth limited 22 Hz to 22 kHz
 All channels driven, 1BTU = 1,055.06J = 0.252kcal, (W) × 86 = cal

PC406-DI

Power Specifications (PINK NOISE, 120 V/60 Hz mains)

MODE		Line Current (A)	Power Consumption (W)	Watts Dissipated (W)	Heat Dissipation (Btu/h)	Heat Dissipation (kcal/h)
standby	-	0.2	8	8	2	7
idle	-	1.6	176	176	38	151
sleep	all channel	1.0	94	94	20	81
1/8 output power	16ohms/ch	3.0	350	200	43	172
	8ohms/ch	4.7	534	234	51	201
	4ohms/ch	6.5	754	304	66	261
	2ohms/ch	8.8	1034	384	83	330
	100 V(16 Ω)	4.6	524	224	49	193
	70.7 V(8 Ω)	4.7	534	234	51	201
1/3 output power	16ohms/ch	5.8	640	240	52	206
	8ohms/ch	9.9	1140	340	74	292
	4ohms/ch	13.9	1664	464	101	399
	2ohms/ch	20.7	2456	723	157	621
	100 V(16 Ω)	9.4	1107	307	67	264
	70.7 V(8 Ω)	9.9	1140	340	74	292

Test signal Pink Noise , bandwidth limited 22 Hz to 22 kHz
 All channels driven, 1BTU = 1,055.06J = 0.252kcal, (W) × 86 = cal

PC406-DI

Power Specifications (PINK NOISE, 230 V/50 Hz mains)

MODE		Line Current (A)	Power Consumption (W)	Watts Dissipated (W)	Heat Dissipation (Btu/h)	Heat Dissipation (kcal/h)
standby	-	0.3	11	11	2	10
idle	-	1.1	172	172	37	148
sleep	all channel	0.7	93	93	20	80
1/8 output power	16ohms/ch	1.9	339	189	41	163
	8ohms/ch	2.6	519	219	47	188
	4ohms/ch	3.7	751	301	65	259
	2ohms/ch	4.8	1008	358	78	308
	100 V(16 Ω)	2.6	512	212	46	182
	70.7 V(8 Ω)	2.6	519	219	47	188
1/3 output power	16ohms/ch	3.2	624	224	49	193
	8ohms/ch	5.1	1126	326	71	280
	4ohms/ch	7.8	1616	416	90	358
	2ohms/ch	10.4	2345	612	133	526
	100 V(16 Ω)	5.3	1121	321	70	276
	70.7 V(8 Ω)	5.1	1126	326	71	280

Test signal Pink Noise , bandwidth limited 22 Hz to 22 kHz
 All channels driven, 1BTU = 1,055.06J = 0.252kcal, (W) × 86 = cal

13.8. Dimensions

Unit:mm

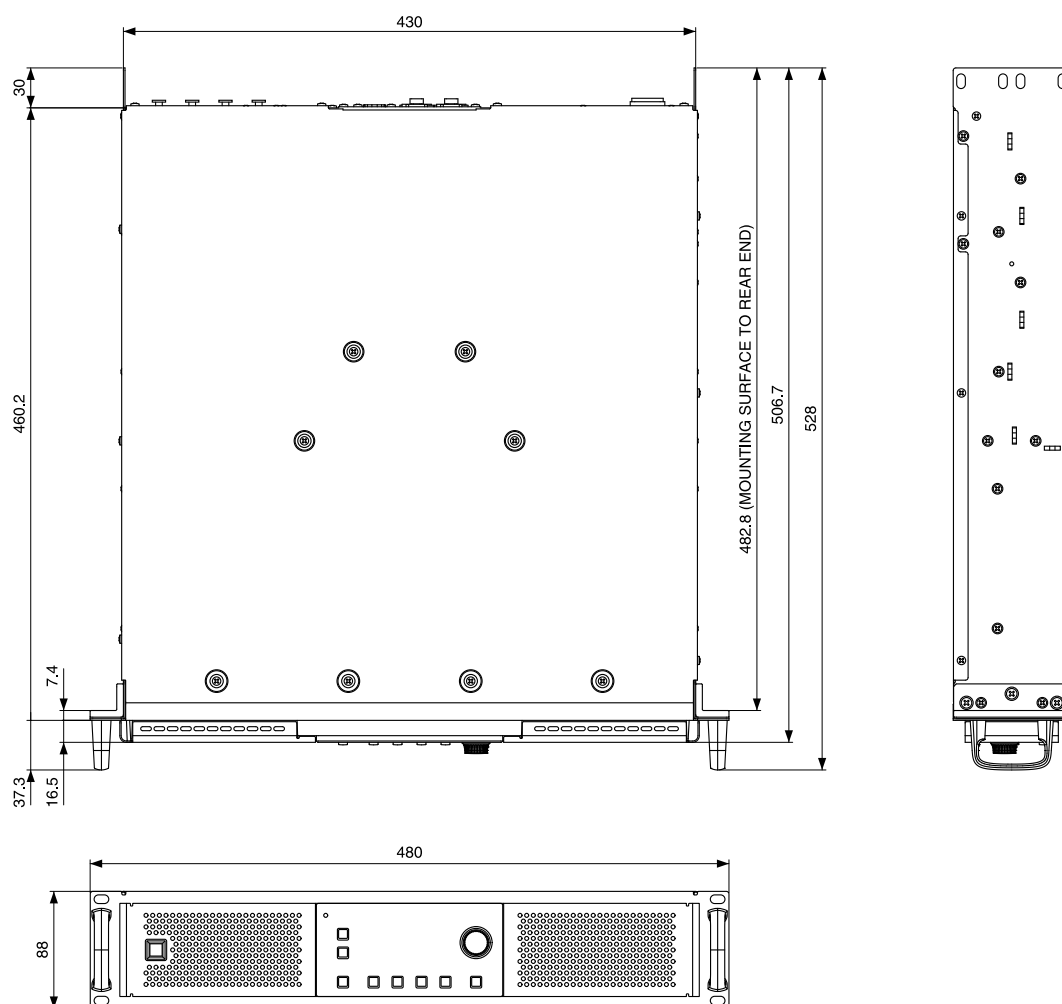

13.9. Block Diagram

PC412-D/PC406-D/PC412-DI/PC406-DI

Block Diagram

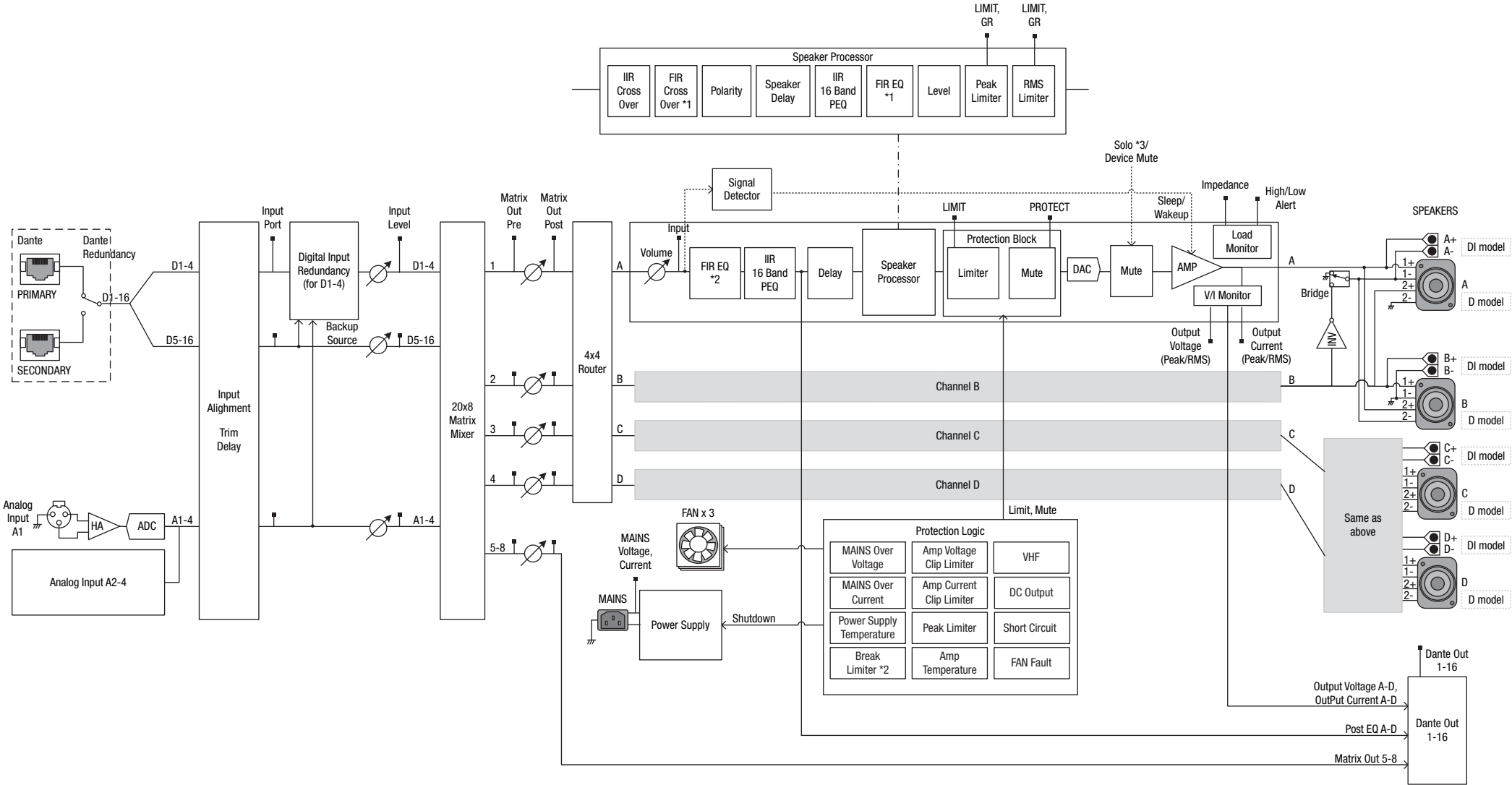

*1 Can be configured only by recalling Speaker Preset data.
 *2 Available in future firmware release.
 *3 Accessible only from PC software.

Manual Development Group
© 2019 Yamaha Corporation
Published 10/2021
YJMA-D0