



AV Receiver

RX-V383

Owner's Manual

-
- This unit is a product for enjoying video and music at home.
 - This manual explains preparations and operations for everyday users of the unit.
 - Read the supplied booklet "Quick Start Guide" before using the unit.

CONTENTS

BEFORE USING THE UNIT 4

Accessories.....	4
How to use this manual.....	4
Remote control.....	4
Insert the batteries.....	4
Operating range of the remote control.....	4

FEATURES 5

What you can do with the unit.....	5
Part names and functions.....	7
Front panel.....	7
Front display (indicators).....	8
Rear panel.....	9
Remote control.....	10

PREPARATIONS 11

1 Placing speakers.....	12
Typical speaker layouts.....	13
Other speaker layouts.....	14
Setting the speaker impedance.....	15
2 Connecting speakers.....	16
Connecting speaker cables.....	17
Connecting the subwoofer (with built-in amplifier).....	17
3 Connecting a TV/playback devices.....	18
Input/output jacks and cables.....	18
Connecting a TV.....	19
Connecting video devices (such as BD/DVD players).....	20
Connecting audio devices (such as CD players).....	22
Connecting to the jack on the front panel.....	22
4 Connecting the FM/AM antennas.....	23
5 Connecting the power cable.....	23

6 Selecting an on-screen menu language.....	24
7 Optimizing the speaker settings automatically (YPAO).....	25
Error messages.....	27
Warning messages.....	28

PLAYBACK 29

Basic playback procedure.....	29
Enjoying playback.....	29
Switching information on the front display.....	30
Selecting the input source and favorite settings with one touch (SCENE).....	31
Selecting a registered scene.....	31
Registering a scene.....	31
Selecting the sound mode.....	32
Enjoying sound field effects (CINEMA DSP).....	33
Enjoying unprocessed playback.....	35
Enhancing the bass (Extra Bass).....	36
Playing back digitally compressed formats (such as MP3, etc.) with enriched sound (Compressed Music Enhancer).....	36
Listening to FM/AM radio.....	37
Setting the frequency steps.....	37
Selecting a frequency for reception.....	37
Registering favorite radio stations (presets).....	38
Radio Data System tuning.....	41
Playing back music stored on a Bluetooth® device.....	42
Connecting a Bluetooth® device (pairing).....	42
Playback of Bluetooth® device contents.....	43
Enjoying audio using Bluetooth® speakers/headphones.....	43
Playing back music stored on a USB storage device.....	44
Connecting a USB storage device.....	44
Playback of USB storage device contents.....	44

Configuring playback settings for different playback sources (Option menu).....	47
Option menu items.....	47

CONFIGURATIONS 51

Configuring various functions (Setup Menu).....	51
Setup menu items.....	52
Speaker.....	54
HDMI.....	57
Sound.....	59
ECO.....	61
Function.....	62
Bluetooth.....	64
Language.....	65
Configuring the system settings (ADVANCED SETUP menu).....	66
ADVANCED SETUP menu items.....	66
Changing the speaker impedance setting (SP IMP.).....	66
Selecting the remote control ID (REMOTE ID).....	67
Changing the FM/AM tuning frequency setting (TU).....	67
Switching the video signal type (TV FORMAT).....	67
Selecting the HDMI 4K signal format (4K MODE).....	68
Restoring the default settings (INIT).....	68
Updating the firmware (UPDATE).....	68
Checking the firmware version (VERSION).....	68

APPENDIX 69

Frequently asked questions.....	69
Troubleshooting.....	70
First, check the following:.....	70
Power, system and remote control.....	70
Audio.....	71
Video.....	73
FM/AM radio.....	74
USB.....	74
Bluetooth®.....	75
Error indications on the front display.....	76

Glossary.....	77
Audio information.....	77
HDMI and video information.....	78
Yamaha technologies.....	78
Supported devices and file formats.....	79
Supported devices.....	79
File formats.....	79
Video signal flow.....	79
Information on HDMI.....	80
HDMI Control.....	80
Audio Return Channel (ARC).....	82
HDMI signal compatibility.....	82
Trademarks.....	83
Specifications.....	84

BEFORE USING THE UNIT

Accessories

Check that the following accessories are supplied with the product.

AM antenna



FM antenna

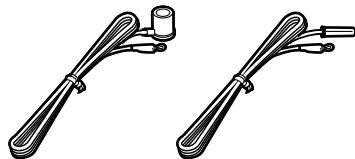

YPAO microphone

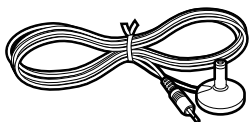

* One of the above is supplied depending on the region of purchase.

Remote control

Batteries (AAA, R03, UM-4) (x2)

CD-ROM (Owner's Manual)

Quick Start Guide

How to use this manual

- Some features are not available in certain regions.
- Due to product improvements, specifications and appearance are subject to change without notice.
- This manual explains operations using the supplied remote control.

Notice:

Indicates precautions for use to avoid the possibility of malfunction/damage to the unit.

Note:

Indicates instructions and supplementary explanations for optimum use.

Remote control

The supplied remote control is used as follows.

Insert the batteries

Insert the batteries the right way round.

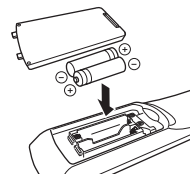

Operating range of the remote control

Point the remote control at the remote control sensor on the unit and remain within the operating range shown below.

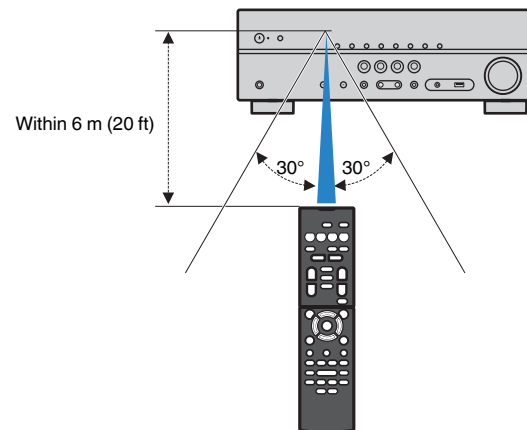

FEATURES

What you can do with the unit

The unit is equipped with full of useful functions.

Supports 2- to 5.1-channel speaker system

You can enjoy your favorite acoustic spaces in various styles.

YPAO automatically optimizes the speaker settings to suit your room.

- “Optimizing the speaker settings automatically (YPAO)” (p.25)

CINEMA DSP allows you to create stereo or multichannel sounds with the sound fields like actual movie theaters and concert halls in your own room.

- “Enjoying sound field effects (CINEMA DSP)” (p.33)

You can enjoy compressed music with enhanced sound (Compressed Music Enhancer).

- “Playing back digitally compressed formats (such as MP3, etc.) with enriched sound (Compressed Music Enhancer)” (p.36)

Change the input source and favorite settings with one touch (SCENE)

The SCENE function allows you to select the input source and settings registered to the corresponding scene, such as sound program and Compressed Music Enhancer on/off, with just one touch.

- “Selecting the input source and favorite settings with one touch (SCENE)” (p.31)

4K Ultra HD signal and HDCP 2.2 supported

You can enjoy the high definition video quality of 4K with HDCP 2.2 that complies with the latest copyright protection.

- “Selecting the HDMI 4K signal format (4K MODE)” (p.68)

The ECO mode (power saving function) allows you to create an eco-friendly home theater system

When the ECO mode is enabled, you can reduce the unit's power consumption.

- “ECO Mode” (p.61)

Sequential operation of a TV, AV receiver, and BD/DVD player (HDMI Control)

When the unit is connected to an HDMI Control-compatible TV and BD/DVD player with each HDMI cable, you can control the unit (such as power and volume) and BD/DVD player with TV remote control operations.

- “HDMI Control” (p.80)

Supports Bluetooth® devices

You can play back music stored on a Bluetooth device.

- “Playing back music stored on a Bluetooth® device” (p.42)

Supports USB storage devices

You can play back music stored on a USB storage device.

- “Playing back music stored on a USB storage device” (p.44)

Connecting various devices

A number of HDMI jacks and various input/output jacks on the unit allow you to connect video devices (such as BD/DVD players), audio devices (such as CD players), game consoles, portable audio player, and other devices.

- “Connecting a TV/playback devices” (p.18)

Playing back TV audio in surround sound with a single HDMI cable connection (Audio Return Channel: ARC)

When using an ARC-compatible TV, you only need one HDMI cable to enable video output to the TV, audio input from the TV, and the transmission of HDMI Control signals.

- “Connecting a TV” (p.19)

Surround playback with 5 speakers placed in front

You can enjoy the surround sound even when the surround speakers are placed in front.

- “Enjoying sound field effects without surround speakers (Virtual CINEMA DSP)” (p.34)

Enhanced bass reproduction

Extra Bass allows you to enjoy enhanced bass reproduction that does not depend on the speakers used.

- “Enhancing the bass (Extra Bass)” (p.36)

Listening to FM/AM radio

The unit is equipped with a built-in FM/AM tuner. You can register up to 40 favorite radio stations as presets.

- “Listening to FM/AM radio” (p.37)

Easy operation with a TV screen

You can operate the USB storage device, view information, or easily configure the settings using the on-screen menu.

Auto Rename function

The unit creates an input source name, displayed on the front display, automatically according to the connected HDMI-compatible device.

- “Input Rename” (p.62)

Useful applications

The useful application for connections and operations of the unit is as follows.

Application for tablets “AV SETUP GUIDE”



AV SETUP GUIDE is an application that assists you with cable connections between AV Receiver and source devices as well as AV Receiver setup. This app guides you through the various settings such as speaker connections, TV and source device connections.

Functions:

- 1) Connection support guide
 - Speaker connection
 - TV/source devices connection
- 2) Setup support guide
 - Various setup assistance with illustrations.
 - YPAO setting guidance
- 3) View Owner's Manual

* This application is for tablets only.

For details, search for “AV SETUP GUIDE” on the App Store or Google Play™.

Part names and functions

The part names and functions of the unit and the supplied remote control are as follows.

Front panel

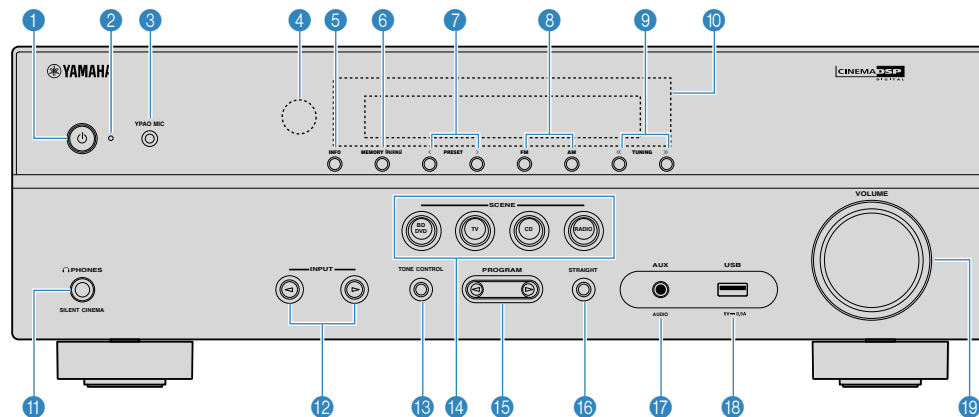

1 **⏻ (power) key**

Turns on/off (standby) the unit.

2 **Standby indicator**

Lights up when the unit is in Bluetooth Standby enable condition (p.64).

3 **YPAO MIC jack**

For connecting the supplied YPAO microphone (p.25).

4 **Remote control sensor**

Receives remote control signals (p.4).

5 **INFO key**

Selects the information displayed on the front display (p.30).

6 **MEMORY (PAIRING) key**

Registers FM/AM radio stations as preset stations (p.38).
Starts pairing with a Bluetooth device by holding down for 3 seconds (p.42).

7 **PRESET keys**

Select a preset FM/AM radio station (p.40).

8 **FM and AM keys**

Switch between FM and AM (p.37).

9 **TUNING keys**

Select the radio frequency (p.37).

10 **Front display**

Displays information (p.8).

11 **PHONES jack**

For connecting headphones.

12 **INPUT keys**

Select an input source.

13 **TONE CONTROL key**

Adjusts the level of high-frequency range (Treble) and low-frequency range (Bass) individually (p.48).

14 **SCENE keys**

Select the registered input source and sound program with one touch. Also, turns on the unit when it is in standby mode (p.31).

15 **PROGRAM keys**

Select a sound program or a surround decoder (p.32).

16 **STRAIGHT key**

Enables/disables the straight decode mode (p.35).

17 **AUX jack**

For connecting devices, such as portable audio players (p.22).

18 **USB jack**

For connecting a USB storage device (p.44).

19 **VOLUME knob**

Adjusts the volume.

Front display (indicators)

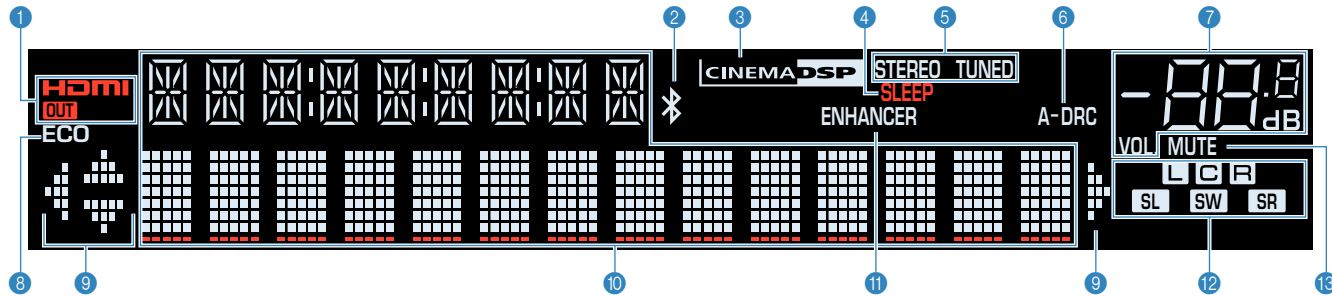

1 HDMI

Lights up when HDMI signals are being input or output.

OUT

Lights up when HDMI signals are being output.

2 Bluetooth indicator

Light up while the unit is connected to a Bluetooth device.

3 CINEMA DSP

Lights up when CINEMA DSP (p.33) is working.

4 SLEEP

Lights up when the sleep timer is on.

5 STEREO

Lights up when the unit is receiving a stereo FM radio signal.

TUNED

Lights up when the unit is receiving an FM/AM radio station signal.

6 A-DRC

Lights up when Adaptive DRC (p.48) is working.

7 Volume indicator

Indicates the current volume.

8 ECO

Lights up when the eco mode (p.61) is enabled.

9 Cursor indicators

Indicate the remote control cursor keys currently operational.

10 Information display

Displays the current status (such as input name and sound mode name). You can switch the information by pressing INFO (p.30).

11 ENHANCER

Lights up when Compressed Music Enhancer (p.36) is working.

12 Speaker indicators

Indicate speaker terminals from which signals are output.

L Front speaker (L)

R Front speaker (R)

C Center speaker

SL Surround speaker (L)

SR Surround speaker (R)

SW Subwoofer

13 MUTE

Blinks when audio is temporarily muted.

Rear panel

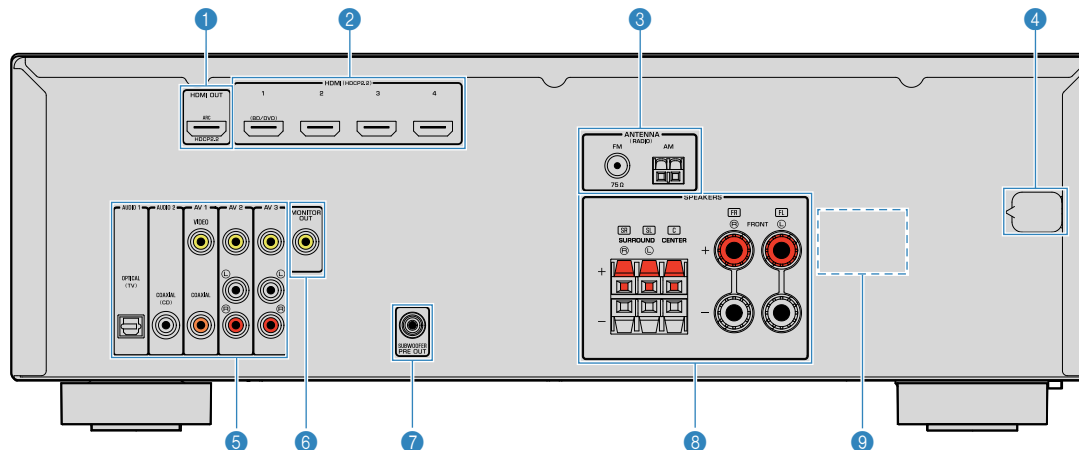

• The area around the video/audio output jacks is marked in white on the actual product to prevent improper connections.

1 HDMI OUT jack

For connecting to an HDMI-compatible TV and outputting video/audio signals (p.18). When using ARC, TV audio signal can also be input through the HDMI OUT jack.

2 HDMI 1–4 jacks

For connecting to HDMI-compatible playback devices and inputting video/audio signals (p.20).

3 ANTENNA jacks

For connecting to FM and AM antennas (p.23).

4 Power cable

For connecting to an AC wall outlet (p.23).

5 AV jacks AUDIO jacks

For connecting to video/audio playback devices and inputting video/audio signals (p.20).

6 MONITOR OUT jacks

For connecting to a TV and outputting video signals (p.18).

7 SUBWOOFER PRE OUT jack

For connecting to a subwoofer (with built-in amplifier) (p.16).

8 SPEAKERS terminals

For connecting to speakers (p.16).

9 VOLTAGE SELECTOR

(Taiwan, Brazil and General models only)
Selects the switch position according to your local voltage (p.23).

Remote control

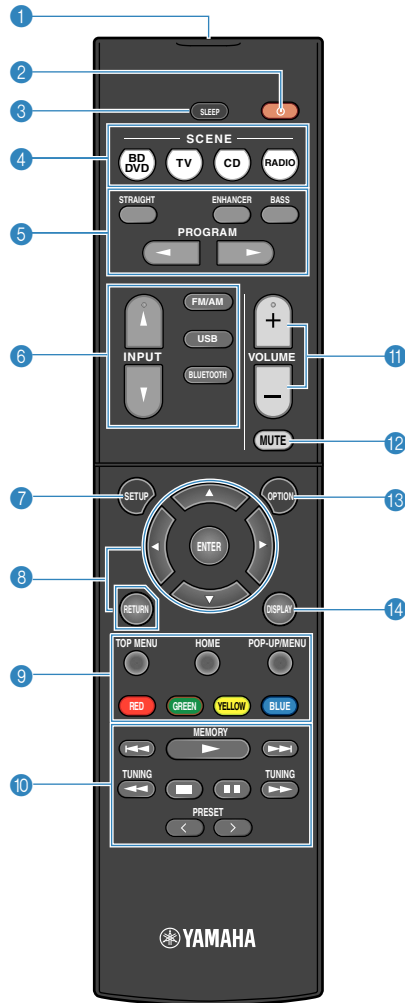

1 Remote control signal transmitter

Transmits infrared signals.

2 (receiver power) key

Turns on/off (standby) the unit.

3 SLEEP key

Pressing this key repeatedly will specify the time (120 min, 90 min, 60 min, 30 min, off), in which the unit switches to the standby mode.

4 SCENE keys

Select the registered input source and sound program with one touch. Also, turn on the unit when it is in standby mode (p.31).

5 Sound mode keys

Select a sound mode (p.32).

6 Input selection keys

Select an input source for playback.

7 SETUP key

Displays the setup menu (p.51).

8 Menu operation keys

Cursor keys Select a menu or the parameter.

ENTER Confirms a selected item.

RETURN Returns to the previous screen.

8 9 10 External device operation keys

Let you perform playback operations when "USB" is selected as the input source, or control playback of the HDMI Control-compatible playback device.

Note

- The playback devices must support HDMI Control. Some HDMI Control-compatible devices cannot be used.
- You can assign the unit's functions to the RED/GREEN/YELLOW/BLUE keys (p.64).

10 Radio keys

Operate the FM/AM radio when "TUNER" is selected as the input source (p.37).

MEMORY Registers FM/AM radio stations as presets.

PRESET Select a preset station.

TUNING Select the radio frequency.

11 VOLUME keys

Adjust the volume.

12 MUTE key

Mutes the audio output.

13 OPTION key

Displays the option menu (p.47).

14 DISPLAY key

Turns on/off the browse screen, playback screen, etc.

PREPARATIONS

General setup procedure

- 1** **Placing speakers..... (p.12)**
- 2** **Connecting speakers..... (p.16)**
- 3** **Connecting a TV/playback devices..... (p.18)**
- 4** **Connecting the FM/AM antennas..... (p.23)**
- 5** **Connecting the power cable..... (p.23)**
- 6** **Selecting an on-screen menu language..... (p.24)**
- 7** **Optimizing the speaker settings automatically (YPAO)..... (p.25)**

This completes all the preparations. Enjoy playing movies, music, radio and other content with the unit!

1 Placing speakers

Select the speaker layout for the number of speakers that you are using and place the speakers and subwoofer in your room. This section describes the representative speaker layout examples.

Notice

- (U.S.A. and Canada models only)
Under its default settings, the unit is configured for 8-ohm speakers. When connecting 6-ohm speakers, set the unit's speaker impedance to "6 Ω MIN". For details, see "Setting the speaker impedance" (p.15).
- (Except for U.S.A. and Canada models)
Use speakers with an impedance of at least 6 Ω.
- Use a subwoofer with built-in amplifier.
- Be sure to connect the front left and right speakers.

Typical speaker layouts

5.1-channel system

We recommend this speaker layout which can maximize the performance of the unit.

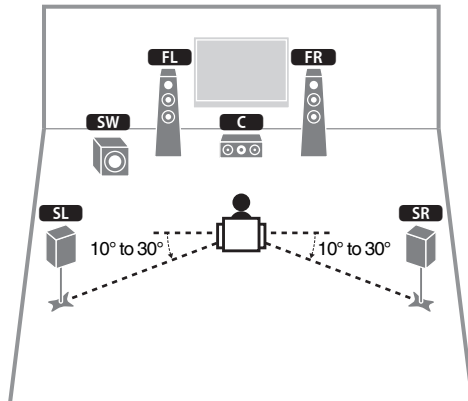

Speaker type	Abbr.	Function
Front (L/R)	FL / FR	Produce front left/right channel sounds (stereo sounds).
Center	C	Produces center channel sounds (such as movie dialogue and vocals).
Surround (L/R)	SL / SR	Produce surround left/right channel sounds.
Subwoofer	SW	Produces LFE (low-frequency effect) channel sounds and reinforces the bass parts of other channels. This channel is counted as "0.1".

Note

- You can enjoy surround sound even without the center speaker (4.1-channel system).
- You can place the subwoofer either in the left or right side.

5.1-channel system (Virtual CINEMA FRONT)

We recommend this speaker layout when the speakers can't be placed in back of the room.

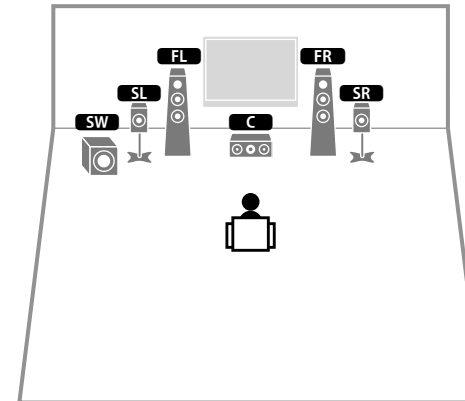

Speaker type	Abbr.	Function
Front (L/R)	FL / FR	Produce front left/right channel sounds (stereo sounds).
Center	C	Produces center channel sounds (such as movie dialogue and vocals).
Surround (L/R)	SL / SR	Produce surround left/right channel sounds. By this system, place the surround speakers in front.
Subwoofer	SW	Produces LFE (low-frequency effect) channel sounds and reinforces the bass parts of other channels. This channel is counted as "0.1".

Note

- To utilize this configuration, set "Virtual CINEMA FRONT" (p.55) in the "Setup" menu to "On".
- You can enjoy surround sound even without the center speaker (front 4.1-channel system).
- You can place the subwoofer either in the left or right side.

Other speaker layouts

The following speaker layouts are also available.

■ 3.1-channel system

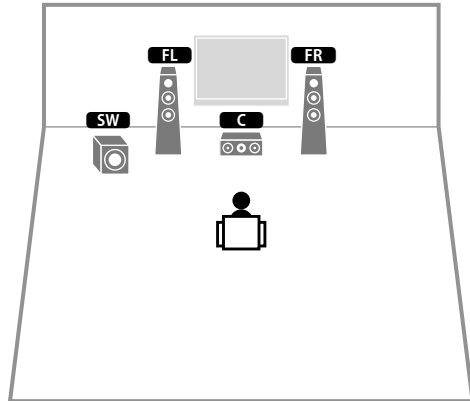

■ 2.1-channel system

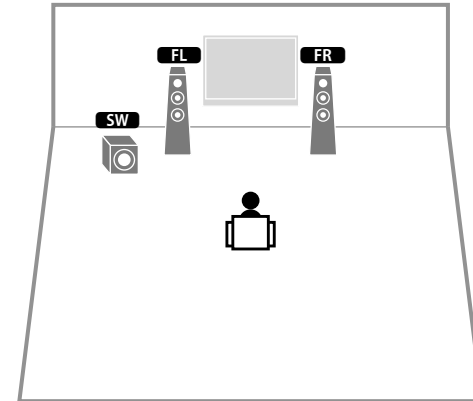

Setting the speaker impedance

(U.S.A. and Canada models only)

Under its default settings, the unit is configured for 8-ohm speakers. When connecting 6-ohm speakers, set the speaker impedance to "6 Ω MIN".

- 1 Before connecting speakers, connect the power cable to an AC wall outlet.**
- 2 While holding down STRAIGHT on the front panel, press  (power).**

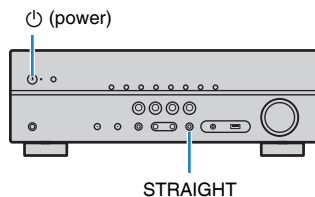

- 3 Check that "SP IMP." is displayed on the front display.**



- 4 Press STRAIGHT to select "6 Ω MIN".**
- 5 Press  (power) to set the unit to standby mode and remove the power cable from the AC wall outlet.**

You are now ready to connect the speakers.

2 Connecting speakers

Connect the speakers placed in your room to the unit. The following diagrams provide connections for a 5.1-channel system as an example. For other systems, connect speakers while referring to the connection diagram for the 5.1-channel system.

Notice

- Remove the unit's power cable from an AC wall outlet and turn off the subwoofer before connecting the speakers.
- The speaker has the polarity (+/-). Connect the speaker cable correctly between the positive (+) terminal of the unit and the speaker, and also between the negative (-) terminal of them.

Cables required for connection (commercially available)

Speaker cables (x the number of speakers)



Audio pin cable (x1: for connecting a subwoofer)

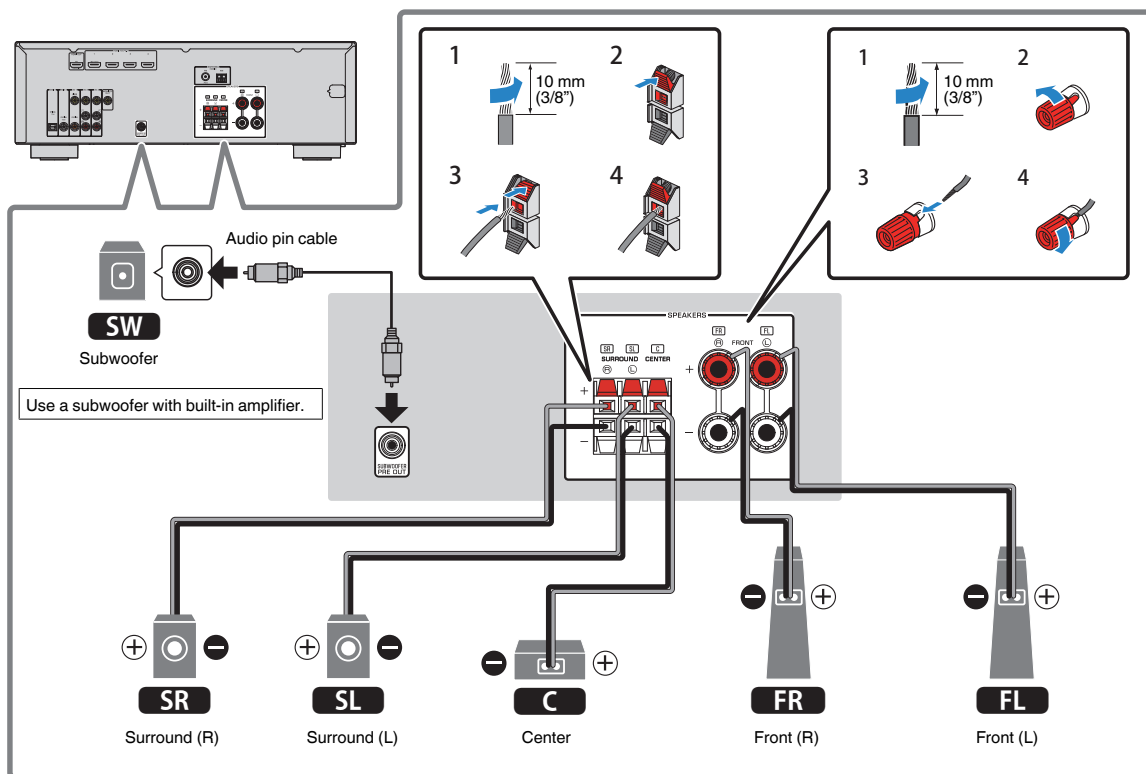

Precaution for connecting of the speaker cables

- Prepare speaker cables in a place away from the unit, to avoid accidentally dropping wire strands into the unit's interior which could result in a short circuit or malfunction of the unit.

- Improper connecting of the speaker cables may cause short circuit and also damage the unit or the speakers.

- Twist the bare wires of the speaker cables firmly together.

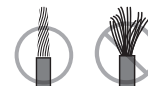

- Do not let the bare wires of the speaker cable touch one another.

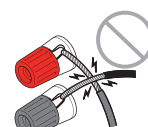

- Do not let the bare wires of the speaker cable come into contact with the unit's metal parts (rear panel and screws).

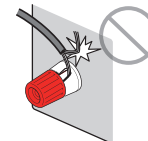

- If "Check SP Wires" appear on the front display when the unit is turned on, turn off the unit, and then check the speaker cables short circuit.

Connecting speaker cables

Speaker cables have two wires. One is for connecting the negative (-) terminals of the unit and the speaker to each other, and the other is for the positive (+) terminals. If the wires are colored to prevent confusion, connect the black wire to the negative and the other wire to the positive terminal.

■ Connecting front speakers

- 1 Remove approximately 10 mm (3/8") of insulation from the ends of the speaker cable, and twist the bare wires of the cable firmly together.
- 2 Loosen the speaker terminal.
- 3 Insert the bare wires of the cable into the gap on the side (upper right or bottom left) of the terminal.
- 4 Tighten the terminal.

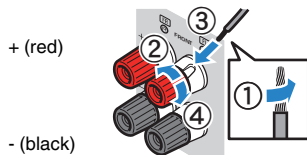

Using a banana plug

(U.S.A., Canada, Taiwan, Brazil and General models only)

- 1 Tighten the speaker terminal.
- 2 Insert a banana plug into the end of the terminal.

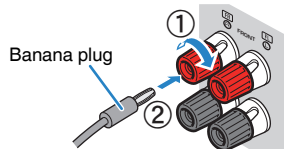

■ Connecting center/surround speakers

- 1 Remove approximately 10 mm (3/8") of insulation from the ends of the speaker cable, and twist the bare wires of the cable firmly together.
- 2 Press down the tab.
- 3 Insert the bare wires of the cable into the hole in the terminal.
- 4 Release the tab.

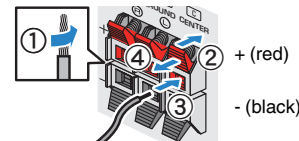

Connecting the subwoofer (with built-in amplifier)

Use an audio pin cable to connect the subwoofer.

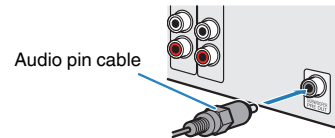

3 Connecting a TV/playback devices

The unit is equipped with a variety of input jacks including HDMI input jacks to allow you to connect different types of playback devices. For information on how to connect a Bluetooth device or a USB storage device, see the following pages.

- Connecting a Bluetooth device (p.42)
- Connecting a USB storage device (p.44)

Input/output jacks and cables

Video/audio jacks

HDMI jacks

Transmit digital video and digital sound through a single jack. Use an HDMI cable.

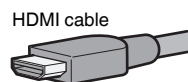

Note

- Use a 19-pin HDMI cable with the HDMI logo. We recommend using a cable less than 5.0 m (16.4 ft) long to prevent signal quality degradation.
- The unit's HDMI jacks support the HDMI Control, Audio Return Channel (ARC), and 3D and 4K Ultra HD video transmission (through output) features.
- Use a Premium High Speed HDMI Cable or Premium High Speed Cable with Ethernet to enjoy 3D or 4K Ultra HD videos.

Video jacks

VIDEO jacks

Transmit analog video signals. Use a video pin cable.

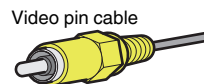

Audio jacks

OPTICAL jack

Transmit digital audio signals. Use a digital optical cable. If there is a protective cap on the tip of the cable, remove it before using the cable.

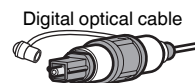

COAXIAL jacks

Transmit digital audio signals. Use a digital coaxial cable.



AUDIO jacks

(Stereo L/R jacks)

Transmit analog stereo audio signals. Use a stereo pin cable (RCA cable).

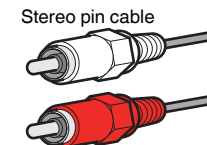

(Stereo mini jack)

Transmits analog stereo audio signals. Use a stereo mini-plug cable.



Connecting a TV

Connect a TV to the unit so that video input to the unit can be output to the TV. You can also enjoy playback of TV audio on the unit.

To maximize the performance of the unit, we recommend connecting a TV with an HDMI cable.

HDMI connection

Connect the TV to the unit with an HDMI cable and a digital optical cable.

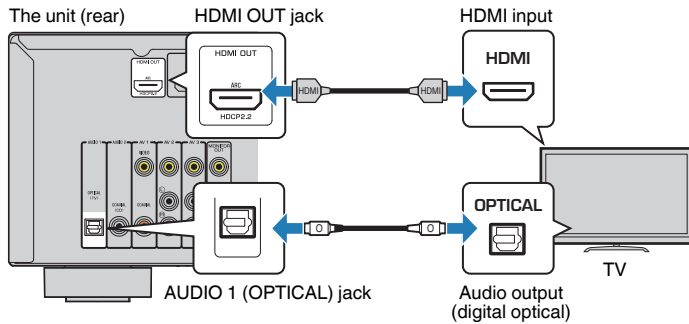

Note

- A digital optical cable connection allows audio from the TV to be played back on the unit. A digital optical cable connection is not needed in the following cases:
 - If your TV supports Audio Return Channel (ARC)
 - If you will receive TV broadcasts only from the set-top box
- If you connect a TV that supports HDMI Control to the unit with an HDMI cable, you can control the unit's power and volume with the TV's remote control.

To use HDMI Control and ARC, you need to configure the HDMI settings on the unit. For details on the settings, see "Information on HDMI" (p.80).

About Audio Return Channel (ARC)

- ARC allows audio signals to travel both ways. If you connect a TV that supports ARC to the unit with a single HDMI cable, you can output video/audio to the TV or input TV audio to the unit.
- When using ARC, connect a TV with an HDMI cable that supports ARC.

Composite video connection

When connecting any video device with a video pin cable, connect the TV to the MONITOR OUT (VIDEO) jack.

Note

- If you connect your TV to the unit with a cable other than HDMI, video input to the unit via HDMI cannot be output to the TV.
- Operations with TV screen are available only when your TV is connected to the unit via HDMI.
- If you will receive TV broadcasts only from the set-top box, you do not need to make an audio cable connection between the TV and the unit.

VIDEO (composite video) connection

Connect the TV to the unit with a video pin cable and a digital optical cable.

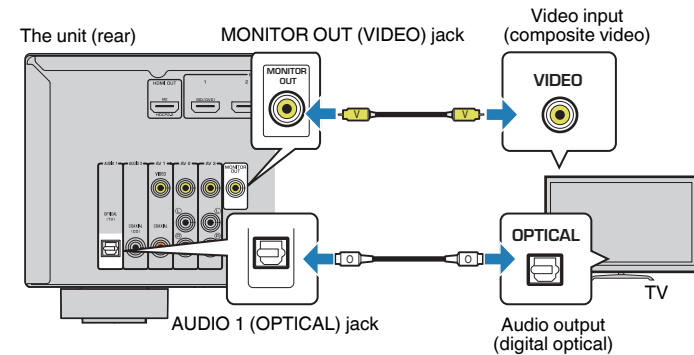

Connecting video devices (such as BD/DVD players)

Connect video devices such as BD/DVD players, set-top boxes (STBs) and game consoles to the unit. Depending on the video/audio output jacks available on your video device, choose one of the following connections. We recommend using an HDMI connection if the video device has an HDMI output jack.

Note

If the combination of video/audio input jacks available on the unit does not match your video device, change its combination according to the output jacks of your device (p.21).

HDMI connection

Connect a video device to the unit with an HDMI cable.

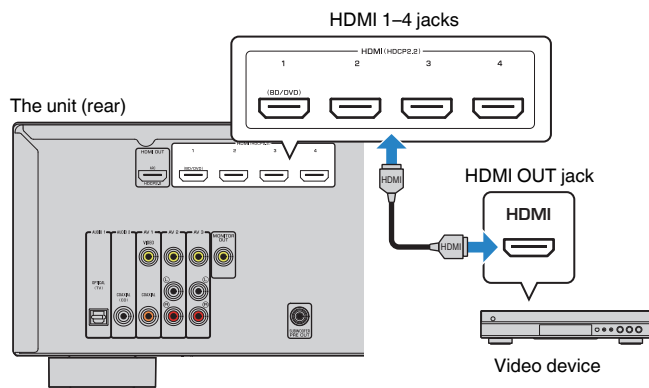

If you select HDMI 1-4 as the input source by pressing INPUT, the video/audio played back on the video device will be output from the unit.

Note

To watch videos input to the HDMI 1-4 jacks, you need to connect your TV to the HDMI OUT jack of the unit (p.19).

Composite video connection

Connect a video device to the unit with a video pin cable and an audio cable (digital coaxial or stereo pin cable). Choose a set of input jacks (on the unit) depending on the audio output jacks available on your video device.

Output jacks on video device		Input jacks on the unit
Video	Audio	
Composite video	Digital coaxial	AV 1 (VIDEO + COAXIAL)
	Analog stereo	AV 2-3 (VIDEO + AUDIO)
	Digital optical	You need to change the combination of video/audio input jacks (p.21).

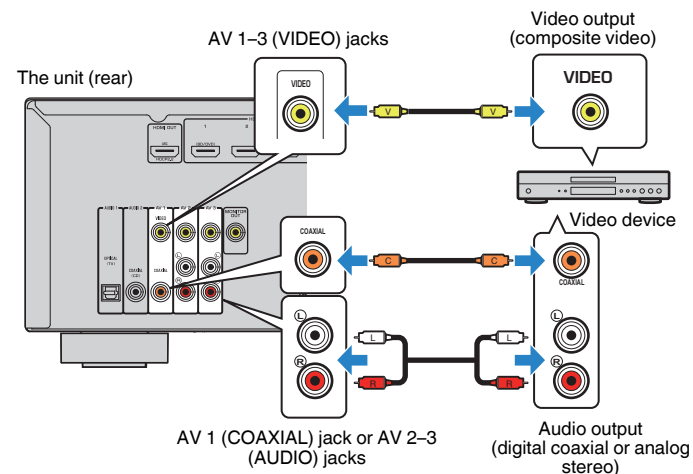

If you select AV 1-3 as the input source by pressing INPUT, the video/audio played back on the video device will be output from the unit.

Note

To watch videos input to the AV 1-3 (VIDEO) jacks, you need to connect your TV to the MONITOR OUT (VIDEO) jack of the unit (p.19).

■ Changing the combination of video/audio input jacks

If the combination of video/audio input jacks available on the unit does not match your video device, change its combination according to the output jacks of your device. You can connect a video device that has the following video/audio output jacks.

Output jacks on video device		Input jacks on the unit	
Video	Audio	Video	Audio
HDMI	Digital optical	HDMI 1-4	AUDIO 1 (OPTICAL)
	Digital coaxial	HDMI 1-4	AUDIO 2 (COAXIAL) AV 1 (COAXIAL)
	Analog stereo	HDMI 1-4	AV 2-3 (AUDIO)
Composite video	Digital optical	AV 1-3 (VIDEO)	AUDIO 1 (OPTICAL)

Necessary setting

For example, if you have connected a video device to AV 2 (VIDEO) and AUDIO 1 (OPTICAL) jack of the unit, change the combination setting as follows.

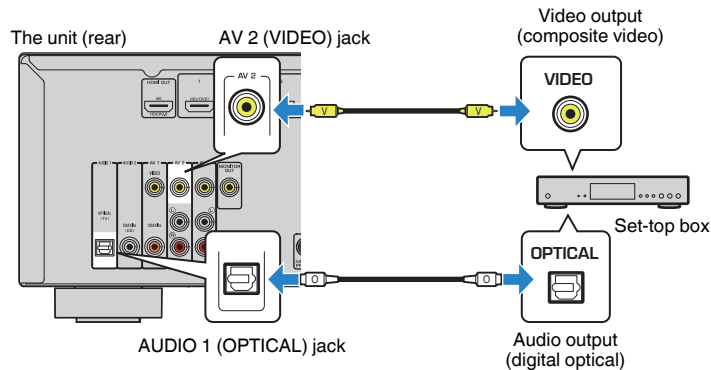

- 1 After connecting external devices (such as a TV and playback devices) and power cable of the unit, turn on the unit.
- 2 Press INPUT to select “AV 2” (video input jack to be used) as the input source.

- 3 Press OPTION.

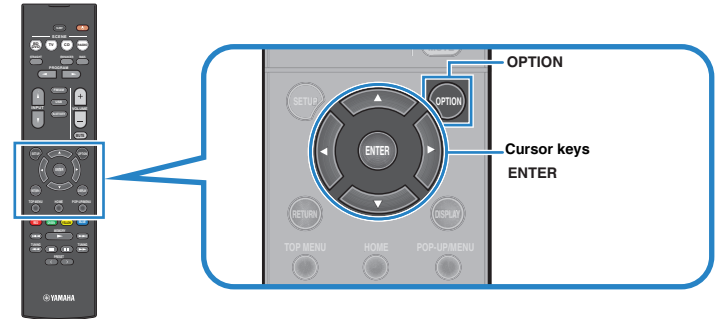

- 4 Use the cursor keys (Δ/∇) to select “Audio In” and press ENTER.



- 5 Use the cursor keys ($\triangleleft/\triangleright$) to select “AUDIO 1” (audio input jack to be used).



- 6 Press OPTION.

This completes the necessary settings.

If you select “AV 2” as the input source by pressing INPUT, the video/audio played back on the video device will be output from the unit.

Connecting audio devices (such as CD players)

Connect audio devices such as CD players and MD players to the unit. Depending on the audio output jacks available on your audio device, choose one of the following connections.

Audio output jacks on audio device	Audio input jacks on the unit
Digital optical	AUDIO 1 (OPTICAL)
Digital coaxial	AUDIO 2 (COAXIAL) AV 1 (COAXIAL)
Analog stereo	AV 2-3 (AUDIO)

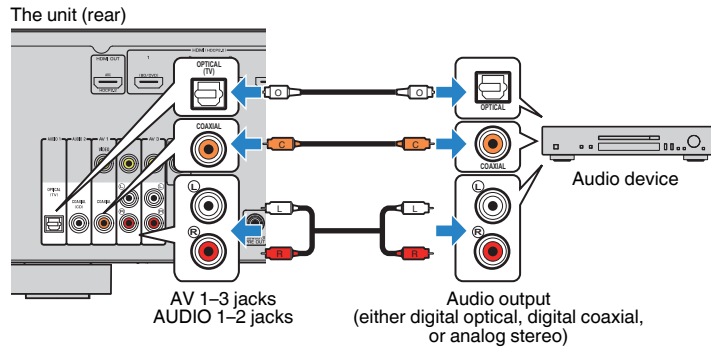

If you select AV 1-3 or AUDIO 1-2 as the input source by pressing INPUT, the audio played back on the audio device will be output from the unit.

Connecting to the jack on the front panel

Use the AUX jack on the front panel to temporarily connect devices such as portable audio players to the unit.

Before making a connection, stop playback on the device and turn down the volume on the unit.

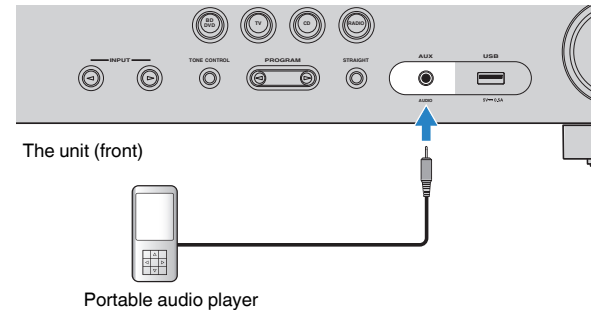

If you select "AUX" as the input source by pressing INPUT, the audio played back on the device will be output from the unit.

Note

- You need to prepare the audio cable that matches the output jacks on your device.
- For details on how to connect a USB storage device, see "Connecting a USB storage device" (p.44).

4 Connecting the FM/AM antennas

Connect the supplied FM/AM antennas to the unit.

Fix the end of the FM antenna to a wall, and place the AM antenna on a flat surface.

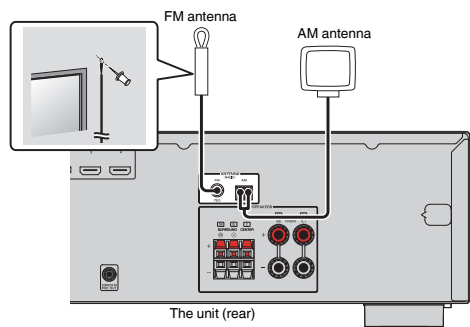

Assembling and connecting the AM antenna

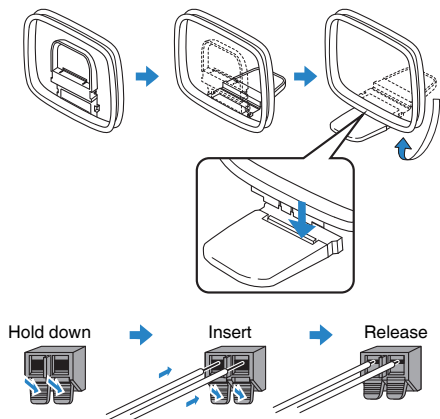

Note

- Unwind only the length of cable needed from the AM antenna unit.
- The wires of the AM antenna have no polarity.

5 Connecting the power cable

Warning

(Taiwan, Brazil and General models only)

Make sure you set VOLTAGE SELECTOR of the unit BEFORE plugging the power cable into an AC wall outlet. Improper setting of VOLTAGE SELECTOR may cause damage to the unit and create a potential fire hazard.

Before connecting the power cable

Set the switch position of VOLTAGE SELECTOR according to your local voltage. Voltages are AC 110–120/220–240 V, 50/60 Hz.

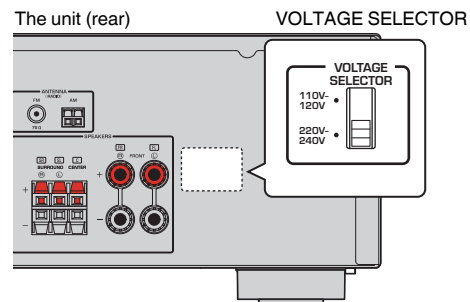

After all the connections are complete, plug in the power cable.

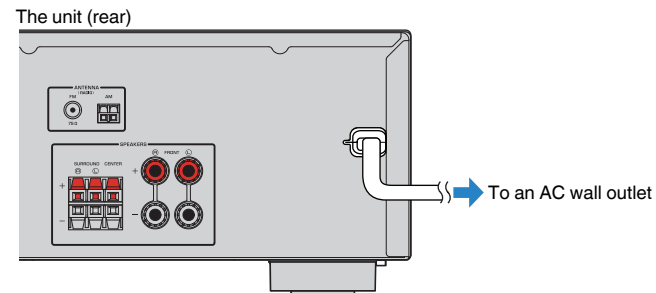

6 Selecting an on-screen menu language

Select the desired on-screen menu language.

- 1 Press **⏻** (receiver power) to turn on the unit.
- 2 Turn on the TV and switch the TV input to display video from the unit (HDMI OUT jack).

Note

Operations with TV screen are available only when your TV is connected to the unit via HDMI. If not, carry out operations while viewing the front display.

- 3 Press **SETUP**.
- 4 Use the cursor keys to select “Language” and press **ENTER**.

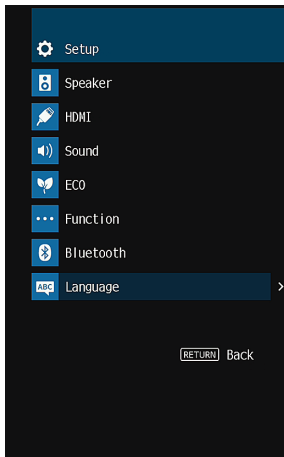

- 5 Use the cursor keys to select the desired language.

- 6 To exit from the menu, press **SETUP**.

Note

The information on the front display is provided in English only.

7 Optimizing the speaker settings automatically (YPAO)

The Yamaha Parametric room Acoustic Optimizer (YPAO) function detects speaker connections, measures the distances from them to your listening position(s), and then automatically optimizes the speaker settings, such as volume balance and acoustic parameters, to suit your room.

Note

- When you use the front 5.1-channel speaker (Virtual CINEMA FRONT) configuration (p.13), set “Virtual CINEMA FRONT” (p.55) in the “Setup” menu to “On” beforehand.
- Please note the following when using YPAO.
 - Use YPAO after connecting a TV and speakers to the unit.
 - During the measuring process, test tones are output at high volume. Ensure that the test tones do not frighten small children.
 - During the measuring process, you cannot adjust the volume.
 - During the measuring process, keep the room as quiet as possible.
 - Do not connect headphones.
 - Do not stand between the speakers and the YPAO microphone during the measurement process (about 3 minutes).

1 Press  (receiver power) to turn on the unit.

2 Turn on the TV and switch the TV input to display video from the unit (HDMI OUT jack).

Note

Operations with TV screen are available only when your TV is connected to the unit via HDMI. If not, carry out operations while viewing the front display.

3 Turn on the subwoofer and set the volume to half. If the crossover frequency is adjustable, set it to maximum.

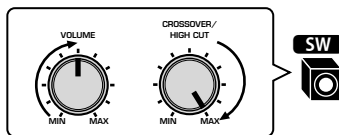

4 Place the YPAO microphone at your listening position and connect it to the YPAO MIC jack on the front panel.

Note

Place the YPAO microphone at your listening position (same height as your ears). We recommend the use of a tripod as a microphone stand. You can use the tripod screws to stabilize the microphone.

The unit (front)

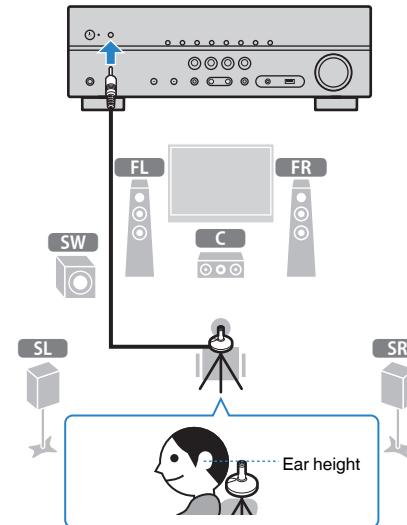

The following screen appears on the TV.

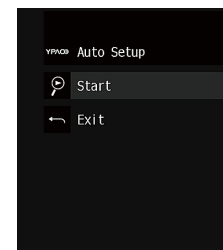

5 To start the measurement, use the cursor keys to select “Start” and press ENTER.

The measurement will start in 10 seconds. Press ENTER to start the measurement immediately.

Note

To stop the measurement temporarily, press RETURN and follow the procedure in “Error messages” (p.27).

The following screen appears on the TV when the measurement finishes.

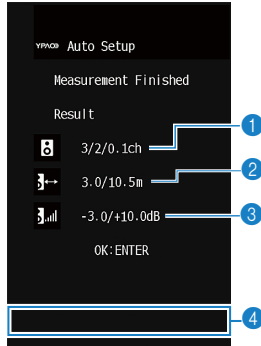

- 1 The number of speakers (front side/rear side/subwoofer)
- 2 Speaker distance (nearest/farthest)
- 3 Adjustment range of speaker output level
- 4 Warning message (if available)

Note

- If any error message (such as E-1) or warning message (such as W-1) appears, see “Error messages” (p.27) or “Warning messages” (p.28).
- A speaker with a problem is indicated by blinking of the speaker indicators in the front display.
- If multiple warnings are given (when operating with the front display), use the cursor keys (Δ/∇) to check the other warning messages.

6 Confirm the results displayed on the screen and press ENTER.

7 Use the cursor keys (\triangle/∇) to select “SAVE” and press ENTER.

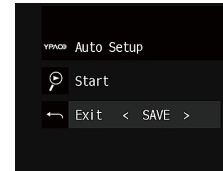

The adjusted speaker settings are applied.

Note

To finish the measurement without saving the result, select “CANCEL”.

8 Disconnect the YPAO microphone from the unit.

This completes optimization of the speaker settings.

Notice

- The YPAO microphone is sensitive to heat, so should not be placed anywhere where it could be exposed to direct sunlight or high temperatures (such as on top of AV equipment).

Error messages

If any error message is displayed during the measurement, resolve the problem and perform YPAO again.

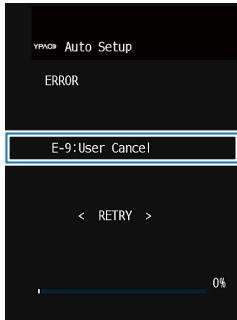

Error message

TV screen



Front display

■ Procedure to handle errors

- 1 Check the content of error message and press ENTER.
- 2 Use the cursor keys (</>) to select the desired operation.

To exit the YPAO measurement:

- 1 Select “EXIT” and press ENTER.
- 2 Use the cursor keys (Δ/▽) to select “Exit” and press ENTER.
- 3 Disconnect the YPAO microphone from the unit.

To retry the YPAO measurement from beginning:

- 1 Select “RETRY” and press ENTER.

To proceed with the current YPAO measurement (for E-5 and E-9 only):

- 1 Select “PROCEED” and press ENTER.

Error message	Cause	Remedy
E-1:No Front SP (E-1:NO FRNT SP)	Front speakers are not detected.	Exit YPAO, turn off the unit, and then check the speaker connections.
E-2:No Sur. SP (E-2:NO SUR SP)	One of the surround speakers cannot be detected.	
E-5:Noisy (E-5:NOISY)	The noise is too loud.	Keep the room quiet and retry YPAO. If you select “PROCEED”, YPAO takes the measurement again and ignores any noise detected.
E-7:No MIC (E-7:NO MIC)	The YPAO microphone has been removed.	Connect the YPAO microphone to the YPAO MIC jack firmly and retry YPAO.
E-8:No Signal (E-8:NO SIGNAL)	The YPAO microphone cannot detect test tones.	Connect the YPAO microphone to the YPAO MIC jack firmly and retry YPAO. If this error occurs repeatedly, contact the nearest authorized Yamaha dealer or service center.
E-9:User Cancel (E-9:CANCEL)	The measurement has been canceled.	Retry or exit YPAO as necessary.
E-10:Internal Err. (E-10:INTERNAL)	An internal error has occurred.	Exit YPAO, and turn off and on the unit. If this error occurs repeatedly, contact the nearest authorized Yamaha dealer or service center.

Note

Texts in parentheses denote indicators on the front display.

Warning messages

If a warning message is displayed after the measurement, you can still save the measurement results by following on-screen instructions.

However, we recommend you perform YPAO again in order to use the unit with the optimal speaker settings.

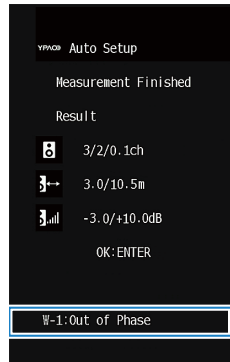

Warning message

TV screen

Problem speaker (blinks)



Front display

Procedure to handle warnings

- 1 Check the content of warning message and press ENTER.
- 2 Use the cursor keys (◀/▶) to select the desired operation.
 - To save the measurement results:
 - 1 Select “SAVE” and press ENTER.
 - To discard the measurement result:
 - 1 Select “CANCEL” and press ENTER.
- 3 Disconnect the YPAO microphone from the unit.

Warning message	Cause	Remedy
W-1: Out of Phase (W-1:PHASE)	A speaker cable may be connected with the reverse polarity (+/-).	<p>Check the cable connections (+/-) of the problem speaker.</p> <p>If the speaker is connected incorrectly: Turn off the unit, reconnect the speaker cable.</p> <p>If the speaker is connected correctly: Depending on the type of speakers or room environment, this message may appear even if the speakers are connected correctly. In this case, you can ignore the message.</p>
W-2: Over Distance (W-2:DISTANCE)	A speaker is placed more than 24 m (80 ft) from the listening position.	Exit YPAO, turn off the unit, and place the problem speaker within 24 m (80 ft) of the listening position.
W-3: Level Error (W-3:LEVEL)	There are significant volume differences between the speakers.	Check the usage environment and cable connections (+/-) of each speaker, and the volume of the subwoofer. If there is any problem, exit YPAO, turn off the unit, and then reconnect speaker cable or correct the speaker positions. We recommend using the same speakers or speakers with specifications that are as similar as possible.

Note

Texts in parentheses denote indicators on the front display.

PLAYBACK

Basic playback procedure

Enjoying playback

- 1 Turn on the external devices (such as a TV or BD/DVD player) connected to the unit.
- 2 Use the input selection keys to select an input source.

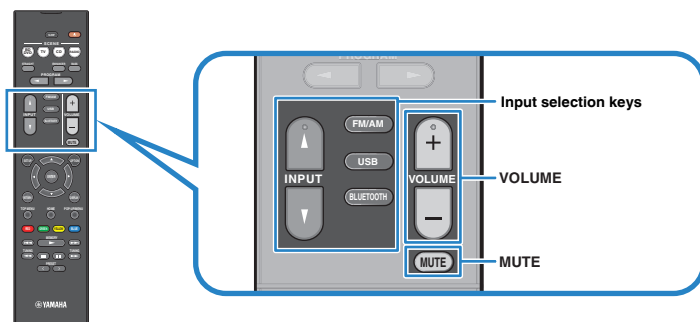

- 3 Start playback on the external device or select a radio station.

Refer to the instruction manual for the external device.

For details on the following operations, see the corresponding pages.

- “Listening to FM/AM radio” (p.37)
- “Playing back music stored on a Bluetooth® device” (p.42)
- “Playing back music stored on a USB storage device” (p.44)

- 4 Press **VOLUME** to adjust the volume.

Note

- To mute the audio output, press MUTE. Press MUTE again to unmute.
- To adjust the treble/bass settings, use the “Option” menu or TONE CONTROL on the front panel (p.48).

Switching information on the front display

- 1 Press **INFO** repeatedly to select between the various display items.



Item name

About 3 seconds after a display item is selected, its corresponding information appears.



Information

Note

Available items vary depending on the selected input source. The displayed item can also be applied separately to each input source.

Currently input source	Item
HDMI	
AV	
AUDIO	Input (input source name), DSP Program (sound mode name), Audio Decoder (decoder name*)
AUX	
Bluetooth	
USB	Song (song title), Artist (artist name), Album (album name), DSP Program (sound mode name), Audio Decoder (decoder name*)
TUNER	Frequency (frequency), DSP Program (sound mode name), Audio Decoder (decoder name*) (U.K. and Europe models only) Radio Data System data is also available when the unit is tuned into a Radio Data System broadcasting station (p.41).

* The name of the audio decoder currently activated is displayed. If no audio decoder is activated, "Decoder Off" appears.

Selecting the input source and favorite settings with one touch (SCENE)

The SCENE function allows you to select the assigned input source, sound program, and Compressed Music Enhancer on/off with just one touch.

Selecting a registered scene

1 Press SCENE.

The input source and settings registered to the corresponding scene are selected. The unit turns on automatically when it is in standby mode.

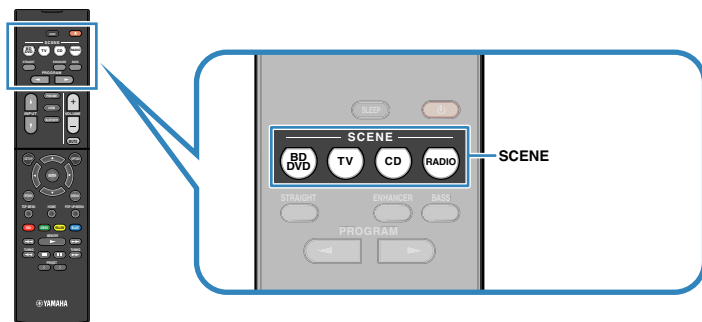

By default, the following settings are registered for each scene.

SCENE	BD DVD	TV	CD	RADIO
Input	HDMI1	AUDIO1	AUDIO2	TUNER
Sound program	MOVIE (Sci-Fi)	STRAIGHT	STRAIGHT	STEREO (5ch Stereo)
Compressed Music Enhancer	Off	On	Off	On
SCENE link playback	On	On	Off	Off

Note

The SCENE link playback function allows you to automatically turn on the TV or start playback of an external device connected to the unit via HDMI, in conjunction with a scene selection. To enable SCENE link playback, set "SCENE" (p.58) in the "Setup" menu to "On".

Registering a scene

1 Perform the following operations to prepare the settings you want to assign to a scene.

- Select an input source (p.29)
- Select a sound program (p.32) or straight decode (p.35)
- Enable/disable Compressed Music Enhancer (p.36)

2 Hold down the desired SCENE key until "SET Complete" appears on the front display.



Selecting the sound mode

The unit is equipped with a variety of sound programs and surround decoders that allow you to enjoy playback sources with your favorite sound mode (such as sound field effect or stereo playback).

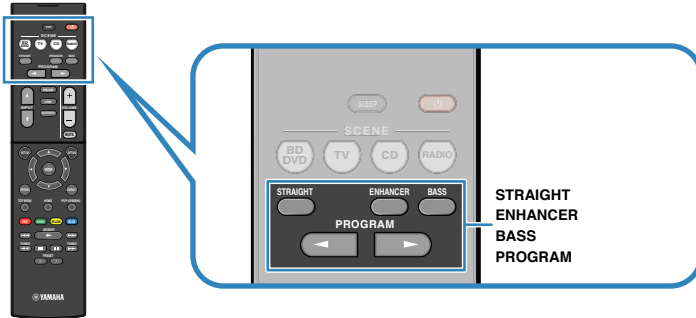

I want to enjoy listening to compressed music.

- Enable Compressed Music Enhancer by pressing ENHANCER (p.36).

This mode lets you enjoy listening to compressed music from Bluetooth devices, USB devices, etc. as it gives the music additional depth and breadth (p.36).

Note

- The sound mode can be applied separately to each input source.
- When you play back audio signals with a sampling rate of higher than 96 kHz, the straight decode mode (p.35) is automatically selected.
- You can check which speakers are currently outputting sound by looking at the speaker indicators on the unit's front panel (p.8).

I want to enjoy viewing video sources such as movies, TV programs, or games.

- Select a sound program suitable for each video source by pressing PROGRAM repeatedly (p.33).

I want to enjoy listening to music sources or stereo playback.

- Select a sound program suitable for music or stereo playback by pressing PROGRAM repeatedly (p.34).

I want to enjoy multichannel playback from 2-channel sources.

- Select a surround decoder in the "Option" menu (p.47).

I want to enjoy unprocessed sounds in original channels.

- Switch to the straight decode mode by pressing STRAIGHT (p.35).

I want to enjoy enhanced bass sounds.

- Enable Extra Bass by pressing BASS (p.36).

Enjoying sound field effects (CINEMA DSP)

CINEMA DSP

The unit is equipped with a variety of sound programs that utilize Yamaha's original DSP technology (CINEMA DSP). It allows you to easily create sound fields like actual movie theaters or concert halls in your room.

Sound program category

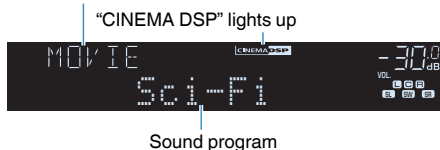

Note

You can adjust the sound field effect level in "DSP Level (DSP Level)" (p.48) in the "Option" menu.

Sound programs suitable for movies (MOVIE)

The following sound programs are optimized for viewing video sources, such as movies, TV programs, and games.

Standard	This program creates a sound field that emphasizes the surround feeling without disturbing the original acoustic positioning of multichannel audio, such as Dolby Digital and DTS. Its design is based on the concept of the ideal movie theater, in which the audience is surrounded by beautiful reverberations from the left, right, and rear.
Spectacle	This program delivers the scale and grandeur of spectacular movie productions. It delivers an expansive sound space to match the cinemascope wide-screen, and boasts a broad dynamic range, providing everything from small delicate sounds to powerful loud booms.
Sci-Fi	This program clearly reproduces the finely elaborated sound design of the latest Sci-Fi and SFX movies. You can enjoy a variety of cinematographically created virtual spaces reproduced with clear separation between dialogue, sound effects, and background music.
Adventure	This program is ideal for reproducing the sound design of action and adventure movies precisely. The sound field restrains reverberations, but puts emphasis on reproducing a sensation of expansiveness on both sides, powerful space expanded widely to the left and right. The restrained depth creates a clear and powerful space, while also maintaining the articulation of the sounds and the separation of the channels.

Drama	This program features stable reverberations that match a wide range of movie genres, from serious dramas to musicals and comedies. The reverberations are modest, but suitably stereophonic. The sound effects and background music are reproduced with a gentle echo that does not impinge on the articulation of the dialogue. You'll never get tired listening for long periods.
Mono Movie	This program reproduces monaural video sources, such as classic movies, in an atmosphere of a good old movie theater. The program creates a pleasant space with depth, by adding breadth and the appropriate reverberation to the original audio.
Sports	This program allows listeners to enjoy the rich vividness of sport broadcasts and light entertainment programs. In sports broadcasts, the commentators' voices are positioned clearly at the center, while the atmosphere inside the stadium is realistically conveyed by the peripheral delivery of the sounds of the fans in a suitable space.
Action Game	This program is suitable for action games, such as car racing and fighting games. The reality of, and emphasis on, various effects makes the player feel like they are right in the middle of the action, allowing for greater concentration. Use this program in combination with Compressed Music Enhancer for a more dynamic and strong sound field.
Roleplaying Game	This program is suitable for role-playing and adventure games. This program adds depth to the sound field for natural and realistic reproduction of background music, special effects, and dialogue from a wide variety of scenes. Use this program in combination with Compressed Music Enhancer for a clearer and more spatial sound field.

■ Sound programs suitable for music (MUSIC)

The following sound programs are optimized for listening to music sources.

Hall in Munich	This program simulates a Munich concert hall with approximately 2,500 seats that uses stylish wood for the interior finishing. Fine, beautiful reverberations spread richly, creating a calming atmosphere. The listener's virtual seat is at the center left of the arena.
Hall in Vienna	This program simulates a 1700-seat, middle-sized concert hall with a shoebox shape that is traditional in Vienna. Pillars and ornate carvings create extremely complex reverberations from all around the audience, producing a very full, rich sound.
Chamber	This program creates a relatively wide space with a high ceiling, like an audience hall in a palace. It offers pleasant reverberations that are suitable for courtly music and chamber music.
Cellar Club	This program simulates an intimate concert venue with a low ceiling and homey atmosphere. A realistic, live sound field delivers powerful sounds that make you feel as if you are sitting in the front row in front of a small stage.
The Roxy Theatre	This program creates the sound field of a 460-seat rock music concert venue in Los Angeles. The listener's virtual seat is at the center left of the hall.
The Bottom Line	This program creates the sound field at stage front in The Bottom Line, a famous New York jazz club once. The floor can seat 300 people to the left and right in a sound field offering real and vibrant sound.
Music Video	This program allows you to enjoy videos of pop, rock, and jazz concerts, as if you were there yourself. Immerse yourself in the hot concert atmosphere thanks to the vividness of the singers and solos on stage, a presence sound field that emphasizes the beat of rhythm instruments, and a surround sound field that reproduces the space of a big live hall.

■ Sound programs suitable for stereo playback (STEREO)

You can select stereo playback.

2ch Stereo	Use this program to mix down multichannel sources to 2 channels. When multichannel signals are input, they are down mixed to 2 channels and output from the front speakers (this program does not utilize CINEMA DSP).
5ch Stereo	Use this program to output sound from all speakers. When you play back multichannel sources, the unit mixes down the source to 2 channels, and then outputs the sound from all speakers. This program creates a larger sound field and is ideal for background music at parties.

■ Enjoying sound field effects without surround speakers (Virtual CINEMA DSP)

If you select one of the sound programs (except 2ch Stereo and 5ch Stereo) when no surround speakers are connected, the unit automatically creates the surround sound field using the front-side speakers.

■ Enjoying surround sound with 5 speakers placed in front (Virtual CINEMA FRONT)

You can enjoy the surround sound even when the surround speakers are placed in front.

■ Enjoying surround sound with headphones (SILENT CINEMA)

SILENT™
CINEMA

You can enjoy surround or sound field effects, like a multichannel speaker system, with stereo headphones by connecting the headphones to the PHONES jack and selecting a sound program or a surround decoder.

Enjoying unprocessed playback

You can play back input sources without any sound field effect processing.

■ Playing back in original channels (straight decode)

When the straight decode mode is enabled, the unit produces stereo sound from the front speakers for 2-channel sources such as CDs, and produces unprocessed multichannel sounds for multichannel sources.

1 Press STRAIGHT.

Each time you press the key, the straight decode mode is enabled or disabled.



■ Playing back 2-channel sources in multichannel (surround decoder)

The surround decoder enables unprocessed multichannel playback from 2-channel sources. When a multichannel source is input, it works the same way as the straight decode mode.

For details on each decoder see “Glossary” (p.77).

1 Press PROGRAM repeatedly to select a surround decoder.

The previously selected surround decoder is selected. You can change the surround decoder in “Sur.Decode” (p.47) in the “Option” menu.

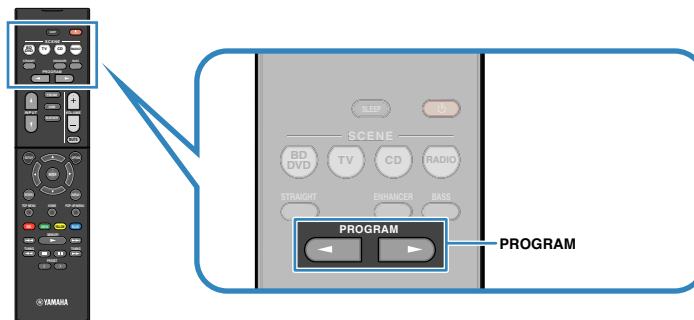

“SUR. DECODE” appears

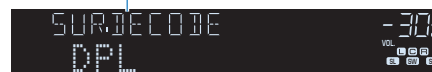

DPL	Uses the Dolby Pro Logic decoder suitable for all sources.
DPL Movie	Uses the Dolby Pro Logic II decoder suitable for movies.
DPL Music	Uses the Dolby Pro Logic II decoder suitable for music.
DPL Game	Uses the Dolby Pro Logic II decoder suitable for games.
Neo:6 Cinema	Uses the DTS Neo: 6 decoder suitable for movies.
Neo:6 Music	Uses the DTS Neo: 6 decoder suitable for music.

Note

You can adjust the surround decoder parameters in “DSP Parameter” (p.59) in the “Setup” menu.

Enhancing the bass (Extra Bass)

Extra Bass allows you to enjoy enhanced bass sounds, regardless of the size of the front speakers and the presence or absence of the subwoofer.

1 Press BASS.

Each time you press the key, Extra Bass is enabled or disabled.

Note

You can also use “Extra Bass” (p.55) in the “Setup” menu to enable/disable Extra Bass.

Playing back digitally compressed formats (such as MP3, etc.) with enriched sound (Compressed Music Enhancer)

compressed music ENHANCER

Compressed Music Enhancer adds depth and breadth to the sound, allowing you to enjoy a dynamic sound close to the original sound before it was compressed. This function can be used along with any other sound modes.

1 Press ENHANCER.

Each time you press the key, Compressed Music Enhancer is enabled or disabled.

“ENHANCER” lights up



Note

- Compressed Music Enhancer does not work on the following audio sources.
 - Signals whose sampling frequency is over 48 kHz
 - High-definition streaming audio
- You can also use “Enhancer (Enhancer)” (p.48) in the “Option” menu to enable/disable Compressed Music Enhancer.

Listening to FM/AM radio

You can tune into a radio station by specifying its frequency or selecting from registered radio stations.

Note

- The radio frequencies differ depending on the country or region where the unit is being used. The explanation of this section uses a display with frequencies used in U.K. and Europe models.
- If you cannot obtain good reception on the radio, adjust the direction of the FM/AM antennas.

Setting the frequency steps

(Asia, Taiwan, Brazil and General models only)

At the factory, the frequency step setting is set to 50 kHz for FM and 9 kHz for AM. Depending on your country or region, set the frequency steps to 100 kHz for FM and 10 kHz for AM.

- 1 Set the unit to standby mode.
- 2 When holding down STRAIGHT on the front panel, press  (power).

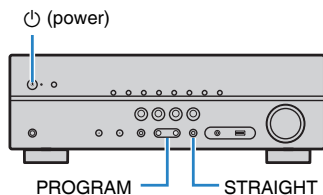

- 3 Press PROGRAM repeatedly to select "TU".



- 4 Press STRAIGHT to select "FM100/AM10".

- 5 Press  (power) to set the unit to standby mode and turn it on again.

Selecting a frequency for reception

- 1 Press FM/AM to select a band.

"TUNER" is selected as the input source and then the frequency currently selected is displayed.



2 Press TUNING repeatedly to set a frequency.

Hold down the key for about a second to search stations automatically.

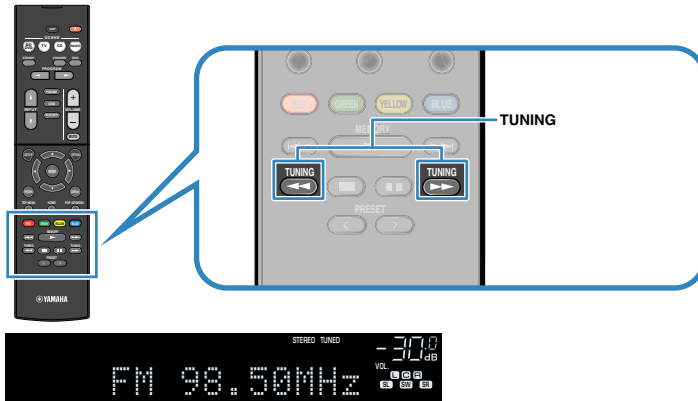

“TUNED” lights up when the unit is receiving an FM/AM radio station signal.

“STEREO” lights up when the unit is receiving a stereo FM radio signal.

Note

- You can switch between “Stereo” (stereo) and “Mono” (monaural) for FM radio reception by selecting “FM Mode” in the “Option” menu. When the signal reception for an FM radio station is unstable, switching to monaural may improve it.
- You can watch videos input from external devices while listening to radio by selecting the video input jack in “Video Out (Video Out)” (p.50) in the “Option” menu.

Registering favorite radio stations (presets)

You can register up to 40 radio stations as presets. Once you have registered stations, you can easily tune into them by selecting their preset numbers.

■ Registering radio stations automatically (Auto Preset)

Automatically register FM radio stations with strong signals (up to 40 stations).

Note

- To register AM radio stations, follow “Registering a radio station manually” (p.39).
- (U.K. and Europe models only)
Only Radio Data System broadcasting stations are registered automatically by the Auto Preset function.

1 Press FM/AM to select “TUNER” as the input source.

2 Press OPTION.

3 Use the cursor keys to select “Preset” and press ENTER.

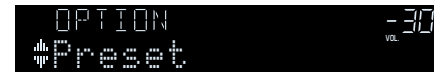

4 To start the Auto Preset process, press ENTER.

"SEARCH" appears during Auto Preset



Preset number from which to start the registration

Note

- To specify the preset number from which to start the registration, press cursor keys (</>) or PRESET to select a preset number.
- To cancel the Auto Preset process, press RETURN.

When the Auto Preset process finishes, "FINISH" appears and the "Option" menu closes automatically.



■ Registering a radio station manually

Select a radio station manually and register it to a preset number.

- 1 Follow "Selecting a frequency for reception" (p.37) to tune into the desired radio station.
- 2 Hold down MEMORY for a few seconds.

The first time that you do register a station, the selected radio station will be registered to the preset number "01". Thereafter, each radio station you select will be registered to the next empty (unused) preset number after the most recently registered number.

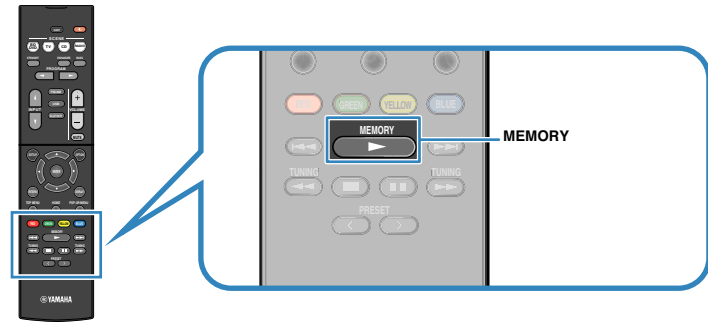

Preset number

Note

To select a preset number for registering, press MEMORY once after tuning into the desired radio station, press PRESET to select a preset number, and then press MEMORY again.



"Empty" (not in use) or the frequency currently registered

■ Selecting a preset station

Tune into a registered radio station by selecting its preset number.

- 1 Press FM/AM to select “TUNER” as the input source.
- 2 Press PRESET repeatedly to select the desired radio station.

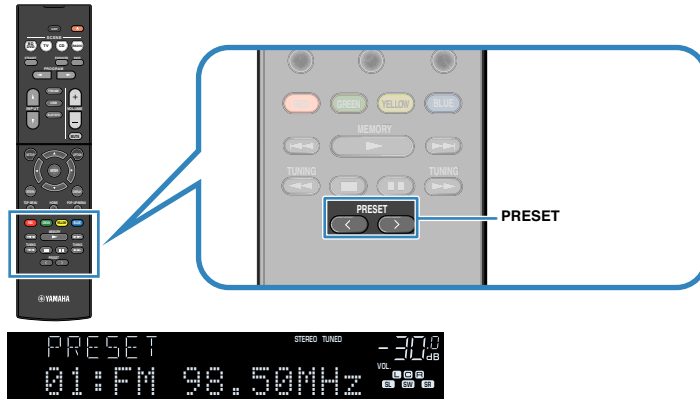

Note

“No Presets” appears when no radio stations are registered.

■ Clearing preset stations

Clear radio stations registered to the preset numbers.

- 1 Press FM/AM to select “TUNER” as the input source.
- 2 Press OPTION.
- 3 Use the cursor keys to select “Preset” and press ENTER.
- 4 Use the cursor keys (Δ/∇) to select “CLEAR”.
- 5 Use the cursor keys (\leftarrow/\rightarrow) to select a preset station to be cleared and press ENTER.

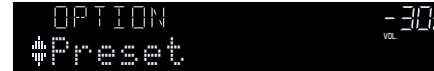

Preset station to be cleared

If the preset station is cleared, “Cleared” appears and then the next in-use preset number is displayed.



- 6 Repeat step 5 until all desired preset stations are cleared.
- 7 To exit from the menu, press OPTION.

Radio Data System tuning

(U.K. and Europe models only)

Radio Data System is a data transmission system used by FM stations in many countries. The unit can receive various types of Radio Data System data, such as "Program Service", "Program Type", "Radio Text" and "Clock Time", when it is tuned into a Radio Data System broadcasting station.

■ Displaying the Radio Data System information

1 Tune into the desired Radio Data System broadcasting station.

Note

We recommend using "Auto Preset" to tune into the Radio Data System broadcasting stations (p.38).

2 Press INFO repeatedly to select between the various display items.



Item name

About 3 seconds after a display item is selected, its corresponding information appears.



Information

Program Service	Program service name
Program Type	Current program type
Radio Text	Information on the current program
Clock Time	Current time
DSP Program	Sound mode name
Audio Decoder	Decoder name
Frequency	Frequency

Note

"Program Service", "Program Type", "Radio Text", and "Clock Time" are not displayed if the radio station does not provide the Radio Data System service.

■ Receiving traffic information automatically

When "TUNER" is selected as the input source, the unit automatically receives traffic information. To enable this function, follow the procedure below to set the traffic information station.

1 When "TUNER" is selected as the input source, press OPTION.

2 Use the cursor keys to select "Traffic Program" (TrafficProgram) and press ENTER.

The traffic information station search will start in 5 seconds. Press ENTER again to start the search immediately.

Note

- To search upward/downward from the current frequency, press the cursor keys (Δ/∇) while "READY" is displayed.
- To cancel the search, press RETURN.
- Texts in parentheses denote indicators on the front display.

The following screen appears for about 3 seconds when the search finishes.



Traffic information station (frequency)

Note

"TP Not Found" appears for about 3 seconds when no traffic information stations are found.

Playing back music stored on a Bluetooth® device

You can play back music files stored on a Bluetooth device (such as smartphones) on the unit. Also, you can enjoy audio played back on the unit using Bluetooth speakers/headphones.

Please also refer to the owner's manual of your Bluetooth device.

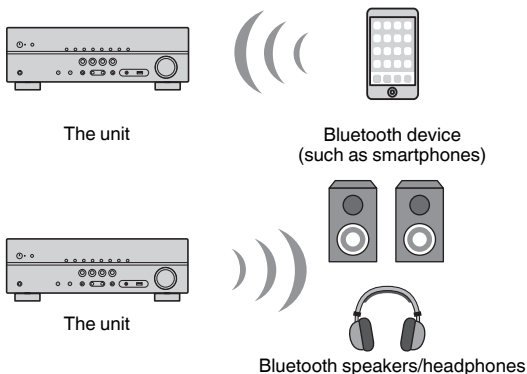

Note

- The Bluetooth device must support A2DP.
- To use the BLUETOOTH function, set "Bluetooth" (p.64) in the "Setup" menu to "On".
- You cannot make Bluetooth connections to a Bluetooth device (such as smartphones) and Bluetooth speakers/headphones at the same time.

Connecting a Bluetooth® device (pairing)

When connecting a Bluetooth device to the unit for the first time, a pairing operation is required. Pairing is an operation that registers the Bluetooth devices with each other beforehand. Once pairing has been completed, subsequent reconnection will be easy even after the Bluetooth connection is disconnected.

- 1** Press **BLUETOOTH** to select "Bluetooth" as the input source.

- 2** Hold down **MEMORY** on the front panel or the remote control for more than 3 seconds.

"Searching..." appears on the front display.

Note

- You can also use the "Option" menu to pair a Bluetooth device. Press **OPTION**, and then use the cursor keys to select "Pairing".
- If another Bluetooth device is already connected, disconnect the Bluetooth connection before you perform a pairing operation.
- To cancel pairing, press **MEMORY**.

- 3** Turn on the Bluetooth function on your device.

- 4** From the Bluetooth device list on your device, select "***** Yamaha" (*****: model name of the unit).

After pairing has been completed and the unit is connected to the Bluetooth device, "Connected" appears on the front display. While a Bluetooth connection is established, the Bluetooth indicators light up.



Note

- If you are prompted to input a passkey during a pairing procedure, input the numerals "0000".
- Complete a pairing procedure within 30 seconds.
- If no Bluetooth devices are found, "Not found" appears.

Playback of Bluetooth® device contents

Connect a paired Bluetooth device and start playback. Check the following beforehand:

- Pairing has been completed.
- Bluetooth function on the Bluetooth device is turned on.

1 Operate the Bluetooth device to establish a Bluetooth connection.

Select the model name of the unit from the Bluetooth device list on your device.

When a connection is established, the unit's input source automatically switches to "Bluetooth".

Note

- If you do not want the input source to switch automatically when a connection is established, set "Input Interlock" (p.47) to "Off" in the "Option" menu.
- You can operate the unit to search and connect the Bluetooth device (only the most recently connected device). In that case, follow one of the procedures below.
 - Switch the input source to "Bluetooth".
 - Press ENTER while the input source is "Bluetooth". Otherwise, press OPTION and use the cursor keys to select "Connect".
- If you cannot connect the device, please perform pairing again.

2 Operate the Bluetooth device to play back music.

Note

- You cannot operate the unit to select or play back music, or display informations such as song names.
- Follow one of the procedures below to disconnect a Bluetooth connection.
 - Perform the disconnect operation on the Bluetooth device.
 - Press ENTER.
 - Press OPTION and use the cursor keys to select "Disconnect".
 - Switch the unit's input source to other than "Bluetooth".
 - Press the SETUP key, then use the cursor keys to select "Bluetooth", then "Disconnect".

Enjoying audio using Bluetooth® speakers/headphones

Follow the procedure below to establish a Bluetooth connection between Bluetooth speakers/headphones and the unit.

1 Use the input selection keys on the remote control to select an input source.

Select an input source other than Bluetooth.

2 Press SETUP.

3 Use the cursor keys to select "Bluetooth" and press ENTER.

4 Use the cursor keys to set "Bluetooth" to "On", and then set "Transmitter" to "On" in the same way.

5 Use the cursor keys to select "Device Search" to search the Bluetooth devices.

The list of Bluetooth devices is displayed.

6 Select the Bluetooth speakers/headphones to be connected with the unit and press ENTER.

When the connection process finishes, audio played back on the unit will be reproduced from the Bluetooth speakers/headphones.

Note

- If the desired Bluetooth device is not displayed on the list, set the Bluetooth device to the pairing mode and then select "Device Search".
- Follow one of the procedures below to terminate the Bluetooth connection.
 - Perform the disconnect operation on the Bluetooth speakers/headphones.
 - Press the SETUP key, then use the cursor keys to select "Bluetooth", then "Transmitter", and then "Off".

Playing back music stored on a USB storage device

You can play back music files stored on a USB storage device on the unit.

Note

For details on playable USB devices, see “Supported devices and file formats” (p.79).

Connecting a USB storage device

1 Connect the USB storage device to the USB jack.

The unit (front)

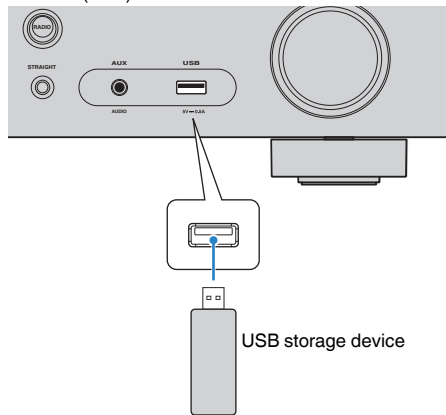

Note

- If the USB storage device contains many files, it may take time to load them. In this case, “Loading...” appears in the front display.
- Stop playback of the USB storage device before disconnect it from the USB jack.
- Connect a USB storage device directly to the USB jack of the unit. Do not use extension cables.
- The unit cannot charge USB devices while it is in standby mode.

Playback of USB storage device contents

Follow the procedure below to operate the USB storage device contents and start playback.

You can control the USB memory device with the menu displayed on the TV screen.

Note

- Operations with TV screen are available only when your TV is connected to the unit via HDMI.
- “_” (underscore) will be displayed for characters not supported by the unit.

1 Press USB to select “USB” as the input source.

The browse screen (p.45) is displayed on the TV.

Note

If playback is ongoing on your USB storage device, the playback screen is displayed.

2 Use the cursor keys to select an item and press ENTER.

If a song is selected, playback starts and the playback screen (p.45) is displayed.

Note

- To return to the previous screen, press RETURN.
- To switch the screen mode browse/playback/off, press DISPLAY.
- Files not supported by the unit cannot be selected.

Browse screen

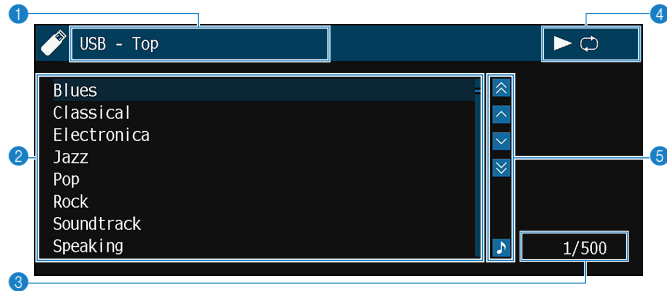

1 List name

2 Contents list

Displays the list of USB storage device contents. Use the cursor keys to select an item and press ENTER to confirm the selection.

3 Item number/total

4 Status indicators

Display the current repeat/random settings (p.46) and playback status (such as play/pause).

5 Operation menu

Press the cursor key (▷) and then use the cursor keys (△/▽) to select an item. Press ENTER to confirm the selection.

Icon	Function
	Moves 10 pages backward.
	Moves to the previous page of the list.
	Moves to the next page of the list.
	Moves 10 pages forward.
	Moves to the playback screen.

Note

A content selected by the cursor is displayed on the front display.

Playback screen

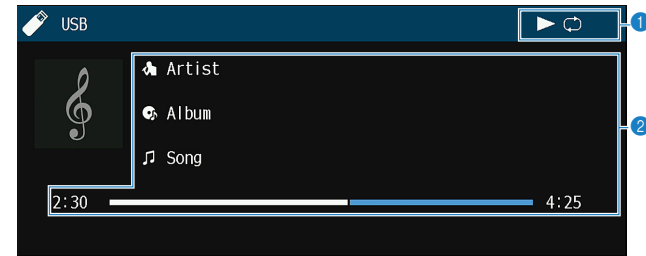

1 Status indicators

Display the current repeat/random settings (p.46) and playback status (such as play/pause).

2 Playback information

Displays the artist name, album name, song title, and elapsed time.

Use the following remote control keys to control playback.

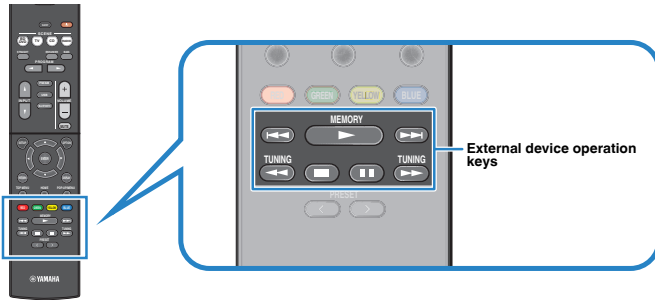

External device operation keys	Function
	Resumes playback from pause or starts playback of the previously selected song.
	Stops playback.
	Stops playback temporarily.
	Skips forward/backward.
	Searches forward/backward (by holding down).

Note

A content name of a current playback is displayed on the front display. To switch the displayed item, press INFO (p.30).

Repeat/random settings

You can configure the repeat/random settings for playback of USB storage device contents.

- 1 When “USB” is selected as the input source, press **OPTION**.
- 2 Use the cursor keys to select “Repeat” (Repeat) and press **ENTER**.

Note

- To return to the previous screen during menu operations, press RETURN.
- Texts in parentheses denote indicators on the front display.

- 3 Use the cursor keys (</>) to select a setting.

Setting	Function
Off (Off)	Turns off the repeat function.
One (One)	Plays back the current song repeatedly. “↺” appears on the TV screen.
All (All)	Plays back all songs in the current album (folder) repeatedly. “↺” appears on the TV screen.
Random (Random)	Plays back songs in random order. “⌘” appears on the TV screen.

- 4 To exit from the menu, press **OPTION**.

Configuring playback settings for different playback sources (Option menu)

You can configure separate playback settings for different playback sources. This menu is available on the front panel (or on the TV screen), allowing you to easily configure settings during playback.

1 Press OPTION.



Front display

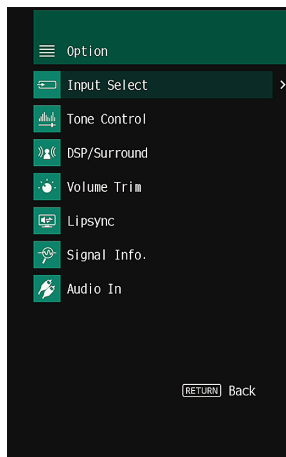

TV screen

2 Use the cursor keys to select an item and press ENTER.

Note

To return to the previous screen during menu operations, press RETURN.

3 Use the cursor keys (<|>) to select a setting.

4 To exit from the menu, press OPTION.

Option menu items

Note

- Available items vary depending on the selected input source.
- Text in parentheses denotes indicators on the front display.
- Default settings are underlined.

Item	Function	Page	
Input Select (Input Select)	Switches the input source.	p.48	
Tone Control (Tone Control)	Adjusts the level of high-frequency range and low-frequency range individually.	p.48	
DSP/Surround (DSP/Surround)	Program (PRG)	Select the sound programs and stereo playback.	p.33
	Sur.Decode (SrDec)	Select which surround decoder is used when Sur.Decode is selected as the program.	p.35
	DSP Level (DSP Level)	Adjusts the sound field effect level.	p.48
	Adaptive DRC (A.DRC)	Sets whether the dynamic range (from maximum to minimum) is automatically adjusted when the volume is adjusted.	p.48
Volume Trim (Volume Trim)	Enhancer (Enhancer)	Enables/disables Compressed Music Enhancer.	p.48
	Input Trim (In.Trim)	Corrects volume differences between input sources.	p.49
	Subwoofer Trim (SW.Trim)	Fine-adjusts the subwoofer volume.	p.49
Lipsync (Lipsync)	Enables/disables the "Lipsync" setting in the "Setup" menu.	p.49	
Signal Info. (Signal Info.)	Displays information about the video/audio signal.	p.49	
Audio In (Audio In)	Combines the video jack of the selected input source with an audio jack of others.	p.49	
Video Out (Video Out)	Selects a video to be output with the selected audio source.	p.50	
FM Mode (FM Mode)	Switches between "Stereo" and "Mono" for FM radio reception.	p.37	
Preset (Preset)	Auto Preset	Automatically registers FM radio stations with strong signals as presets.	p.38
	Clear Preset	Clear radio stations registered to preset numbers.	p.40
Traffic Program (TrafficProgram)	(U.K. and Europe models only) Automatically searches for a traffic information station.	p.41	

Item	Function	Page
Repeat (Repeat)	Configures the repeat setting for the USB storage device.	p.46
Pairing (Pairing)	Performs a pairing operation between the unit and your Bluetooth device.	p.42
Connect/Disconnect (Connect/Disconnect)	Connects/disconnects the Bluetooth device.	p.42
Input Interlock (Interlock)	Sets whether the input source automatically switches to "Bluetooth" when a Bluetooth connection is established.	p.43

Input Select (Input Select)

Switches the input source. Press ENTER to switch to the selected input source.

Tone Control (Tone Control)

Adjusts the level of high-frequency range (Treble) and low-frequency range (Bass) individually.

Choices

Treble (Treble), Bass (Bass)

Setting range

-6.0 dB to 0.0 dB to +6.0 dB (0.5 dB increments)

Note

- When both "Treble" and "Bass" are 0.0 dB, "Bypass" appears.
- You can also adjust the tone with the front panel controls. Press TONE CONTROL to select "Treble" or "Bass", then press PROGRAM to make an adjustment.
- If you set an extreme value, sounds may not match those from other channels.

DSP/Surround (DSP/Surround)

Configures the sound field program and surround settings.

DSP Level (DSP Level)

Adjusts the sound field effect level.

Setting range

-6 dB to 0 dB to +3 dB (1 dB increments)

Adaptive DRC (A.DRC)

Sets whether the dynamic range (from maximum to minimum) is automatically adjusted when the volume level is adjusted. When it is set to "On", it is useful for listening to playback at a low volume at night.

Settings

On (On)	Automatically adjusts the dynamic range.
Off (Off)	The dynamic range is not automatically adjusted.

If "On" is selected, the dynamic range becomes narrow at a low volume and wide at a high volume.

Enhancer (Enhancer)

Enables/disables Compressed Music Enhancer (p.36).

Note

- This setting is applied separately to each input source.
- You can also use ENHANCER on the remote control to enable/disable Compressed Music Enhancer (p.36).

Settings

Off (Off)	Disables Compressed Music Enhancer.
On (On)	Enables Compressed Music Enhancer.

Default

Bluetooth, USB, TUNER: On (On)

Others: Off (Off)

■ Volume Trim (Volume Trim)

Fine-adjusts volume difference between input sources or subwoofer volume.

Input Trim (In.Trim)

Corrects volume differences between input sources. If you are bothered by volume differences when switching between input sources, use this function to correct it.

Note

This setting is applied separately to each input source.

Setting range

-6.0 dB to 0.0 dB to +6.0 dB (0.5 dB increments)

Subwoofer Trim (SW.Trim)

Fine-adjusts the subwoofer volume.

Setting range

-6.0 dB to 0.0 dB to +6.0 dB (0.5 dB increments)

■ Lipsync (Lipsync)

Enables/disables the adjustment configured in "Lipsync" (p.59) in the "Setup" menu.

Note

This setting is applied separately to each input source.

Settings

Off (Off)	Disables the "Lipsync" adjustment.
On (On)	Enables the "Lipsync" adjustment.

■ Signal Info. (Signal Info.)

Displays information about the video/audio signal.

Choices

Format (FORMAT)	Audio format of the input signal
Channel (CHANNEL)	The number of source channels in the input signal (front/surround/LFE) For example, "3/2/0.1" means 3 front channels, 2 surround channels, and LFE.
Sampling (SAMPLING)	The number of samples per second of the input digital signal
Video In (VIDEO IN)	Type and resolution of the input digital signal
Video Out (VIDEO OUT)	Type and resolution of the output digital signal

Note

To switch the information on the front display, press the cursor keys (Δ/∇) repeatedly.

■ Audio In (Audio In)

Combines the video jack of the selected input source with an audio jack of others. For example, use this function in the following cases.

- Connecting a playback device that supports HDMI video output, but not HDMI audio output

Input sources

HDMI 1-4, AV 1-3

Settings

AV 1-3, AUDIO 1-2

Setup procedure

See "Changing the combination of video/audio input jacks" (p.21).

■ Video Out (Video Out)

Selects a video to be output with the selected audio source. For example, you can watch the video while listening to the radio.

Input sources

AUDIO, TUNER, USB, Bluetooth, AUX

Settings

<u>Off (Off)</u>	Does not output video.
HDMI 1-4, AV 1-3	Outputs video input through the corresponding video input jacks.

CONFIGURATIONS

Configuring various functions (Setup Menu)

You can configure the unit's various function with the menu displayed on the TV screen.

Note

Operations with TV screen are available only when your TV is connected to the unit via HDMI. If not, carry out operations while viewing the front display.

- 1 Press **SETUP**.
- 2 Use the cursor keys to select a menu and press **ENTER**.

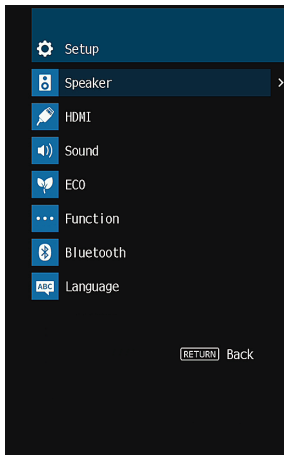

- 3 Use the cursor keys to select an item and press **ENTER**.

Note

To return to the previous screen during menu operations, press **RETURN**.

- 4 Use the cursor keys (**</>**) to select a setting and press **ENTER**.
- 5 To exit from the menu, press **SETUP**.

Setup menu items

Menu	Item	Function	Page	
Speaker	Configuration	Subwoofer	Selects whether or not a subwoofer is connected.	p.54
		Front	Selects the size of the front speakers.	p.54
		Center	Selects whether or not a center speaker is connected and its size.	p.54
		Surround	Selects whether or not surround speakers are connected and their size.	p.55
		Crossover	Sets the lower limit of the low-frequency component that can be output from speakers whose size is set to "Small".	p.55
		Subwoofer Phase	Sets the phase of the subwoofer.	p.55
		Extra Bass	Enables/disables Extra Bass.	p.55
		Virtual CINEMA FRONT	Selects whether to use the front 5-channel speaker (Virtual CINEMA FRONT) configuration.	p.55
	Distance	Sets the distance between each speaker and listening position.	p.55	
	Level	Adjusts the volume of each speaker.	p.56	
	Equalizer	Adjusts the tone with an equalizer.	p.56	
	Test Tone	Enables/disables the test tone output.	p.56	
	HDMI	HDMI Control	Enables/disables HDMI Control.	p.57
Audio Output		Enables/disables the audio output from a TV.	p.57	
4K Upscaling		Enables/disables the upscaling function.	p.57	
TV Audio Input		Selects an audio input jack of the unit to be used for TV audio input.	p.57	
Standby Sync		Selects whether to use HDMI control to link the standby behavior of the TV and the unit.	p.58	
ARC		Enables/disables ARC.	p.58	
SCENE		Enables/disables SCENE link playback.	p.58	
Sound	DSP Parameter	Panorama	Enables/disables the broadening effect of the front sound field.	p.59
		Center Width	Adjusts the broadening effect of the center sound field.	p.59
		Dimension	Adjusts the difference in level between the front and surround sound fields.	p.59
		Center Image	Adjusts the center localization (broadening effect) of the front sound field.	p.59
	Lipsync	Select	Selects the method to adjust the delay between video and audio output.	p.59
		Adjustment	Adjusts the delay between video and audio output manually.	p.60
	Dialogue	Dialogue Level	Adjusts the volume of dialogue sounds.	p.60
		Scale	Switches the scale of the volume display.	p.60
	Volume	Dynamic Range	Selects the dynamic range adjustment method for bitstream audio (Dolby Digital and DTS signals) playback.	p.60
		Max Volume	Sets the limit value of the volume.	p.60
Initial Volume		Sets the initial volume for when this receiver is turned on.	p.60	

Menu	Item	Function	Page	
ECO	Auto Power Standby	Set the amount of time for the auto-standby function.	p.61	
	ECO Mode	Enables/disables the eco mode (power saving mode).	p.61	
Function	Input Rename	Changes the input source name displayed on the front display.	p.62	
	Input Skip	Set which input source is skipped when operating the INPUT key.	p.63	
	Dimmer	Adjusts the brightness of the front display.	p.63	
	Memory Guard	Prevents accidental changes to the settings.	p.63	
	Remote Color Key	Set the unit's functions for the RED/GREEN/YELLOW/BLUE key of the remote control.	p.64	
	Bluetooth	Enables/disables the Bluetooth functions.	p.64	
Bluetooth	Audio Receive	Disconnect	Terminates the Bluetooth connection between the Bluetooth device (such as smartphones) and the unit.	p.42
		Bluetooth Standby	Selects whether to enable/disable the function that turns on the unit from Bluetooth devices (Bluetooth standby).	p.64
	Audio Send	Transmitter	Enables/disables the Bluetooth audio transmitter function.	p.65
		Device Search	Searches available Bluetooth devices (speakers/headphones) when the unit is used as a Bluetooth audio transmitter.	p.43
Language		Select an on-screen menu language.	p.65	

Speaker

Configures the speaker settings manually.

Note

Default settings are underlined.

Configuration

Configures the output characteristics of the speakers.

Note

When configuring the speaker size, as a general guideline, select "Large" if the woofer diameter of your speaker is 16 cm (6-1/4") or larger, or "Small" if it is smaller than 16 cm (6-1/4").

Subwoofer

Selects whether or not a subwoofer is connected.

Settings

	Select this option when a subwoofer is connected.
<u>Use</u>	The subwoofer will produce LFE (low-frequency effect) channel audio and low-frequency components from other channels.
	Select this option when no subwoofer is connected.
None	The front speakers will produce LFE (low-frequency effect) channel audio and low-frequency components from other channels.

Front

Selects the size of the front speakers.

Settings

	Select this option for small speakers.
<u>Small</u>	The subwoofer will produce front channel low-frequency components (configurable in "Crossover").
	Select this option for large speakers.
Large	The front speakers will produce all of the front channel frequency components.

Note

"Front" is automatically set to "Large" when "Subwoofer" is set to "None".

Center

Selects whether or not a center speaker is connected and its size.

Settings

	Select this option for small speakers.
<u>Small</u>	The subwoofer or front speakers will produce center channel low-frequency components (configurable in "Crossover").
	Select this option for large speakers.
Large	The center speaker will produce all of the center channel frequency components.
	Select this option when no center speaker is connected.
None	The front speakers will produce center channel audio.

Surround

Selects whether or not surround speakers are connected and their sizes.

Settings

	Select this option for small speakers.
<u>Small</u>	The subwoofer or front speakers will produce surround channel low-frequency components (configurable in "Crossover").
	Select this option for large speakers.
Large	The surround speakers will produce all of the surround channel frequency components.
	Select this option when no surround speakers are connected.
None	The front speakers will produce surround channel audio. Virtual CINEMA DSP works when you select a sound program.

Crossover

Sets the lower limit of the low-frequency components that can be output from a speaker whose size is set to "Small". A frequency sound lower than the specified value will be produced from the subwoofer or front speakers.

Settings

40 Hz, 60 Hz, 80 Hz, 90 Hz, 100 Hz, 110 Hz, 120 Hz, 160 Hz, 200 Hz

Note

If the volume and crossover frequency are adjustable on your subwoofer, set the volume to half and crossover frequency to maximum.

Subwoofer Phase

Sets the phase of the subwoofer. When the bass sound is lacking or unclear, switch the subwoofer phase.

Settings

<u>Normal</u>	Does not reverse the subwoofer phase.
Reverse	Reverses the subwoofer phase.

Extra Bass

Enables/disables Extra Bass. When Extra Bass is enabled, you can enjoy enhanced bass sounds, regardless of the size of the front speakers and the presence or absence of the subwoofer.

Settings

<u>Off</u>	Disables Extra Bass.
On	Enables Extra Bass.

Note

You can also use BASS on the remote control to enable/disable Extra Bass (p.36).

Virtual CINEMA FRONT

Selects whether to use the front 5-channel speaker (Virtual CINEMA FRONT) configuration.

Settings

<u>Off</u>	Disables the front 5-channel speaker configuration.
On	Enables the front 5-channel speaker configuration.

Note

- Select "On" only when utilizing the Virtual CINEMA FRONT configuration (p.13).
- This setting is not available when "Surround" is set to "None".

Distance

Sets the distance between each speaker and listening position so that sounds from the speakers reach the listening position at the same time. First, select the unit of distance from "Meter" or "Feet".

Choices

Front L, Front R, Center, Surround L, Surround R, Subwoofer

Setting range

0.30 m to 24.00 m (1.0 ft to 80.0 ft), 0.05 m (0.2 ft) increments

Default

Front L, Front R, Subwoofer: 3.00 m (10.0 ft)

Center: 2.60 m (8.6 ft)

Others: 2.40 m (8.0 ft)

■ Level

Adjusts the volume of each speaker.

Choices

Front L, Front R, Center, Surround L, Surround R, Subwoofer

Setting range

-10.0 dB to +10.0 dB (0.5 dB increments)

Default

Front L, Front R, Subwoofer: 0.0 dB

Others: -1.0 dB

■ Equalizer

Adjusts the tone with an equalizer.

EQ Select

Selects the type of equalizer to be used.

Settings

PEQ	Applies the parametric equalizer values obtained by the YPAO measurement (p.25).
GEQ	Select this option when you want to adjust the equalizer manually. For details, see "Manual equalizer adjustment".
Off	Does not use the equalizer.

Note

"PEQ" is available only when the YPAO has been performed (p.25).

■ Manual equalizer adjustment

- 1 Set "EQ Select" to "GEQ".
- 2 Use the cursor keys (Δ/∇) to select "Channel" and the cursor keys (\leftarrow/\rightarrow) to select the desired speaker channel.
- 3 Use the cursor keys (Δ/∇) to select the desired band (frequency) and the cursor keys (\leftarrow/\rightarrow) to adjust the gain.

Setting range

-6.0 dB to +6.0 dB

- 4 To exit from the menu, press SETUP.

■ Test Tone

Enables/disables the test tone output. Test tone output helps you to adjust the speaker balance or equalizer while confirming its effect.

Settings

Off	Does not output test tones.
On	Outputs test tones automatically when you adjust the speaker balance or equalizer.

HDMI

Configures the HDMI settings.

Note

Default settings are underlined.

HDMI Control

Enables/disables HDMI Control (p.80).

Settings

<u>Off</u>	Disables HDMI Control.
On	Enables HDMI Control.
On	Configure the settings in "TV Audio Input", "Standby Sync", "ARC", and "SCENE".

Note

To use HDMI control, you need to perform the HDMI Control link setup (p.80) after connecting HDMI Control-compatible devices.

Audio Output

Enables/disables the audio output from a TV connected to the HDMI OUT jack.

Settings

<u>Off</u>	Disables the audio output from the TV.
On	Enables the audio output from the TV.

Note

This setting is available only when "HDMI Control" is set to "Off".

4K Upscaling

Enables/disables the upscaling function. When it is enabled, 1080p content is displayed at 4K resolution.

Settings

<u>Off</u>	Disables the upscaling function.
On	Enables the upscaling function.

TV Audio Input

Selects an audio input jack of the unit to be used for TV audio input when "HDMI Control" is set to "On". The unit's input source automatically switches to TV audio when the TV input is switched to its built-in tuner.

Settings

AV 1-3, AUDIO 1-2

Default

AV 2

Note

When using ARC to input TV audio to the unit, you cannot use the input jacks selected here for connecting an external device because the input will be used for TV audio input.

■ Standby Sync

Select whether to use HDMI control to link the unit's standby mode to the TV's power when "HDMI Control" is set to "On".

Settings

Off	Does not set the unit to standby mode when the TV is turned off.
On	Sets the unit to standby mode when the TV is turned off.
<u>Auto</u>	Sets the unit to standby mode when the TV is turned off only when the unit is receiving TV audio or HDMI signals.

■ ARC

Enables/disables ARC (p.19) when "HDMI Control" is set to "On".

Settings

Off	Disables ARC.
<u>On</u>	Enables ARC.

Note

You do not need to change this setting normally. In case noises are produced from the speakers connected to the unit because TV audio signals input to the unit via ARC are not supported by the unit, set "ARC" to "Off" and use the TV's speakers.

■ SCENE

Enables/disable SCENE link playback when "HDMI Control" is set to "On".

When SCENE link playback is enabled, HDMI Control-compatible devices connected to the unit via HDMI automatically works as follows, with a scene selection.

- TV: turning on and displaying video from the playback device
- Playback device: starting playback

Choices (SCENE keys)

BD / DVD, TV, CD, RADIO

Settings

Off	Disables SCENE link playback for the selected SCENE key.
<u>On</u>	Enables SCENE link playback for the selected SCENE key.

Default

BD / DVD, TV: On

CD, RADIO: Off

Note

SCENE link playback may not work properly due to the compatibility between devices. We recommend using TV and playback devices from the same manufacturer so that HDMI Control works more effectively.

Sound

Configures the audio output settings.

Note

Default settings are underlined.

DSP Parameter

Configures the surround decoder settings.

Panorama

Enables/disables the broadening effect of the front sound field. When this function is enabled, you can wrap front left/right channel sounds around the sound field and generate a spacious sound field in combination with the surround sound field. This setting is effective when "DPL Music" is selected.

Settings

<u>Off</u>	Disables the broadening effect of the front sound field.
On	Enables the broadening effect of the front sound field.

Center Width

Adjusts the broadening effect of the center sound field. Higher to enhance the broadening effect, and lower to reduce it (closer to center). This setting is effective when "DPL Music" is selected.

Setting range

0 to 3 to 7

Dimension

Adjusts the difference in level between the front and surround sound fields. Higher to strengthen the front sound field and lower to strengthen the surround sound field. This setting is effective when "DPL Music" is selected.

Setting range

-3 to 0 to +3

Center Image

Adjusts the center localization (broadening effect) of the front sound field. Adjust this higher to strengthen the center localization (less broadening effect) or lower to weaken it (more broadening effect). This setting is effective when "Neo:6 Music" is selected.

Setting range

0.0 to 0.3 to 1.0

Lipsync

Adjusts the delay between video and audio output.

Note

You can enable/disable the Lipsync function by input sources in "Lipsync (Lipsync)" (p.49) in the "Option" menu.

Select

Selects the method to adjust the delay between video and audio output.

Setting range

Manual	Select this option when you want to adjust the delay between video and audio output manually. Adjust the audio output timing in "Adjustment".
<u>Auto</u>	Adjusts the delay between video and audio output automatically when a TV that supports an automatic lipsync function is connected to the unit via HDMI. If necessary, you can fine-adjust the audio output timing in "Adjustment".

Note

"Select" is automatically set to "Manual" depending on the TV connected to the unit.

Adjustment

Adjusts the delay between video and audio output manually when "Select" is set to "Manual". You can fine-adjust the audio output timing when "Select" is set to "Auto".

Setting range

0 ms to 500 ms (1 ms increments)

Dialogue

Adjusts the volume of dialogue sounds.

Dialogue Level

Adjusts the volume of the center orientation sounds such as dialogue.

Setting range

0 to 3 (higher to strengthen)

Volume

Configures the volume settings.

Scale

Switches the scale of the volume display.

Settings

dB	Displays the volume in the "dB" unit.
0-97	Displays the volume in the numeric value (0.5 to 97.0).

Dynamic Range

Selects the dynamic range adjustment method for bitstream audio (Dolby Digital and DTS signals) playback.

Settings

Maximum	Produces audio without adjusting the dynamic range.
Standard	Optimizes the dynamic range for regular home use.
Min/Auto	Sets the dynamic range for clear sound even at night or at low volumes. When playing back Dolby TrueHD signals, the dynamic range is automatically adjusted based on the input signal information.

Max Volume

Sets the limit value of the volume.

Setting range

-30.0 dB to +15.0 dB (5.0 dB increments), +16.5 dB [50.0 to 95.0 (5.0 increments), 97.0]

Initial Volume

Sets the initial volume when the receiver is turned on.

Settings

Off	Sets the level to the volume level of the unit when it last entered standby mode.
Mute	Sets the unit to mute the audio output.
-80.0 dB to +16.5 dB (0.5 dB increments) [0.5 to 97.0 (0.5 increments)]	Sets the level to the specified volume level.

ECO

Configures the power supply settings.

Note

Default settings are underlined.

■ Auto Power Standby

Set the amount of time for the auto-standby function.

Settings

<u>Off</u>	Does not set the unit to standby mode automatically.
20 minutes	Sets the unit to standby mode when you have not operated the unit and the unit has not detected any input signal for the specified time.
2 hours, 4 hours, 8 hours, 12 hours	Sets the unit to standby mode when you have not operated the unit for the specified time.

Default

U.K. and Europe models: 20 minutes

Other models: Off

Note

Just before the unit enters standby mode, "AutoPowerStdby" appears and then countdown starts in the front display.

■ ECO Mode

You can reduce the unit's power consumption by setting the eco mode to "On". After setting, be sure to press ENTER to restart the unit.

When the eco mode is enabled, you can reduce the unit's power consumption.

Settings

<u>Off</u>	Disables the eco mode.
On	Enables the eco mode.

Note

- When "ECO Mode" is set to "On", the front panel display may become dark.
- If you want to play audio at high volume, set "ECO Mode" to "Off".

Function

Configures the functions that make the unit easier to use.

Note

Default settings are underlined>.

Input Rename

Changes the input source name displayed on the front display. You can also select a name created by the Auto Rename function.

Input sources

HDMI 1-4, AUDIO 1-2, AV 1-3, USB, Bluetooth, AUX

Default

HDMI 1-4: Auto

Others: Manual (For USB, Bluetooth, AUX only "Manual" can be selected.)

Procedure to rename automatically

1 Use the cursor keys (Δ/∇) to select an input source to be renamed.

2 Use the cursor keys ($\triangleleft/\triangleright$) to select "Auto".

The unit creates a name automatically according to the connected device.

3 To change another input source, repeat steps 1 to 2.

4 To exit from the menu, press SETUP.

Note

During selecting "Auto", the created name is saved even after the device connection is terminated. To reset to the default setting, switch the setting to "Manual" at once and then set it again to "Auto".

Procedure to rename manually

1 Use the cursor keys (Δ/∇) to select an input source to be renamed.

2 Use the cursor keys ($\triangleleft/\triangleright$) to select "Manual" and press ENTER.

The edit screen is displayed.

3 Use the cursor keys and ENTER key to edit the name, and then select "OK" and press ENTER.

Note

- To cancel the entry, select "CANCEL".
- If you select "RESET", the default input name will be inserted into the editing area.

4 To change another input source name, repeat steps 1 to 4.

5 To exit from the menu, press SETUP.

■ Input Skip

Set which input source is skipped when operating the INPUT key.
You can select the desired input source quickly by using this function.

Input sources

HDMI 1-4, AUDIO 1-2, AV 1-3, TUNER, USB, Bluetooth, AUX

Settings

<u>Off</u>	Does not skip the selected input source.
On	Skips the selected input source.

■ Dimmer

Adjusts the brightness of the front display.

Setting range

-4 to 0 (higher to brighten)

Note

The front display may become dark when "ECO Mode" (p.61) is set to "On".

■ Memory Guard

Prevents accidental changes to the settings.

Settings

<u>Off</u>	Does not protect the settings.
On	Protects the settings until "Off" is selected.

Note

When "Memory Guard" is set to "On", the lock icon (🔒) is displayed on the menu screen.

Remote Color Key

Set the unit's functions for the RED/GREEN/YELLOW/BLUE key of the remote control.

Settings

Default	Assigns the functions of playback devices connected to the unit with an HDMI cable.
Input	<p>Assigns the unit's input sources to each key. The assigned input sources can be set separately.</p> <p>Input sources</p> <p>HDMI 1-4, AUDIO 1-2, AV 1-3, TUNER, USB, Bluetooth, AUX</p> <p>Default</p> <p>RED: HDMI2, GREEN: HDMI4, YELLOW: AV 2, BLUE: AUX</p>
Program	<p>Assigns the functions of sound mode to each key.</p> <p>RED: MOVIE GREEN: MUSIC YELLOW: STEREO BLUE: SUR.DECODE</p> <p>For example, if you press the RED key repeatedly, you can select your favorite sound program from the sound programs (MOVIE) (p.33) suitable for the video source.</p>

Bluetooth

Configures the Bluetooth settings.

Bluetooth

Enables/disables the Bluetooth function (p.42).

Settings

Off	Disables the Bluetooth function.
<u>On</u>	Enables the Bluetooth function.

Audio Receive

Configures the Bluetooth settings when the unit is used as the Bluetooth audio receiver.

Bluetooth Standby

Selects whether to enable/disable the function that turns on the unit from Bluetooth devices (Bluetooth standby). If this function is set to "On", the unit automatically turns on when a connect operation is performed on the Bluetooth device.

Settings

Off	Disables the Bluetooth standby function.
<u>On</u>	Enables the Bluetooth standby function. (The unit consumes more power than when "Off" is selected.)

Audio Send

Configures the Bluetooth settings when the unit is used as the Bluetooth audio transmitter.

Transmitter

Enables/disables the Bluetooth audio transmitter function.

When this function is enabled, you can enjoy audio played back on the unit using Bluetooth speakers/headphones (p.43).

Settings

<u>Off</u>	Disables the Bluetooth audio transmitter function.
On	Enables the Bluetooth audio transmitter function.

Language

Select an on-screen menu language.

Note

Default settings are underlined.

Settings

<u>English</u>	English
日本語	Japanese
Français	French
Deutsch	German
Español	Spanish
Русский	Russian
Italiano	Italian
中文	Chinese

Note

The information on the front display is provided in English only.

Configuring the system settings (ADVANCED SETUP menu)

Configure the system settings of the unit while viewing the front display.

- 1 Set the unit to standby mode.
- 2 While holding down STRAIGHT on the front panel, press $\text{\textcircled{P}}$ (power).

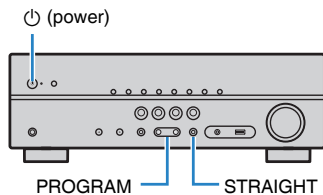

- 3 Press PROGRAM to select an item.
- 4 Press STRAIGHT to select a setting.
- 5 Press $\text{\textcircled{P}}$ (power) to set the unit to standby mode and turn it on again.

The new settings take effect.

ADVANCED SETUP menu items

Note

Default settings are underlined.

Item	Function	Page
SP IMP.	(U.S.A. and Canada models only) Changes the speaker impedance setting.	p.66
REMOTE ID	Selects the unit's remote control ID.	p.67
TU	(Asia, Taiwan and General models only) Changes the FM/AM tuning frequency setting.	p.67
TV FORMAT	Switches the video signal type of HDMI output.	p.67
4K MODE	Selects the HDMI 4K signal format.	p.68
INIT	Restores the default settings.	p.68
UPDATE	Updates the firmware.	p.68
VERSION	Checks the version of firmware currently installed on the unit.	p.68

Changing the speaker impedance setting (SP IMP.)

(U.S.A. and Canada models only)



Change the unit's speaker impedance settings depending on the impedance of the speakers connected.

Settings

<u>6 Ω MIN</u>	Select this option when you connect 6-ohm speakers to the unit.
<u>8 Ω MIN</u>	Select this option when you connect 8-ohm or higher speakers to the unit.

Selecting the remote control ID (REMOTE ID)

REMOTE ID • ID1

Change the unit's remote control ID so that it matches the remote control's ID (default: ID1). When using multiple Yamaha AV receivers, you can set each remote control with a unique remote control ID for its corresponding receiver.

Settings

ID1, ID2

■ Changing the remote control ID of the remote control

- 1 To select ID1, while holding down the cursor key (◀), hold down SCENE (BD/DVD) for more than 3 seconds.
To select ID2, while holding down the cursor key (◀), hold down SCENE (TV) for more than 3 seconds.**

Changing the FM/AM tuning frequency setting (TU)

(Asia, Taiwan and General models only)

TU • • • FM50/AM9

Change the FM/AM tuning frequency setting of the unit depending on your country or region.

Settings

FM100/AM10	Select this when you want to adjust the FM frequency by 100-kHz steps and AM by 10-kHz steps.
FM50/AM9	Select this when you want to adjust the FM frequency by 50-kHz steps and AM by 9-kHz steps.

Switching the video signal type (TV FORMAT)

TV FORMAT • NTSC

Switch the video signal type of HDMI output so that it matches to the format of your TV.

Since the unit automatically selects the video signal type so that it matches to the TV, it is unnecessary to change the setting normally. Change the setting only when images on the TV screen do not appear correctly.

Settings

NTSC, PAL

Default

U.S.A., Canada, Korea, Taiwan and General models: NTSC

Other models: PAL

Selecting the HDMI 4K signal format (4K MODE)

4K MODE • MODE 1

Selects the format of signals input/output at the unit when HDMI 4K compatible TV and playback device are connected to the unit.

Settings

MODE 1	Inputs/outputs 4K signals shown in the table below. Depending on the connected device or HDMI cables, video may not be displayed correctly. In this case, select "MODE 2".
MODE 2	Inputs/outputs 4K signals shown in the table below.

Note

When "MODE 1" is selected, use a Premium High Speed HDMI Cable or Premium High Speed Cable with Ethernet.

Format

		MODE 1			MODE 2		
		8 bit	10 bit	12 bit	8 bit	10 bit	12 bit
4K/60, 50 Hz	RGB 4:4:4	✓	–	–	–	–	–
	YCbCr 4:4:4	✓	–	–	–	–	–
	YCbCr 4:2:2	–	✓	–	–	–	–
	YCbCr 4:2:0	–	✓	–	✓	–	–
4K/30, 25, 24 Hz	RGB 4:4:4	–	✓	–	✓	–	–
	YCbCr 4:4:4	–	✓	–	✓	–	–
	YCbCr 4:2:2	–	✓	–	–	✓	–

Restoring the default settings (INIT)

INIT • • • • CANCEL

Restores the default settings for the unit.

Choices

ALL	Restores the default settings for the unit.
CANCEL	Does not perform an initialization.

Updating the firmware (UPDATE)

UPDATE • • • • • USB

New firmware that provides additional features or product improvements will be released as needed. Updates can be downloaded from our website. For details, refer to the information supplied with updates.

Firmware update procedure

Do not perform this procedure unless firmware update is necessary. Also, make sure you read the information supplied with updates before updating the firmware.

- 1 Save the downloaded firmware to the root folder of a USB memory device.
- 2 Press PROGRAM on the front panel to select "UPDATE".
- 3 Connect the USB memory device to the USB jack.
- 4 To start firmware update, press INFO on the front panel.

Checking the firmware version (VERSION)

VERSION • • xx.xx

Check the version of firmware currently installed on the unit.

Note

It may take a while until the firmware version is displayed.

APPENDIX

Frequently asked questions

The frequently asked questions from customers and the answers are shown below.

The new speaker system does not provide an ideal sound balance...

If you have changed speakers or have a new speaker system, use YPAO to optimize the speaker settings again (p.25). If you want to adjust the speaker settings manually, use "Speaker" in the "Setup" menu (p.54).

We want to set limitations on the volume control...

If someone accidentally operates the controls on the main unit or remote control, the volume may suddenly increase. This may also cause injury or damage the unit or speakers. We recommend using "Max Volume" in the "Setup" menu to set the maximum volume level for the unit in advance (p.60).

I want to fix the volume when turning on the unit...

By default, the volume level when the unit last entered standby mode is automatically applied. If you want to fix the volume, use "Initial Volume" in the "Setup" menu to set the volume to be applied when the receiver is turned on (p.60).

The volume varies depending on the input sources...

You can correct volume differences between input sources by utilizing "Input Trim" in the "Option" menu (p.49).

HDMI Control does not work at all...

To use HDMI Control, you need to perform the HDMI Control link setup (p.80). After connecting HDMI Control-compatible devices (such as BD/DVD players) to the unit, enable HDMI Control on each device and perform the HDMI Control link setup. This setup is required every time you add a new HDMI Control-compatible device to your system. For information on how HDMI Control works between your TV and playback devices, refer to the instruction manuals for each device.

I want to change the input source name...

By default, input source names (such as "HDMI1" and "AV 1") are displayed on the front display when an input source is selected. If you want to rename them as you like, use "Input Rename" (p.62) in the "Setup" menu.

I want to prevent accidental changes to the settings...

You can protect the settings configured on the unit (such as speaker settings) by utilizing "Memory Guard" in the "Setup" menu (p.63).

The unit's remote control is simultaneously controlling another Yamaha product as well as the unit...

When using multiple Yamaha products, the remote control may work on another Yamaha product or another remote control may work on the unit. If this happens, register different remote control IDs for the devices that you want to control with each remote control (p.67).

The combination of video/audio input jacks does not match an external device...

Use "Audio In" in the "Option" menu to change the combination of video/audio input jacks so that it matches the output jack(s) of your external device (p.21).

Video and audio are not synchronized...

Use "Lipsync" in the "Setup" menu to adjust the delay between video and audio output (p.59).

I want to hear audio from the TV speakers...

Use "Audio Output" in the "Setup" menu to enable audio output from the TV speakers (p.57).

I want to change the on-screen menu language...

Use "Language" in the "Setup" menu to select a language from English, Japanese, French, German, Spanish, Russian, Italian and Chinese (p.24).

I want to update the firmware...

Use "UPDATE" in the "ADVANCED SETUP" menu to update the unit's firmware (p.68).

Troubleshooting

Refer to the table below when the unit does not function properly.

If the problem you are experiencing is not listed below or if the instructions below do not help, turn off the unit, disconnect the power cable, and contact the nearest authorized Yamaha dealer or service center.

First, check the following:

- 1** The power cables of the unit, TV and playback devices (such as BD/DVD players) are connected to AC wall outlets securely.
- 2** The unit, subwoofer, TV and playback devices (such as BD/DVD players) are turned on.
- 3** The connectors of each cable are securely inserted in to jacks on each device.

Power, system and remote control

Problem	Cause	Remedy
The power does not turn on.	The protection circuitry has been activated three times consecutively. If the unit is in this condition, the standby indicator on the unit blinks when you try to turn on the power.	As a safety precaution, capability to turn on the power is disabled. Contact your nearest Yamaha dealer or service center to request repair.
The power does not turn off.	The internal microcomputer has frozen, due to an external electric shock (such as lightning or excessive static electricity) or to a drop in the power supply voltage.	Hold down ⏻ (power) on the front panel for more than 15 seconds to reboot the unit. (If the problem persists, disconnect the power cable from the AC wall outlet and plug it again.)
The power turns off (standby mode) immediately.	The unit was turned on while a speaker cable was shorted.	Twist the bare wires of each speaker cable firmly and reconnect to the unit and speakers (p.17).
The unit enters standby mode automatically.	The sleep timer worked.	Turn on the unit and start playback again.
	The auto-standby function activated because the unit was not used for the specified time.	To disable the auto-standby function, set "Auto Power Standby" in the "Setup" menu to "Off" (p.61).
	The speaker impedance setting is incorrect.	Set the speaker impedance to match your speakers (p.66).
The unit is not reacting.	The protection circuitry has been activated because of a short circuit.	Twist the bare wires of each speaker cable firmly and reconnect to the unit and speakers (p.17).
	The internal microcomputer is frozen, due to an external electric shock (such as lightning or excessive static electricity) or to a drop in the power supply voltage.	Hold down ⏻ (power) on the front panel for more than 15 seconds to reboot the unit. (If the problem persists, disconnect the power cable from the AC wall outlet and plug it again.)

Problem	Cause	Remedy
The unit cannot be controlled using the remote control.	The unit is out of the operating range.	Use the remote control within the operating range (p.4).
	The batteries are weak.	Replace with new batteries.
	The unit's remote control sensor is exposed to direct sunlight or strong lighting.	Adjust the lighting angle, or reposition the unit.
	The remote control IDs of the unit and the remote control are not identical.	Change the remote control ID of the unit or the remote control (p.67).
Cannot select the desired input source even if "INPUT" is pressed.	The function which skips some input sources is set.	Set "Input Skip" of the desired input source in the "Setup" menu to "Off" (p.63).
The RED/GREEN/YELLOW/BLUE keys of the remote control do not operate.	The device which is connected to the unit via HDMI does not support the operation of the RED/GREEN/YELLOW/BLUE keys.	Use a device which supports the operation of the RED/GREEN/YELLOW/BLUE keys.
	The settings of the RED/GREEN/YELLOW/BLUE keys of the unit's remote control have been changed.	Set the "Remote Color Key" settings in the "Setup" menu to "Default" (p.64).

Audio

Problem	Cause	Remedy
No sound.	Another input source is selected.	Select an appropriate input source with the input selection keys.
	Signals that the unit cannot reproduce are being input.	Some digital audio formats cannot be played back on the unit. To check the audio format of the input signal, use "Signal Info." in the "Option" menu (p.49).
	The cable connecting the unit and playback device is defective.	If there is no problem with the connection, replace with another cable.
The volume cannot be increased.	The maximum volume is set.	Use "Max Volume" in the "Setup" menu to adjust the maximum volume (p.60).
	A device connected to the output jacks of the unit is not turned on.	Turn on all devices connected to the output jacks of the unit.
No sound is coming from a specific speaker.	The playback source does not contain a signal for the channel.	To check it, use "Signal Info." in the "Option" menu (p.49).
	The currently selected sound program/decoder does not use the speaker.	To check it, select "5ch Stereo" (p.32).
	Audio output of the speaker is disabled.	Perform YPAO (p.25) or use "Configuration" in the "Setup" menu to change the speaker settings (p.54).
	The volume of the speaker is set too low.	Perform YPAO (p.25) or use "Level" in the "Setup" menu to adjust the speaker volume (p.56).
	The speaker cable connecting the unit and the speaker is defective.	If there is no problem with the connection, replace with another speaker cable.
	The speaker is malfunctioning.	To check it, replace with another speaker. If the problem persists, the unit may be malfunctioning.

Problem	Cause	Remedy
No sound is coming from the subwoofer.	The playback source does not contain Low Frequency Effect (LFE) or low-frequency signals.	To check it, set "Extra Bass" in the "Setup" menu to "On", in order to output the front channel low-frequency components from the subwoofer (p.55).
	Subwoofer output is disabled.	Perform YPAO (p.25) or set "Subwoofer" in the "Setup" menu to "Use" (p.54).
	The volume of the subwoofer is too low.	Adjust the volume on the subwoofer.
	The subwoofer has been turned off by its auto-standby function.	Disable the auto-standby function of the subwoofer or adjust its sensitivity level.
No sound from the playback device (connected to the unit with HDMI).	The TV does not support HDCP (High-bandwidth Digital Content Protection).	Refer to the instruction manuals for the TV and check the TV's specifications.
	The number of devices connected to the HDMI OUT jack exceeds the limit.	Disconnect some of the HDMI devices.
No sound from the TV (when HDMI Control is used).	The TV is set to output audio from the TV speakers.	Change the audio output setting on your TV so that the TV audio is output from the speakers connected to the unit.
	A TV that does not support ARC is connected to the unit only with an HDMI cable.	Use a digital optical cable to make an audio connection (p.19).
	(If the TV is connected to the unit with an audio cable) The TV audio input setting does not match the actual connection.	Use "TV Audio Input" in the "Setup" menu to select the correct audio input jack (p.57).
	(If you are trying to use ARC) ARC is disabled on the unit or TV.	Set "ARC" in the "Setup" menu to "On" (p.58). Also, enable ARC on the TV.
When playing back DSD audio, the unit disables the audio output from a TV.	The unit does not support DSD audio output from a TV.	Change the audio output setting on the playback device to PCM.
Only the front speakers work on multichannel audio.	The playback device is set to output 2-channel audio (such as PCM) only.	To check it, use "Signal Info." in the "Option" menu (p.49). If necessary, change the digital audio output setting on the playback device.
Noise/hum is heard.	The unit is too close to another digital or radio frequency device.	Move the unit further away from the device.
	The cable connecting the unit and playback device is defective.	If there is no problem with the connection, replace with another cable.
The sound is distorted.	The volume of the unit is too high.	Turn down the volume. If "ECO Mode" in the "Setup" menu is set to "On", set it to "Off" (p.61).
	A device connected to the unit's output jacks is not turned on.	Turn on all devices connected to the unit's output jacks.

Video

Problem	Cause	Remedy
No video.	Another input source is selected on the unit.	Select an appropriate input source with the input selection keys.
	Another input source is selected on the TV.	Switch the TV input to display the video from the unit.
	The video signal output from the unit is not supported by the TV.	Check the video output setting of the playback device. For information about video signals supported by the TV, refer to the instruction manuals for the TV.
	The cable connecting the unit and TV (or playback device) is defective.	If there is no problem with the connection, replace with another cable.
No video from the playback device (connected to the unit with HDMI).	The input video signal (resolution) is not supported by the unit.	To check the information about the current video signal (resolution), use "Signal Info." in the "Option" menu (p.49). For information about video signals supported by the unit, see "HDMI signal compatibility" (p.82).
	The TV does not support HDCP (High-bandwidth Digital Content Protection).	Refer to the instruction manuals for the TV and check the TV's specifications.
	The number of devices connected to the HDMI OUT jack is over the limit.	Disconnect some of the HDMI devices.
No image (contents required the HDCP 2.2 - compatible HDMI device) from the playback device connected to the unit with HDMI.	The TV (HDMI input jack) does not support HDCP 2.2. (The Warning message can be displayed on the TV screen.)	Connect the unit to the TV (HDMI input jack) that supports HDCP 2.2.
The menu of the unit is not displayed on the TV.	The TV is not connected to the unit via HDMI.	You can display the menu of the unit on the TV only when they are connected with an HDMI cable. If necessary, use an HDMI cable to connect them (p.19 to p.20).
	Another input source is selected on the TV.	Switch the TV input to display the video from the unit (HDMI OUT jack).

FM/AM radio

Problem	Cause	Remedy
FM radio reception is weak or noisy.	There is multi-path interference.	Adjust the FM antenna height or orientation, or place it in a different location.
	Your area is too far from the FM station transmitter.	To select monaural FM radio reception "FM Mode" in the "Option" menu to "Mono" (p.37). Use an outdoor FM antenna.
AM radio reception is weak or noisy.	The noises may be caused by fluorescent lamps, motors, thermostats, or other electrical equipment.	It is difficult to completely eliminate noise. It may be reduced by using an outdoor AM antenna.
Radio stations cannot be selected automatically.	Your area is too far from the FM station transmitter.	Select the station manually (p.37). Use an outdoor antenna. We recommend using a sensitive multi-element antenna.
	The AM radio signal is weak.	Adjust the AM antenna orientation. Select the station manually (p.37). Use an outdoor AM antenna. Connect it to the ANTENNA (AM) jack together with the supplied AM antenna.
AM radio stations cannot be registered as presets.	Auto Preset has been used.	Auto Preset is for registering FM radio stations only. Register AM radio stations manually (p.38).

USB

Problem	Cause	Remedy
The unit does not detect the USB device.	The USB device is not connected to the USB jack securely.	Turn off the unit, reconnect your USB device, and turn the unit on again.
	The file system of the USB device is not FAT 16 or FAT 32.	Use a USB device with FAT 16 or FAT 32 format, except USB HDDs.
Folders and files in the USB device cannot be viewed.	The folder structure not supported by the unit is applied.	The unit supports folder hierarchies of up to eight levels and up to 65,000 files per level. If necessary, modify the folder structure on your USB device.

Bluetooth®

Problem	Cause	Remedy
Cannot make the unit pair with a Bluetooth device.	Another Bluetooth device is connected.	Terminate current Bluetooth connection, and perform pairing with the new device.
	This unit and the device are too far apart.	Move the device closer to this unit.
	There is a device (microwave oven, wireless LAN, etc.) that outputs signals in the 2.4 GHz frequency band nearby.	Move this unit away from the device that is emitting radio-frequency signals.
	The Bluetooth device does not support A2DP.	Perform pairing with a device which supports A2DP.
Cannot make a Bluetooth connection.	Another Bluetooth device is connected.	Terminate current Bluetooth connection, then establish a Bluetooth connection with that device again.
	The Bluetooth function of the device is turned off.	Turn on the Bluetooth function of the device.
	The pairing information has been deleted.	Delete the pairing information on the device, and then perform pairing again (p.42). This unit can be paired with sixteen devices. If pairing with a seventeenth device is performed, the pairing information with the earliest connection date will be deleted.
	The pairing information is removed from/not registered on the Bluetooth connection list.	Perform pairing again (p.42).
No sound is produced, or the sound is interrupted during playback.	The volume of the connecting device is set too low.	Turn up the volume of the connecting device.
	The connecting device is not set to send Bluetooth audio signals to the unit.	Switch the output of Bluetooth audio signals of the connecting device to the unit.
	The Bluetooth connection of the unit with the device has terminated.	Perform Bluetooth connection operations again (p.42).
	There is a device (microwave oven, wireless LAN, etc.) that outputs signals in the 2.4 GHz frequency band nearby.	Move this unit away from the device that is emitting radio-frequency signals.
	This unit and the connecting device are too far apart.	Move the connecting device closer to this unit.

Error indications on the front display

Refer to the table below when the error message is indicated on the front display.

Message	Cause	Remedy
Access error	The unit cannot access the USB device.	Turn off the unit and reconnect your USB device. If the problem persists, try another USB device.
Check SP Wires	The speaker cables short circuit.	Twist the bare wires of the cables firmly and connect to the unit and speakers properly.
Internal Error	An internal error has occurred.	Contact the nearest authorized Yamaha dealer or service center.
No content	There are no playable files in the selected folder.	Select a folder that contains files supported by the unit.
Not found	The Bluetooth device is not found.	<ul style="list-style-type: none">• Place the Bluetooth device within 10 m (32 ft) of the Bluetooth receiver.• Perform pairing again.
RemID Mismatch	The remote control IDs of the unit and the remote control are not identical.	Change the remote control ID of the unit or the remote control (p.67).

This is a glossary of the technical terms used in this manual.

Audio information

Audio decoding format

Dolby Digital

Dolby Digital is a compressed digital audio format developed by Dolby Laboratories, Inc. that supports 5.1-channel audio. This technology is used for audio on most DVD disc.

Dolby Pro Logic II

Dolby Pro Logic II enables 5-channel playback from 2-channel sources. There are three modes available: "Music mode" for music sources, "Movie mode" for movie sources, and "Game mode" for game sources.

Dolby TrueHD

Dolby TrueHD is an advanced lossless audio format developed by Dolby Laboratories, Inc. to offer a high-definition home theater experience with the quality of the studio master. Dolby TrueHD can carry up to eight channels of 96 kHz/24-bit audio (up to six channels of 192 kHz/24-bit audio) simultaneously. This technology is used for audio on BD (Blu-ray Disc).

DTS 96/24

DTS 96/24 is a compressed digital audio format that supports 5.1-channel and 96 kHz/24-bit audio. This format remains fully compatible with the existing multichannel audio systems that support DTS Digital Surround. This technology is used for music DVDs, etc.

DTS Digital Surround

DTS Digital Surround is a compressed digital audio format developed by DTS, Inc. that supports 5.1-channel audio. This technology is used for audio on most DVD discs.

DTS Express

DTS Express is a compressed digital audio format that supports 5.1-channel audio and allows a higher compression rate than the DTS Digital Surround format developed by DTS, Inc. This technology is developed for audio streaming services on the Internet and secondary audio on BD (Blu-ray Disc).

DTS-HD High Resolution Audio

DTS-HD High Resolution Audio is a compressed digital audio format developed by DTS, Inc. that supports 7.1-channel and 96 kHz/24-bit audio. DTS-HD High Resolution Audio remains fully compatible with the existing multichannel audio systems that support DTS Digital Surround. This technology is used for audio on most BD (Blu-ray Disc).

DTS-HD Master Audio

DTS-HD Master Audio is an advanced lossless audio format developed to offer a high-definition home theater experience with the quality of the studio master by DTS, Inc. DTS-HD Master Audio can carry up to eight channels of 96 kHz/24-bit audio (up to six channels of 192 kHz/24-bit audio) simultaneously. This technology is used for audio on BD (Blu-ray Disc).

DTS Neo: 6

DTS Neo: 6 enables 6-channel playback from 2-channel sources. There are two modes available: "Music mode" for music sources and "Cinema mode" for movie sources. This technology provides discrete full-bandwidth matrix channels of surround sound.

DSD (Direct Stream Digital)

DSD (Direct Stream Digital) technology stores audio signals on digital storage media, such as SACD (Super Audio CDs). The signals are stored at a high-frequency sampling rate of 2.8224 MHz. The highest frequency response is equal to or higher than 100 kHz, with a dynamic range of 120 dB. This technology offers better audio quality than that used for CDs.

MP3

One of the compressed digital audio format used by MPEG. With psychoacoustic technologies, this compression method achieves a high compression rate. Reportedly, it is capable of compressing data quantity by about 1/10 maintaining a certain level of audio quality.

MPEG-4 AAC

An MPEG-4 audio standard. It is used for mobile telephones, portable audio players, and audio streaming services on Internet because it allows a high compression rate of data while maintaining better audio quality than MP3.

PCM (Pulse Code Modulation)

PCM is a signal format under which an analog audio signal is digitized, recorded, and transmitted. This technology is the basis of all other audio format. This technology is used as a lossless audio format called Linear PCM for audio on a variety of media, including CDs and BD (Blu-ray Disc).

Sampling frequency/Quantization bit

Sampling frequency and quantization bits indicate the quantity of information when an analog audio signal is digitized. These values are noted as in the following example: "48 kHz/24-bit".

- Sampling frequency
Sampling frequency (the number of times the signal is sampled per second) is called the sampling rate. When the sampling frequency is higher, the range of frequencies that can be played back are wider.
- Quantization bit
The number of quantization bits indicate the degree of accuracy when converting the sound level into a numeric value. When the number of quantized bits is higher, the expression of the sound level is more accurate.

WAV

Windows standard audio file format, which defines the method of recording the digital data obtained by converting audio signals. By default, the PCM method (no compression) is used, but you can also use other compression methods.

WMA (Windows Media Audio)

One of the compressed digital audio formats developed by Microsoft Corporation. With psychoacoustic technologies, this compression method achieves a high compression rate. Reportedly, it is capable of compressing data quantity by about 1/20 maintaining a certain level of audio quality.

Others

LFE (Low Frequency Effects) 0.1 channel

This channel reproduces low-frequency bass signals and has a frequency range from 20 Hz to 120 Hz. This channel is added to the channels for all bands with Dolby Digital or DTS to enhance low frequency audio effects. This channel is labeled 0.1 because it is limited to only low frequency audio.

Lip sync

Video output sometimes lags behind audio output due to the complexity of signal processing caused by an increase in video signal capacity. Lip sync is a technique for automatically correcting the timing lag between audio and video output.

HDMI and video information

Composite video signal

With the composite video signal system, color, brightness, and synchronization data signals are combined and transmitted with a single cable.

Deep Color

Deep Color is a technology that HDMI specification supports. Deep Color increases the number of available colors within the boundaries defined by the RGB or YCbCr color space. Conventional color systems process the color using 8 bits. Deep Color processes the color with 10, 12, or 16 bits. This technology allows HDTVs and other displays to increase from millions of colors to billions of colors and eliminate on-screen color banding for smooth tonal transitions and subtle gradations between colors.

HDMI

HDMI (High-Definition Multimedia Interface) is the world-wide standard interface for digital audio/video signal transmission. This interface transmits both digital audio and digital video signals using a single cable without any loss. HDMI complies with HDCP (High-bandwidth Digital Content Protection) and provides a secure audio/video interface. For further information on HDMI, visit the HDMI website at "<http://www.hdmi.org/>".

x.v.Color

"x.v.Color" is a technology that the HDMI specification supports. It is a more extensive color space than sRGB and allows the expression of colors that were not hitherto possible. While remaining compatible with the color gamut of sRGB standards, "x.v.Color" expands the color space, and thus can produce more vivid, natural images.

Yamaha technologies

CINEMA DSP (Digital Sound Field Processor)

Since the surround sound systems were originally designed for use in movie theaters, their effect is best experienced in a theater that has many speakers designed for acoustic effects. Since home conditions (such as room size, wall material, and number of speakers) can differ so widely, it is inevitable that there are differences in the sound that you hear. Based on a wealth of actually measured data, CINEMA DSP, Yamaha's original DSP technology provides the audiovisual experience of a movie theater in your own home.

Compressed Music Enhancer

The Compressed Music Enhancer feature compensates for missing harmonics in compression music formats (such as MP3). As a result, this technology provides improved performance for the overall sound system.

SILENT CINEMA

Yamaha has developed a natural, realistic sound effect DSP algorithm for headphones. Parameters for headphones have been set for each sound program, so that accurate representations of all the sound programs can be enjoyed on headphones.

Virtual CINEMA DSP

Virtual CINEMA DSP allows the system to virtually reproduce the sound field of the surround speakers with front left and right speakers. Even if the surround speakers are not connected, the unit creates the realistic sound field in a listening room.

YPAO (Yamaha Parametric room Acoustic Optimizer)

The Yamaha Parametric room Acoustic Optimizer (YPAO) function detects speaker connections, measures the distances from them to your listening position(s), and then automatically optimizes the speaker settings, such as volume balance and acoustic parameters, to suit your room.

Supported devices and file formats

The following devices and file formats can be used by the unit.

Supported devices

USB devices

- This unit supports USB mass storage class devices (e.g., flash memories or portable audio players) using FAT16 or FAT32 format.
- Do not connect devices other than USB mass storage class devices (such as USB chargers or USB hubs), PCs, card readers, an external HDD, etc.
- USB devices with encryption cannot be used.
- Operation of all USB devices cannot be guaranteed.

Bluetooth® devices

- Bluetooth devices that support A2DP can be used.
- Operation of all Bluetooth devices cannot be guaranteed.

File formats

USB

- The unit supports WAV (PCM format only), MP3, WMA and MPEG-4 AAC files (1- or 2-channel audio only).
- The unit is compatible with sampling rate of up to 48 kHz.
- Digital Rights Management (DRM) contents cannot be played back.

Video signal flow

Video signals input from a video device to the unit are output to a TV as shown below.

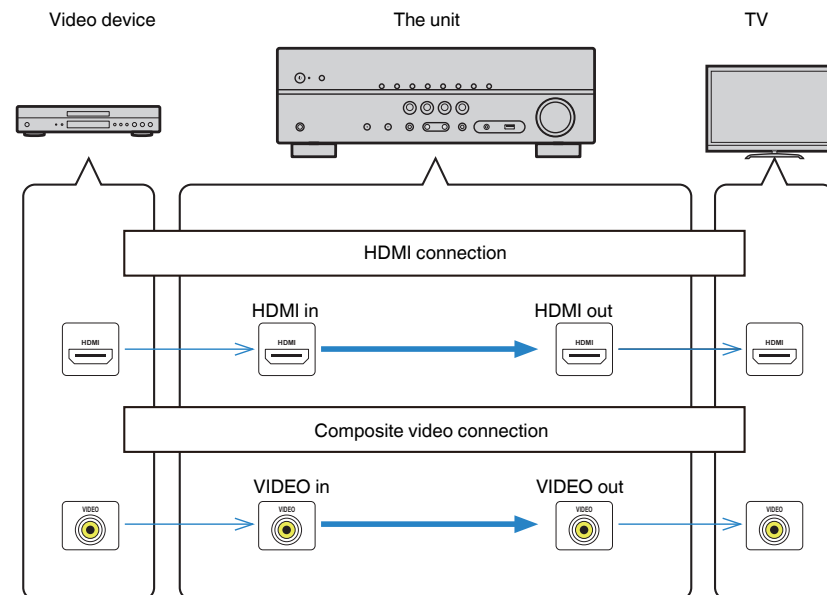

Information on HDMI

The additional information on HDMI is as follows.

HDMI Control

HDMI Control allows you to operate external devices via HDMI. If you connect a TV that supports HDMI Control to the unit with an HDMI cable, you can control the unit (such as power and volume) with TV remote control operations. You can also control playback devices (such as HDMI Control-compatible BD/DVD players) connected to the unit with an HDMI cable.

Operations available from the TV's remote control

- Standby synchronization
- Volume control including mute
- Switching to input audio from the TV when the TV input is switched to its built-in tuner
- Switching to input video/audio from the selected playback device
- Switching between audio output devices (the unit or TV speaker)

(Example)

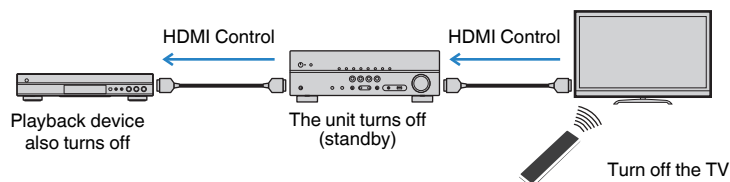

Operations available from the unit's remote control

- Starting playback on the playback device and turning on the TV with a scene selection (p.31)
- Switching the TV input to display the "Setup" menu (when SETUP is pressed)
- Controlling the playback device (playback and menu operations)

(Example)

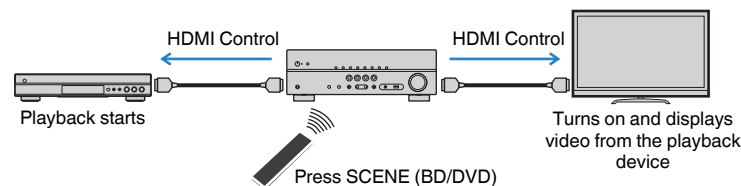

To use HDMI Control, you need to perform the following HDMI Control link setup after connecting the TV and playback devices.

For details on settings and operating your TV, refer to the instruction manual for the TV.

Note

This setup is required every time you add a new HDMI Control-compatible device to your system.

1 Turn on the unit, TV, and playback devices.

2 Configure the settings of the unit.

1 Switch the TV input to display video from the unit.

2 Press SETUP.

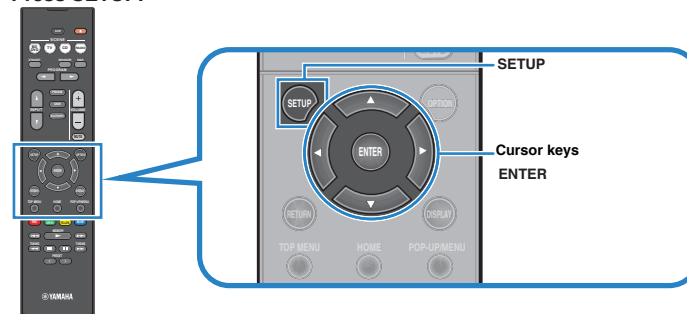

- 3** Use the cursor keys to select “HDMI” and press ENTER.

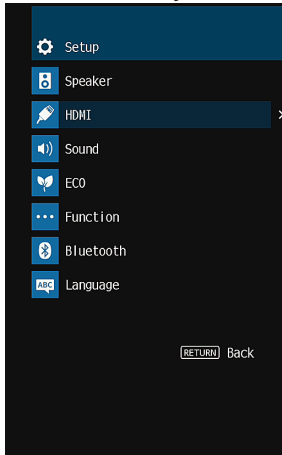

- 4** Use the cursor keys (Δ/∇) to select “HDMI Control” and the cursor keys (\langle/\rangle) to select “On” as shown below.

- 5** If you made a digital optical cable connection between the TV and the unit, use the cursor keys (Δ/∇) to select “TV Audio Input” and the cursor keys (\langle/\rangle) to select “AUDIO1”.

- 6** Press SETUP.

- 3** Enable HDMI Control on the TV and playback devices (such as HDMI Control-compatible BD/DVD players).
- 4** Turn off the main power of the TV and then turn off the unit and playback devices.
- 5** Turn on the unit and playback devices and then turn on the TV.
- 6** Switch the TV input to display the video from the unit.
- 7** Check the followings.

On the unit: The input to which the playback device is connected is selected. If not, select the input source manually.

On the TV: The video from the playback device is displayed.

- 8** Check that the unit is properly synchronized with the TV by turning off the TV or adjusting the TV volume with the TV remote control.

Note

- If HDMI Control does not work properly, the problem may be solved by turning the playback device off and on again, or by unplugging the power plug and plugging it in again. Also, HDMI Control may not work properly if the number of connected devices exceeds the limit. In this case, disable HDMI Control on devices not in use.
- If the unit is not synchronized to the TV's power operations, check the priority of the audio output setting on the TV.
- If you reconnect the HDMI cable, perform the procedure 5-8 again.
- We recommend using TV and playback devices from the same manufacturer so that HDMI Control works more effectively.

Audio Return Channel (ARC)

ARC allows you to input TV audio to the unit with the HDMI cable which transmits video signal to the TV.

Check the following after the HDMI Control settings.

- 1 Select a TV program with the TV remote control.**
- 2 Check that the input source of the unit will be automatically switched to “AV 2” and the TV audio will be played back on the unit.**

If you cannot hear the TV audio, check the following:

- “ARC” (p.58) in the “Setup” menu is set to “On”.
- The HDMI cable is connected to the ARC-compatible HDMI jack (HDMI jack marked “ARC”) on the TV.

Some HDMI jack on the TV is not compatible with ARC. For details, refer to the instruction manual for the TV.

Note

- If the audio is interrupted while using ARC, set “ARC” (p.58) in the “Setup” menu to “Off” and use a digital optical cable to input TV audio to the unit (p.19).
- When using ARC, connect a TV with an HDMI cable that supports ARC.
- “AV 2” is set as TV audio input at the factory. If you have connected any external device to the AV 2 jacks, use “TV Audio Input” (p.57) in the “Setup” menu to change the TV audio input assignment. To use the SCENE function (p.31), you also need to change the input assignment for SCENE (TV).

HDMI signal compatibility

- When CPPM copy-protected DVD-Audio is played back, video/audio signals may not be output, depending on the type of the DVD player.
- The unit is not compatible with HDCP-incompatible HDMI or DVI devices. For details, refer to the instruction manual for each device.
- To decode audio bitstream signals on the unit, set the input source device appropriately so that the device outputs the bitstream audio signals directly (does not decode the bitstream signals on the playback device). For details, refer to the instruction manual for the playback device.

Trademarks

The trademarks used in this manual are as follows.

DOLBY AUDIO

Manufactured under license from Dolby Laboratories. Dolby, Pro Logic, and the double-D symbol are trademarks of Dolby Laboratories.



For DTS patents, see <http://patents.dts.com>. Manufactured under license from DTS Licensing Limited. DTS, DTS-HD, the Symbol, & DTS and the Symbol together are registered trademarks of DTS, Inc. © DTS, Inc. All Rights Reserved.



The terms HDMI, the HDMI Logo, and High-Definition Multimedia Interface are trademarks or registered trademarks of HDMI Licensing LLC in the United States and other countries.

x.v.Color™

“x.v.Color” is a trademark of Sony Corporation.



The Bluetooth® word mark and logos are registered trademarks owned by Bluetooth SIG, Inc. and any use of such marks by Yamaha Corporation is under license.

App Store is a service mark of Apple Inc.

Android™ is a trademark of Google Inc.

SILENT™ CINEMA

“SILENT CINEMA” is a trademark of Yamaha Corporation.

Google Noto Fonts

This product uses the following fonts.

Copyright © June 2015, Google
(<https://www.google.com/get/noto/#sans-lgc>), with Reserved Font Name Noto Sans Version 1.004.

Copyright © June 2015, Google
(<https://www.google.com/get/noto/help/cjk/>), with Reserved Font Name Noto Sans CJK Version 1.004.

This Font Software is licensed under the SIL Open Font License, Version 1.1.

This license is available with a FAQ at:
<http://scripts.sil.org/OFL>

Specifications

The specifications of this unit are as follows.

Input jacks

Analog Audio

- Audio x 3

Digital Audio (Supported frequencies: 32 kHz to 96 kHz)

- Optical x 1
- Coaxial x 2

Video

- Composite x 3

HDMI Input

- HDMI x 4

Other jacks

- USB x 1 (USB2.0)

Output jacks

Analog Audio

- Speaker Out x 5 (FRONT L/R, CENTER, SURROUND L/R)
- Subwoofer Out x 1
- Headphone x 1

Video

- Composite x 1

HDMI Output

- HDMI OUT x 1

Other jacks

YPAO MIC x 1

HDMI

HDMI Features:

- 4K UltraHD Video (include 4K/60, 50Hz 10/12bit), 3D Video, ARC (Audio Return Channel), HDMI Control (CEC), Auto Lip Sync, Deep Color, "x.v.Color", HD audio playback, 21:9 Aspect Ratio, BT.2020 Colorimetry, HDR Compatible

Video Format (Repeater Mode)

- VGA
- 480i/60 Hz
- 576i/50 Hz
- 480p/60 Hz
- 576p/50 Hz
- 720p/60 Hz, 50 Hz
- 1080i/60 Hz, 50 Hz
- 1080p/60 Hz, 50 Hz, 30 Hz, 25 Hz, 24 Hz
- 4K/60Hz, 50Hz, 30 Hz, 25 Hz, 24 Hz

Audio Format

- Dolby TrueHD
- Dolby Digital Plus
- Dolby Digital
- DTS-HD Master Audio
- DTS-HD High Resolution Audio
- DTS Express
- DTS
- DSD 2-ch to 6-ch
- PCM 2-ch to 8-ch (Max. 192 kHz/24-bit)

Content Protection: HDCP 2.2 compatible

Link Function: CEC supported

TUNER

Analog Tuner

- [U.K. and Europe models]
FM/AM with Radio Data System x 1 (TUNER)
- [Other models]
FM/AM x 1 (TUNER)

USB

Capable of Mass Storage Class USB Memory

Current Supply Capacity: 0.5 A

Bluetooth

Bluetooth version

- Ver. 2.1+EDR

Supported profile

- A2DP

Supported codec

- SBC

Wireless output

- Bluetooth Class 2

Radio Frequency (Operational Frequency)

- 2402 MHz to 2480 MHz

Maximum Output Power (E.I.R.P)

- 4 dBm (2.51 mW)

Maximum communication distance

- 10 m (33 ft) without interference

Compatible Decoding Formats

Decoding Format

- Dolby TrueHD, Dolby Digital Plus
- Dolby Digital
- DTS-HD Master Audio, DTS-HD High Resolution Audio, DTS Express
- DTS, DTS 96/24

Post Decoding Format

- Dolby Pro Logic
- Dolby Pro Logic II Music, Dolby Pro Logic II Movie, Dolby Pro Logic II Game
- DTS Neo: 6 Music, DTS Neo: 6 Cinema

Audio Section

Rated Output Power (2-channel driven)

- [U.S.A. and Canada models] (20 Hz to 20 kHz, 0.09% THD, 8 Ω)
- [Other models] (20 Hz to 20 kHz, 0.09% THD, 6 Ω)
 - Front L/R 70 W+70 W
- [U.S.A. and Canada models] (1 kHz, 0.9% THD, 8 Ω)
 - Front L/R 85 W+85 W
 - Center 85 W
 - Surround L/R 85 W+85 W

Rated Output Power (1-channel driven)

- [U.S.A. and Canada models] (1 kHz, 0.9% THD, 8 Ω)
- [Other models] (1 kHz, 0.9% THD, 6 Ω)
 - Front L/R 100 W/ch
 - Center 100 W/ch
 - Surround L/R 100 W/ch

Maximum Effective Output Power (1-channel driven)

- [U.S.A. and Canada models] (1 kHz, 10% THD, 8 Ω)
 - Front L/R, Center, Surround L/R 130 W/ch
- [Other models] (1 kHz, 10% THD, 6 Ω)
 - Front L/R, Center, Surround L/R 145 W/ch
- [Other models] (1 kHz, 10% THD, 6 Ω)
 - Front L/R, Center, Surround L/R 135 W/ch

Dynamic Power (IHF)

- [U.S.A. and Canada models]
 - Front L/R (8/6/4/2 Ω) 110/130/160/180 W
- [Other models]
 - Front L/R (6/4/2 Ω) 110/130/150 W

Damping Factor

- Front L/R, 20 Hz to 20 kHz, 8 Ω 100 or more

Input Sensitivity / Input Impedance

- AV 2 etc. (1 kHz, 100 W/6 Ω) 200 mV/47 k Ω

Maximum Input Signal

- AV 2 etc. (1 kHz, 0.5% THD, Effect On) 2.3 V

Output Level / Output Impedance	
• SUBWOOFER	1 V/1.2 k Ω
Headphone Jack Rated Output / Impedance	
• AV 2 etc. (1 kHz, 50 mV, 8 Ω)	100 mV/470 Ω
Frequency Response	
• AV 2 etc. to Front (10 Hz to 100 kHz)	+0/-3 dB
Signal to Noise Ratio (IHF-A Network)	
• AV 2 etc. (Input 1 k Ω Shorted, Speaker Out)	110 dB or more
Residual Noise (IHF-A Network)	
• Front L/R (Speaker Out)	150 μ V or less
Channel Separation	
• AV 2 etc. (Input 1 k Ω Shorted, 1 kHz/10 kHz)	70 dB/50 dB or more
Volume Control	
• Range	MUTE, -80 dB to +16.5 dB
• Step	0.5 dB
Tone Control Characteristics	
• Bass Boost/Cut	\pm 6 dB/0.5 dB Step at 50 Hz
• Bass Turnover	350 Hz
• Treble Boost/Cut	\pm 6 dB/0.5 dB Step at 20 kHz
• Treble Turnover	3.5 kHz
Filter Characteristics	
(f_c =40/60/80/90/100/110/120/160/200 Hz)	
• H.P.F. (Front, Center, Surround)	12 dB/oct.
• L.P.F. (Subwoofer)	24 dB/oct.

Video Section

Video Signal Type	
• [U.S.A., Canada, Korea, Taiwan, Brazil and General models]	NTSC
• [Other models]	PAL
Video Signal Level	
• Composite	1 Vp-p/75 Ω

Video Maximum Input Level	1.5 Vp-p or more
Video Signal to Noise Ratio	50 dB or more

FM Section

Tuning Range	
• [U.S.A. and Canada models]	87.5 MHz to 107.9 MHz
• [Asia, Taiwan, Brazil and General models]	87.5/87.50 MHz to 108.0/108.00 MHz
• [U.K. and Europe models]	87.50 MHz to 108.00 MHz
• [Other models]	87.50 MHz to 108.00 MHz
50 dB Quiet Sensitivity (IHF, 1 kHz, 100% MOD.)	
• Mono	3 μ V (20.8 dBf)
Signal to Noise Ratio (IHF)	
• Mono	65 dB
• Stereo	64 dB
Harmonic Distortion (IHF, 1 kHz)	
• Mono	0.5%
• Stereo	0.6%
Antenna Input	75 Ω unbalanced

AM section

Tuning Range	
• [U.S.A. and Canada models]	530 kHz to 1710 kHz
• [Asia, Taiwan, Brazil and General models]	530/531 kHz to 1710/1611 kHz
• [U.K. and Europe models]	531 kHz to 1611 kHz
• [Other models]	531 kHz to 1611 kHz

General

Power Supply

- [U.S.A. and Canada models] AC 120 V, 60 Hz
 - [Taiwan, Brazil and General models] AC 110 to 120/220 to 240 V, 50/60 Hz
 - [Korea model] AC 220 V, 60 Hz
 - [Australia model] AC 240 V, 50 Hz
 - [U.K. and Europe models] AC 230 V, 50 Hz
 - [Asia model] AC 220 to 240 V, 50/60 Hz
-

Power Consumption

260 W

Standby Power Consumption

- HDMI Control Off
 - [Taiwan, Brazil and General models] 0.5 W
 - [Other models] 0.3 W
 - HDMI Control On (No Signals) 0.9 W
 - Bluetooth Standby ON 0.6 W
 - HDMI Control On, Bluetooth Standby ON 1.2 W
-

Maximum Power Consumption

- [Taiwan, Brazil and General models] 470 W
-

Dimensions (W x H x D)

435 x 151 x 315 mm (17-1/8" x 6" x 12-3/8")

Weight

7.4 kg (16.3 lbs)

* The contents of this manual apply to the latest specifications as of the publishing date. To obtain the latest manual, access the Yamaha website then download the manual file.

Yamaha Global Site
<http://www.yamaha.com/>

Yamaha Downloads
<http://download.yamaha.com/>

Manual Development Group
© 2017 Yamaha Corporation

Published 02/2017 NV-A0

YJ186A0/EN1