



# *RX-V2600*

---

*AV Receiver*

OWNER'S MANUAL

# IMPORTANT SAFETY INSTRUCTIONS

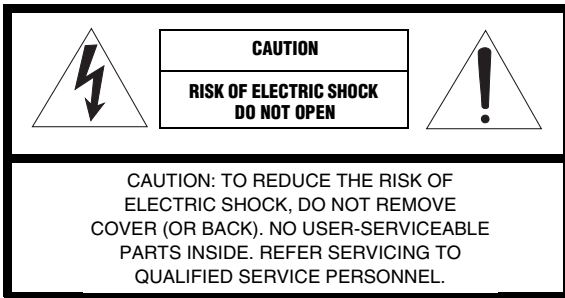

## • Explanation of Graphical Symbols



The lightning flash with arrowhead symbol, within an equilateral triangle, is intended to alert you to the presence of uninsulated “dangerous voltage” within the product’s enclosure that may be of sufficient magnitude to constitute a risk of electric shock to persons.



The exclamation point within an equilateral triangle is intended to alert you to the presence of important operating and maintenance (servicing) instructions in the literature accompanying the appliance.

- 1 Read Instructions – All the safety and operating instructions should be read before the product is operated.
- 2 Retain Instructions – The safety and operating instructions should be retained for future reference.
- 3 Heed Warnings – All warnings on the product and in the operating instructions should be adhered to.
- 4 Follow Instructions – All operating and use instructions should be followed.
- 5 Cleaning – Unplug this product from the wall outlet before cleaning. Do not use liquid cleaners or aerosol cleaners.
- 6 Attachments – Do not use attachments not recommended by the product manufacturer as they may cause hazards.
- 7 Water and Moisture – Do not use this product near water – for example, near a bath tub, wash bowl, kitchen sink, or laundry tub; in a wet basement; or near a swimming pool; and the like.
- 8 Accessories – Do not place this product on an unstable cart, stand, tripod, bracket, or table. The product may fall, causing serious injury to a child or adult, and serious damage to the product. Use only with a cart, stand, tripod, bracket, or table recommended by the manufacturer, or sold with the product. Any mounting of the product should follow the manufacturer’s instructions, and should use a mounting accessory recommended by the manufacturer.
- 9 A product and cart combination should be moved with care. Quick stops, excessive force, and uneven surfaces may cause the product and cart combination to overturn.



- 10 Ventilation – Slots and openings in the cabinet are provided for ventilation and to ensure reliable operation of the product and to protect it from overheating, and these openings must not be blocked or covered. The openings should never be blocked by placing the product on a bed, sofa, rug, or other similar surface. This product should not be placed in a built-in installation such as a bookcase or rack unless proper ventilation is provided or the manufacturer’s instructions have been adhered to.
- 11 Power Sources – This product should be operated only from the type of power source indicated on the marking label. If you are not sure of the type of power supply to your home, consult your product dealer or local power company. For products intended to operate from battery power, or other sources, refer to the operating instructions.
- 12 Grounding or Polarization – This product may be equipped with a polarized alternating current line plug (a plug having one blade wider than the other). This plug will fit into the power outlet only one way. This is a safety feature. If you are unable to insert the plug fully into the outlet, try reversing the plug. If the plug should still fail to fit, contact your electrician to replace your obsolete outlet. Do not defeat the safety purpose of the polarized plug.
- 13 Power-Cord Protection – Power-supply cords should be routed so that they are not likely to be walked on or pinched by items placed upon or against them, paying particular attention to cords at plugs, convenience receptacles, and the point where they exit from the product.
- 14 Lightning – For added protection for this product during a lightning storm, or when it is left unattended and unused for long periods of time, unplug it from the wall outlet and disconnect the antenna or cable system. This will prevent damage to the product due to lightning and power-line surges.
- 15 Power Lines – An outside antenna system should not be located in the vicinity of overhead power lines or other electric light or power circuits, or where it can fall into such power lines or circuits. When installing an outside antenna system, extreme care should be taken to keep from touching such power lines or circuits as contact with them might be fatal.
- 16 Overloading – Do not overload wall outlets, extension cords, or integral convenience receptacles as this can result in a risk of fire or electric shock.
- 17 Object and Liquid Entry – Never push objects of any kind into this product through openings as they may touch dangerous voltage points or short-out parts that could result in a fire or electric shock. Never spill liquid of any kind on the product.
- 18 Servicing – Do not attempt to service this product yourself as opening or removing covers may expose you to dangerous voltage or other hazards. Refer all servicing to qualified service personnel.
- 19 Damage Requiring Service – Unplug this product from the wall outlet and refer servicing to qualified service personnel under the following conditions:
  - a) When the power-supply cord or plug is damaged,
  - b) If liquid has been spilled, or objects have fallen into the product,
  - c) If the product has been exposed to rain or water,

- d) If the product does not operate normally by following the operating instructions. Adjust only those controls that are covered by the operating instructions as an improper adjustment of other controls may result in damage and will often require extensive work by a qualified technician to restore the product to its normal operation,
  - e) If the product has been dropped or damaged in any way, and
  - f) When the product exhibits a distinct change in performance - this indicates a need for service.
- 20 Replacement Parts** – When replacement parts are required, be sure the service technician has used replacement parts specified by the manufacturer or have the same characteristics as the original part. Unauthorized substitutions may result in fire, electric shock, or other hazards.
- 21 Safety Check** – Upon completion of any service or repairs to this product, ask the service technician to perform safety checks to determine that the product is in proper operating condition.
- 22 Wall or Ceiling Mounting** – The unit should be mounted to a wall or ceiling only as recommended by the manufacturer.
- 23 Heat** – The product should be situated away from heat sources such as radiators, heat registers, stoves, or other products (including amplifiers) that produce heat.

- 24 Outdoor Antenna Grounding** – If an outside antenna or cable system is connected to the product, be sure the antenna or cable system is grounded so as to provide some protection against voltage surges and built-up static charges. Article 810 of the National Electrical Code, ANSI/NFPA 70, provides information with regard to proper grounding of the mast and supporting structure, grounding of the lead-in wire to an antenna discharge unit, size of grounding conductors, location of antenna discharge unit, connection to grounding electrodes, and requirements for the grounding electrode.

EXAMPLE OF ANTENNA GROUNDING



NEC – NATIONAL ELECTRICAL CODE

**Note to CATV system installer:**

This reminder is provided to call the CATV system installer’s attention to Article 820-40 of the NEC that provides guidelines for proper grounding and, in particular, specifies that the cable ground shall be connected to the grounding system of the building, as close to the point of cable entry as practical.

**FCC INFORMATION (for US customers)**

**1 IMPORTANT NOTICE: DO NOT MODIFY THIS UNIT!**

This product, when installed as indicated in the instructions contained in this manual, meets FCC requirements. Modifications not expressly approved by Yamaha may void your authority, granted by the FCC, to use the product.

- 2 IMPORTANT:** When connecting this product to accessories and/or another product use only high quality shielded cables. Cable/s supplied with this product **MUST** be used. Follow all installation instructions. Failure to follow instructions could void your FCC authorization to use this product in the USA.

- 3 NOTE:** This product has been tested and found to comply with the requirements listed in FCC Regulations, Part 15 for Class “B” digital devices. Compliance with these requirements provides a reasonable level of assurance that your use of this product in a residential environment will not result in harmful interference with other electronic devices.

This equipment generates/uses radio frequencies and, if not installed and used according to the instructions found in the users manual, may cause interference harmful to the operation of other electronic devices.

Compliance with FCC regulations does not guarantee that interference will not occur in all installations. If this product is found to be the source of interference, which can be determined by turning the unit “OFF” and “ON”, please try to eliminate the problem by using one of the following measures:

Relocate either this product or the device that is being affected by the interference.

Utilize power outlets that are on different branch (circuit breaker or fuse) circuits or install AC line filter/s.

In the case of radio or TV interference, relocate/reorient the antenna. If the antenna lead-in is 300 ohm ribbon lead, change the lead-in to coaxial type cable.

If these corrective measures do not produce satisfactory results, please contact the local retailer authorized to distribute this type of product. If you can not locate the appropriate retailer, please contact Yamaha Electronics Corp., U.S.A. 6660 Orangethorpe Ave, Buena Park, CA 90620.

The above statements apply **ONLY** to those products distributed by Yamaha Corporation of America or its subsidiaries.

# CAUTION: READ THIS BEFORE OPERATING YOUR UNIT.

- 1 To assure the finest performance, please read this manual carefully. Keep it in a safe place for future reference.
- 2 Install this sound system in a well ventilated, cool, dry, clean place – away from direct sunlight, heat sources, vibration, dust, moisture, and/or cold. Allow ventilation space of at least 30 cm on the top, 20 cm on the left and right, and 20 cm on the back of this unit.
- 3 Locate this unit away from other electrical appliances, motors, or transformers to avoid humming sounds.
- 4 Do not expose this unit to sudden temperature changes from cold to hot, and do not locate this unit in an environment with high humidity (i.e. a room with a humidifier) to prevent condensation inside this unit, which may cause an electrical shock, fire, damage to this unit, and/or personal injury.
- 5 Avoid installing this unit where foreign objects may fall onto this unit and/or this unit may be exposed to liquid dripping or splashing. On the top of this unit, do not place:
  - Other components, as they may cause damage and/or discoloration on the surface of this unit.
  - Burning objects (i.e. candles), as they may cause fire, damage to this unit, and/or personal injury.
  - Containers with liquid in them, as they may fall and liquid may cause electrical shock to the user and/or damage to this unit.
- 6 Do not cover this unit with a newspaper, tablecloth, curtain, etc. in order not to obstruct heat radiation. If the temperature inside this unit rises, it may cause fire, damage to this unit, and/or personal injury.
- 7 Do not plug in this unit to a wall outlet until all connections are complete.
- 8 Do not operate this unit upside-down. It may overheat, possibly causing damage.
- 9 Do not use force on switches, knobs and/or cords.
- 10 When disconnecting the power cable from the wall outlet, grasp the plug; do not pull the cable.
- 11 Do not clean this unit with chemical solvents; this might damage the finish. Use a clean, dry cloth.
- 12 Only voltage specified on this unit must be used. Using this unit with a higher voltage than specified is dangerous and may cause fire, damage to this unit, and/or personal injury. YAMAHA will not be held responsible for any damage resulting from use of this unit with a voltage other than specified.
- 13 To prevent damage by lightning, keep the power cord and outdoor antennas disconnected from a wall outlet or the unit during a lightning storm.
- 14 Do not attempt to modify or fix this unit. Contact qualified YAMAHA service personnel when any service is needed. The cabinet should never be opened for any reasons.
- 15 When not planning to use this unit for long periods of time (i.e. vacation), disconnect the AC power plug from the wall outlet.
- 16 Install this unit near the AC outlet and where the AC power plug can be reached easily.
- 17 Be sure to read the “TROUBLESHOOTING” section on common operating errors before concluding that this unit is faulty.
- 18 Before moving this unit, press MASTER ON/OFF to release it outward to the OFF position to turn off this unit, the main room, Zone 2 and Zone 3 and then disconnect the AC power plug from the AC wall outlet.

## WARNING

TO REDUCE THE RISK OF FIRE OR ELECTRIC SHOCK, DO NOT EXPOSE THIS UNIT TO RAIN OR MOISTURE.

As long as this unit is connected to the AC wall outlet, it is not disconnected from the AC power source even if you turn off this unit by MASTER ON/OFF. In this state, this unit is designed to consume a very small quantity of power.

## FOR CANADIAN CUSTOMERS

To prevent electric shock, match wide blade of plug to wide slot and fully insert.

This Class B digital apparatus complies with Canadian ICES-003.

## POUR LES CONSOMMATEURS CANADIENS

Pour éviter les chocs électriques, introduire la lame la plus large de la fiche dans la borne correspondante de la prise et pousser jusqu'au fond.

Cet appareil numérique de la classe B est conforme à la norme NMB-003 du Canada.

## IMPORTANT

Please record the serial number of this unit in the space below.

MODEL:

Serial No.:

The serial number is located on the rear of the unit.

Retain this Owner's Manual in a safe place for future reference.

## We Want You Listening For A Lifetime

YAMAHA and the Electronic Industries Association's Consumer Electronics Group want you to get the most out of your equipment by playing it at a safe level. One that lets the sound come through loud and clear without annoying blaring or distortion – and, most importantly, without affecting your sensitive hearing. Since hearing damage from loud sounds is often undetectable until it is too late, YAMAHA and the Electronic Industries Association's Consumer Electronics Group recommend you to avoid prolonged exposure from excessive volume levels.



# CONTENTS

## INTRODUCTION

<b>FEATURES</b> .....	<b>2</b>
<b>GETTING STARTED</b> .....	<b>3</b>
Supplied accessories .....	3
Installing batteries in the remote controls.....	4
Handling the remote control .....	5
Opening and closing the front panel door.....	5
<b>CONTROLS AND FUNCTIONS</b> .....	<b>6</b>
Front panel .....	6
Remote control.....	8
Zone 2/Zone 3 remote control .....	10
Front panel display .....	11
Rear panel .....	13

## PREPARATION

<b>CONNECTIONS</b> .....	<b>14</b>
Before connecting speakers .....	14
Connecting speakers .....	15
Using bi-wire and bi-AMP connections .....	19
Information on cables and jacks used for connections .....	20
Connecting HDMI components .....	23
Connecting video components.....	24
Connecting audio components.....	27
Connecting the antennas .....	29
Connecting the power cable.....	30
Turning on and off this unit .....	30
Setting the speaker impedance.....	31
<b>AUTO SETUP</b> .....	<b>32</b>
Introduction.....	32
Optimizer microphone setup.....	32
Using AUTO SETUP .....	33
Confirming the results .....	35

## BASIC OPERATION

<b>PLAYBACK</b> .....	<b>37</b>
Basic operations.....	37
Additional operations.....	39
<b>RECORDING</b> .....	<b>46</b>
<b>FM/AM TUNING</b> .....	<b>47</b>
Automatic tuning .....	47
Manual tuning .....	48
Automatic preset tuning.....	48
Manual preset tuning .....	50
Selecting preset stations.....	51
Exchanging preset stations .....	52
<b>XM@ SATELLITE RADIO TUNING</b> .....	<b>53</b>
What is XM Satellite Radio?.....	53
XM Satellite Radio connections .....	53
XM Satellite Radio controls and functions.....	54
Activating XM Satellite Radio .....	55
Selecting the XM Satellite Radio mode.....	56
Using XM Satellite Radio search modes .....	57
Setting XM Satellite Radio preset channels .....	60
Displaying the XM Satellite Radio information .....	62

## SOUND FIELD PROGRAMS

<b>EDITING SOUND FIELD PARAMETERS</b> .....	<b>63</b>
What is a sound field? .....	63
Changing parameter settings .....	63
<b>SOUND FIELD PROGRAM DESCRIPTIONS</b> .....	<b>65</b>
For movie/video sources.....	65
For music sources .....	67
<b>SOUND FIELD PARAMETER DESCRIPTIONS</b> .....	<b>68</b>
<b>SOUND FIELD PROGRAM SPEAKER LAYOUTS</b> .....	<b>73</b>

## ADVANCED OPERATION

<b>SYSTEM OPTIONS</b> .....	<b>77</b>
Changing parameter settings .....	79
Input Select .....	80
Manual Setup (Sound) .....	83
Manual Setup (Video) .....	87
Manual Setup (Basic) .....	90
Manual Setup (Option) .....	94
System Memory.....	99
Language .....	100
<b>ADVANCED SETUP</b> .....	<b>101</b>
Using ADVANCED SETUP .....	101
<b>REMOTE CONTROL FEATURES</b> .....	<b>103</b>
Control area .....	103
Controlling each component.....	104
Setting remote control codes .....	105
Using LEARN .....	107
Using RE-NAME .....	109
Using MACRO .....	110
Using CLEAR.....	112
<b>ZONE 2/ZONE 3</b> .....	<b>115</b>
Connecting the Zone 2 and Zone 3 components .....	115
Selecting Zone 2 or Zone 3.....	116
Controlling Zone 2 and Zone 3.....	117
Using the control mode of Zone 2 and Zone 3 .....	118
<b>HDMI</b> .....	<b>119</b>
What is HDMI? .....	119
Setting the HDMI parameters.....	120
Basic HDMI operations .....	120

## ADDITIONAL INFORMATION

<b>TROUBLESHOOTING</b> .....	<b>121</b>
<b>GLOSSARY</b> .....	<b>128</b>
Audio information .....	128
Video information.....	131
Sound field program information .....	131
Parametric equalizer information .....	132
<b>SPECIFICATIONS</b> .....	<b>133</b>

# FEATURES

## Built-in 7-channel power amplifier

- ◆ Minimum RMS Output Power (0.04% THD, 20 Hz to 20 kHz, 8 Ω)  
Front: 130 W + 130 W  
Center: 130 W  
Surround: 130 W + 130 W  
Surround Back: 130 W + 130 W

## Sound field features

- ◆ Proprietary YAMAHA technology for the creation of sound fields
- ◆ THX Select2
- ◆ Dolby Digital/Dolby Digital EX decoder
- ◆ DTS/DTS-ES Matrix 6.1, Discrete 6.1, DTS Neo:6 decoder, DTS 96/24
- ◆ Dolby Pro Logic/Dolby Pro Logic IIx decoder
- ◆ Virtual CINEMA DSP
- ◆ SILENT CINEMA™

## HDMI (High-Definition Multimedia Interface)

- ◆ HDMI interface for standard, enhanced or high-definition video as well as multi-channel digital audio
- ◆ Analog video to HDMI digital video up-conversion (composite video ↔ S-video ↔ component video → HDMI digital video) and up-scaling (480i → 480p/1080i/720p and 480p → 1080i/720p) capabilities for monitor out

## Sophisticated AM/FM tuner

- ◆ 40-station random access preset tuning
- ◆ Automatic preset tuning
- ◆ Preset station shifting capability (preset editing)

-  indicates a tip for your operation.
- Some operations can be performed by using either the buttons on the main unit or on the remote control. In cases when the button names differ between the main unit and the remote control, the button name on the remote control is given in parentheses.
- This manual is printed prior to production. Design and specifications are subject to change in part as a result of improvements, etc. In case of differences between the manual and product, the product has priority.



Manufactured under license from Dolby Laboratories. “Dolby”, “Surround EX”, and the double-D symbol are trademarks of Dolby Laboratories.



“DTS”, “DTS-ES”, “Neo:6” and “DTS 96/24” are trademarks of Digital Theater Systems, Inc.



“HDMI”, the “HDMI” logo and “High-Definition Multimedia Interface” are trademarks or registered trademarks of HDMI Licensing LLC.

## XM Satellite Radio (U.S.A. model only)

- ◆ XM Satellite Radio tuning capability

## Other features

- ◆ YPAO (YAMAHA Parametric Room Acoustic Optimizer) for automatic speaker setup
- ◆ 192-kHz/24-bit D/A converter
- ◆ GUI (graphical user interface) menus that allow you to optimize this unit to suit your individual audio/video system
- ◆ GUI display menu language switching capability (English, Japanese, French, German and Spanish)
- ◆ 6 or 8-channel additional input jacks for discrete multi-channel input
- ◆ Short message function
- ◆ PURE DIRECT for pure fidelity sound with analog and PCM sources
- ◆ S-video input/output capability
- ◆ Component video input/output capability
- ◆ Analog video I/P conversion from 480i to 480p
- ◆ Optical and coaxial digital audio signal jacks
- ◆ Sleep timer
- ◆ Cinema and music night listening mode
- ◆ Remote control with preset remote control codes and learning/macro capability
- ◆ Zone 2/Zone 3 custom installation facility
- ◆ Zone 2/Zone 3 remote control to control Zone 2 or Zone 3
- ◆ Zone 2 OSD (on-screen display) capability

SILENT™  
CINEMA

“SILENT CINEMA” is a trademark of YAMAHA CORPORATION.



THX and Select2 are trademarks of THX Ltd. THX may be registered in some jurisdictions. Surround EX is a trademark of Dolby Laboratories. Used with permission.



© 2005 XM Satellite Radio Inc. All rights reserved. All other trademarks are the property of their respective owners.

# GETTING STARTED

## Supplied accessories

Please check that you received all of the following parts.

### Remote control

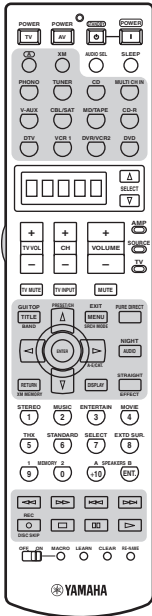

### Zone 2/Zone 3 remote control

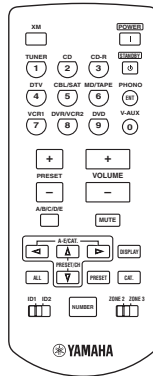

### Batteries (x6) (AAA, LR03)

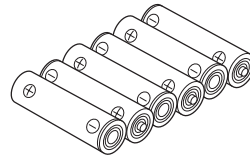

### Power cable

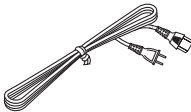

### Speaker terminal wrench

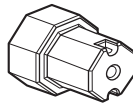

### Optimizer microphone

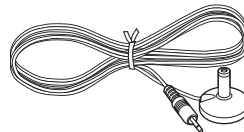

### AM loop antenna

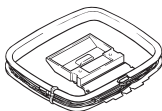

### Indoor FM antenna

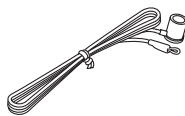

## Installing batteries in the remote controls

### Notes

- Change all of the batteries if you notice conditions such as the operation range of the remote control decreases, the indicator does not flash, or its light or display window become dim.
- Do not use old batteries together with new ones.
- Do not use different types of batteries (such as alkaline and manganese batteries) together. Read the packaging carefully as these different types of batteries may have the same shape and color.
- We strongly recommend using alkaline batteries.
- If the batteries have leaked, dispose of them immediately. Avoid touching the leaked material or letting it come into contact with clothing, etc. Clean the battery compartment thoroughly before installing new batteries.
- Do not throw away batteries with general house waste; dispose of them correctly in accordance with your local regulations.

### ■ Installing batteries

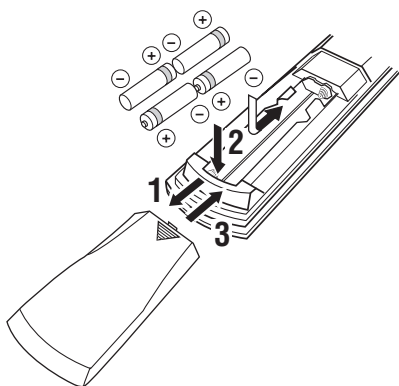

**1** Press the ▼ part and slide the battery compartment cover off.

**2** Insert four supplied batteries (AAA, LR03) according to the polarity markings on the inside of the battery compartment.

**3** Slide the cover back until it snaps into place.

If the remote control is without batteries for more than 2 minutes, or if exhausted batteries remain in the remote control, the contents of the memory may be cleared. When the memory is cleared, insert new batteries, set up the remote control code and program any acquired functions that may have been cleared.

### ■ Zone 2/Zone 3 remote control

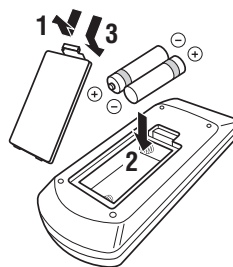

**1** Press the ▼ part and slide the battery compartment cover off.

**2** Insert two supplied batteries (AAA, LR03) according to the polarity markings (+ and -) on the inside of the battery compartment.

**3** Slide the cover back until it snaps into place.



## Handling the remote control

The remote control transmits a directional infrared ray.

Be sure to aim the remote control directly at the remote control sensor on the main unit during operation.

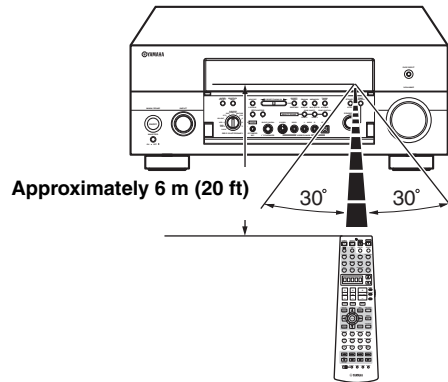

### Notes

- Do not spill water or other liquids on the remote control.
- Do not drop the remote control.
- Do not leave or store the remote control in the following types of conditions:
  - places of high humidity, such as near a bath
  - places of high temperatures, such as near a heater or stove
  - extremely low temperatures
  - dusty places

## Opening and closing the front panel door

When you want to use the controls behind the front panel door, open the door by gently pressing on the lower part of the panel. Keep the door closed when not using these controls.

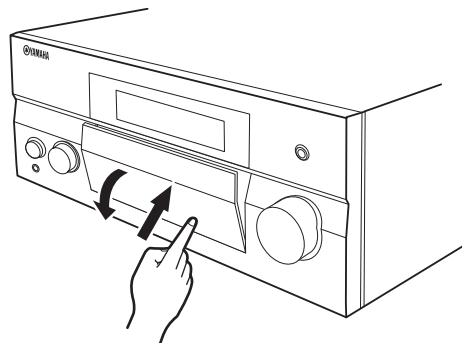

To open, press gently on the lower part of the panel.

# CONTROLS AND FUNCTIONS

## Front panel

### Note

The XM Satellite Radio controls (SEARCH MODE, CATEGORY, PRESET/TUNING/CH ◀/▶, MEMORY and DISPLAY) are only applicable to the U.S.A. model and are operational only when XM is selected as the input source. For details, see “Front panel functions” on page 54.

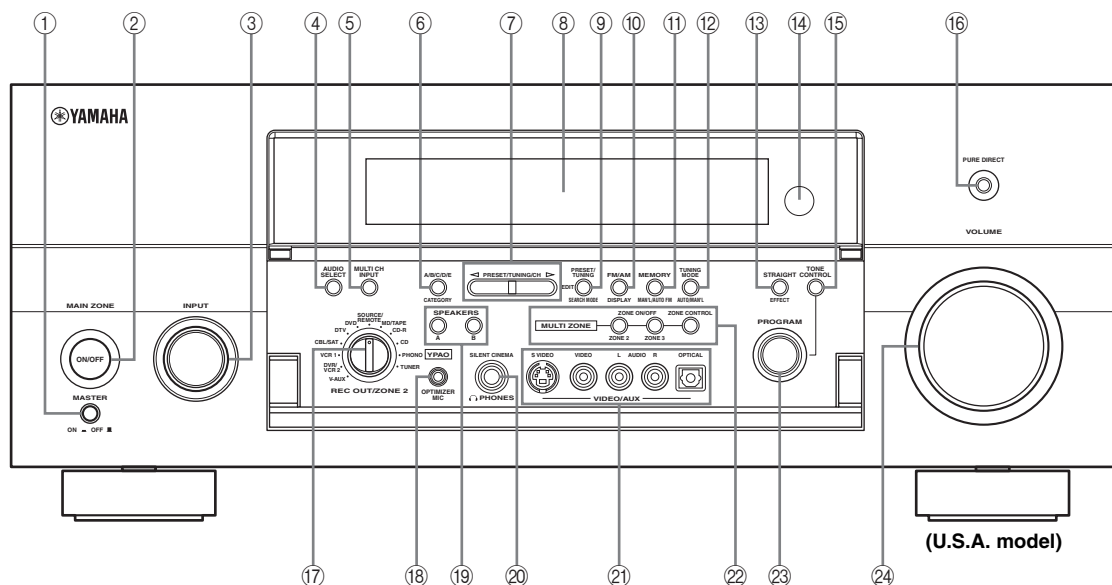

### ① MASTER ON/OFF

Press inward to the ON position.

- Turns on this unit.
- Turns on the main room.
- Sets Zone 2 and Zone 3 to the standby mode.

Press again to release it outward to the OFF position.

- Turns off this unit.
- Turns off the main room, Zone 2 and Zone 3.

See page 30 for details.

### ② MAIN ZONE ON/OFF

Turns on this unit only or sets it to the standby mode.



In the standby mode, this unit consumes a small quantity of power.

### Notes

- When you turn on this unit, there will be a 6 to 7 second delay before this unit can reproduce sound.
- This button is operational only when MASTER ON/OFF is pressed inward to the ON position.

### ③ INPUT selector

Selects the desired input source.

### ④ AUDIO SELECT

Toggles the priority for the type of audio input jack between AUTO, HDMI, COAX/OPT and ANALOG when one component is connected to two or more input jacks on the rear panel (see page 44).

### ⑤ MULTI CH INPUT

Selects the input source connected to the MULTI CH INPUT jacks. When selected, the MULTI CH INPUT source takes priority over the input source selected with the INPUT selector (or the input selector buttons on the remote control).

### ⑥ A/B/C/D/E

Selects one of the 5 preset station groups (A to E) when TUNER is selected as the input source (see page 51).

### ⑦ PRESET/TUNING/CH ◀/▶

Selects the preset station number (1 to 8) when TUNER is selected as the input source and the colon (:) is displayed next to the band indication in the front panel display. Selects the tuning frequency when TUNER is selected as the input source and the colon (:) is not displayed in the front panel display.

See pages 47 to 52 for details.

**⑧ Front panel display**

Shows information about the operational status of this unit.

**⑨ PRESET/TUNING (EDIT)**

Switches the function of PRESET/TUNING/CH ◀/▶ between selecting preset station numbers and tuning when TUNER is selected as the input source (see pages 47 to 52).

**⑩ FM/AM**

Switches the reception band (FM or AM) when TUNER is selected as the input source (see page 47).

**Note**

The frequency of the previously received station is automatically recalled.

**⑪ MEMORY (MAN'L/AUTO FM)**

Stores a station in the memory when TUNER is selected as the input source. Hold down for more than 3 seconds to start automatic preset tuning (see page 48).

**⑫ TUNING MODE (AUTO/MAN'L), DISPLAY**

Switches the tuning mode between automatic (the AUTO indicator is turned on) and manual (the AUTO indicator is turned off) when TUNER is selected as the input source.

**⑬ STRAIGHT (EFFECT)**

Turns the sound field programs on or off. When STRAIGHT is selected, 2-channel or multi-channel input signals are output directly from the respective speakers without effect processing.

**⑭ Remote control sensor**

Receives infrared signals from the remote control.

**⑮ TONE CONTROL**

Use to adjust the balance of bass and treble for the front left and right and center channels (see page 39).

**⑯ PURE DIRECT**

Turns on or off the PURE DIRECT mode (see page 42).

**Note**

The indicator around the button lights up when the unit is in the PURE DIRECT mode.

**⑰ REC OUT/ZONE 2**

Selects the input source you want to direct to the audio/video recorder and Zone 2 outputs independently of the input source you are listening to or watching in the main room. When set to the SOURCE/REMOTE position, the input source is directed to all outputs.

**Note**

The Zone 2 output is always identical with the input source you record.

**⑱ OPTIMIZER MIC jack**

Use to connect the supplied optimizer microphone to run AUTO SETUP (see page 32).

**⑲ SPEAKERS A/B**

Turn on or off the set of front speakers connected to the SPEAKERS A and/or B terminals on the rear panel each time the corresponding button is pressed.

**⑳ PHONES (SILENT CINEMA) jack**

Outputs audio signals for private listening with headphones.

**Notes**

- When you connect headphones, no signals are output at the PRE OUT jacks or to the speakers.
- All Dolby Digital and DTS audio signals are mixed down to 2-channel stereo (front left and right channels).

**㉑ VIDEO AUX jacks**

Input audio and video signals from an external source such as a game console. To reproduce source signals at these jacks, select V-AUX as the input source.

**㉒ MULTI ZONE buttons****ZONE 2 ON/OFF**

Turns on Zone 2 only or sets it to the standby mode. See page 30 for details.

**Note**

This button is operational only when MASTER ON/OFF is pressed inward to the ON position.

**ZONE 3 ON/OFF**

Turns on Zone 3 only or sets it to the standby mode. See page 30 for details.

**Note**

This button is operational only when MASTER ON/OFF is pressed inward to the ON position.

**ZONE CONTROL**

Switches the zone you want to control between the main unit, Zone 2 and Zone 3 (see page 117). After you press ZONE CONTROL, the indicator for the currently selected zone flashes in the front panel display for approximately 5 seconds. While the indicator is flashing, perform the desired operation.

**㉓ PROGRAM selector**

Use to select sound field programs or adjust the balance of bass and treble in conjunction with TONE CONTROL.

**㉔ VOLUME**

Controls the volume level of all audio channels.

**Note**

This does not affect the OUT (REC) level.

## Remote control

This section describes the function of each control on the remote control used to control this unit. Set AMP/SOURCE/TV to AMP to operate this unit. To operate other components, see “REMOTE CONTROL FEATURES” on page 103.

### Note

The XM Satellite Radio controls (XM, XM MEMORY, SRCH MODE, DISPLAY, cursor buttons  $\Delta$  /  $\nabla$  /  $\triangleleft$  /  $\triangleright$ , numeric buttons and ENT.) are only applicable to the U.S.A. model and are operational only when XM is selected as the input source. For details, see “Remote control functions” on page 54.

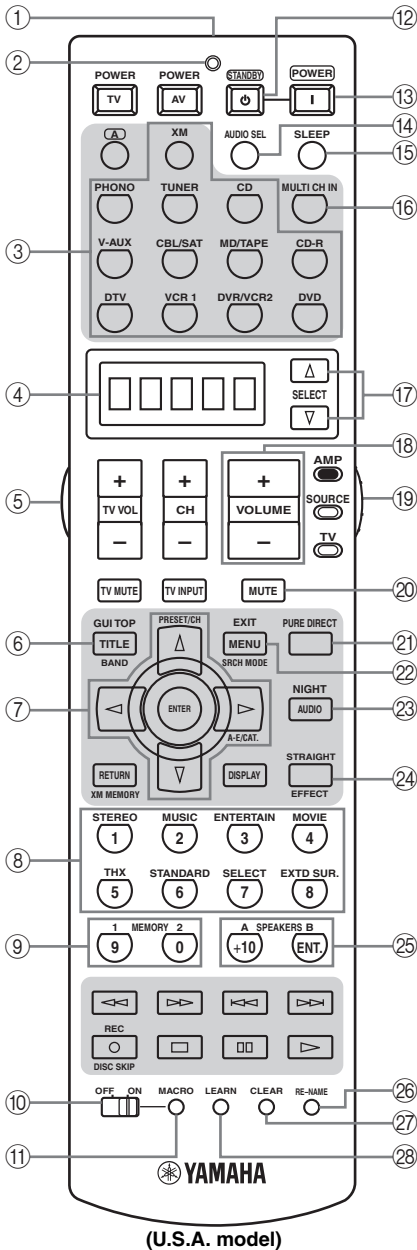

### ① Infrared window

Outputs infrared control signals. Aim this window at the component you want to operate.

### ② Transmission indicator

Flashes while the remote control is sending infrared signals.

### ③ Input selector buttons

Select the input source and change the control area. Set AMP/SOURCE/TV to SOURCE and then press TUNER to select TUNER as the input source. Set AMP/SOURCE/TV to SOURCE and then press XM to select XM as the input source.

### ④ Display window

Shows the name of the selected input source that you can control.

### ⑤ Light button

Press to light up the remote control buttons and the display window.

### ⑥ GUI TOP, BAND

Displays the top screen in the graphical user interface (GUI) menu on your video monitor when AMP/SOURCE/TV is set to AMP.

Switches the reception band between FM and AM when AMP/SOURCE/TV is set to SOURCE and TUNER is selected as the input source.

### ⑦ Cursor buttons $\Delta$ / $\nabla$ / $\triangleleft$ / $\triangleright$ , ENTER

Selects and adjusts the DSP program parameters or GUI menu items when AMP/SOURCE/TV is set to AMP. Press  $\triangleleft$  /  $\triangleright$  to select a preset station group (A to E) and  $\Delta$  /  $\nabla$  to select a preset station number (1 to 8) when AMP/SOURCE/TV is set to SOURCE and TUNER is selected as the input source.

### ⑧ Sound field program / numeric buttons

Select sound field programs when AMP/SOURCE/TV is set to AMP. Use SELECT to play back 2-channel sources in the multi-channel format (see page 41).

Use EXT D SUR. to switch between 5.1 and 6.1/7.1 channel playback of multi-channel software (see page 40). Use numbers 1 to 8 to select preset stations when AMP/SOURCE/TV is set to SOURCE and TUNER is selected as the input source.

### ⑨ MEMORY 1/2

Use to recall favorite sound field programs, YPAO settings or additional preset stations (see page 99).

### ⑩ MACRO ON/OFF

Turns on or off the macro function (see page 111).

**⑪ MACRO**

Programs a series of operations to be controlled with a single button (see page 110).

**⑫ STANDBY**

Sets this unit, Zone 2 and Zone 3 to the standby mode (see page 30).

**Note**

This button is operational only when MASTER ON/OFF on the front panel is pressed inward to the ON position.

**⑬ POWER**

Turns on this unit, Zone 2 and Zone 3 (see page 30).

**Note**

This button is operational only when MASTER ON/OFF on the front panel is pressed inward to the ON position.

**⑭ AUDIO SEL**

Toggles the priority for the type of audio input jack between AUTO, HDMI, COAX/OPT and ANALOG when one component is connected to two or more input jacks on the rear panel (see page 44).

**⑮ SLEEP**

Sets the sleep timer.

**⑯ MULTI CH IN**

Selects MULTI CH INPUT when using an external decoder, etc.

**⑰ SELECT  $\Delta$  /  $\nabla$** 

Selects another input source that you can control independently of the input source selected with the input selector buttons.

**⑱ VOLUME +/-**

Increases or decreases the volume level.

**⑲ AMP/SOURCE/TV**

Selects the component you want to control with the remote control.

**AMP**

Set to this position to operate this unit.

**SOURCE**

Set to this position to operate the component selected with an input selector button.

**TV**

Set to this position to operate the television assigned to either DTV or PHONO.

**Note**

If televisions are assigned to both DTV and PHONO, the one assigned to DTV takes priority and gets operated when AMP/SOURCE/TV is set to TV.



To set the remote control codes for other components, see page 105.

**⑳ MUTE**

Mutes the sound. Press again to restore the audio output to the previous volume level.

**㉑ PURE DIRECT**

Turns on or off the PURE DIRECT mode (see page 42).

**㉒ EXIT**

Exits the GUI mode.

**㉓ NIGHT**

Turns on or off the night listening modes (see page 42).

**㉔ STRAIGHT (EFFECT)**

Switches the sound field programs off or on. When STRAIGHT is selected, 2-channel or multi-channel input signals are output directly from their respective speakers without effect processing.

**㉕ SPEAKERS A/B**

Turns on or off the set of front speakers connected to the SPEAKERS A and/or B terminals on the rear panel each time the corresponding button is pressed.

**㉖ RE-NAME**

Changes the name of the input source in the display window (see page 109).

**㉗ CLEAR**

Clears remote control codes or functions acquired from the learn, macro and rename features (see page 112).

**㉘ LEARN**

Programs remote control codes or functions from other remote controls (see page 107).

## Zone 2/Zone 3 remote control

This section describes the function of each control on the Zone 2/Zone 3 remote control used to control Zone 2 or Zone 3.

### Note

The XM Satellite Radio controls (XM, DISPLAY, PRESET, ALL, CAT., numeric buttons, NUMBER, cursor buttons  $\Delta$  /  $\nabla$  /  $\triangleleft$  /  $\triangleright$  and ENT) are only applicable to the U.S.A. model and are operational only when XM is selected as the input source. For details, see "Zone 2/Zone 3 remote control functions" on page 55.

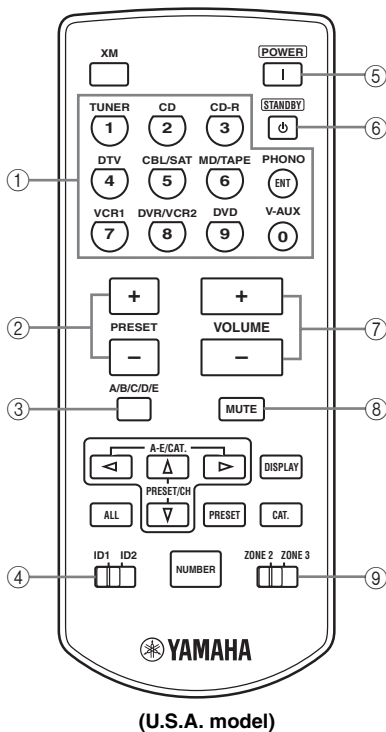

### ① Input selector buttons

Select the desired input source of Zone 2 or Zone 3 and change the control area.

### ② PRESET +/-

Selects the preset station number (1 to 8) when TUNER is selected as the input source or Zone 2 or Zone 3.

### ③ A/B/C/D/E

Selects the preset station group (A to E) when TUNER is selected as the input source or Zone 2 or Zone 3.

### ④ ID1/ID2 switch

Switches the remote control ID between ID1 and ID2 (see page 106).

### ⑤ POWER

Turns on Zone 2 or Zone 3.

### Note

This button is operational only when MASTER ON/OFF on the front panel is pressed inward to the ON position.

### ⑥ STANDBY

Sets Zone 2 or Zone 3 to the standby mode.

### Note

This button is operational only when MASTER ON/OFF on the front panel is pressed inward to the ON position.

### ⑦ VOLUME +/-

Increases or decreases the volume level of Zone 2 or Zone 3.

### ⑧ MUTE

Mutes the sound of Zone 2 or Zone 3.

Press again to restore the audio output to the previous volume level.

### ⑨ ZONE 2/ZONE 3 switch

Switches between the operation mode of Zone 2 and that of Zone 3.

# Front panel display

**Note**

The XM indicator is only applicable to the U.S.A. model.

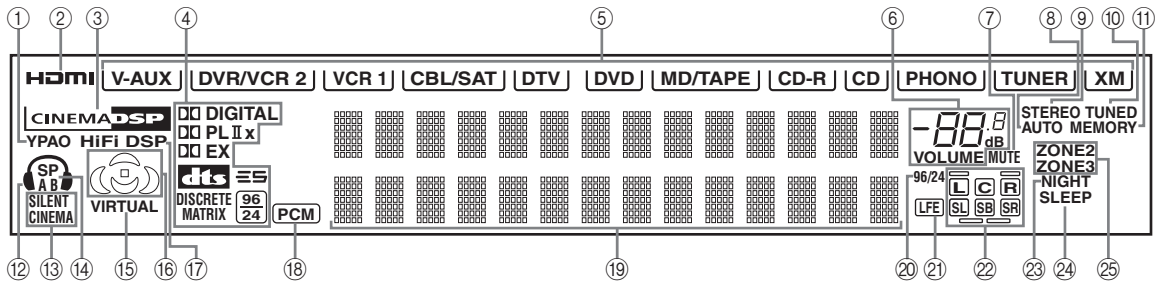

**① YPAO indicator**

Lights up when the AUTO SETUP procedure is in progress and when the AUTO SETUP speaker settings are used without any modifications.

**② HDMI indicator**

Lights up when HDMI components are assigned to the HDMI IN 1 and HDMI IN 2 jacks and they are recognized by this unit.

Turns off when no HDMI component is assigned to the either HDMI IN 1 or HDMI IN 2 jack or when no HDMI component is recognized by this unit although they are assigned to the HDMI IN jacks. See page 119 for details.

**③ CINEMA DSP indicator**

Lights up when you select a CINEMA DSP sound field program.

**④ Decoder indicators**

When any of the decoders of this unit operate, the respective indicator lights up.

**⑤ Input source indicators**

Light up when the corresponding input source is selected.

**⑥ VOLUME level indicator**

Indicates the volume level.

**⑦ MUTE indicator**

Flashes while the MUTE function is on.

**⑧ AUTO indicator**

Lights up when this unit is in the automatic tuning mode.

**⑨ STEREO indicator**

Lights up when this unit is receiving a stereo signal for an FM stereo broadcast while the AUTO indicator is lit.

**⑩ TUNED indicator**

Lights up when this unit is tuned into a station.

**⑪ MEMORY indicator**

Flashes to indicate that a station can be stored.

**⑫ Headphones indicator**

Lights up when headphones are connected.

**⑬ SILENT CINEMA indicator**

Lights up when headphones are connected and a sound field program is selected (see page 39).

**⑭ SP A B indicators**

Light up according to the set of front speakers selected. Both indicators light up when both sets of front speakers are selected or when bi-wiring.

**⑮ VIRTUAL indicator**

Lights up when Virtual CINEMA DSP is active (see page 44).

**⑯ Sound field indicators**

Light up to indicate the active DSP sound fields.

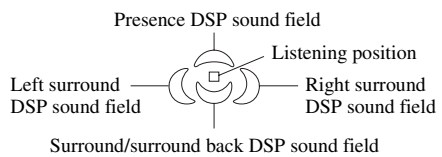

**⑰ HiFi DSP indicator**

Lights up when you select a HiFi DSP sound field program.

**⑱ PCM indicator**

Lights up when this unit is reproducing PCM (pulse code modulation) digital audio signals.

**⑲ Multi-information display**

Shows the name of the current sound field program and other information when adjusting or changing settings.

⑳ **96/24 indicator**

Lights up when a DTS 96/24 signal is input to this unit.

㉑ **LFE indicator**

Lights up when the input signal contains an LFE signal.

㉒ **Input channel and speaker indicators**

**Input channel indicators**

Indicate the channel components of the current digital input signal.



**Presence and surround back speaker indicators**

Light up according to the number of presence and surround back speakers set for Presence (see page 92) and Surround Back (see page 91) in Manual Setup when Test Tone in Manual Setup is set to On (see page 90).



You can make settings for the presence and surround back speakers automatically by running Auto Setup (see page 32) or manually by adjusting settings for Presence (see page 92) and Surround Back (see page 91) in Manual Setup.

㉓ **NIGHT indicator**

Lights up when you select a night listening mode.

㉔ **SLEEP indicator**

Lights up while the sleep timer is on.

㉕ **ZONE 2/ZONE 3 indicators**

Light up when Zone 2 or Zone 3 is turned on.



## Rear panel

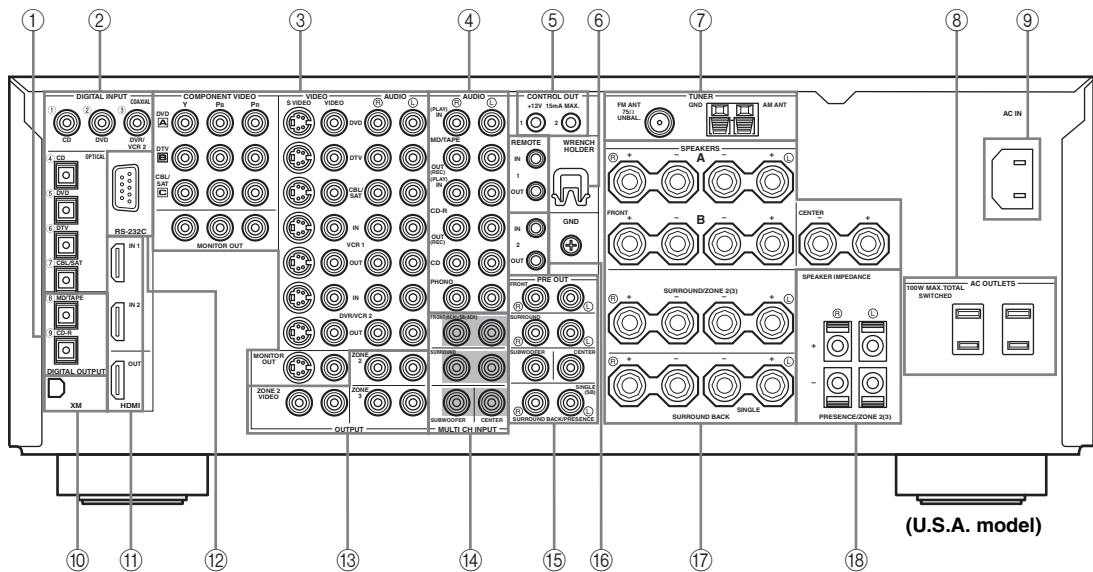

### ① DIGITAL OUTPUT jacks

See pages 24, 25 and 27 for connection information.

### ② DIGITAL INPUT jacks

See pages 24, 25 and 27 for details.

### ③ Video component jacks

See pages 24 and 25 for connection information.

### ④ Audio component jacks

See pages 24, 25 and 27 for connection information.

### ⑤ CONTROL OUT jacks

These are control expansion terminals for factory use only.

### ⑥ WRENCH HOLDER

Use to hook the supplied speaker terminal wrench when not in use (see page 16).

### ⑦ Antenna terminals

See page 29 for connection information.

### ⑧ AC OUTLETS

Use to supply power to your other A/V components (see page 30).

### ⑨ AC IN

Use this inlet to plug in the supplied power cable (see page 30).

### ⑩ XM jack (U.S.A. model only)

See page 53 for connection information.

### ⑪ HDMI IN/OUT connectors

See page 119 for connection information.

### ⑫ RS-232C terminal

This is a control expansion terminal for factory use only. Consult your dealer for details.

### ⑬ ZONE 2/ZONE 3 OUTPUT jacks

See page 115 for details.

### ⑭ MULTI CH INPUT jacks

See page 26 for connection information.

### ⑮ PRE OUT jacks

See page 28 for connection information.

### ⑯ REMOTE 1/2 IN/OUT jacks

See page 115 for details.

### ⑰ Speaker terminals

See page 15 for connection information.

### ⑱ PRESENCE/ZONE 2(3) speaker terminals

See page 17 for connection information.

# CONNECTIONS

## Before connecting speakers

The speaker layout below shows the standard ITU-R\* speaker setting. You can use it to enjoy CINEMA DSP, multi-channel audio sources and THX.

\* ITU-R is the radio communication sector of the ITU (International Telecommunication Union).

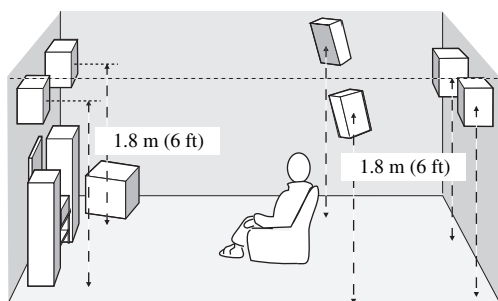
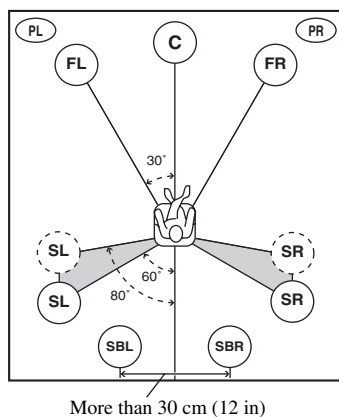

### Front speakers (FR and FL)

The front speakers are used for the main source sound plus effect sounds. Place these speakers an equal distance from the ideal listening position. The distance of each speaker from each side of the video monitor should be the same.

### Center speaker (C)

The center speaker is for the center channel sounds (dialog, vocals, etc.). If for some reason it is not practical to use a center speaker, you can do without it. Best results, however, are obtained with the full system. Align the front face of the center speaker with the front face of your video monitor. Place the speaker centrally between the front speakers and as close to the monitor as possible, such as directly over or under it.

### Surround speakers (SR and SL)

The surround speakers are used for effect and surround sounds. Place these speakers behind your listening position, facing slightly inwards, about 1.8 m (6 ft) above the floor.

### Surround back speakers (SBR and SBL)

The surround back speakers supplement the surround speakers and provide for more realistic front-to-back transitions. Place these speakers directly behind the listening position and at the same height as the surround speakers. They should be positioned at least 30 cm (12 in) apart. Ideally, they should be positioned at the same width as the front speakers.

### Subwoofer

The use of a subwoofer, such as the YAMAHA Active Servo Processing Subwoofer System, is effective not only for reinforcing bass frequencies from any or all channels, but also for high fidelity reproduction of the LFE (low-frequency effect) channel included in Dolby Digital and DTS software. The position of the subwoofer is not so critical, because low bass sounds are not highly directional. But it is better to place the subwoofer near the front speakers. Turn it slightly toward the center of the room to reduce wall reflections.

### Presence speakers (PR and PL)

Presence speakers supplement the sound from the front speakers with extra ambient effects produced by CINEMA DSP (see page 65). These effects include sounds that filmmakers intend to locate a little farther back behind the screen in order to create more theater-like ambience. Place these speakers at the front of the room about 0.5 – 1 m (1 – 3 ft) outside the front speakers, facing slightly inwards, and about 1.8 m (6 ft) above the floor.

### Note

Surround back and presence speakers do not output sound simultaneously. You can set to prioritize either set of speakers using the PR/SB Priority parameter in Manual Setup (see page 86).

## ■ Di-pole speaker layout

Either di-pole or direct radiating speaker types can be used for THX surround. If you choose di-pole speakers, please place the surround and surround back speakers according to the speaker layout below.

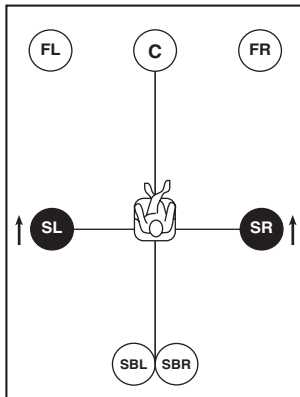

● : Di-pole speaker

↑ : Direction of the di-pole speaker phase

## Connecting speakers

Be sure to connect the left channel (L), right channel (R), “+” (red) and “-” (black) properly. If the connections are faulty, no sound will be heard from the speakers, and if the polarity of the speaker connections is incorrect, the sound will be unnatural and lack bass.

### CAUTION

- If you will use 6 ohm speakers, be sure to set this unit’s speaker impedance setting to 6 ohms before using (see page 31). If you will use 8 ohm speakers, use this unit’s initial setting for speaker impedance.
- Before connecting the speakers, make sure that this unit is disconnected from the power source.
- Do not let the bare speaker wires touch each other or do not let them touch any metal part of this unit. This could damage this unit and/or speakers.
- Use magnetically shielded speakers. If this type of speaker still creates interference with the monitor, place the speakers away from the monitor.

### Note

A speaker cord is actually a pair of insulated cables running side by side. One cable is colored or shaped differently, perhaps with a stripe, groove or ridges. Connect the striped (grooved, etc.) cable to the “+” (red) terminals on this unit and your speaker. Connect the plain cable to the “-” (black) terminals.

## ■ Connecting to the speaker terminals

### FRONT terminals

Connect one or two speaker systems to these terminals. If you use only one speaker system, connect it to either of the FRONT A or B terminals.

### Note

The Canada model cannot output to two pairs of speaker systems simultaneously.

### CENTER terminals

Connect a center speaker to these terminals.

### SURROUND ZONE 2(3) terminals

Connect surround speakers to these terminals.

### SUBWOOFER jack

Connect a subwoofer with a built-in amplifier, such as the YAMAHA Active Servo Processing Subwoofer System, to this jack.

### SURROUND BACK terminals

Connect surround back speakers to these terminals. If you only connect one surround back speaker, connect it to the left (L) terminals.

- 1 Remove approximately 10 mm (3/8 in) of insulation from each of the speaker cables.

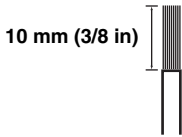

- 2 Twist the exposed wires of the cable together to prevent short circuits.



- 3 Loosen the knob using the supplied speaker terminal wrench.

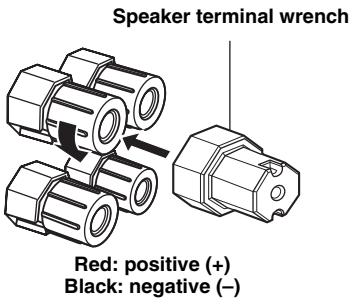

- 4 Insert one bare wire into the hole on the side of each terminal.

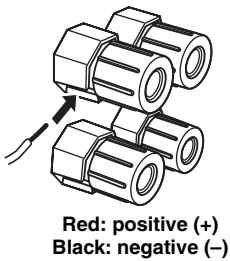

- 5 Tighten the knob to secure the wire using the supplied speaker terminal wrench.

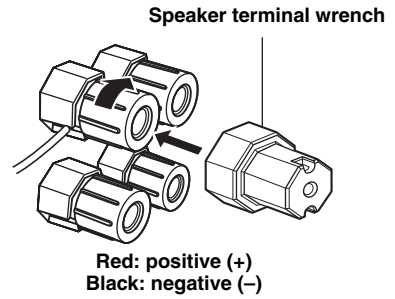

- 6 Hook the speaker terminal wrench onto WRENCH HOLDER on the rear panel of this unit when not in use.

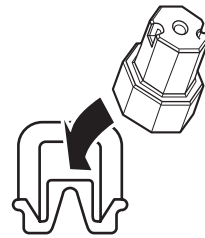

### PRESENCE/ZONE 2(3) terminals

Connect presence speakers to these terminals.

**Note**

You can also use these terminals to connect the Zone 2 speakers (see page 116).

**1 Open the tab.**

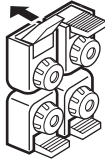

**2 Insert one bare wire into the hole of each terminal.**

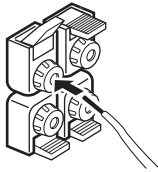

**3 Return the tab to secure the wire.**

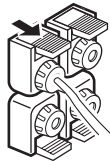

### ■ Connecting the banana plug

(With the exception of U.K., Europe and Asia models)  
First, tighten the knob and then insert the banana plug connector into the end of the corresponding terminal.

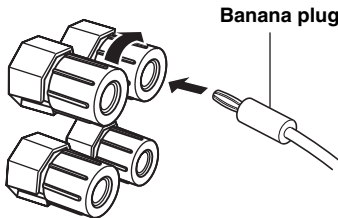

(With the exception of U.K., Europe and Asia models)



You can also use banana plugs with the PRESENCE/ZONE 2(3) speaker terminals. Open the tab and then insert one banana plug connector into the hole of each terminal. Do not attempt to close the tabs after connecting the banana plugs.

### ■ Speaker layout

Refer to the following illustration as to where to place each speaker in your listening room.

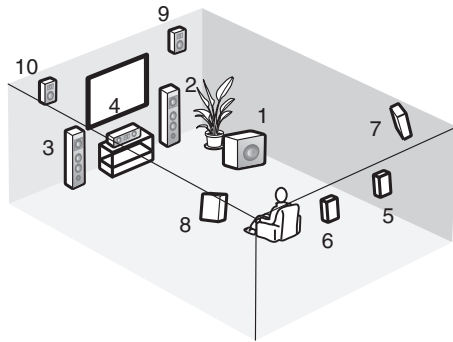

- 1 Subwoofer
- 2 Front right speaker
- 3 Front left speaker
- 4 Center speaker
- 5 Surround back right speaker
- 6 Surround back left speaker
- 7 Surround right speaker
- 8 Surround left speaker
- 9 Presence right speaker
- 10 Presence left speaker



## Using bi-wire and bi-AMP connections

Some of the speakers commercially available these days have speaker wire connections that allow bi-wiring or bi-amplification to enhance the performance of the speaker system. This unit allows you to make bi-wire and bi-AMP connections to one speaker system. Check if your speakers support bi-wiring or bi-amplification. As these speakers are shipped to you, you will note gold-plated shorting bars or bridges, one connecting the two red input terminals and the other connecting the two black input terminals. Remove these shorting bars or bridges only if you plan to bi-wire or bi-AMP your speakers.

### Conventional connection

If you want to connect your speakers as traditional loudspeakers using the conventional connection method, connect your speakers using the regular left and right speaker wire connections and ignore the second set of terminals.

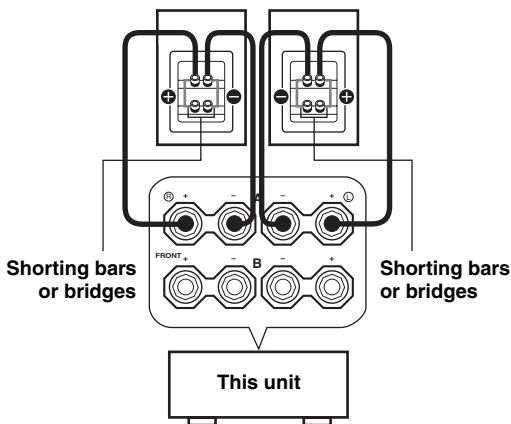

### Bi-wire connection

The bi-wire connection separates the woofer from the combined midrange and tweeter section. A bi-wire compatible speaker has four binding post terminals. These two sets of terminals allow the speaker to be split into two independent sections. This split connects the mid and high frequency drivers to one set of terminals and the low frequency driver to the other pair.

#### Notes

- Remove the shorting bars or bridges to separate the LPF (low pass filter) and HPF (high pass filter) crossovers.
- To use the bi-wire connections, press SPEAKERS A on the front panel so that SP A lights up in the front panel display.

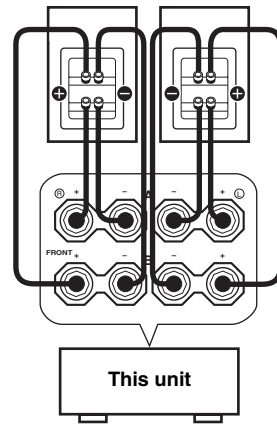

### Bi-AMP connection

The bi-AMP connection uses two amplifiers for both speakers. One amplifier is connected to the woofer section of a loudspeaker while the other is connected to the combined mid and tweeter section. With this arrangement each amplifier operates over a restricted frequency range. This restricted range presents each amplifier with a much simpler job and each amplifier is less likely to influence the sound in some way. The internal crossover of the speaker consists of a LPF (low pass filter) and a HPF (high pass filter). As its name implies, the LPF passes frequencies below a cutoff and rejects frequencies above the cutoff frequency. Likewise, the HPF passes frequencies above its cutoff.

#### Notes

- Remove the shorting bars or bridges to separate the LPF (low pass filter) and HPF (high pass filter) crossovers.
- To activate the bi-AMP connections, set BI-AMP to ON in ADVANCED SETUP (see page 102).
- To make the bi-AMP connections, use the FRONT and SURROUND BACK terminals as shown below.

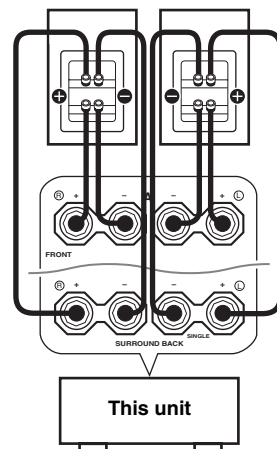

## Information on cables and jacks used for connections

### CAUTION

Do not connect this unit or other components to the main power until all connections between components are complete.

### ■ Cable indications

#### For analog signals

left analog cables



right analog cables



#### For digital signals

optical cables



coaxial cables



#### For video signals

video cables



S-video cables



#### For HDMI signals



### ■ Analog jacks

You can input analog signals from audio components by connecting audio pin cables to the analog jacks on this unit. Connect red plugs to the right jacks and white plugs to the left jacks.

### ■ Digital jacks

This unit has digital jacks for direct transmission of digital signals through either coaxial or fiber optic cables. You can use the digital jacks to input PCM, Dolby Digital and DTS bitstreams. When you connect components to both the COAXIAL and OPTICAL jacks, priority is given to signals input at the COAXIAL jack. All digital input jacks are compatible with 96-kHz sampling digital signals.

### Note

This unit handles digital and analog signals independently. Thus audio signals input at the analog jacks are only output at the analog OUT (REC) jacks. Likewise, audio signals input at the digital (OPTICAL or COAXIAL) jacks are only output at the DIGITAL OUTPUT jacks.



## ■ Audio jacks

This unit has four types of audio jacks (analog audio, digital audio coaxial, digital audio optical and HDMI). Connection depends on the availability of audio jacks on your other components.



### AUDIO jacks

For conventional analog audio signals.

### DIGITAL AUDIO (COAXIAL) jacks

For digital audio signals transmitted via digital coaxial cables.

### DIGITAL AUDIO (OPTICAL) jacks

For digital audio signals transmitted via digital optical cables.

### HDMI jacks

For HDMI digital audio signals.

## ■ Audio signal flow for OUT (REC)

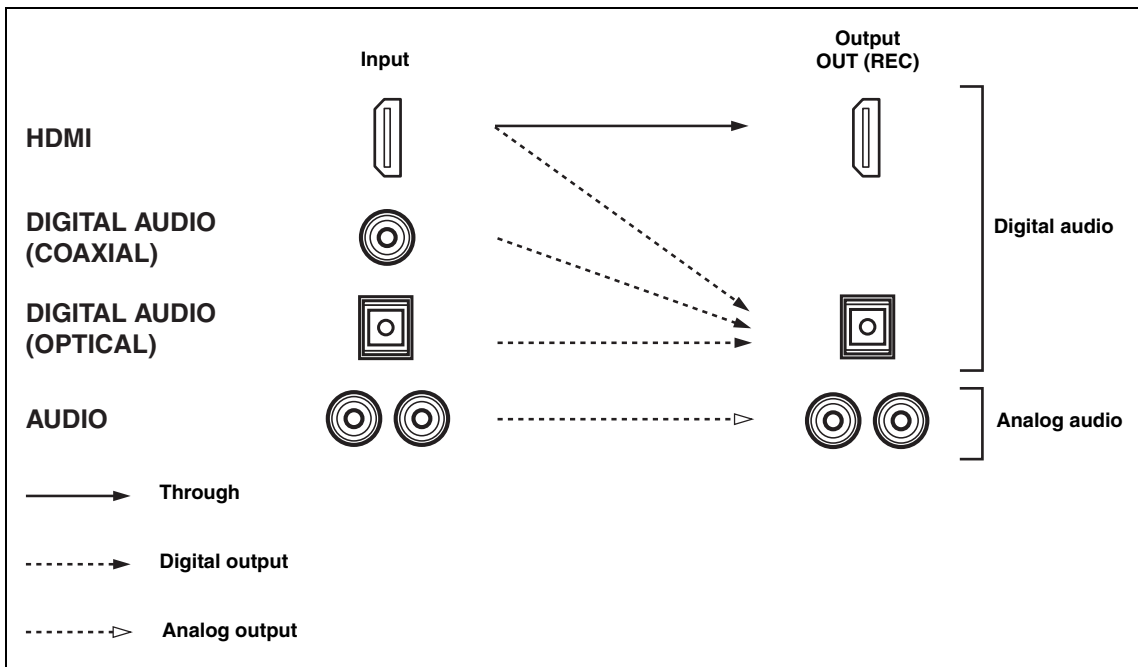

### Notes

- The audio signals input at the HDMI IN 1 or HDMI IN 2 jack are output at the DIGITAL OUTPUT jacks only and are not output at the analog OUT (REC) jacks.
- 2-channel as well as multi-channel PCM, Dolby Digital and DTS signals input at the HDMI IN 1 or HDMI IN 2 jack can be output at the HDMI OUT jack only when HDMI Set is set to Other (see page 99).
- 2-channel PCM, Dolby Digital and DTS signals except multi-channel PCM signals input at the HDMI IN 1 or HDMI IN 2 jack can be output at the DIGITAL AUDIO (OPTICAL) jacks.
- Copy-protected 2-channel PCM signals with over 48 kHz/16 bit input at the HDMI IN 1 or HDMI IN 2 jack are not output at the DIGITAL AUDIO (OPTICAL) jacks.

**Video jacks**

This unit has four types of video jacks (composite, component, S-video and HDMI). Connection depends on the availability of input jacks on your monitor. When Conversion is set to On (see page 88), the analog video signals input at the VIDEO, S VIDEO and COMPONENT VIDEO jacks can be output at the VIDEO, S VIDEO and COMPONENT VIDEO jacks interchangeably. In addition, when Conversion is set to On (see page 88) and HDMI Up-Scaling is set to On (see page 88), the analog video signals input at the VIDEO, S VIDEO and COMPONENT VIDEO jacks can be digitally up-converted and output at the HDMI OUT jack.

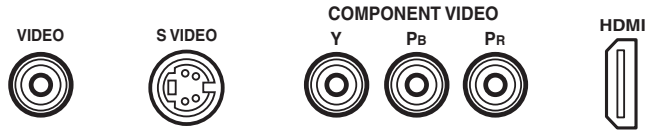

**VIDEO jacks**

For conventional composite video signals.

**S VIDEO jacks**

For S-video signals, separated into luminance (Y) and color (C) video signals to achieve high-quality color reproduction.

**COMPONENT VIDEO jacks**

For component signals, separated into luminance (Y) and color difference (Pb, Pr) to provide the best quality in picture reproduction.

**HDMI jacks**

For HDMI digital video signals.

**Video signal flow for MONITOR OUT**

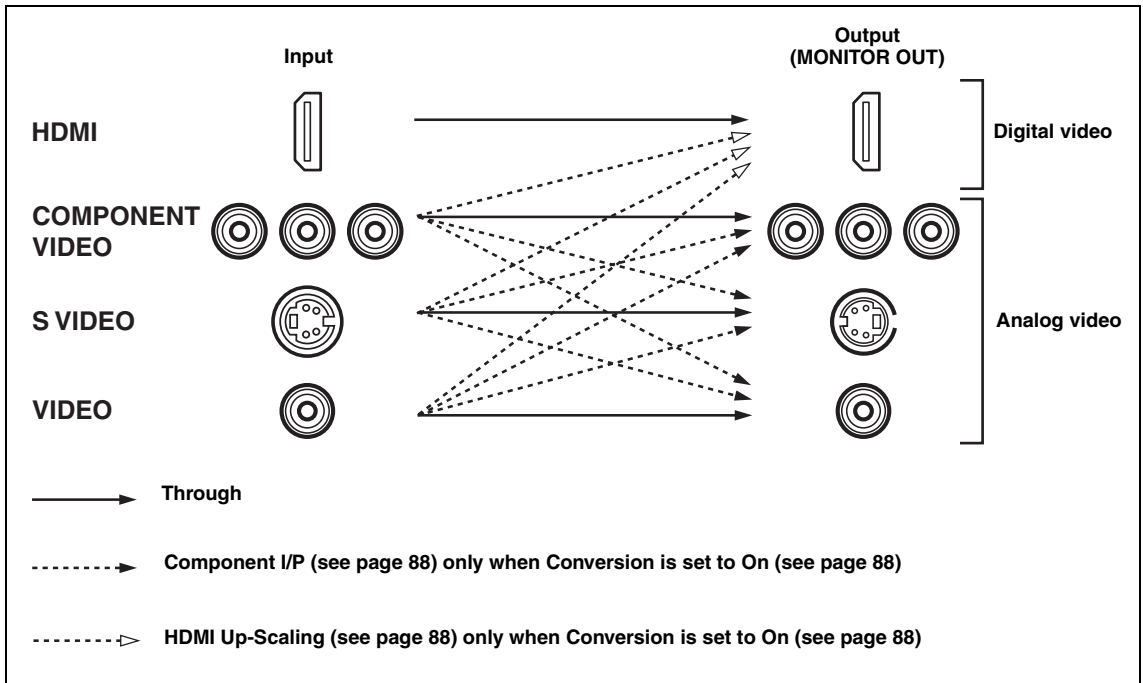

**Notes**

- The analog video signals output at the COMPONENT VIDEO jacks can be deinterlaced from 480i to 480p. Set Component I/P to On in Manual Setup to activate this feature (see page 88).
- The analog video signals input at the COMPONENT VIDEO jacks and output at the S VIDEO or VIDEO jacks cannot be converted to 480p/1080i/720p.
- The analog video signals output at the HDMI jack can be up-scaled to 480p/1080i/720p.
- When the analog video signals are input at the COMPONENT VIDEO, S VIDEO and VIDEO jacks, the priority order of the input signals is as follows where the analog video signals input at the COMPONENT VIDEO jacks have the top priority.
  1. COMPONENT VIDEO
  2. S VIDEO
  3. VIDEO

## Connecting HDMI components

This unit has the HDMI IN 1 and HDMI IN 2 jacks for digital audio and video signal input as well as the HDMI OUT jack for digital audio and video signal output. Connect the HDMI IN 1 or HDMI IN 2 jack of this unit to the HDMI OUT jack of other HDMI components (such as a DVD player). Connect the HDMI OUT jack of this unit to the HDMI IN jack of other HDMI components (such as a TV and a projector).

The video or audio signals input at the HDMI IN 1 or HDMI IN 2 jack you selected using the HDMI IN menu in I/O Assignment (see page 81) or the INPUT selector on the front panel are output at the HDMI OUT jack of this unit. In addition, the audio signals input at the HDMI IN 1 or HDMI IN 2 jack are output to speakers, headphones and the DIGITAL OUTPUT jacks.

### Notes

- We recommend using an HDMI cable shorter than 5 meters (16 feet) with the HDMI logo printed on it.
- Digital audio signals input at the HDMI IN jacks are not output at the analog AUDIO OUT jacks.
- Some audio signals may not be output at the DIGITAL OUTPUT jacks depending on the signal type.
- The analog video signals input at the composite video, S-video and component video jacks can be digitally up-converted and up-scaled to 480p/1080i/720p to be output at the HDMI OUT jack. Set Conversion to On in Manual Setup (see page 88) and adjust settings for HDMI Up-Scaling to activate this feature (see page 88).
- Some video monitors connected to this unit via a DVI connection fail to recognize the HDMI audio signals being input if they are in the standby mode. In this case, the HDMI indicator flashes irregularly and HDCP ERROR appears in the front panel display as if the DVI monitors do not support the HDCP copy protection standards.

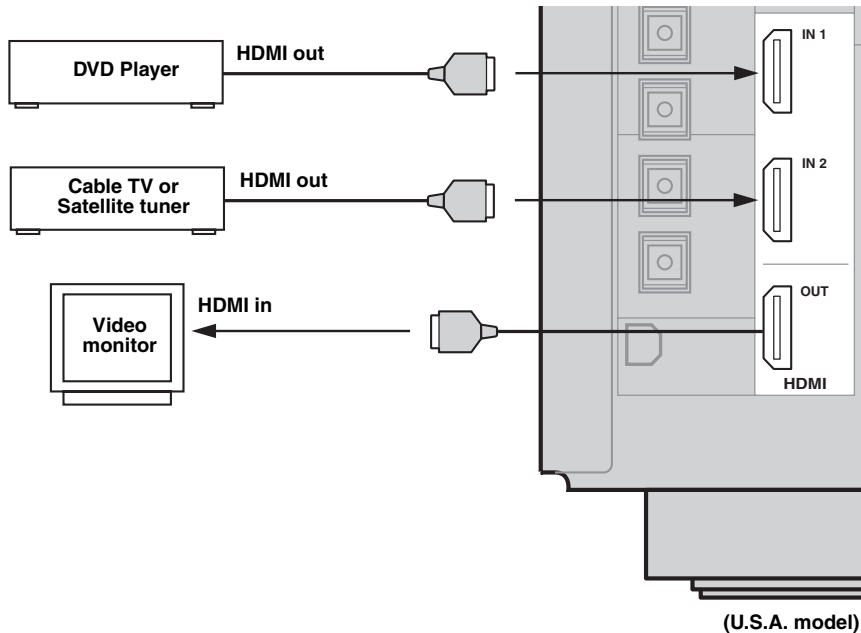

## Connecting video components

### ■ Connecting a DVD player

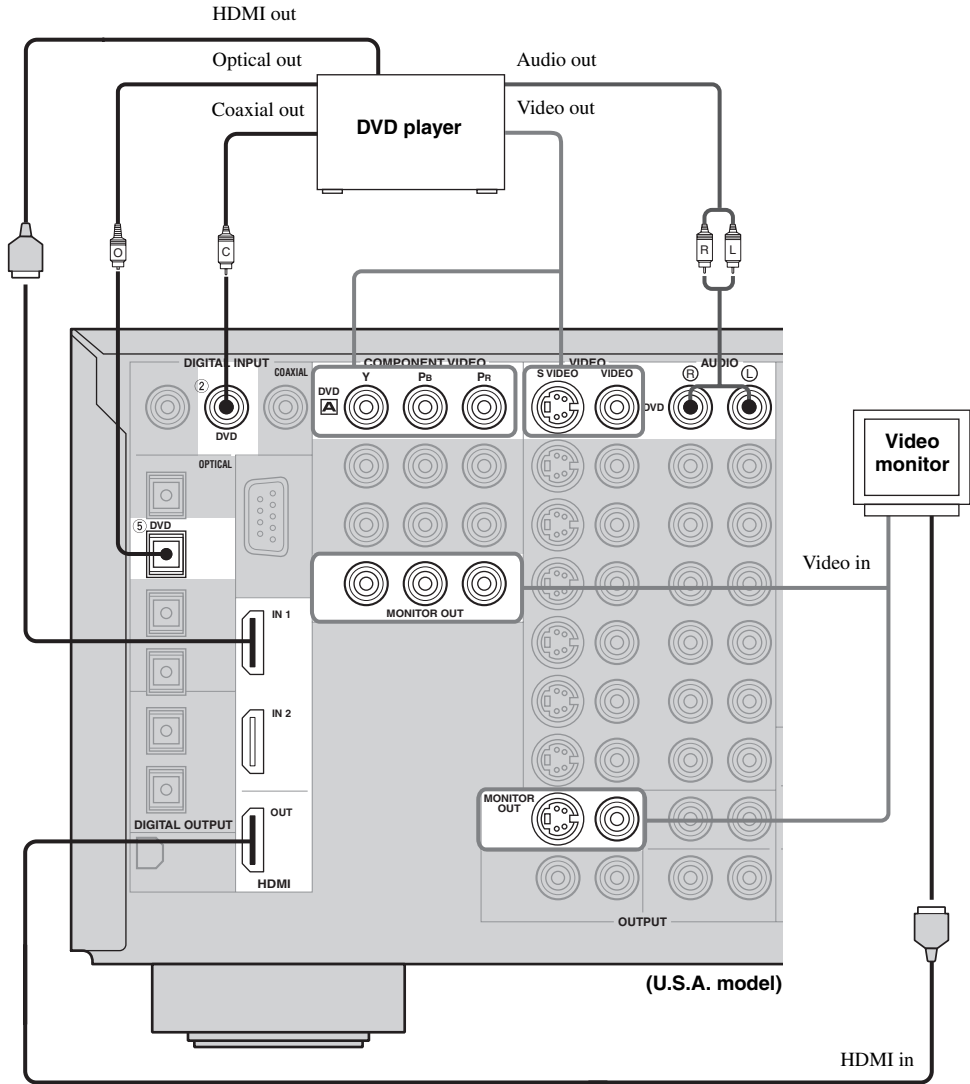

**Note**

Check the availability of jacks on your DVD player and select one type of connection for audio/video input/output. However, in case you make an HDMI connection, you can make both audio and video connections using a single HDMI cable.

■ Connecting other video components

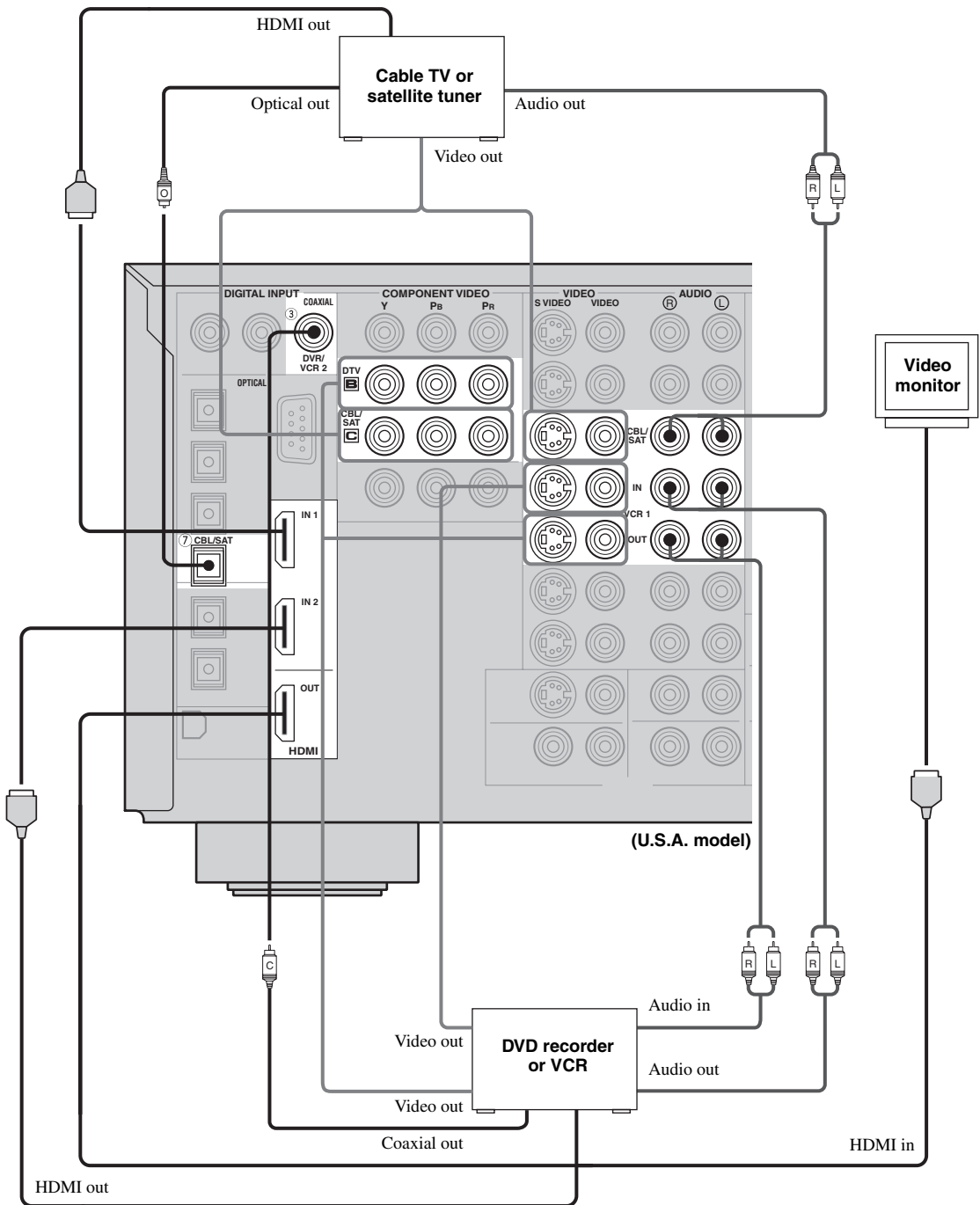

PREPARATION

**Note**

Check the availability of jacks on your other video components and select one type of connection for audio/video input/output. However, in case you make an HDMI connection, you can make both audio and video connections using a single HDMI cable.

**■ Connecting to the MULTI CH INPUT jacks**

This unit is equipped with 6 additional input jacks (left and right FRONT, CENTER, left and right SURROUND and SUBWOOFER) for discrete multi-channel input from a multi-format player, external decoder, sound processor or pre-amplifier.

If you set INPUT CH to 8ch in Multi CH Assign (see page 82), you can use the input jacks assigned as FRONT INPUT in Multi CH Assign (see page 82) together with the MULTI CH INPUT jacks to input 8-channel signals.

Connect the output jacks on your multi-format player or external decoder to the MULTI CH INPUT jacks. Be sure to match the left and right outputs to the left and right input jacks for the front and surround channels.

**For 6-channel input**

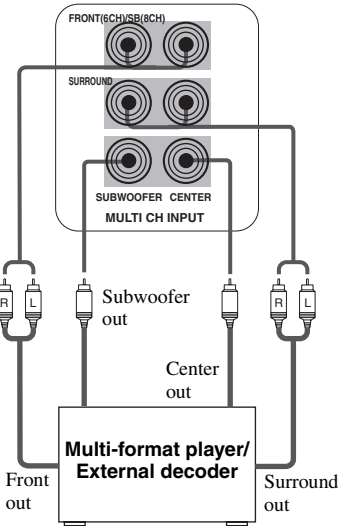

**For 8-channel input**

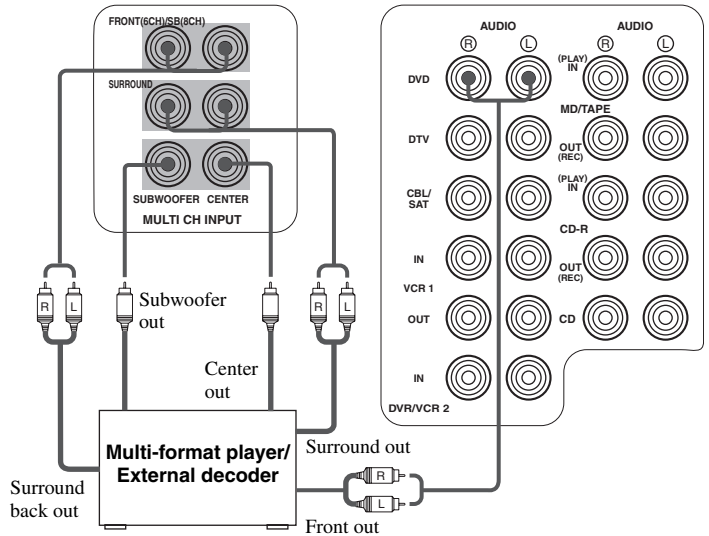

**Notes**

- When you select MULTI CH INPUT as the input source, this unit automatically turns off the digital sound field processor, and you cannot select sound field programs.
- This unit does not redirect signals input at the MULTI CH INPUT jacks to accommodate for missing speakers. We recommend that you connect at least a 5.1-channel speaker system before using this feature.
- When headphones are used, only front L/R channels are output.

**■ Connecting to the VIDEO AUX jacks on the front panel**

Use these jacks to connect any video source, such as a game console or video camera, to this unit.

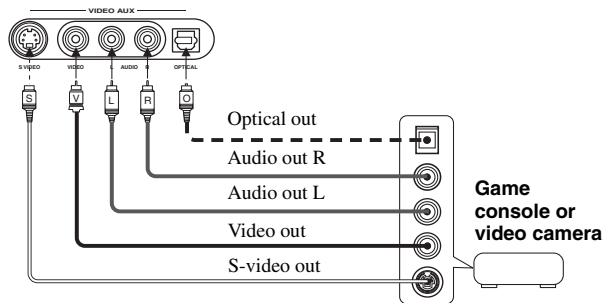

## Connecting audio components

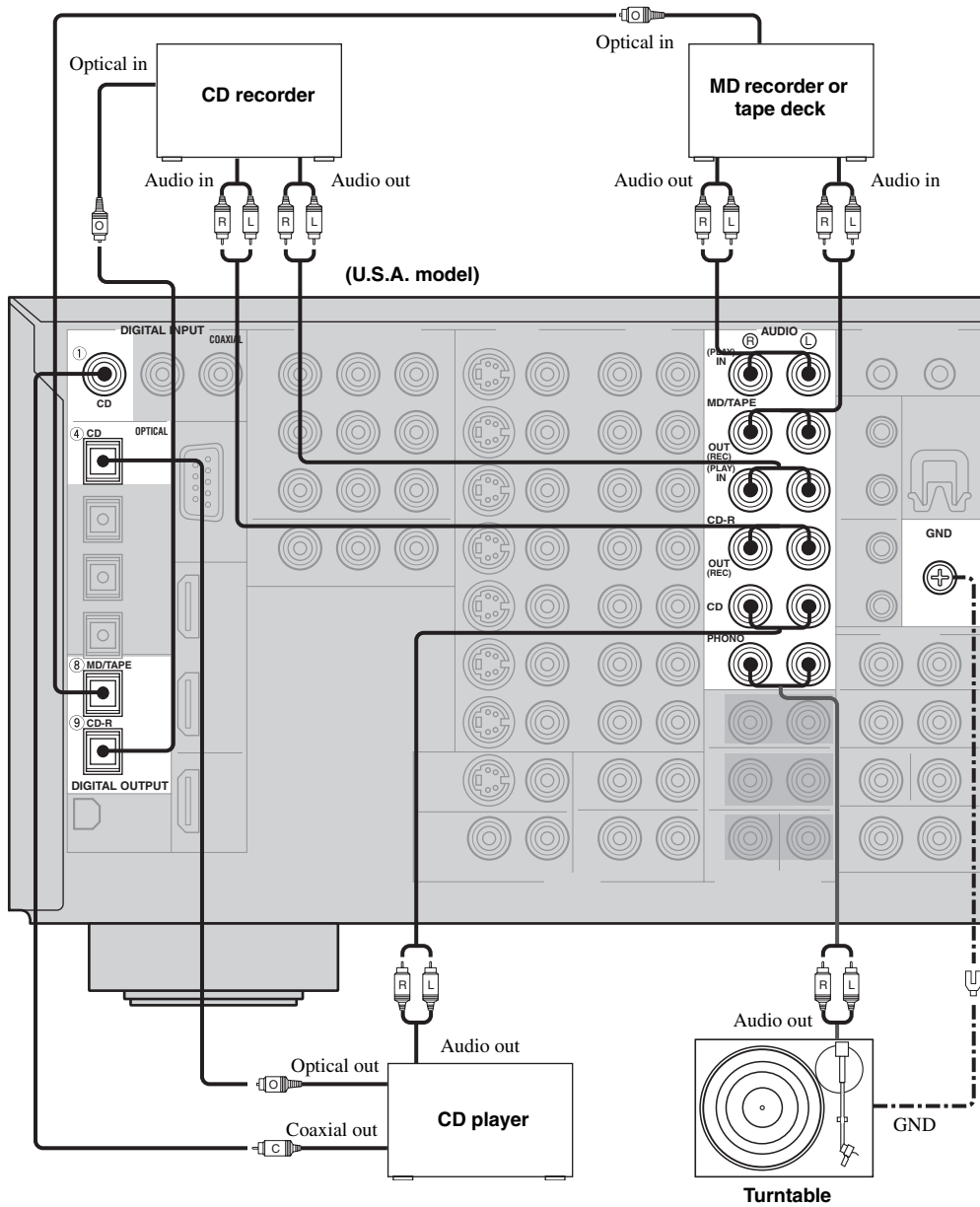

PREPARATION

### Notes

- Check the availability of jacks on your audio components and select one type of connection for audio/video input/output.
- PHONO jacks are for connecting a turntable with an MM or high-output MC cartridge. If you have a turntable with a low-output MC cartridge, use an in-line boosting transformer or MC-head amplifier when connecting to these jacks.
- Connect your turntable to the GND terminal to reduce noise in the signal. However you may hear less noise without the connection to the GND terminal for some record players.

## ■ Connecting an external amplifier

If you want to increase the power output to the speakers, or want to use another amplifier, connect an external amplifier to the PRE OUT jacks as follows.

### Notes

- When audio pin plugs are connected to the PRE OUT jacks for output to an external amplifier, it is not necessary to use the corresponding SPEAKERS terminals. Set the volume of the external amplifier connected to this unit to the maximum.
- The signal output at the FRONT PRE OUT and CENTER PRE OUT jacks are affected by the TONE CONTROL settings.
- If SPEAKERS A is turned off and SPEAKERS B is set to Zone B (see page 95), signals will only be output at the FRONT PRE OUT jacks.

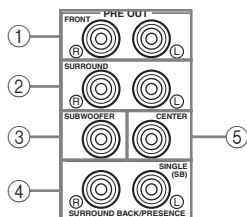

#### ① FRONT PRE OUT jacks

Front channel line output jacks.

#### ② SURROUND PRE OUT jacks

Surround channel line output jacks.

#### ③ SUBWOOFER PRE OUT jack

Connect a subwoofer with built-in amplifier, such as the YAMAHA Active Servo Processing Subwoofer System, to this jack.

#### ④ SURROUND BACK/PRESENCE PRE OUT jacks

Surround back or presence channel line output jacks. If you only connect one external amplifier for the surround back channel, connect it to the left (L) jack.

#### ⑤ CENTER PRE OUT jack

Center channel line output jack.

### Notes

- Each PRE OUT jack outputs the same channel signal as the corresponding speaker terminals. However, when both surround back and presence speakers are setup in this unit, the signals output at SURROUND BACK/PRESENCE PRE OUT jacks may not correspond to the correct speakers.
- Adjust the volume level of the subwoofer with the control on the subwoofer.
- Some signals may not be output at the SUBWOOFER PRE OUT jack depending on the Speaker Set settings (see page 90).



## Connecting the antennas

Both AM and FM indoor antennas are included with this unit. In general, these antennas should provide sufficient signal strength. Connect each antenna correctly to the designated terminals.

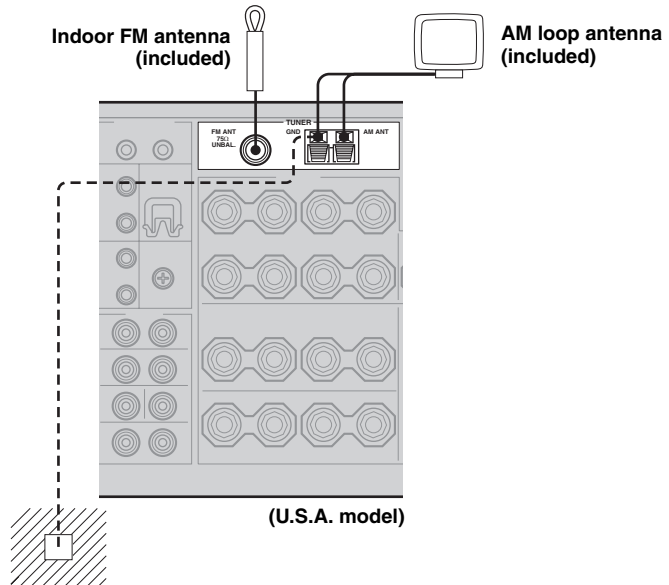

### ■ Connecting the AM loop antenna

#### 1 Set up the AM loop antenna.

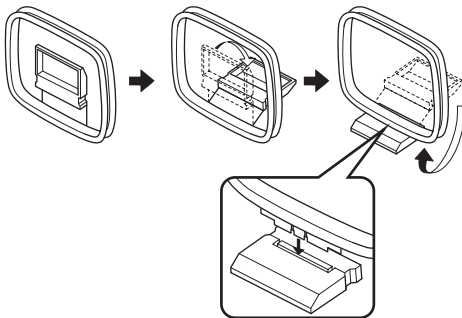

#### 3 Orient the AM loop antenna for the best reception.

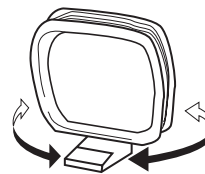

#### 2 Press and hold the tab to insert the AM loop antenna lead wires into the AM ANT and GND terminals.

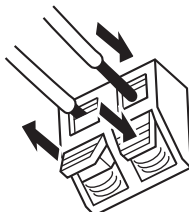

#### Notes

- The AM loop antenna should be placed away from this unit.
- The AM loop antenna should always be connected, even if an outdoor AM antenna is connected to this unit.
- A properly installed outdoor antenna provides clearer reception than an indoor one. If you experience poor reception quality, an outdoor antenna may improve the quality. Consult the nearest authorized YAMAHA dealer or service center about outdoor antennas.

## Connecting the power cable

### ■ Connecting the AC power cable

Plug the supplied AC power cable into the AC inlet after all other connections are complete and then plug the AC power cable to an AC wall outlet.

#### CAUTION

Use the supplied AC cable. Do not use other AC power cables as doing so may result in fire hazard or electrical shock.

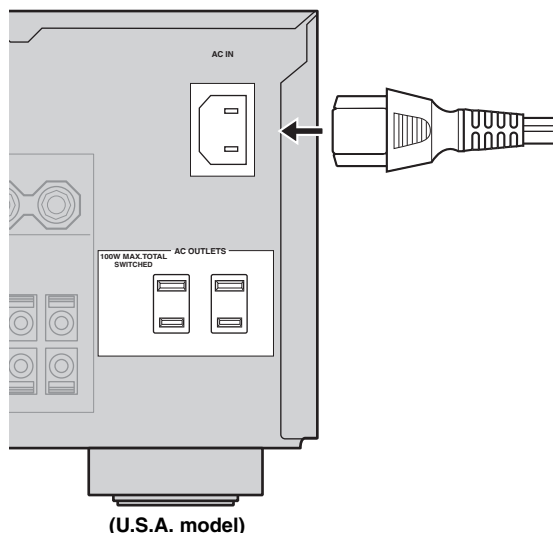

### ■ AC OUTLETS (SWITCHED)

Use these 2 outlets to supply power to any connected components. Connect the AC power cables of your other components to these 2 outlets. Power to these 2 outlets is supplied when the main room, Zone 2 or Zone 3 is turned on. However, power to these 2 outlets is cut off when the main room, Zone 2 and Zone 3 are turned off or when MASTER ON/OFF on the front panel is pressed and released outward to the OFF position. The maximum power or the total power consumption of the components that can be connected to these 2 outlets is 100 W.

#### Memory back-up

The memory back-up circuit prevents the stored data from being lost. However, the stored data will be lost in case the power cord is disconnected from the AC wall outlet for more than one week.

## Turning on and off this unit

When all connections are complete, turn on the power of this unit.

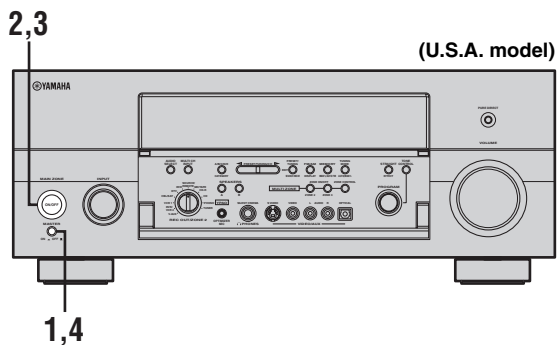

**1 Press MASTER ON/OFF on the front panel inward to the ON position to turn on the power of this unit.**

- Only this unit is turned on.
- Zone 2 and Zone 3 are set to the standby mode.



**2 Press MAIN ZONE ON/OFF on the front panel (or STANDBY on the remote control) to set this unit to the standby mode.**



or



Front panel

Remote control

- 3 Press MAIN ZONE ON/OFF, ZONE 2 ON/OFF or ZONE 3 ON/OFF on the front panel (or POWER on the remote control) to turn on this unit, Zone 2 or Zone 3.**



Front panel

or



Remote control



- When MASTER ON/OFF is pressed inward to the ON position, you can also press POWER or STANDBY on the remote control to turn on or set this unit, Zone 2 and Zone 3 to the standby mode simultaneously.
- For details about controlling Zone 2 and Zone 3 using the remote control, see page 117.

**Note**

MAIN ZONE ON/OFF, ZONE 2 ON/OFF and ZONE 3 ON/OFF on the front panel as well as POWER and STANDBY on the remote control are operational only when MASTER ON/OFF is pressed inward to the ON position.

- 4 Press MASTER ON/OFF on the front panel again to release it outward to the OFF position to turn off this unit.**

This unit, Zone 2 and Zone 3 are turned off.



## Setting the speaker impedance

Follow the procedure below to change the impedance setting for all speakers.

**CAUTION**

If you are using 6 ohm speakers, set the impedance to 6 ohms before using this unit.

- 1 Press MASTER ON/OFF on the front panel to release it outward to the OFF position to set this unit, Zone 2 and Zone 3 to the standby mode.**



- 2 Press and hold STRAIGHT (EFFECT) on the front panel and then press MASTER ON/OFF inward to the ON position to turn on the power of this unit.**

SP IMP.-8ΩMIN appears in the front panel display.

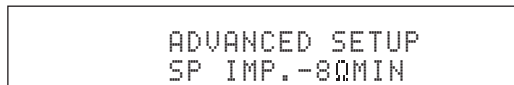

- 3 Press STRAIGHT (EFFECT) on the front panel repeatedly to select the impedance of your speakers.**



- Select 6 ohms if you are using 6 ohm speakers.
- Select 8 ohms if you are using 8 ohm speakers.

- 4 Press MASTER ON/OFF on the front panel to release it outward to the OFF position to save the new setting and set this unit, Zone 2 and Zone 3 to the standby mode.**

This unit will be set to the standby mode.



**Note**

You can also set the speaker impedance by using the SP IMP. parameter in the ADVANCED SETUP menu (see page 101).

# AUTO SETUP

## Introduction

This receiver employs YAMAHA Parametric Room Acoustic Optimizer (YPAO) technology which lets you avoid troublesome listening-based speaker setup and achieves highly accurate sound adjustments. The supplied optimizer microphone collects and analyzes the sound your speakers produce in your actual listening environment.

### Notes

- Please be advised that it is normal for loud test tones to be output during the AUTO SETUP procedure.
- If the AUTO SETUP procedure stops and error messages appear on the screen, follow the troubleshooting on page 126.

YPAO performs the following checks and makes appropriate adjustments to give you the best possible sound from your system.

### Wiring

Checks which speakers are connected and the polarity of each speaker.

### Distance

Checks the distance of each speaker from the listening position and adjusts the timing of each channel.

### Size

Checks the speaker's frequency response and sets the appropriate low frequency crossover for each channel.

### Equalizing

Adjusts frequency and levels of each channel's parametric equalizer to reduce coloration across the channels and create a cohesive sound field. This is particularly important if you use different brands or sizes of speakers for some channels or have a room with unique sonic characteristics.

YPAO equalizing calibration incorporates three parameters (frequency, level and Q factor) for each of the seven bands in its parametric equalizer to provide highly precise automatic adjustment of frequency characteristics.

### Level

Checks and adjusts the volume level of each speaker.

## Optimizer microphone setup

- 1 **Connect the supplied optimizer microphone to the OPTIMIZER MIC jack on the front panel.**

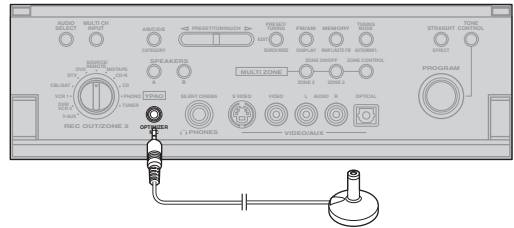

### Notes

- After you have completed the AUTO SETUP procedure, be sure to disconnect the optimizer microphone.
- The optimizer microphone is sensitive to heat.
  - Keep it away from direct sunlight.
  - Do not place it on top of this unit.

- 2 **Place the optimizer microphone on a flat level surface with the omni-directional microphone head upward, at your normal listening position.**

If possible, use a tripod (etc.) to affix the optimizer mic at the same height as your ears would be when you are seated in your listening position.

Optimizer microphone position

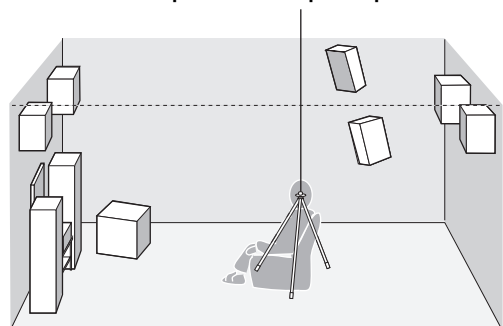

## Using AUTO SETUP

For best results, make sure the room is as quiet as possible during the AUTO SETUP procedure (YPAO). If there is too much ambient noise, the results may not be satisfactory.



- You can run AUTO SETUP using the system menu that appears in the GUI or in the front panel display. This manual uses the GUI illustrations to explain the AUTO SETUP procedure.
- If an error occurs during the AUTO SETUP procedure and an error message appears in the front panel display, see pages 126 and 127 for a complete list of error messages and proper remedies.
- If your subwoofer can adjust the output volume and the crossover frequency, set the volume to about half way (or slightly less) and set the crossover frequency to the maximum.

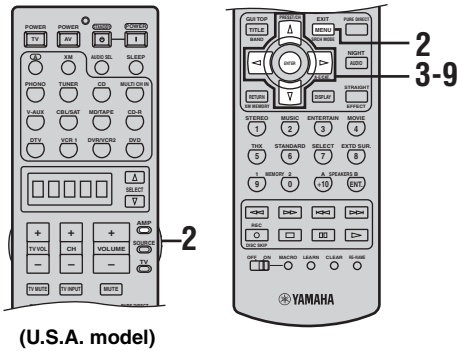
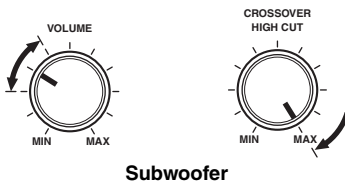

**1** Switch on this unit and video monitor.

**2** Set AMP/SOURCE/TV to AMP and then press GUI TOP on the remote control.

The top display appears.

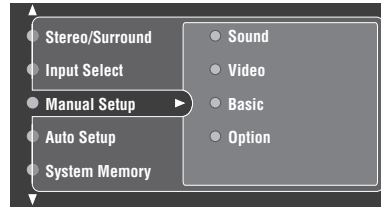
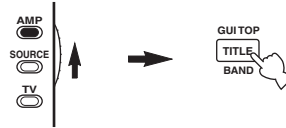

**3** Press  $\Delta$  /  $\nabla$  repeatedly to select Auto Setup and then press  $\blacktriangleright$ .

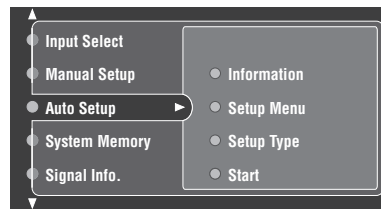
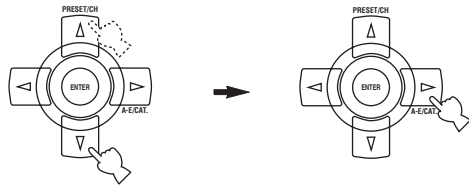

**4** Press  $\Delta$  /  $\nabla$  repeatedly to select Setup Menu and then press  $\blacktriangleright$ .



**5 Press  $\Delta$  /  $\nabla$  repeatedly to select Wiring, Distance, Size, Equalizing or Level and then press  $\triangleright$ .**

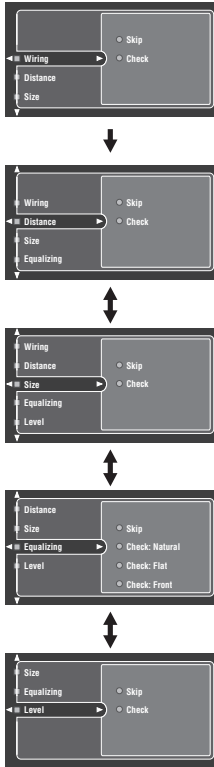

**6 For Wiring, Distance, Size or Level, select:**

- Check** To automatically check and adjust the selected item.
- Skip** To skip the selected item and perform no adjustments.



When using THX speakers, select “Skip” for Size and make sure that “Small” or “Small x2” is selected in Speaker Set (see page 90) and that “80Hz” is selected in Bass Cross Over (see page 92).

**For Equalizing, press  $\Delta$  /  $\nabla$  to select:**

- Skip** To skip the selected item and perform no adjustments.
- Check: Natural** To average out the frequency response of all speakers with higher frequencies being less emphasized. Recommended if the “Flat” setting sounds a little harsh.
- Check: Flat** To average the frequency response of all speakers. Recommended if all of your speakers are of similar quality.
- Check: Front** To adjust the frequency response of each speaker in accordance with the sound of your front speakers. Recommended if your front speakers are of much higher quality than your other speakers.

**7 Once you have selected the desired setting, press  $\triangleleft$  to move back to Setup Menu.**



**8 Press  $\nabla$  to select Setup Type and then select:**

- Auto** To automatically perform the entire AUTO SETUP procedure.
- Step** To pause for confirmation between each check in the AUTO SETUP procedure.

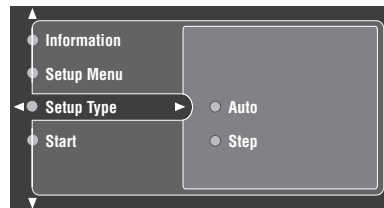

**9 Press ▾ to select Start and then press ENTER.**

Loud test tones are output from each speaker and “Measuring” appears during the AUTO SETUP procedure.

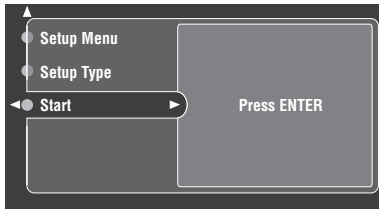

- To stop the AUTO SETUP procedure, press one of the cursor buttons (▲ / ▾ / ◀ / ▶) or ENTER. In the pause mode, press ▲ to retry the procedure, ◀ to cancel AUTO SETUP.
- If an error message appears during testing, refer to TROUBLESHOOTING on page 126, and after carrying out the remedy, retry the AUTO SETUP procedure.

**Confirming the results**

You can confirm the results of each analysis.

**If you set Setup Type to “Auto”**

The results are displayed after all items have been analyzed.

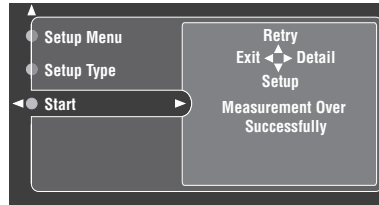

- Press ▾ and select Setup to set the measured values.
- Press ▲ and select Retry to retry the AUTO SETUP procedure.
- Press ▶ and select Detail to view information about measurement results and warning messages. For more details about warning messages, see TROUBLESHOOTING on page 126.
- Press ◀ and select Exit to exit from the AUTO SETUP procedure. If you select Exit, “Don’t Setup?” appears on the screen. To set the measured values and exit, select Yes. To cancel the settings and exit, select No.

**If you set Setup Type to “Step”**

The results are displayed individually after each analysis.

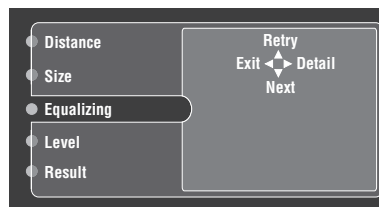

- Press ▾ and select Next to start measurement of the next menu item.
- Press ▲ and select Retry to retry the AUTO SETUP procedure.
- Press ▶ and select Detail to view information about measurement results and warning messages. For more details about warning messages, see TROUBLESHOOTING on page 126.
- Press ◀ and select Exit to exit from the AUTO SETUP procedure. If you select Exit, “Don’t Setup?” appears on the screen. To set the measured values and exit, select Yes. To cancel the settings and exit, select No.

After all menu items have been measured, “Measurement Over” appears on the screen and the results for each item are displayed.

- Press  $\nabla$  and select Setup to set the measured values.
- Press  $\Delta$  and select Retry to retry the AUTO SETUP procedure.
- Press  $\triangleright$  and select Detail to view information about measurement results and warning messages. For more details about warning messages, see TROUBLESHOOTING page 126.
- Press  $\triangleleft$  and select Exit to exit from the AUTO SETUP procedure. If you select Exit, “Don’t Setup?” appears on the screen. To set the measured values and exit, select Yes. To cancel the settings and exit, select No.



If you want to make more detailed settings, change the system parameters using the Manual Setup menu. If you want to return to the Auto Setup settings after making settings in the Manual Setup menu, navigate to the Information screen in the Auto Setup menu, press  $\Delta$  /  $\nabla$  repeatedly to select the parameter you want to adjust and then press ENTER.

### **Notes**

- If you change speakers, speaker positions, or the layout of your listening environment, perform AUTO SETUP again to recalibrate your system.
- Depending on your listening environment, SubWfr:REV may appear in the Wiring results. In this case, SWFR Phase in the Manual Setup menu (see page 92) is automatically set to Reverse. To select the desired setting, change the SWFR Phase parameter in the Manual Setup menu.
- In the Distance results, the distance displayed may be longer than the actual distance depending on the characteristics of your subwoofer. This may also be the case when using an external amplifier.
- In the Equalizing results, different values may be set for the same band to provide finer adjustments.



# PLAYBACK

## CAUTION

Extreme caution should be exercised when you play back CDs encoded in DTS. If you play back a CD encoded in DTS on a DTS-incompatible CD player, you will only hear some unwanted noise that may damage your speakers. Check whether your CD player supports CDs encoded in DTS. Also, check the sound output level of your CD player before you play back a CD encoded in DTS.

## Basic operations

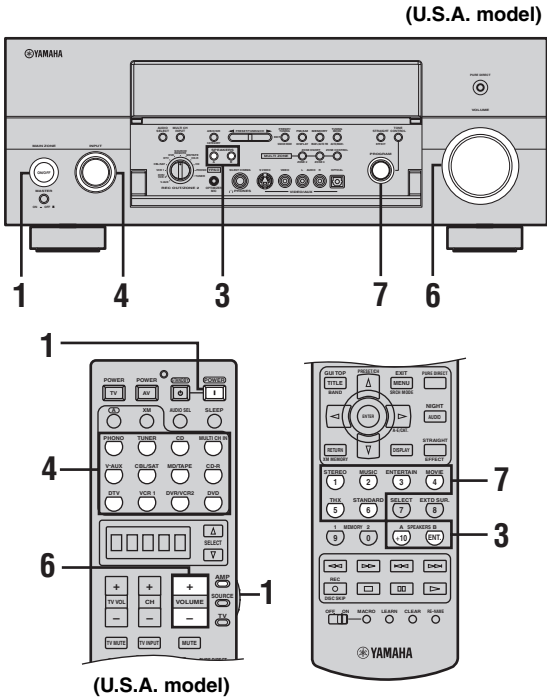

- 1 Press **MAIN ZONE ON/OFF** (or set **AMP/SOURCE/TV** to **AMP** and then press **POWER** on the remote control) to turn on the power of this unit.



or



- 2 Turn on the power of the video monitor connected to this unit.

- 3 Press **SPEAKERS A** or **B** on the front panel (or press **SPEAKERS A** or **B** on the remote control).

Each time you press **SPEAKERS A** or **B**, the respective speakers are turned on or off.

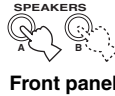

or

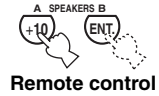

### Note

When bi-wiring, select both A and B.

- 4 Rotate the **INPUT** selector on the front panel (or press one of the input selector buttons on the remote control) to select the desired input source.

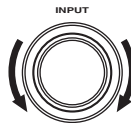

or

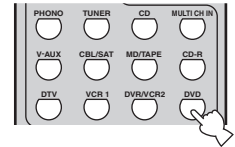

The name of the currently selected input source appears in the front panel display and on the video monitor for a few seconds.

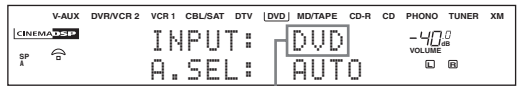

Name of the currently selected input source

- 5 Start playback or select a broadcast station on the source component.

Refer to the operation instructions for the component. See page 47 for details about tuning instructions.

- 6 Rotate VOLUME on the front panel (or press VOLUME +/- on the remote control) to adjust the volume to the desired output level.**

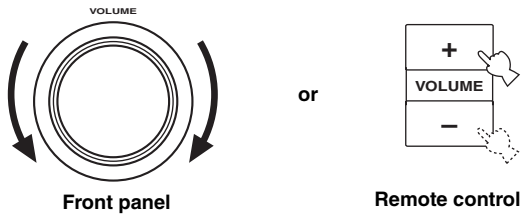

- 7 Rotate the PROGRAM selector on the front panel (or press one of the sound field program buttons on the remote control) to select the desired sound field program.**

The name of the selected sound field program appears in the front panel display and on the video monitor. See page 65 for details about sound field programs.

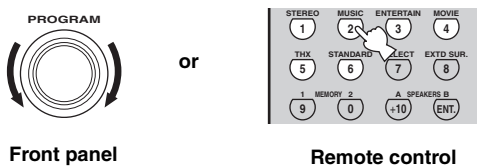

**Name of the sound field category**

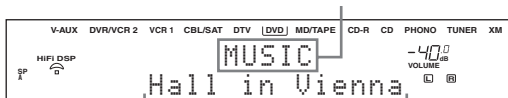

**Program name**

### Notes

- Choose a sound field program based on your listening preference, and not on the name of the program.
- When you select an input source, this unit automatically selects the last sound field program used with that source.
- Sound field programs cannot be selected when the MULTI CH INPUT is selected.

### Notes on Dialogue Normalization (Dial Norm)

Dialogue Normalization (Dial Norm) is a feature of Dolby Digital and DTS, which is used to keep the programs at the same average listening level so the user does not have to change the volume control between Dolby Digital and DTS programs. When playing back software which has been encoded in Dolby Digital and DTS, sometimes you may see a brief message in the front panel display which will read “Dial Norm X dB” (X being a numeric value). The display is showing how the program level relates with THX calibration level. If you want to play the program at calibrated theatrical levels, you may wish to adjust the volume.

DialNorm = +4dB

For example, if you see the following message: “Dial Norm + 4 dB” in the front panel display, to keep the overall output level at THX calibrated loudness, just turn down the volume control by 4dB. However, unlike a movie theater where the playback loudness is preset, you can choose your preferred volume setting for best enjoyment.

## Additional operations

### ■ Adjusting the tonal quality

Use this feature to adjust the balance of bass and treble for the front L/R and center speaker channels.

- 1 Press **TONE CONTROL** on the front panel repeatedly to select **TREBLE** or **BASS**.



- 2 Rotate the **PROGRAM** selector to adjust the high-frequency response (**TREBLE**) or the low-frequency response (**BASS**).



- 3 Press **TONE CONTROL** repeatedly to select **BYPASS** and cancel the tone control.



### Notes

- If you increase or decrease the high-frequency or the low-frequency sound to an extreme level, the tonal quality of the surround speakers may not match that of the front L/R and center speakers.
- **TONE CONTROL** is not effective when **THX** (see page 41) or **PURE DIRECT** (see page 42) is selected, or when **MULTI CH INPUT** is selected.

### ■ Muting the sound output

Use this feature to mute the sound output.

- 1 Press **MUTE** on the remote control.

The **MUTE** indicator flashes in the front panel display.



- 2 Press **MUTE** again (or press **VOLUME +/-**) to resume the sound output.

The **MUTE** indicator disappears from the display.

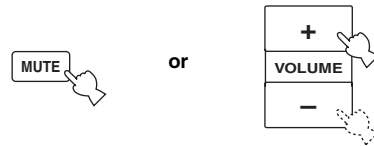

You can adjust how much the muting function reduces the sound output (see page 86).

### ■ Using **SILENT CINEMA**

Use this feature to enjoy multi-channel music or movie sound, including Dolby Digital and DTS surround, through ordinary headphones. **SILENT CINEMA** activates automatically whenever you connect headphones to the **PHONES** jack while listening to **CINEMA DSP** or **HiFi DSP** sound field programs. When activated, the **SILENT CINEMA** indicator lights up in the front panel display.

### Note

**SILENT CINEMA** is ineffective in the following cases:

- **MULTI CH INPUT** is selected as the input mode.
- **PURE DIRECT** is selected.
- A 2ch Stereo program is selected.
- This unit is in the **STRAIGHT** mode.

## ■ Selecting the MULTI CH INPUT

Press **MULTI CH INPUT** on the front panel or **MULTI CH IN** on the remote control so that **MULTI CH INPUT** appears in the front panel display and on the video monitor.

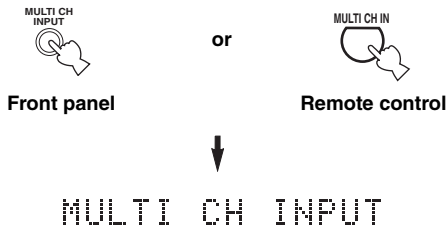

### Note

When MULTI CH INPUT is shown in the front panel display and the video monitor, no other source can be played. To select another input source with the INPUT selector on the front panel (or one of the input selector buttons on the remote control), press MULTI CH INPUT so that MULTI CH INPUT disappears from the front panel display and the video monitor.

## ■ Enjoying multi-channel software in 6.1/7.1 channel surround

If you connected one or two surround back speakers, use this feature to enjoy 6.1/7.1-channel playback for multi-channel sources using the Dolby Pro Logic IIx, Dolby Digital EX or DTS-ES decoders.

- 1 Set **AMP/SOURCE/TV** to **AMP** and then press **EXTD SUR.** on the remote control to switch between 5.1 and 6.1/7.1 channel playback.



- 2 Press **</>** repeatedly to select a decoder when the name of a decoder (**PLIIxMovie**, for example) is displayed in the front panel display.

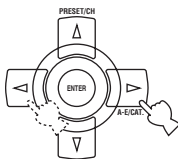

## Auto AUTO

If a signal flag can be recognized, the unit selects the optimum decoder to play back the signal in 6.1/7.1 channels. If the signal flag cannot be recognized, or no flag is present in the input signal, this unit cannot automatically play back the signal in 6.1/7.1 channels.

## Decoders

You can select a decoder from the following list depending on the format of the software you are playing.

### PLIIxMovie

To play back Dolby Digital or DTS signals in 7.1 channels using the Pro Logic IIx movie decoder.

### PLIIxMusic

To play back Dolby Digital or DTS signals in 6.1/7.1 channels using the Pro Logic IIx music decoder.

### EX/ES

To play back Dolby Digital signals in 6.1/7.1 channels using the Dolby Digital EX decoder.

DTS signals are played back in 6.1/7.1 channels using the DTS-ES decoder.

### EX

To play back Dolby Digital or DTS signals in 6.1/7.1 channels using the Dolby Digital EX decoder.

### OFF

To play back Dolby Digital or DTS signals in 5.1 channels.



When Surround Back is set to Large x1 or Small x1 (see page 91), the surround back channel will output from the left SURROUND BACK speaker terminals.

### Notes

- Some 6.1-channel compatible discs do not have a signal flag which cannot be automatically detected. When you play these kinds of discs in 6.1-channel, select decoders (PLIIxMovie, PLIIxMusic, EX/ES or EX) manually.
- 6.1/7.1-channel playback is not possible even if EXTD SUR. is pressed in the following cases:
  - When Surround (see page 91) or Surround Back (see page 91) is set to None.
  - When the source connected to the MULTI CH INPUT jacks are being played.
  - When the source being played does not contain surround L/R channel signals.
  - When a Dolby Digital KARAOKE source is being played.
  - When 2ch Stereo, 7ch Stereo or PURE DIRECT is selected.
- When the power of this unit is turned off, the input mode will be reset to AUTO.
- The Pro Logic IIx decoder is not available when Surround Back is set to None (see page 91).
- PLIIxMovie cannot be selected when Surround Back is set to Large x1 or Small x1 (see page 91).

## ■ Enjoying 2-channel software in surround

Signals input from 2-channel sources can also be played back in multiple channels.

### 1 Set AMP/SOURCE/TV to AMP and then press STANDARD on the remote control to switch between the Surround and Enhanced programs.

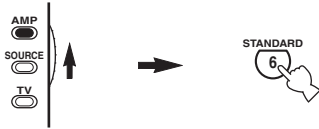

You can also press MOVIE or THX on the remote control to select the MOVIE THEATER or THX programs.

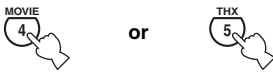

### 2 Press SELECT on the remote control to select a decoder.



You can select a decoder from the following list depending on the type of software you are playing and your personal preference.

#### Decoder types for the Surround program

<PRO LOGIC>

Dolby Pro Logic processing for any sources.

<PLIIx Movie>

Dolby Pro Logic IIx processing for movie software.

<PLIIx Music>

Dolby Pro Logic IIx processing for music software.

<PLIIx Game>

Dolby Pro Logic IIx processing for game software.

<Neo:6 Cinema>

DTS processing for movie software.

<Neo:6 Music>

DTS processing for music software.

#### Decoder types for the Enhanced, MOVIE THEATER or THX program

<PRO LOGIC>

Dolby Pro Logic processing for any sources.

<PLIIx Movie>

Dolby Pro Logic IIx processing for movie software.

<Neo:6 Cinema>

DTS processing for movie software.



- You can also select a decoder by using Decoder Mode in Input Select (see page 82).
- You can also select a decoder by pressing <◀/▶> on the remote control when the decoder type is displayed in the short message display.

#### Note

The Pro Logic IIx decoder automatically changes to the Pro Logic II decoder when Surround Back is set to None (see page 91).

## ■ Using PURE DIRECT

PURE DIRECT bypasses the decoders and DSP processors of this unit as well as shuts down the video circuitry, allowing you to enjoy the highest possible sound fidelity from analog and PCM sources.

### Notes

- To avoid unexpected noise, do not play DTS-encoded CDs in the PURE DIRECT mode.
- When a multi-channel signal (Dolby Digital or DTS) is input, this unit automatically switches to the corresponding analog input. When DTS is selected as an input mode, no sound will be heard.
- No sound will be output from the subwoofer.
- TONE CONTROL on the front panel and the GUI menu settings are ineffective in the PURE DIRECT mode.
- The following operations are not possible in the PURE DIRECT mode:
  - switching the sound field program
  - displaying the short message
  - adjusting GUI menu parameters
  - all video functions including video conversions
  - HDMI digital video up-conversion of analog video signals
  - HDMI digital output
- PURE DIRECT is automatically canceled whenever this unit is set to the standby mode.

## 1 Press PURE DIRECT on the front panel or on the remote control to activate pure direct.

The indicator around the button on the front panel lights up and the front panel display automatically goes out.

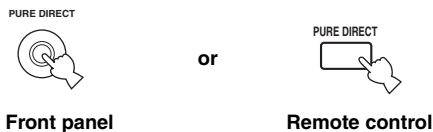

### Note

The front panel display switches on momentarily when an operation is performed.

## 2 Press PURE DIRECT on the front panel or on the remote control again to deactivate pure direct.

The indicator around the button on the front panel goes out and the previous settings are restored.

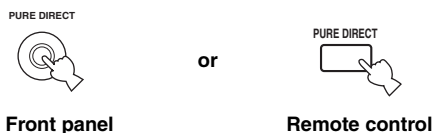

## ■ Using the night listening modes

The night listening modes are designed to improve listenability at lower volume levels or at night. Choose either NIGHT:CINEMA or NIGHT:MUSIC depending on the type of source you are playing.

### Notes

- You cannot use the night listening modes if PURE DIRECT or MULTI CH INPUT are being used or if headphones are connected even though the NIGHT indicator lights up when PURE DIRECT is selected.
- The night listening modes may vary in effectiveness depending on the input source and the surround sound settings being used.

## 1 Set AMP/SOURCE/TV to AMP and then press NIGHT on the remote control repeatedly to select NIGHT:CINEMA or NIGHT:MUSIC.

When a night listening mode is selected, the NIGHT indicator lights up in the front panel display.

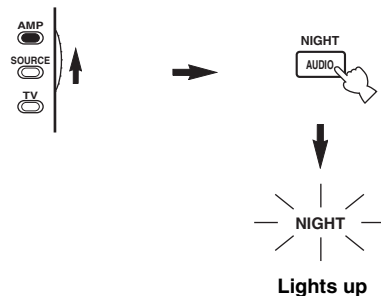

- Select NIGHT:CINEMA when watching films to reduce the dynamic range of film soundtracks and make dialog easier to hear at lower volume levels.
- Select NIGHT:MUSIC when listening to music sources to preserve ease-of-listening for all sounds.
- Select NIGHT:OFF if you do not want to use this function.

## 2 Press </> to adjust the effect level of compression while NIGHT:CINEMA or NIGHT:MUSIC is displayed.

Choices: MIN, MID, MAX

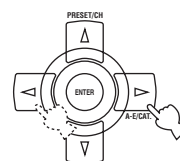

Remote control

Effect.Lvl: MID

- Select MIN for minimum compression.
- Select MID for standard compression.
- Select MAX for maximum compression.



NIGHT:CINEMA and NIGHT:MUSIC settings are stored independently.

## ■ Using the sleep timer

Use this feature to automatically set this unit in the standby mode after a certain amount of time. The sleep timer is useful when you are going to sleep while this unit is playing or recording a source. The sleep timer also automatically turns off any external components connected to the AC OUTLETS.

**1 Select an input source and start playback on the source component.**

**2 Press SLEEP on the remote control repeatedly to set the amount of time.**



Each time you press SLEEP, the front panel display changes as shown below.



The SLEEP indicator flashes while switching the amount of time for the sleep timer.

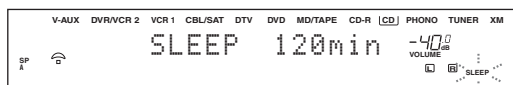

The SLEEP indicator lights up in the front panel display, and the display returns to the selected sound field program.

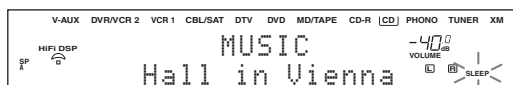

**3 Press SLEEP repeatedly so that SLEEP OFF appears in the front panel display.**

The SLEEP indicator turns off and then SLEEP OFF appears in the front panel display. After a few seconds, the display returns to the selected sound field program.



The sleep timer setting can also be canceled by pressing STANDBY on the remote control (or MAIN ZONE ON/OFF on the front panel) to set this unit, Zone 2 and Zone 3 to the standby mode.

## ■ Downmixing to 2 channels

You can enjoy 2-channel stereo playback from multi-channel sources.

**Rotate the PROGRAM selector (or set AMP/SOURCE/TV to AMP and then press STEREO on the remote control) to select 2ch Stereo.**

2ch Stereo appears in the front panel display.



Front panel

or

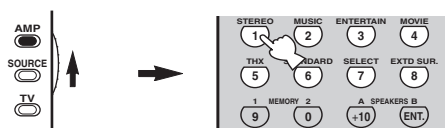

Remote control

2ch Stereo

### Note

You can use a subwoofer with this program when SWFR or Both is selected in Bass Out (see page 92).

## ■ Listening to unprocessed input signals

When the unit is in the STRAIGHT mode, 2-channel stereo sources are output only from the front L/R speakers. Multi-channel sources are decoded straightly into the appropriate channels without any additional effect processing.

**1 Press STRAIGHT (EFFECT) on the front panel or on the remote control to select STRAIGHT.**

STRAIGHT appears in the front panel display.



Front panel

or



Remote control

STRAIGHT

- 2 Press STRAIGHT (EFFECT) on the front panel or on the remote control again to turn the sound effect back on.**  
STRAIGHT disappears from the front panel display.

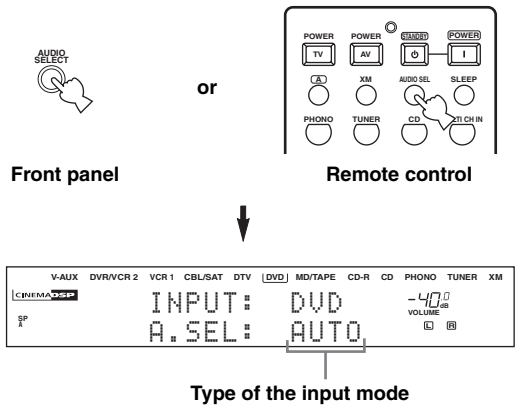
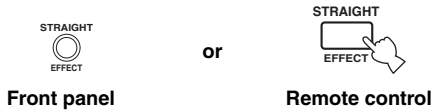

## Virtual CINEMA DSP

Virtual CINEMA DSP allows you to enjoy the CINEMA DSP programs without surround speakers. It creates virtual speakers to reproduce a natural sound field. If you set Surround to None (see page 91), Virtual CINEMA DSP activates automatically whenever you select a CINEMA DSP sound field program.

### Note

Virtual CINEMA DSP is ineffective even if Surround is set to None (see page 91) in the following cases:

- If MULTI CH INPUT is selected as the input source.
- If headphones are connected to the PHONES jack.

## Playing video sources in the background

You can combine images from a video source with sound from an audio source. For example, you can listen to classical music while enjoying beautiful scenery from the video source on the video monitor.

**Press one of the input selector buttons on the remote control to select a video source and then select an audio source.**

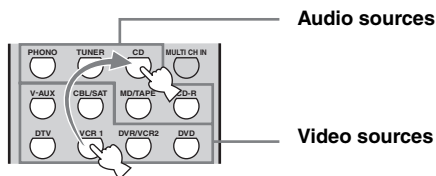

### Note

If you want to enjoy an audio source connected to the MULTI CH INPUT jacks together with a video source, first select the video source and then press MULTI CH INPUT on the front panel or on the remote control.

## Selecting audio input modes

This unit comes with a variety of input jacks. You can select the type of input signal you want to use.

**Press AUDIO SELECT on the front panel or AUDIO SEL on the remote control to select an input mode.**

## AUTO

Automatically selects input signals in the following order:

- 1) HDMI
- 2) Digital signals
- 3) Analog signals

## HDMI

Selects only HDMI signals. If no HDMI signals are input, no sound is output.

## COAX/OPT

Selects digital signals input at the OPTICAL or COAXIAL jacks. Use if HDMI signals are also being input.

## ANALOG

Selects only analog signals. If no analog signals are input, no sound is output.



- We recommend using AUTO in most cases.
- You can designate the default input mode to be selected when the power of this unit is turned on (see page 30).

### Notes

- This feature is not available if no digital input jacks (OPTICAL, COAXIAL and HDMI) are assigned. In addition, HDMI is not available as an input mode if HDMI IN 1 and HDMI IN 2 jacks are not assigned. Use I/O Assignment in Input Select to reassign the respective input jacks (see page 81).
- If the digital output data of the player has been processed in any way, you may not be able to perform DTS decoding even if you make a digital connection between this unit and the player.
- If this unit detects a Dolby Digital or DTS signal, the decoder automatically switches to the appropriate sound field program.
- The input jacks not assigned are not available as input modes.
- The parameter setting for Decoder Mode (see page 82) takes priority over the audio input mode selected using AUDIO SELECT on the front panel or AUDIO SEL on the remote control. As a result, if Decoder Mode is set to a setting other than Auto and ANALOG is selected as the audio input mode, there will be no audio output. To resume audio output, set Decoder Mode to Auto or select a setting other than ANALOG as the audio input mode.



## ■ Displaying information about the input source

You can display the type, format and sampling frequency of the current input signal.

### 1 Set AMP/SOURCE/TV to AMP and then press GUI TOP on the remote control.

The top display appears.

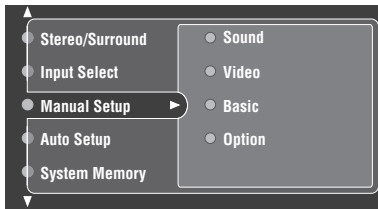

### 2 Press $\nabla$ repeatedly to select Signal Info. and then press $\triangleright$ .

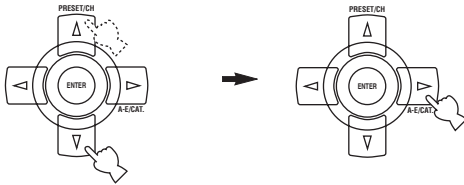

### 3 Press $\triangleleft/\triangleright$ repeatedly to select Audio Info. or Video Info..

The following information appears.

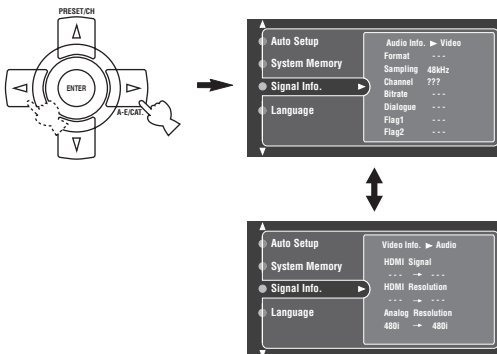

## Audio Info. (Audio information)

### Format

Signal format display. When the unit cannot detect a digital signal, it automatically switches to analog input.

### Sampling

Sampling frequency. When the unit is unable to detect the sampling frequency “?” appears.

### Channel

Number of source channels in the input signal. For example, a multi-channel soundtrack with 3 front channels, 2 surround channels and LFE, is displayed as “3/2/0.1”.

### Bitrate

Bit rate. When the unit is unable to detect the bit rate “---” appears.

### Dialogue

Dialogue normalization information for Dolby Digital and DTS signals.

### Flag1/Flag2

Flag data encoded in Dolby Digital, DTS and PCM signals that cue this unit to automatically switch decoders.

## Video Info. (Video information)

### HDMI Signal

Type of the HDMI signals input or output at the HDMI IN/OUT jacks of this unit.

### HDMI Resolution

Resolution of the HDMI signals input or output at the HDMI IN/OUT jacks of this unit.

### Analog Resolution

Resolution of the analog signals input or output at the video component jacks of this unit.

### 4 Press EXIT on the remote control to exit.



# RECORDING

Recording adjustments and other operations are performed from the recording components. Refer to the operation instructions for those components.

(U.S.A. model)

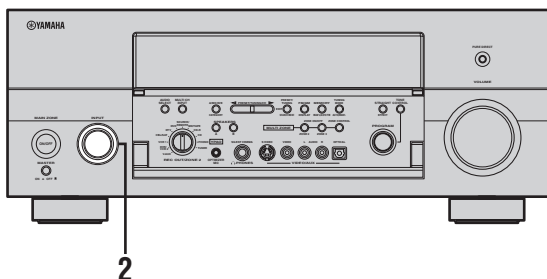

**1 Turn on the power of this unit and all connected components.**

See page 30 for details.

**2 Rotate the INPUT selector on the front panel (or set AMP/SOURCE/TV to SOURCE and then press one of the input selector buttons) to select the input source you want to record from.**

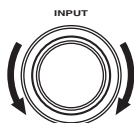

Front panel

or

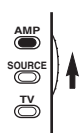

Remote control

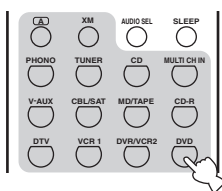

**3 Start playback (or select a broadcast station) on the source component.**

**4 Start recording on the recording component.**



Do a test recording before you start an actual recording.

## Notes

- The source you record and the source sent to Zone 2 can be selected separately.
- When this unit is in the standby mode, you cannot record from other components connected to this unit.
- The settings for Tone Control (see page 39), VOLUME, Speaker Level (see page 93) and programs do not affect recorded material.
- A source connected to the MULTI CH INPUT jacks of this unit cannot be recorded.
- S-video and composite video signals pass independently through the video circuits of this unit. Therefore, when recording or dubbing video signals, if your video source component is connected to provide only an S-video or only a composite video signal, you can record only an S-video or only a composite video signal to your VCR.
- Digital signals input at the DIGITAL INPUT jacks are not output at the analog AUDIO OUT L/R jacks for recording. Likewise, analog signals input at the AUDIO IN L/R jacks are not output at the DIGITAL OUTPUT jack. Therefore, if your source component is connected to provide only digital or analog signals, you can only record digital or analog signals.
- A given input source is not output on the same OUT (REC) channel. For example, the signal input at VCR 1 IN is not output at VCR 1 OUT.
- Check the copyright laws in your country to record from records, CDs, radio, etc. Recording of copyrighted material may infringe copyright laws.
- Some HDMI audio signals input at the HDMI IN 1 or HDMI IN 2 jack of this unit may not be output at the DIGITAL AUDIO (OPTICAL) jacks depending on the type of those HDMI audio signals.

If you play back a video source that uses scrambled or encoded signals to prevent it from being dubbed, the picture itself may be disturbed due to those signals.

## Notes on the DTS software

The DTS signal is a digital bitstream. Attempting to digitally record the DTS bitstream will result in noise being recorded. Therefore, if you want to use this unit to record sources that have DTS signals recorded on them, the following considerations and adjustments need to be made.

For DVDs and CDs encoded in DTS, when your player is compatible with the DTS format, follow its operation instructions to make a setting so that the analog signal will be output from the player.

# FM/AM TUNING

## Automatic tuning

Automatic tuning is effective when station signals are strong and there is no interference.

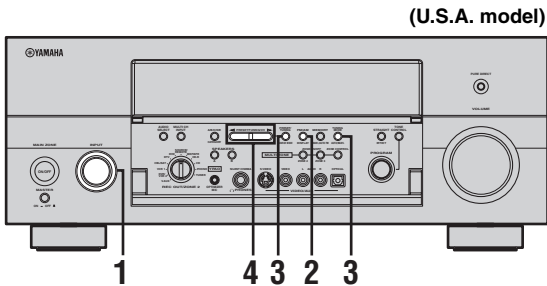

- 1 Rotate the INPUT selector on the front panel (or set AMP/SOURCE/TV to SOURCE and then press TUNER on the remote control) to select TUNER as the input source.

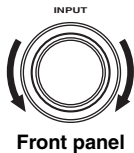

or

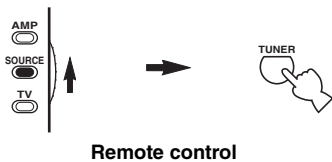

- 2 Press FM/AM on the front panel (or BAND on the remote control) to select the reception band.

FM or AM appears in the front panel display.

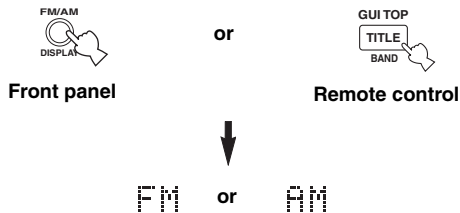

- 3 Press TUNING MODE (AUTO/MAN'L) repeatedly so that the AUTO indicator lights up in the front panel display.



If a colon (:) appears in the front panel display, this unit is in PRESET mode and tuning is not possible. Press PRESET/TUNING (EDIT) to turn it off.

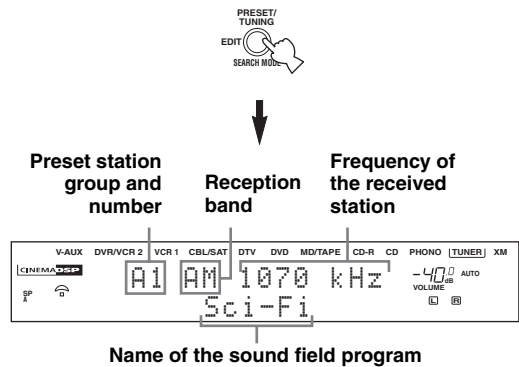

- 4 Press PRESET/TUNING/CH </> once to begin automatic tuning.

Press > to tune into a higher frequency.  
Press < to tune into a lower frequency.

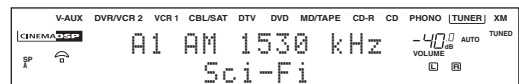
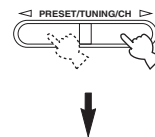

When the unit is tuned into a station, the TUNED indicator lights up and the frequency of the received station is shown in the front panel display.

## Manual tuning

Manual tuning is effective when stations signals are weak. Manually tuning into an FM station will automatically change the reception mode to monaural reception to increase the signal quality.

- 1 Repeat steps 1 and 2 in “Automatic tuning” to select TUNER and the reception band.
- 2 Press TUNING MODE (AUTO/MAN'L) repeatedly so that the AUTO indicator disappears from the front panel display.



If a colon (:) appears in the front panel display, this unit is in the PRESET mode and tuning is not possible. Press PRESET/TUNING (EDIT) to turn it off.

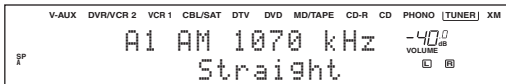

- 3 Press PRESET/TUNING/CH ◀/▶ to manually tune into the desired station.

Press ▶ to tune into a higher frequency.  
Press ◀ to tune into a lower frequency.



Press and hold the button to continue searching.

## Automatic preset tuning

You can use the automatic preset tuning feature to store FM stations. This function enables this unit to automatically tune into FM stations with strong signals and store up to 40 (8 stations in each of the 5 groups, A1 to E8) of those stations in order. You can then recall any preset station easily by selecting the preset station number.

### Note

You must first set AMP/SOURCE/TV to SOURCE and then press TUNER on the remote control to select TUNER as the input source.

(U.S.A. model)

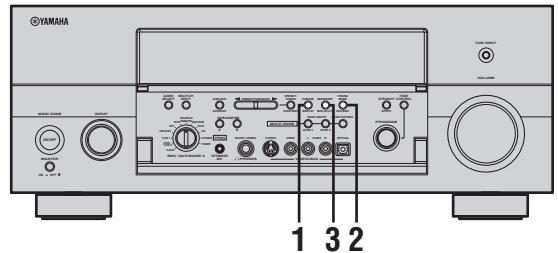

- 1 Press FM/AM on the front panel (or BAND on the remote control) to select FM as the reception band.



or



Front panel

Remote control



FM

- 2 Press TUNING MODE (AUTO/MAN'L) so that the AUTO indicator lights up in the front panel display.



Lights up

### 3 Press and hold MEMORY (MAN'L/AUTO FM) on the front panel for more than 3 seconds.

The preset group and number as well as the MEMORY and AUTO indicators flash. After approximately 5 seconds, automatic presetting starts from the currently selected frequency and proceeds toward the higher frequencies.

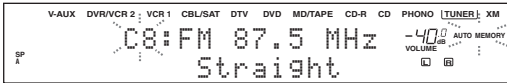

When automatic preset tuning is completed, the front panel display shows the frequency of the last preset station.

#### Notes

- Any station data stored under a preset station number is cleared when you store a new station under the same preset station number.
- If the preset number of the received stations does not reach 40 (E8), automatic preset tuning automatically stops after programming all available stations.
- Only FM stations with sufficient signal strength are stored automatically by automatic preset tuning. If the station you want to store is weak in signal strength, tune into it manually and store it by following the procedure in “Manual preset tuning”.

### ■ Customized automatic preset tuning

You can specify a preset station group and a preset station number from which this unit stores the FM stations received by automatic preset tuning.

#### 1 Repeat steps 1 to 3 in “Automatic preset tuning”.

#### 2 Press A/B/C/D/E and then PRESET/TUNING/CH </> on the front panel to select the preset station group and the preset station number where the first received station will be stored.

For example, if you select C5, the first received station is automatically programmed to C5 and the next received stations are sequentially programmed to C6, C7, etc.

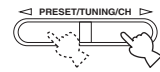

#### Note

Automatic preset tuning stops when the received stations have all been stored up to E8.

#### Memory back-up

The memory back-up circuit prevents the stored data from being lost. However, the stored data will be lost in case the power cord is disconnected from the AC wall outlet for more than one week.

## Manual preset tuning

You can also store up to 40 FM or AM stations (8 stations in each of the 5 groups, A1 to E8) manually.

### Note

You must first set AMP/SOURCE/TV to SOURCE and then press TUNER on the remote control to select TUNER as the input source.

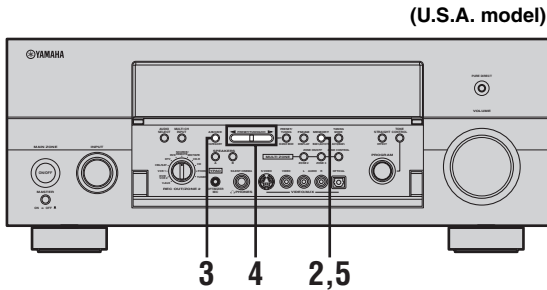

- 1 Repeat steps in “Automatic tuning” or “Manual tuning” to tune into a station automatically or manually.

See page 47 for tuning instructions.

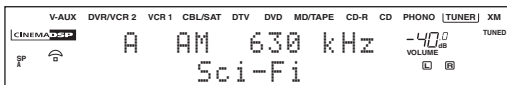

When this unit is tuned into a station, the front panel display shows the frequency of the received station.

- 2 Press MEMORY (MAN'L/AUTO FM) on the front panel.

The MEMORY indicator flashes for about 5 seconds.



- 3 Press A/B/C/D/E on the front panel repeatedly to select a preset station group (A to E) while the MEMORY indicator is flashing. The group letter appears. Check that the colon (:) appears in the front panel display.



Preset station group

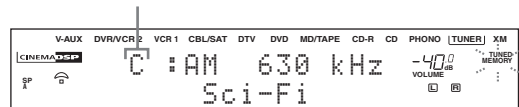

- 4 Press PRESET/TUNING/CH </> on the front panel to select a preset station number (1 to 8) while the MEMORY indicator is flashing.

Press PRESET/TUNING/CH > on the front panel to select a higher preset station number.

Press PRESET/TUNING/CH < on the front panel to select a lower preset station number.

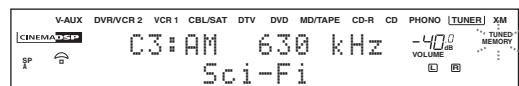

**5 Press MEMORY (MAN'L/AUTO FM) on the front panel while the MEMORY indicator is flashing.**

The station band and frequency appear in the front panel display with the preset group and number you have selected.



**6 Repeat steps 1 to 5 to store other stations.**

**Notes**

- Any stored station data existing under a preset number is cleared when you store a new station under that preset number.
- The reception mode (stereo or monaural) is stored along with the station frequency.

**Selecting preset stations**

You can tune into any desired station simply by selecting the preset station number under which it was stored.

**Note**

Prior to selecting a preset station, you should preset stations first. For details, see “Automatic preset tuning” on page 48 or “Manual preset tuning” on page 50.

(U.S.A. model)

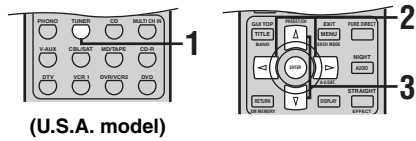
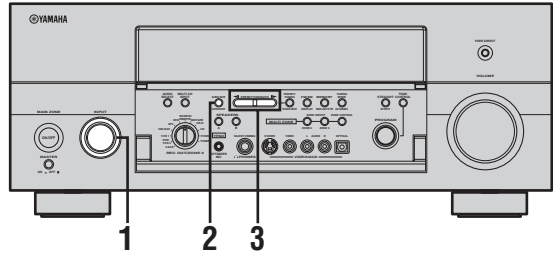

(U.S.A. model)

**1 Rotate the INPUT selector on the front panel (or set AMP/SOURCE/TV to SOURCE and then press TUNER on the remote control) to select TUNER as the input source.**

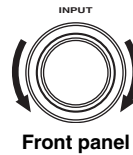

Front panel

or



Remote control

- 2 Press A/B/C/D/E (or </> on the remote control) to select the preset station group.**

The preset group letter appears in the front panel display and changes each time you press the button.

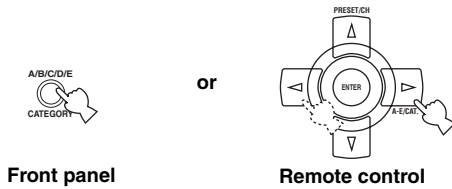

- 3 Press PRESET/TUNING/CH </> (or PRESET  $\Delta$  /  $\nabla$  on the remote control) to select a preset station number (1 through 8).**

The preset group and number appear in the front panel display along with the station band, frequency and the TUNED indicator lights up.

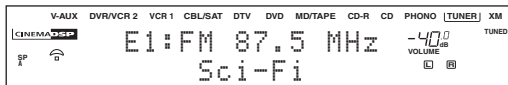
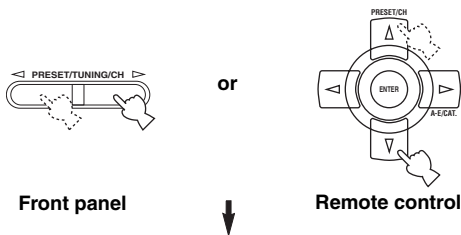

## Exchanging preset stations

You can exchange the assignment of two preset stations with each other. The example below describes the procedure for exchanging preset station E1 with A5.

(U.S.A. model)

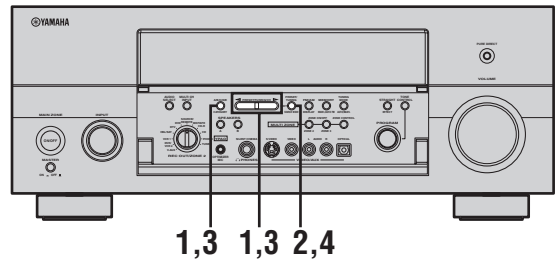

- 1 Select preset station E1 by using A/B/C/D/E and PRESET/TUNING/CH </>.**  
See "Selecting preset stations".



- 2 Press and hold PRESET/TUNING (EDIT) for more than 3 seconds.**

E1 and the MEMORY indicator flash in the front panel display.

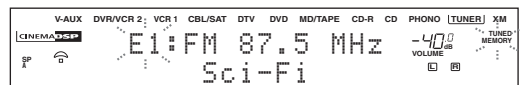

- 3 Select preset station A5 by using A/B/C/D/E and PRESET/TUNING/CH </>.**

A5 and the MEMORY indicator flash in the front panel display.

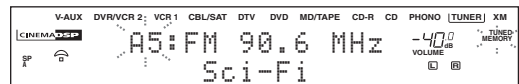

- 4 Press PRESET/TUNING (EDIT) again.**

The stations stored at the two preset assignments are exchanged.

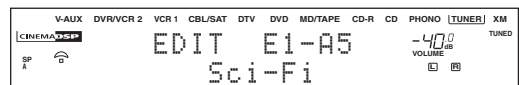



# XM<sup>®</sup> SATELLITE RADIO TUNING

## What is XM Satellite Radio?

XM Satellite Radio is the satellite radio service with millions of listeners across the United States broadcasting live daily. The XM Satellite Radio channel lineup includes more than 150 digital channels of choice from coast to coast: 67 commercial-free music channels, featuring hip hop to opera, classical to country, bluegrass to blues; 33 channels of premier sports, talk, comedy, children's and entertainment programming; and more than 20 channels of the traffic and weather information for major metropolitan areas nationwide.

Because XM Satellite Radio is a subscription service, you will need to set up an account and activate service with XM using your XM Satellite Radio ID number. To check your ID number, follow "Activating XM Satellite Radio" on page 55. For further information on XM Satellite Radio services, visit the XM Satellite Radio website at "<http://www.xmradio.com>".

### ■ Information from XM Satellite Radio Inc.

Hardware and required basic monthly subscription sold separately. Premium Channel available at additional monthly cost. Installation costs and other fees and taxes, including a one-time activation fee may apply. Subscription fee is consumer only. All fees and programming subject to change. Channels with frequent explicit language are indicated with an XL. Channel blocking is available for XM radio receivers by calling 1-800-XMRADIO. Subscriptions subject to Customer Agreement available at [xmradio.com](http://xmradio.com). Only available in the 48 continuous United States. © 2005 XM Satellite Radio Inc. All rights reserved. All other trademarks are the property of their respective owners.

## XM Satellite Radio connections

Connect the XM Connect-and-Play digital antenna accessory (sold separately) to the XM jack on the rear of this unit. (For details, refer to the operating instructions provided with the XM Connect-and-Play digital antenna accessory).

(U.S.A. model)

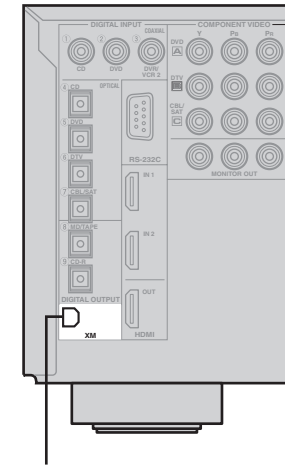

XM jack

### Notes

- For information on obtaining the XM Connect-and-Play digital antenna accessory, visit the XM Satellite Radio website at "<http://www.xmradio.com>" or consult your local retailer that sells XM Ready products.
- To ensure the optimal reception of the XM Satellite Radio signals, the XM Connect-and-Play digital antenna accessory must be placed at or near a southerly facing window with no obstacles in the path to the sky. You can mount it indoors or outdoors.

## XM Satellite Radio controls and functions

This section describes the functions of each control used for XM Satellite Radio tuning.

### Note

The following controls are only available when XM is selected as the input source. Rotate the INPUT selector on the front panel (or set AMP/SOURCE/TV to SOURCE and then press XM on the remote control) to select XM as the input source.

### ■ Front panel functions

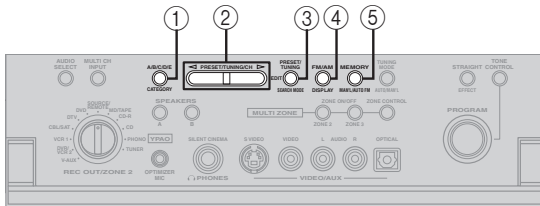

(U.S.A. model)

#### ① CATEGORY

##### (All Channel Search mode)

Changes the channel category to next one (while staying in the All Channel Search mode).

##### (Category Search mode)

Changes the channel category to next one.

##### (Preset Search mode)

Switches between five preset groups (A to E).

#### ② PRESET/TUNING/CH ◀ / ▶

##### (All Channel Search mode)

Searches a radio channel within all channels. Press and hold for quick search.

##### (Category Search mode)

Searches a radio channel within the selected category. Press and hold for quick search.

##### (Preset Search mode)

Changes the preset channel number (1 to 8).

#### ③ SEARCH MODE

Switches between the All Channel Search, Category Search, and Preset Search modes (see page 57).

#### ④ DISPLAY

Switches XM information such as channel number/name, category or artist name/song title displayed in the front panel display (see page 62).

#### ⑤ MEMORY

Switches the unit to the preset memory mode.

### ■ Remote control functions

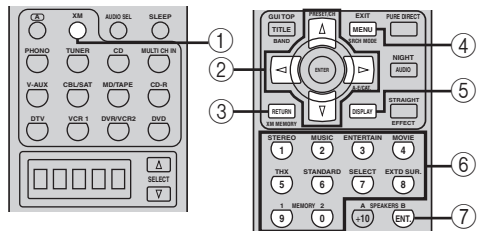

(U.S.A. model)

#### ① XM

Selects XM as the input source.

#### ② Cursor buttons ▲ / ▼ / ◀ / ▶

##### (All Channel Search mode)

Press A-E/CAT. ◀ / ▶ to change the channel category. Press PRESET/CH ▲ / ▼ to search a radio channel within all channels. Press and hold for quick search.

##### (Category Search mode)

Press A-E/CAT. ◀ / ▶ to change the channel category. Press PRESET/CH ▲ / ▼ to search a radio channel within the selected category. Press and hold for quick search.

##### (Preset Search mode)

Press A-E/CAT. ◀ / ▶ to change the preset group (A to E).

Press PRESET/CH ▲ / ▼ to change the preset number (1 to 8).

#### ③ XM MEMORY

Switches the unit to the preset memory mode.

#### ④ SRCH MODE

Switches between the All Channel Search, Category Search, and Preset Search modes (see page 57.).

#### ⑤ DISPLAY

Switches XM information such as channel number/name, category or artist name/song title displayed in the front panel display (see page 62).

#### ⑥ Numeric buttons

##### (All Channel Search or Category Search mode)

Use 1 to 9 and 0 to enter a channel number directly.

##### (Preset Search mode)

Use 1 to 8 to enter a preset channel number directly.

#### ⑦ ENT.

Confirms an entered channel number during the Direct Number Access mode (see page 59).

■ Zone 2/Zone 3 remote control functions

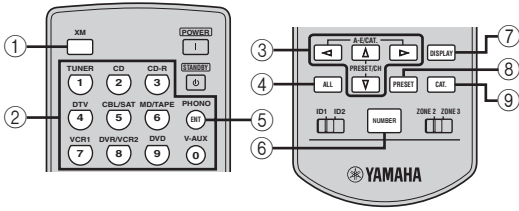

- ① **XM**  
Selects XM as the input source.
- ② **Input selector/numeric buttons (All Channel Search or Category Search mode)**  
Use 1 to 9 and 0 to enter a channel number directly.  
**(Preset Search mode)**  
Use 1 to 8 to enter a preset channel number directly.

**Note**

To enter numbers, you must press and hold SHIFT before you press any of these buttons.

- ③ **Cursor buttons  $\Delta$  /  $\nabla$  /  $\triangleleft$  /  $\triangleright$  (All Channel Search mode)**  
Press  $\triangleleft$  /  $\triangleright$  to change the channel category.  
Press  $\Delta$  /  $\nabla$  to search a radio channel within all channels.  
Press and hold for quick search.  
**(Category Search mode)**  
Press  $\triangleleft$  /  $\triangleright$  to change the channel category.  
Press  $\Delta$  /  $\nabla$  to search a radio channel within the selected category. Press and hold for quick search.  
**(Preset Search mode)**  
Press  $\triangleleft$  /  $\triangleright$  to change the preset group (A to E).  
Press  $\Delta$  /  $\nabla$  to change the preset number (1 to 8).

- ④ **ALL**  
Selects the All Channel Search mode (see page 57).

- ⑤ **ENT**  
Confirms an entered channel number during the Direct Number Access mode (see page 59).

- ⑥ **NUMBER**  
Press and hold before you press the input selector/numeric buttons to switch the function to entering numbers.

- ⑦ **DISPLAY**  
Switches XM information such as channel number/name, category or artist name/song title displayed in the front panel display (see page 62).

- ⑧ **PRESET**  
Selects the Preset Search mode (see page 58).

- ⑨ **CAT.**  
Selects the Category Search mode (see page 58)

**Activating XM Satellite Radio**

To sign up for an account with the XM Satellite Radio service, an XM Satellite Radio ID number is required. Follow the procedure below to check your ID number, and then access the website at “<http://activate.xmradio.com/>” or call “1-800-XM-RADIO (1-800-967-2346)” with a major credit card for signing up.

(U.S.A. model)

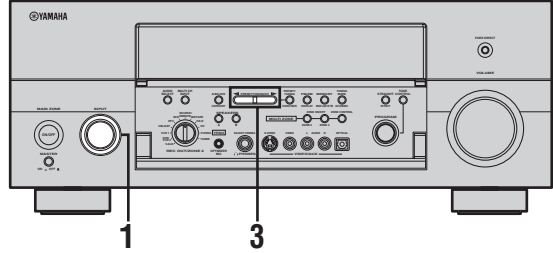

- 1 **Rotate the INPUT selector (or set AMP/SOURCE/TV to SOURCE and then press XM on the remote control) to select XM as the input source.**

The XM indicator lights up.

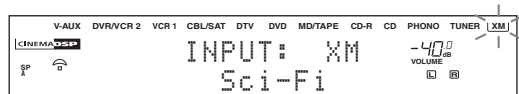
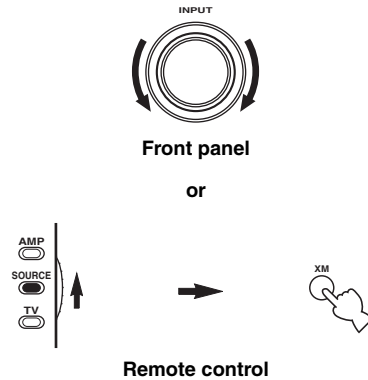

BASIC OPERATION

**2 Check the XM Satellite Radio reception level and adjust the orientation of the XM Satellite Radio antenna for a better percentage of the reception level.**



You can display the XM Satellite Radio reception level by using the Antenna Level parameter in Input Select (see page 80).

**Notes**

- If CHECK ANTENNA appears in the front panel display, the XM Connect-and-Play digital antenna accessory may not be connected to the XM jack on the rear of this unit properly. See “XM Satellite Radio connections” on page 53 and check the connection.
- The Antenna Level parameter cannot be adjusted by using the remote control.

**3 Press PRESET/TUNING/CH ◀ / ▶ (or PRESET/CH ▲ / ▼ on the remote control) to select channel 0.**

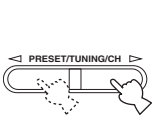

Front panel

or

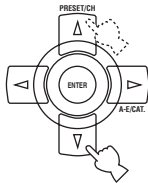

Remote control

**Note**

You cannot select channel 0 if the All Channel Search mode (see page 57) is not selected.

**4 Check the XM Satellite Radio ID number displayed in the front panel display and write it down.**

ID: \_\_\_\_\_

**Selecting the XM Satellite Radio mode**

(U.S.A. model)

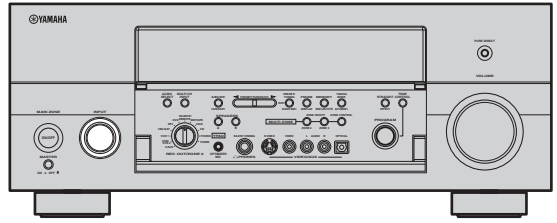

**Rotate the INPUT selector (or press XM on the remote control) to select XM as the input source.**

Information (such as channel number/name, category, or artist name/song title) for the channel currently selected appears in the front panel display and the XM indicator lights up.

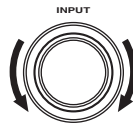

Front panel

or



Remote control



- Selecting the XM band automatically recalls the channel previously selected.
- You can change the kind of channel information by pressing DISPLAY repeatedly (see page 62).

**Note**

The XM Satellite Radio signals cannot be output at the AUDIO OUT (REC) jacks.

## Using XM Satellite Radio search modes

You can search for the channel you want to listen to using one of three search modes. You can also enter the number directly to select the desired channel. For details, see “Direct Number Access mode” on page 59.

### ■ All Channel Search mode

(U.S.A. model)

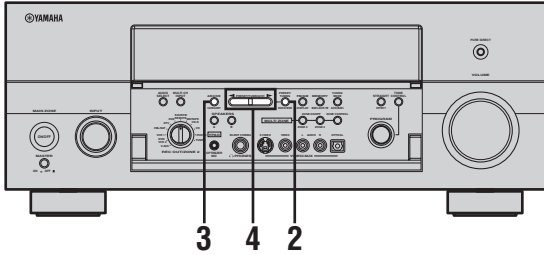

**1** Carry out “Selecting the XM Satellite Radio mode” on page 56.

**2** Press SEARCH MODE (or SRCH MODE on the remote control) repeatedly to select ALL CH SEARCH.

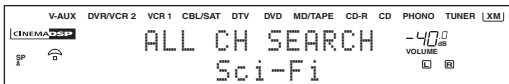
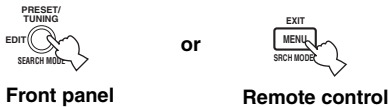

**3** To change the channel category, press CATEGORY (or A-E/CAT. </> on the remote control) repeatedly.



Front panel

or

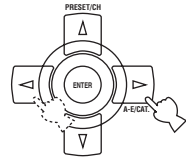

Remote control

**4** To search a channel within all channels, press PRESET/TUNING/CH </> (or PRESET/CH Δ / ▽ on the remote control) repeatedly.



Front panel

or

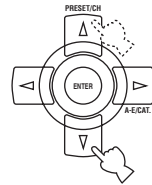

Remote control



You can search a channel with the quick search by pressing and holding PRESET/TUNING/CH </> (or PRESET/CH Δ / ▽ on the remote control).

■ **Category Search mode**

(U.S.A. model)

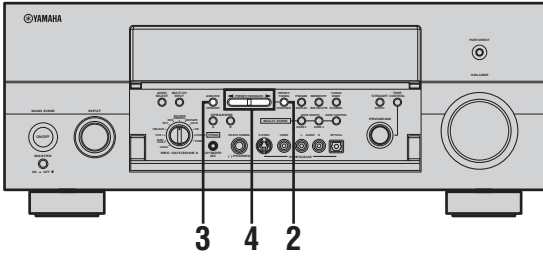

**1** Carry out “Selecting the XM Satellite Radio mode” on page 56.

**2** Press SEARCH MODE (or SRCH MODE on the remote control) repeatedly to select CAT SEARCH.

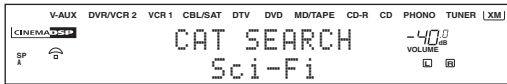
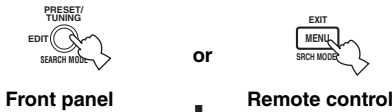

**3** To change the channel category, press CATEGORY (or A-E/CAT. </> on the remote control) repeatedly.

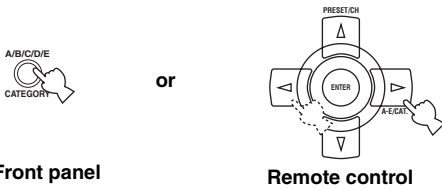

**4** To search a channel within the selected channel category, press PRESET/TUNING/CH </> (or PRESET/CH Δ / ▽ on the remote control) repeatedly.

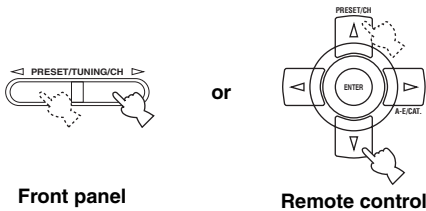

You can search a channel with the quick search by pressing and holding PRESET/TUNING/CH </> (or PRESET/CH Δ / ▽ on the remote control).

■ **Preset Search mode**

Prior to selecting a preset channel in the Preset Search mode, you should preset XM Satellite Radio channels. For details, see “Setting XM Satellite Radio preset channels” on page 60. All preset channels (A1 to E8) recalls 001 Preview by the factory setting.

(U.S.A. model)

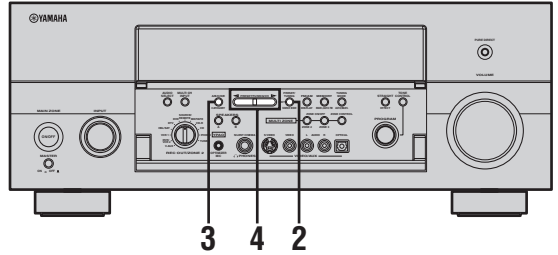

**1** Carry out “Selecting the XM Satellite Radio mode” on page 56.

**2** Press SEARCH MODE (or SRCH MODE on the remote control) repeatedly to select PRESET SEARCH.

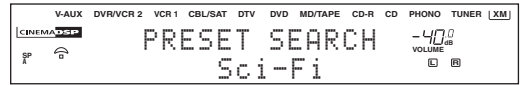
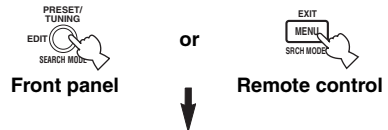

**3** To change the preset group (A to E), press CATEGORY (or A-E/CAT. </> on the remote control) repeatedly.

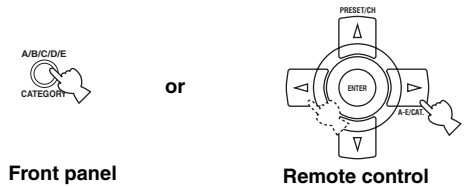

- 4** To change the preset number (1 to 8), press **PRESET/TUNING/CH**  $\triangleleft$  /  $\triangleright$  (or **PRESET/CH**  $\triangle$  /  $\nabla$  on the remote control) repeatedly.

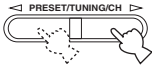

Front panel

or

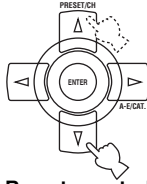

Remote control



You can also select the preset number directly by pressing the numeric buttons (1 to 8) on the remote control.

■ **Direct Number Access mode**

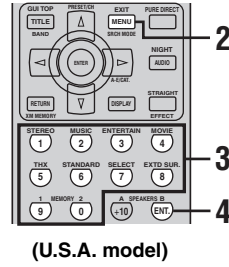

- 1** Carry out “Selecting the XM Satellite Radio mode” on page 56.
- 2** Press **SEARCH MODE** (or **SRCH MODE** on the remote control) repeatedly to select **ALL CH SEARCH** or **CAT SEARCH**.



Front panel

or



Remote control

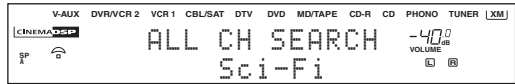

or

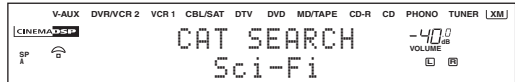

**3 Press the numeric buttons to enter the desired channel number.**

For example, to enter the number 123, press the numeric buttons as shown below.



The display changes as follows.

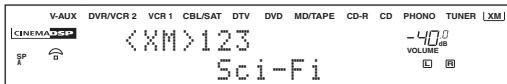
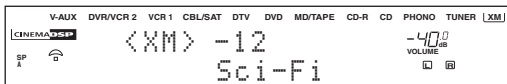

**4 If you enter fewer than three numbers, you may press ENT. to tune to the channel immediately or wait a few seconds to confirm the entered channel number.**



- If no button is pressed within a few seconds after entering one-digit or two-digit number, the unit automatically confirms the entered channel number.
- Pressing a button other than numeric buttons or ENT. cancels the direct number access procedure.

**Setting XM Satellite Radio preset channels**

You can use this feature to store up to 40 XM Satellite Radio channels (eight preset numbers in five preset groups, A1 to E8). You can then recall any preset channel easily by selecting the preset group and number as described in “Preset Search mode” on page 58.

(U.S.A. model)

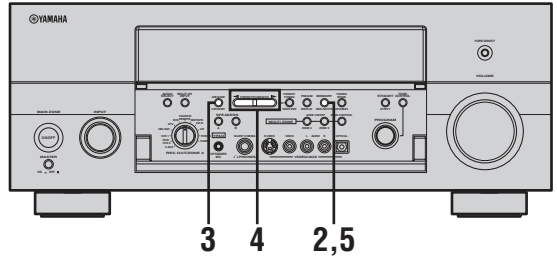

**1 Search the XM Satellite Radio channel you want to set as a preset channel.**

To search the desired channel, carry out “All Channel Search mode” on page 57, “Category Search mode” on page 58, or “Direct Number Access mode” on page 59.

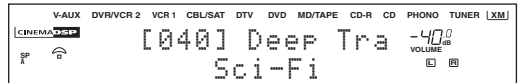

When the channel number 040 is selected

**2 Press MEMORY on the front panel (or XM MEMORY on the remote control) when XM is selected as the input source.**

The MEMORY indicator flashes in the front panel display for about five seconds.



or



Front panel

Remote control

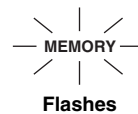



- 3** While the MEMORY indicator is flashing, press CATEGORY (or A-E/CAT. </> on the remote control) to select a preset group (A to E).

The group letter appears.

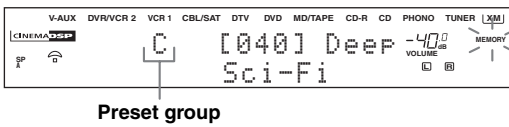
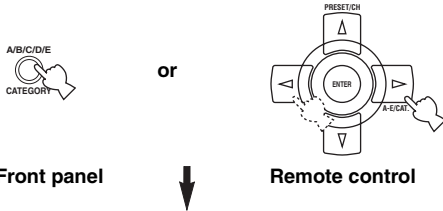

Preset group

- 5** While the MEMORY indicator is flashing, press MEMORY on the front panel (or XM MEMORY on the remote control) to preset the selected XM Satellite Radio channel.

A colon appears next to the preset number for confirmation, and the MEMORY indicator turns off.

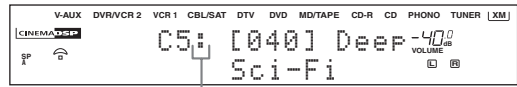
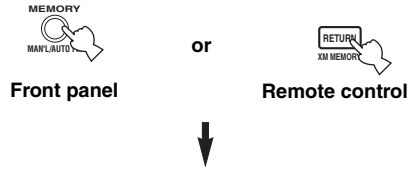

Colon appears

- 4** While the MEMORY indicator is flashing, press PRESET/TUNING/CH </> (or PRESET/CH Δ / ▽ on the remote control) to select a preset number (1 to 8).

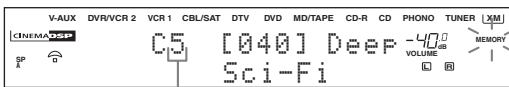
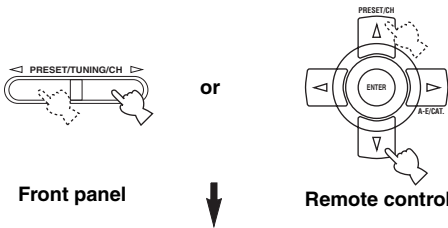

Preset number

**Note**

Presetting a new channel clears the former preset channel stored in the same preset group and number.

## Displaying the XM Satellite Radio information

You can display XM information (such as channel number/name, category, or artist name/song title) for the channel currently selected in the GUI and in the front panel display.

### Note

If a status message or an error message appears in the front panel display, see TROUBLESHOOTING on page 124.

### ■ Displaying the XM Satellite Radio information in the GUI

Press and hold DISPLAY on the front panel or on the remote control for approximately 3 seconds. The following screen is displayed in the GUI.

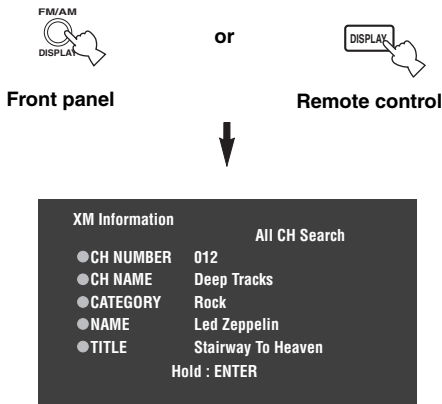

Press DISPLAY on the front panel or on the remote control briefly to exit from the XM Satellite Radio information display in the GUI.

### Notes

- To hold the XM Satellite Radio information screen, press ENTER on the remote control while it is being displayed in the GUI.
- The XM Satellite Radio information screen on hold is released if you press ENTER on the remote control again or if you change the XM Satellite Radio channel.
- This unit can save up to two XM Satellite Radio information screens for future reference. To view the previous two XM Satellite Radio information screens, press TITLE on the remote control repeatedly while the current XM Satellite Radio information screen is being on hold.

### ■ Displaying the XM Satellite Radio information in the front panel display

Press DISPLAY on the front panel or on the remote control repeatedly to toggle between the following XM information display modes.

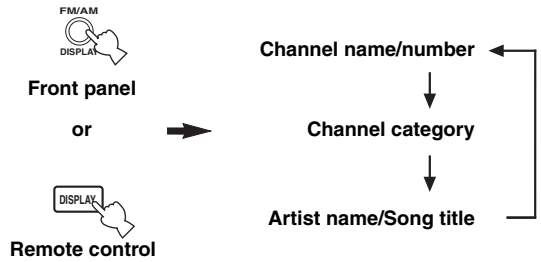

When the channel number/name is displayed:

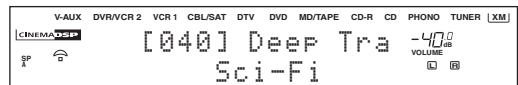

When the channel category is displayed:

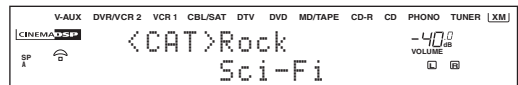

When the artist name/song title is displayed:

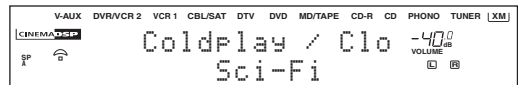

- The front panel display can indicate up to 14 alphanumeric characters at once. If the information contains more than 14 characters, the information scrolls from right to left.
- If the information contains a character that cannot be recognized by the unit, the character will be displayed with an underbar “\_”.

# EDITING SOUND FIELD PARAMETERS

## What is a sound field?

A significant factor that creates the rich, full tones of a live instrument are the multiple reflections from the walls of the room. In addition to making the sound live, these reflections enable us to tell where the player is situated, and the size and shape of the room in which we are sitting.

### ■ Elements of a sound field

In any environment, in addition to the direct sound coming straight to our ears from the player's instrument, there are two distinct types of sound reflections that combine to make up the sound field:

#### Early reflections

Reflected sounds reach our ears extremely rapidly (50 ms – 100 ms after the direct sound), after reflecting from one surface only — for example, from the ceiling or a wall. Early reflections help add clarity to the direct sound.

#### Reverberations

These are caused by reflections from more than one surface — walls, ceiling, the back of the room — so numerous that they merge together to form a continuous sonic afterglow. They are non-directional, and lessen the clarity of the direct sound.

Direct sound, early reflections and subsequent reverberation taken together help us to determine the subjective size and shape of the room, and it is this information that the digital sound field processor reproduces in order to create sound fields.

If you could create the appropriate early reflections and subsequent reverberations in your listening room, you would be able to create your own listening environment. The acoustics in your room could be changed to those of a concert hall, a dance floor, or virtually any size room at all. This ability to create sound fields at will is exactly what YAMAHA has done with the digital sound field processor.

## Changing parameter settings

You can enjoy good quality sound with the factory preset parameters. Although you do not have to change the initial settings, you can change some of the parameters to better suit the input source or your listening room. The following parameters are not always found in every program.

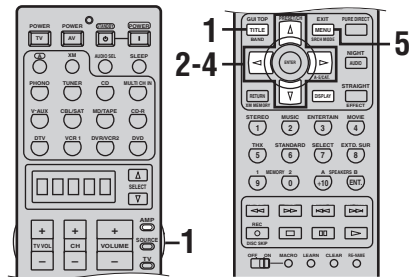

(U.S.A. model)

### 1 Set AMP/SOURCE/TV to AMP and then press GUI TOP on the remote control.

The top display appears.

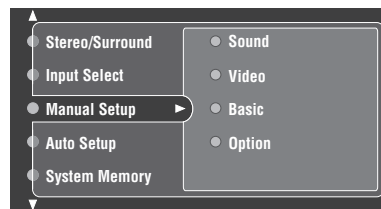
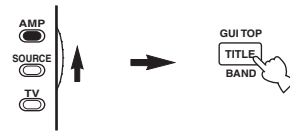

- 2 Press  $\Delta$  /  $\nabla$  repeatedly to select Stereo/Surround and then press  $\triangleright$ .**

The following display appears.

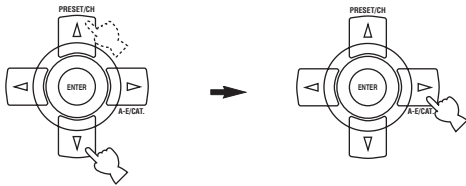

- 3 Press  $\Delta$  /  $\nabla$  repeatedly to select the sound field program you want to adjust and then press  $\triangleright$ .**

The following display appears.

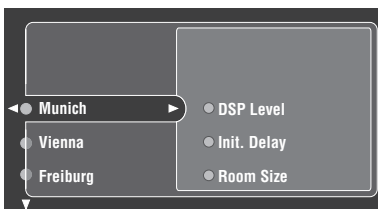
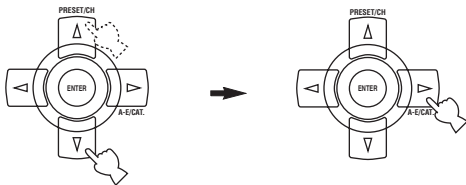

- 4 Press  $\Delta$  /  $\nabla$  repeatedly to select the sound field parameter you want to adjust and then press  $\triangleright$ .**

See "SOUND FIELD PARAMETER DESCRIPTIONS" on page 68 for detailed descriptions of each sound field parameter.

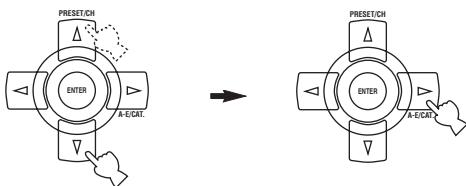

- 5 Press EXIT on the remote control to exit.**



**Note**

You cannot change parameter values when Memory Guard is set to On. If you want to change the parameter values, set Memory Guard to Off (see page 98).

**Memory back-up**

The memory back-up circuit prevents the stored data from being lost. However, the stored data will be lost in case the power cord is disconnected from the AC wall outlet for more than one week.

**■ Initializing sound field programs**

To initialize each sound field program individually

- 1 Repeat steps 1 to 3 to select the sound field program you want to reset and then press  $\triangleright$ .**
- 2 Press  $\Delta$  /  $\nabla$  repeatedly to select Initialize.**
- 3 Press EXIT on the remote control to exit.**



**To initialize all sound field programs**

Use the Sur.Initialize parameter in the Option menu (see page 98).

# SOUND FIELD PROGRAM DESCRIPTIONS

This unit is equipped with a variety of precise digital decoders that allow you to enjoy multi-channel playback from almost any sound source (stereo or multi-channel). This unit is also equipped with a YAMAHA digital sound field processing (DSP) chip containing several sound field programs which you can use to enhance your playback experience. Most of these sound field programs are precise digital recreations of actual acoustic environments found in famous concert halls, music venues, and movie theaters.



The YAMAHA CINEMA DSP modes are compatible with all Dolby Digital, DTS, and Dolby Surround sources. Set the input mode to AUTO (see page 44) to enable this unit to automatically switch to the appropriate digital decoder according to the input signal.

## Notes

- This unit's DSP sound field programs are recreations of real-world acoustic environments made from precise measurements taken in actual halls, etc. Thus you may notice variations in the strength of the reflections coming from the front, back, left and right.
- Feel free to choose a sound field program based on your listening preference, and not purely on the name of the program itself.

## For movie/video sources

You can select from the following sound fields when playing movie or video sources. The sound fields marked MULTI can be used with multi-channel sources, like DVD, digital TV, etc. Those marked 2-CH can be used with 2-channel (stereo) sources like TV programs, video tapes, etc.

**Program selection methods vary depending on sound field program types. For details on how to select sound field programs, see "Basic operations" on page 37.**

Sources	Remote control button	Category and Program	Features
MULTI 2-CH	1	STEREO 2ch Stereo	Downmixes multi-channel sources to 2 (left and right) channels or plays back 2-channel sources as is.
	3	ENTERTAINMENT TV Sports	CINEMA DSP processing. Though the presence sound field is relatively narrow, the surround sound field employs the sound environment of a large concert hall. This effect enhances the experience of watching various TV programs such as news, variety shows, music programs or sports programs.
		ENTERTAINMENT Mono Movie	CINEMA DSP processing. This program is provided for reproducing monaural video sources (such as old movies). The program produces the optimum reverberation to create sound depth using only the presence sound field.
		ENTERTAINMENT Game	CINEMA DSP processing. This program adds a deep and spatial feeling to video game sounds.
	4	MOVIE THEATER Spectacle	CINEMA DSP processing. This program creates the extremely wide sound field of a 70-mm movie theater. It precisely reproduces the source sound in detail, making both the video and the sound field incredibly real. This is ideal for any kind of video source encoded with Dolby Surround, Dolby Digital or DTS (especially large-scale movie productions).
		MOVIE THEATER Sci-Fi	CINEMA DSP processing. This program clearly reproduces dialog and sound effects in the latest sound form for science fiction films, thus creating a broad and expansive cinematic space amid silence. You can enjoy science fiction films in a virtual-space sound field that includes Dolby Surround, Dolby Digital and DTS-encoded software employing the most advanced techniques.
		MOVIE THEATER Adventure	CINEMA DSP processing. This program is ideal for precisely reproducing the sound design of the newest 70-mm and multichannel soundtrack films. The sound field is made to be similar to that of the newest movie theaters, so the reverberations of the sound field itself are restrained as much as possible.
		MOVIE THEATER General	CINEMA DSP processing. This program is for reproducing sounds from 70-mm and multichannel soundtrack films, and is characterized by soft and extensive sound field. The presence sound field is relatively narrow. It spatially spreads all around and toward the screen, restraining the echo effect of conversations without losing clarity.

**SOUND FIELD PROGRAM DESCRIPTIONS**

Sources	Remote control button	Category and Program	Features
MULTI 2-CH	5	THX Cinema	THX processing for movie software.
		THX THX Game	THX processing for game software.
MULTI	5	THX THX Select2 Cinema	THX Select2 processing for movie software.
	6	STANDARD DOLBY DIGITAL	Standard 5.1 channel processing for Dolby Digital sources.
		STANDARD DOLBY DIGITAL DOLBY D+PLIIx Movie	Standard 7.1 channel processing for Dolby Digital sources.
		STANDARD DOLBY D EX	Standard 6.1 channel processing for Dolby Digital sources.
		STANDARD DTS	Standard 5.1 channel processing for DTS sources.
		STANDARD DTS 96/24	Standard 5.1 channel processing for 96kHz/24-bit DTS sources.
		STANDARD DTS+PLIIx Movie	Standard 7.1 channel processing (Dolby Pro Logic IIx) for DTS sources.
		STANDARD DTS+DOLBY EX	Standard 6.1 channel processing (Dolby Digital EX) for DTS sources.
		STANDARD DTS ES	Standard 6.1 channel processing (DTS-ES Matrix and DTS-ES Discrete) for DTS sources.
		STANDARD DTS 96/24 ES	Standard 6.1 channel processing (DTS-ES Matrix and DTS-ES Discrete) for 96kHz/24-bit DTS sources.
		STANDARD Enhanced	CINEMA DSP enhanced processing for the selected decoder.
2-CH	STANDARD Pro Logic	Standard processing for Dolby Surround sources.	
	STANDARD PLIIx Movie	Dolby Pro Logic IIx processing for movie software.	
	STANDARD PLIIx Game	Dolby Pro Logic IIx processing for game software.	
	STANDARD Neo:6 Cinema	DTS processing for movie software.	
	STANDARD Enhanced	CINEMA DSP enhanced processing for the selected decoder.	

## For music sources

You can select from the following sound fields when playing music sources, like CD, FM/AM broadcasting, tapes, etc.

**Program selection methods vary depending on sound field program types. For details on how to select sound field programs, see “Basic operations” on page 37.**

Sources	Remote control button	Program	Features
MULTI 2-CH	1	STEREO 2ch Stereo	2 channel (left and right) playback.
		STEREO 7ch Stereo	HiFi DSP processing. Use to increase the output stereo sources (in stereo) from all speakers. This provides a larger sound field and is ideal for background music at parties, etc.
	2	MUSIC Munich	HiFi DSP processing. This is a large fan-shaped concert hall which has approximately 2500 seats. Almost the whole interior is made of wood. There is relatively little reflection from the walls, and sound spreads finely and beautifully.
		MUSIC Vienna	HiFi DSP processing. A classic shoe-box type concert hall with approximately 1700 seats. Pillars and ornate carvings create extremely complex reflections which produce a very full, rich sound.
		MUSIC Freiburg	HiFi DSP processing. This program recreates the acoustic environment of a big church with a high dome and columns along each side. The reverberation delay is very long while the early reflections are smaller than with other sound field programs.
		MUSIC The Bottom Line	HiFi DSP processing. This is the sound field at stage front in “The Bottom Line”, a famous New York jazz club. The floor can seat 300 people to the left and right in a sound field offering real and vibrant sound.
		MUSIC The Roxy Theatre	HiFi DSP processing. The ideal program for lively, dynamic rock music. The data for this program was recorded at LA’s “hottest” rock club. The listener’s virtual seat is at the center-left of the hall.
		MUSIC Pop/Rock	CINEMA DSP processing. This program produces a vibrant atmosphere and lets you feel as if you are at an actual jazz or rock concert.
	MUSIC Classic/Opera	CINEMA DSP processing. This program provides excellent vocal depth and overall clarity by restraining excessive reverberation. The surround sound field is relatively moderate but it reproduces beautiful sound using data collected from a concert hall.	
	3	ENTERTAINMENT Disco	HiFi DSP processing. This program recreates the acoustic environment of a lively disco in the heart of a big city. The sound is dense and highly concentrated. It is also characterized by high-energy, “immediate” sound.
MULTI	5	THX THX Music	THX processing for all 5.1 encoded music sources.
	6	STANDARD D+PLIIx Music	Standard Dolby Digital and Dolby Pro Logic IIx processing for music sources.
		STANDARD DTS+PLIIx Music	Standard DTS and Dolby Pro Logic IIx processing for music sources.
		STANDARD PLIIx Music	Dolby Pro Logic IIx processing for music software.
		STANDARD Neo:6 Music	DTS processing for music software.
		STANDARD Enhanced	CINEMA DSP enhanced processing for the selected decoder.

# SOUND FIELD PARAMETER DESCRIPTIONS

You can adjust the values of certain digital sound field parameters so the sound fields are recreated accurately in your listening room. Not all of the following parameters are found in every program.

## ■ DSP Level (DSP level)

**Function:** Adjusts the level of all the DSP effect sounds within a narrow range.

**Description:** Depending on the acoustics of your listening room, you may want to increase or decrease the DSP effect level relative to the level of the direct sound.

**Control Range:** -6 dB to +3 dB

## ■ Init. Delay (Initial delay)

**Function:** Changes the apparent distance the sound source is from the reflection face by adjusting the delay between the direct sound and the first reflection heard by the listener.

**Description:** The smaller the value, the closer the reflection face seems to the sound source. The larger the value, the farther it seems. For a small room, set to a small value. For a large room, set to a large value.

**Control range:** 1 to 99 ms

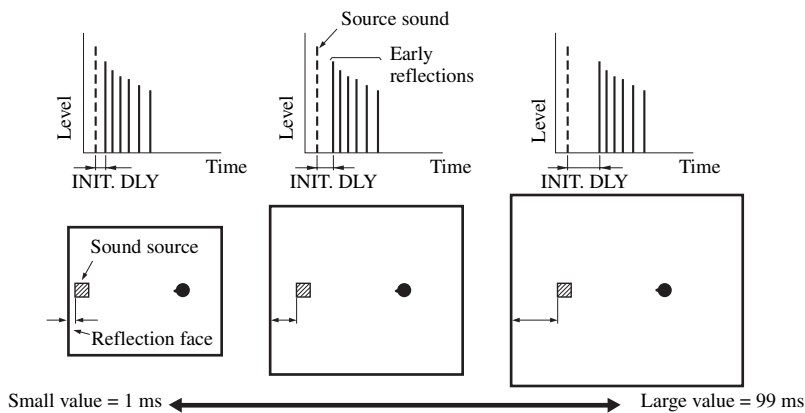

## ■ Room Size (Room size)

**Function:** Adjusts the apparent size of the surround sound field. The larger the value, the larger the surround sound field becomes.

**Description:** As the sound is repeatedly reflected around a room, the larger the hall is, the longer the time between the original reflected sound and the subsequent reflections. By controlling the time between the reflected sounds, you can change the apparent size of the virtual venue. Changing this parameter from one to two, doubles the apparent length of the room.

**Control range:** 0.1 to 2.0

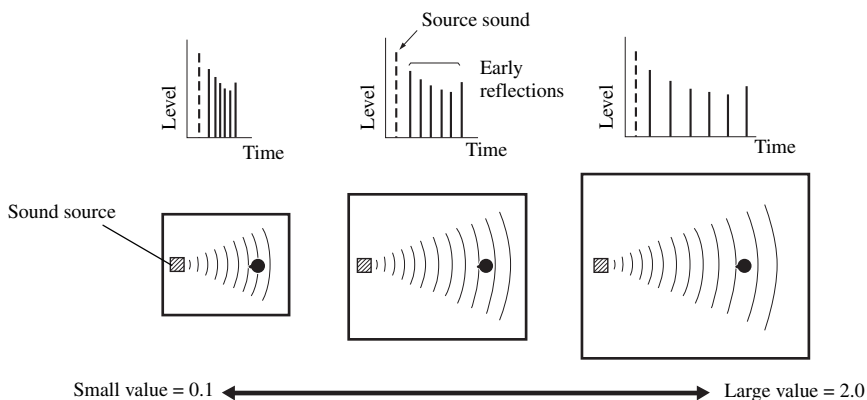



## ■ Liveness (Liveness)

**Function:** Adjusts the reflectivity of the virtual walls in the hall by changing the rate at which the early reflections decay.

**Description:** The early reflections of a source sound decay much faster in a room with acoustically absorbent wall surfaces than in one which has highly reflective surfaces. A room with acoustically absorbent surfaces is referred to as dead, while a room with highly reflective surfaces is referred to as live. The LIVENESS parameter lets you adjust the early reflection decay rate, and thus the liveness of the room.

**Control range:** 0 to 10

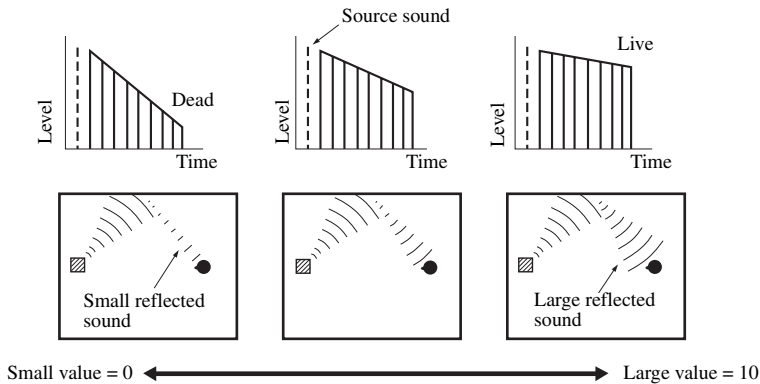

## ■ Sur. Init. Delay (Surround initial delay)

**Function:** Adjusts the delay between the direct sound and the first reflection on the surround side of the sound field. You can only adjust this parameter when at least two front channels and two surround channels are used.

**Control range:** 1 to 49 ms

## ■ Sur. Room Size (Surround room size)

**Function:** Adjusts the apparent size of the surround sound field.

**Control range:** 0.1 to 2.0

## ■ Sur. Liveness (Surround liveness)

**Function:** Adjusts the apparent reflectivity of the virtual walls in the surround sound field.

**Control range:** 0 to 10

## ■ SB. Init. Delay (Surround back initial delay)

**Function:** Adjusts the delay between the direct sound and the first reflection in the surround back sound field.

**Control range:** 1 to 49 ms

## ■ SB. Room Size (Surround back room size)

**Function:** Adjusts the apparent size of the surround back sound field.

**Control range:** 0.1 to 2.0

## ■ SB. Liveness (Surround back liveness)

**Function:** Adjusts the apparent reflectivity of the virtual wall in the surround back sound field.

**Control range:** 0 to 10

■ **Rev. Time (Reverberation time)**

**Function:** Adjusts the amount of time it takes for the dense, subsequent reverberation sound to decay by 60 dB (at 1 kHz). This changes the apparent size of the acoustic environment over an extremely wide range.

**Description:** The longer the reverberation time, the more live the listening room environment seems. The shorter the reverberation time, the more dead the listening room environment seems.

**Control range:** 1.0 to 5.0 s

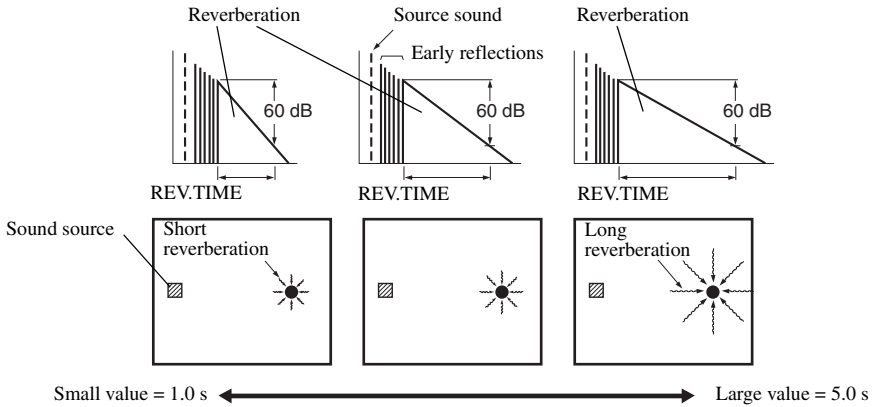

■ **Rev. Delay (Reverberation delay)**

**Function:** Adjusts the time difference between the beginning of the direct sound and the beginning of the reverberation sound.

**Description:** The larger the value, the later the reverberation sound begins. A later reverberation sound makes you feel like you are in a larger acoustic environment.

**Control range:** 0 to 250 ms

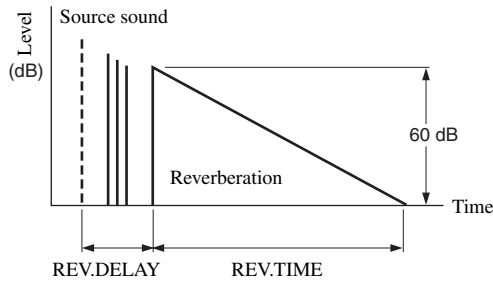

■ **Rev. Level (Reverberation level)**

**Function:** Adjusts the volume of the reverberation sound.

**Description:** The larger the value, the stronger the reverberation becomes.

**Control range:** 0 to 100%

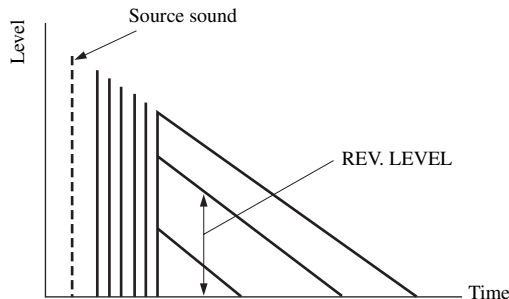

**■ Dialogue Lift (Dialog lift)**

- Function: Adjusts the height of the front and center channel sounds by assigning some of the front and center channel elements to the presence speakers.
- Description: The larger the parameter, the higher the position of the front and center channel sound.
- Choices: 0, 1, 2, 3, 4, 5

**For 2ch Stereo****Direct (Pure direct)**

- Function: Bypasses the decoders and DSP processors of this unit and shuts down the video circuitry to ensure the highest possible sound fidelity from analog and PCM sources.
- Choices: **Off**, Auto

**For 7ch Stereo**

- Function: Adjusts the volume level for each channel in 7-channel stereo mode.
- Control range: 0 to 100%

**Center Level (Center level)****Surround L Level (Surround left level)****Surround R Level (Surround right level)****Sur.Back Level (Surround back level)****Presence L Level (Presence left level)****Presence R Level (Presence right level)****For PLIIx Music****Panorama (Panorama)**

- Function: Extends the front stereo image to include the surround speakers for a wraparound effect.
- Choices: **Off**, On

**Center Width (Center width)**

- Function: Adjusts the center image from all three front speakers to varying degrees. A larger value adjusts the center image towards the front left and right speakers.
- Control range: 0 (center channel sound is output only from center speaker) to 7 (center channel sound is output only from front left and right speakers), initial setting is 3

**Dimension (Dimension)**

- Function: Gradually adjusts the sound field either towards the front or towards the rear.
- Control range: -3 (towards the rear) to +3 (towards the front), initial setting is STD (standard)

**For Neo:6 Music****Center Image (Center image)**

- Function: Adjusts the center image from all three front speakers to varying degrees.
- Control range: 0.0 to 1.0
- Initial setting: 0.3

**■ Decode Type (Decoder type)****For MOVIE THEATER**

Function: Selects the decoder used to playback 2-channel sources using MOVIE THEATER programs.  
Choices: Pro Logic / Pro Logic IIx / Neo:6

**For THX Cinema**

Function: Selects the decoder used to playback 2-channel sources using THX Cinema.  
Choices: Pro Logic / Pro Logic IIx / Neo:6

**For SURROUND Standard**

Function: Selects the decoder used to playback 2-channel sources using SURROUND Standard.  
Choices: Pro Logic / PLIIx Movie / PLIIx Music / PLIIx Game / Neo:6 Cinema / Neo:6 Music

**For SURROUND Enhanced**

Function: Selects the decoder used to playback 2-channel sources using SURROUND Enhanced.  
Choices: Pro Logic / Pro Logic IIx / Neo:6

**Note**

Pro Logic IIx appears when the surround back speakers are available.

**■ Initialize (Initialize)**

Function: Initializes each sound field program individually.  
Choices: **No**, Yes

**Note**

If you want to initialize all sound field programs, use the Sur.Initialize parameter in the Option menu (see page 98).

# SOUND FIELD PROGRAM SPEAKER LAYOUTS

Sound output from each speaker depends on the type of audio signals being input. Refer to the following diagrams in the table below to understand the speaker layout for each sound field program.

## Note

Be advised that there may be no or not enough sound output from speakers depending on the type of input source being played back. Furthermore, there may be some channels that can only be used partially when they are adjusted to specific aspects of movies, such as special sound effects, etc.

The abbreviations and symbols used in each diagram are as follows:

<b>L</b>	Front left speaker	<b>PL</b>	Presence left speaker	<b>SR</b>	Surround right speaker
<b>C</b>	Center speaker	<b>PR</b>	Presence right speaker	<b>SBL</b>	Surround back left speaker
<b>R</b>	Front right speaker	<b>SL</b>	Surround left speaker	<b>SBR</b>	Surround back right speaker



Speaker from which sound is being output



Speaker from which no sound is being output

\*1 When the **EX** / **PL IIx** / **ES** indicators are turned off

\*2 When the **EX** / **PL IIx** / **ES** indicators are lit up and PR/SB Priority is set to Presence (see page 86)

\*3 When the **EX** / **PL IIx** / **ES** indicators are lit up and PR/SB Priority is set to Surround Back (see page 86)

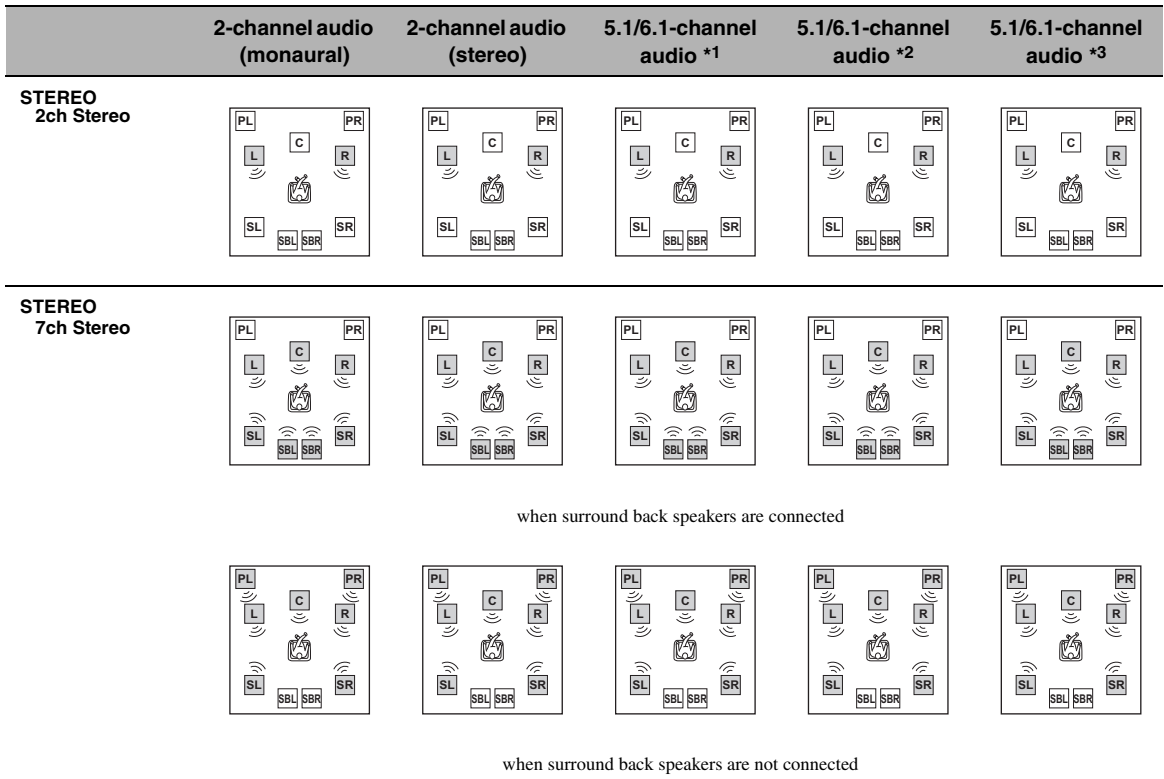

	2-channel audio (monaural)	2-channel audio (stereo)	5.1/6.1-channel audio *1	5.1/6.1-channel audio *2	5.1/6.1-channel audio *3
<b>MUSIC</b> Hall in Vienna The Bttm Line The Roxy Thtr ENTERTAINMENT Disco					
<b>MUSIC</b> Pop/Rock ENTERTAINMENT Variety/Sports Mono Movie Game					
<b>THX</b> THX Cinema THX Surround EX					
<b>THX</b> THX Select2 Cinema THX Music					
<b>THX</b> THX Game					
<b>STANDARD</b> DOLBY DIGITAL PRO LOGIC DTS					
	PRO LOGIC	PRO LOGIC			
<b>MOVIE THEATER</b> Enhanced DOLBY DIGITAL PRO LOGIC DTS					
	PRO LOGIC	PRO LOGIC			

	2-channel audio (monaural)	2-channel audio (stereo)	5.1/6.1-channel audio *1	5.1/6.1-channel audio *2	5.1/6.1-channel audio *3
--	-------------------------------	-----------------------------	-----------------------------	-----------------------------	-----------------------------

**STANDARD**  
 PLIIx Movie  
 PLIIx Music  
 PLIIx Game

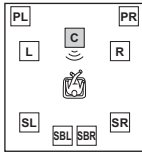

Movie/Game

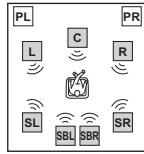

Movie/Music/Game

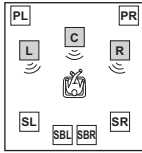

Music

**MOVIE THEATER**  
 Enhanced  
 PLIIx Movie

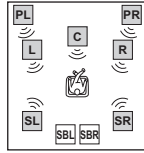
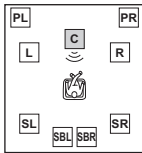

When PR/SB Priority  
 is set to Presence

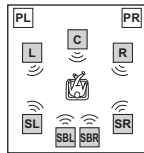

When PR/SB Priority  
 is set to Surround  
 Back

**STANDARD**  
 Neo:6 Cinema  
 Neo:6 Music

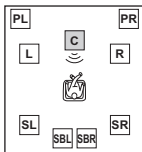

Cinema

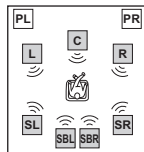

Cinema/Music

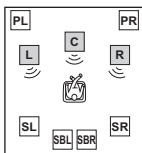

Music

	2-channel audio (monaural)	2-channel audio (stereo)	5.1/6.1-channel audio *1	5.1/6.1-channel audio *2	5.1/6.1-channel audio *3
<b>MOVIE THEATER</b> Enhanced Neo:6 Cinema					
		When PR/SB Priority is set to Presence			
			When PR/SB Priority is set to Surround Back		
<b>STRAIGHT</b>					
	Monaural playback				
<b>PURE DIRECT</b>					
	Monaural playback				



# SYSTEM OPTIONS

You can use the following parameters to adjust a variety of system settings and customize the way this unit operates. Change the initial settings (indicated in bold under each parameter) to reflect the needs of your listening environment.

## ■ Stereo/Surround (Stereo/Surround menu)

Use to edit sound field parameters (see page 63).

## ■ Input Select (Input select menu)

Use to reassign digital input/outputs, select the input signal, rename the inputs, or adjust the output volume of each jack (see page 80).

## ■ Manual Setup (Manual setup menu)

Use to manually adjust speaker and system settings (see page 83).

### Sound (Sound menu)

Use to manually adjust the sound parameters.

Item	Features	Page
LFE Level	Adjusts the output level of the LFE channel for Dolby Digital or DTS signals.	83
Dynamic Range	Adjusts the dynamic range for Dolby Digital or DTS signals.	84
Parametric EQ	Adjusts the parametric equalizer of each speaker.	84
Tone Control	Adjusts the tonal balance of speakers and headphones.	85
Audio Option	Customizes overall audio settings for this unit.	85
Channel Mute	Selects specific speaker channels to be muted.	87

### Video (Video menu)

Use to manually adjust the video parameters.

Item	Features	Page
Conversion	Converts the analog video signals.	88
Component I/P	Deinterlaces the analog video signals from 480i to 480p (NTSC) or 576i to 576p (PAL).	88
HDMI Up-Scaling	Up-scales the analog video signals to HDMI.	88
HDMI Aspect	Selects the HDMI aspect ratio.	89
Short Message	Displays short messages regarding system operations.	89
Position	Adjusts the vertical and horizontal position of the GUI display.	89
Wall Paper	Selects the background of the GUI display.	89

### Basic (Basic menu)

Use to manually adjust basic system parameters.

Item	Features	Page
Test Tone	Turns the test tone output on or off for Speaker Set, Speaker Distance and Speaker Level settings.	90
Speaker Set	Selects the output mode suitable for each speaker, the speakers for low-frequency signal output, and the cross over frequency.	90
Speaker Distance	Adjusts the delay time of each speaker.	92
Speaker Level	Adjusts the output level of each speaker.	93
THX Set	Adjusts the THX settings.	94

**Option (Optional menu)**

Use to manually adjust the optional system settings.

Item	Features	Page
Dimmer	Adjusts the GUI and front panel displays.	95
Multi Zone	Customizes the Zone 2, Zone 3 and Zone B settings.	95
Sur.Initialize	Initializes the parameters of all or a group of sound field programs.	98
Audio Select	Selects the initial input mode of the source.	98
Decoder Mode	Selects the decoder used by this unit.	98
Memory Guard	Locks the menu parameter settings.	98
HDMI Set	Adjusts the HDMI support audio.	99

■ **Auto Setup (Auto setup menu)**

Use to run AUTO SETUP and specify which speaker parameters to be adjusted (see page 32).

■ **System Memory (System memory menu)**

Use to save and recall various settings (see page 99).

■ **Signal Info. (Signal information menu)**

Use to check signal information (see page 45).

■ **Language (GUI language menu)**

Use to select the language of your choice that appears in the GUI (graphical user interface) menu of this unit (see page 100).



You can also select the GUI language using the LANG. parameter in ADVANCED SETUP in the front panel display (see page 102).

## Changing parameter settings

Use the remote control to access and adjust each parameter. (Speaker set is used in the following example to change parameter settings.)

Manual Setup > Basic > Speaker Set >

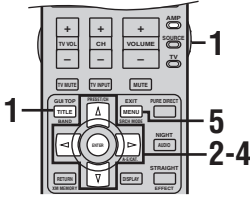

**1** Set AMP/SOURCE/TV to AMP and then press GUI TOP on the remote control.

The top display appears.

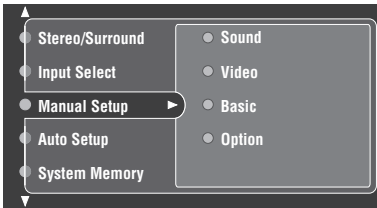

**2** Press  $\Delta / \nabla$  repeatedly to select a menu and then press  $\triangleright$  to enter the selected menu.

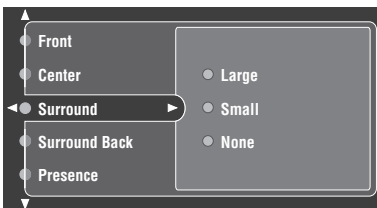
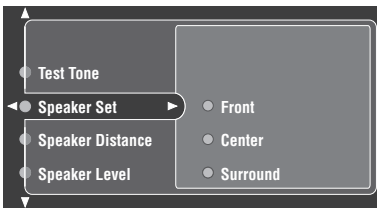

**3** Press  $\Delta / \nabla$  repeatedly to select the parameter you want to adjust.

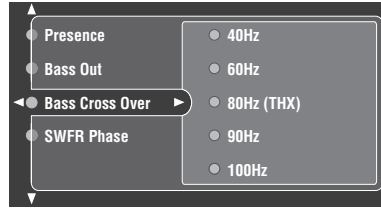

**4** Press ENTER or  $\triangleright$  and then press  $\Delta / \nabla$  repeatedly to change the setting of the item you want to adjust.

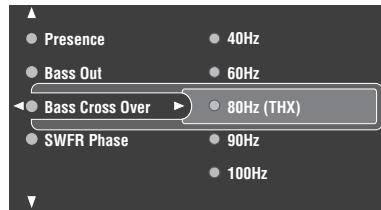

**5** Press EXIT.



If you want to continue adjusting parameter settings, press ENTER to return to the previously selected menu item.

### Notes

- The available parameters may be displayed on more than one page of the GUI display. To scroll through pages, press  $\Delta / \nabla$ .
- You cannot change parameter values when Memory Guard is set to "On". If you want to change the parameter values, set Memory Guard to "Off" (see page 98).

### Memory back-up

The memory back-up circuit prevents the stored data from being lost even if this unit is set in the standby mode, the power cable is disconnected from the AC outlet, or the power supply is temporarily cut due to power failure. However, if the power is cut for more than one week, the parameter values will return to the factory settings. If this happens, edit the parameter value again.

## Input Select

Use this feature to reassign digital input/outputs, select the input signal, rename the inputs, or adjust the level of the signal input at each jack.

Choices: XM, TUNER, PHONO, CD, CD-R, MD/TAPE, DVD, DTV, CBL/SAT, VCR1, DVR/VCR2, V-AUX, MULTI CH

**Note**

Some parameters described below may not be available for all input sources and some parameters are only available for specific input sources.

Input source	Parameter
XM	Antenna Level Volume Trim Rename
TUNER	Volume Trim Rename
PHONO CD CD-R MD/TAPE DVD DTV CBL/SAT VCR1 DVR/VCR2	I/O Assignment Audio Select Decoder Mode Volume Trim Rename
V-AUX	Audio Select Decoder Mode Volume Trim Rename
MULTI CH	Volume Trim Multi CH Assign

**1 Set AMP/SOURCE/TV to AMP and then press GUI TOP on the remote control.**

The top display appears.

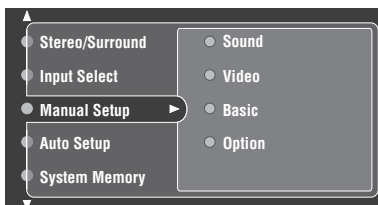

**2 Select Input Select and then press >.**

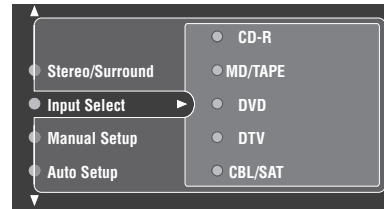

**3 Select the desired input source (CD, DVD, etc.) and then press > to access and adjust.**

**Antenna Level (Antenna level)**

Use to display the XM Satellite Radio reception level.

Input Select > XM > Antenna Level >

Display status: NONE, 0 to 100%

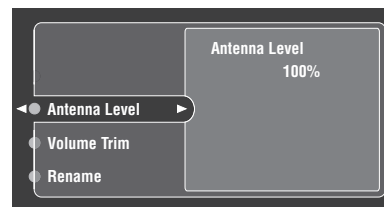

- If the displayed percentage of the reception level is below the average (approximately 60%), you need to adjust the orientation of the XM Satellite Radio antenna for a better percentage of the reception level.
- If NONE is displayed, the XM Satellite Radio antenna may not be firmly connected to the XM jack on the rear panel of this unit. Check the XM Satellite Radio connection.

**Note**

The Antenna Level parameter cannot be adjusted by using the remote control. Instead, you need to adjust the orientation of the XM Satellite Radio antenna for a better percentage of the reception level.

## ■ Volume Trim (Volume trimming)

You can adjust the level of the signal input at each jack. This is useful if you want to balance the level of each input source to avoid sudden changes in volume when switching between input sources.

Manual Setup > Input Select > input source (DVD, etc.) > Volume Trim >

Control range: -6.0 dB to +6.0 dB

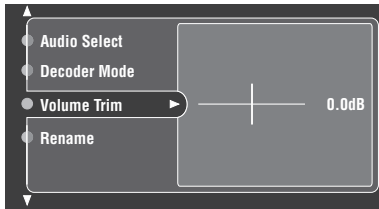

### Note

You can only adjust the volume for the current input source using this setting.

## ■ Rename (Rename)

Use this feature to change the name of the inputs in the GUI or the front panel display menu. (DVD is used as the source component in the following example.)

Input Select > input source (DVD, etc.) > Rename

**1 Press an input selector button to select the input you want to change the name of.**

**2 Press < / > to place the \_ (under-bar) under the space or character you want to edit.**

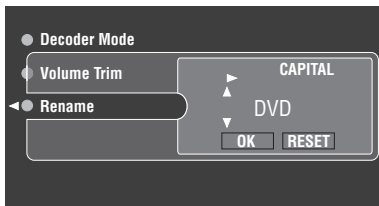

**3 Press ENTER to select a character type (CAPITAL/SMALL/FIGURE/MARK).**

**4 Press Δ / ▽ to select the character you want to use and < / > to move to the next one.**

- You can use up to 8 characters for each input.
- Press ▽ to change the character in the following order, or press Δ to go in the reverse order. Press ENTER to switch between character types:
  - CAPITAL A to Z, space
  - SMALL a to z, space
  - FIGURE 0 to 9, space
  - MARK !, #, %, &, etc.
- Repeat steps 1 to 3 to rename each input.

**5 Press < / > to select OK and press ENTER when complete.**



To change source names in the display window on the remote control, see page 109.

### Note

You can only change the name of the current input source (except for multi channel input sources) using this setting.

## ■ I/O Assignment (Input/output assignment)

You can assign the digital audio input/output and component video jacks to other components if this unit's initial settings do not correspond to your needs. Change the following parameters to reassign the jacks and effectively connect more components.

Once the jacks are reassigned, you can select the corresponding component using the INPUT selector on the front panel or the input selector buttons on the remote control.

Input Select > input source (DVD, etc.) > I/O Assignment >

### Example 1:

- To assign the COAXIAL ⑦ (CD) jack to the DVD input.
- Select Input Select and then select DVD.
  - Select I/O Assignment > Coaxial Input and then select ⑦ CD.

### Example 2:

To clear a jack assignment.

- Select Input Select and then select the input source (DVD, etc.).
- Select I/O Assignment and then select the jack assignment (Coaxial Input, Optical Input, Optical Output, Component Video, or HDMI).
- Select NONE and then press ENTER to clear the assignment.

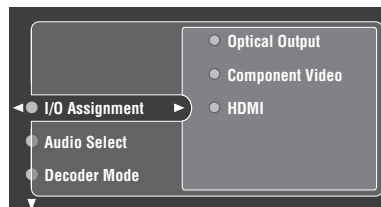

### Notes

- You cannot select a specific item more than once for the same type of jack.
- When you connect a component to both the COAXIAL and OPTICAL jacks, priority is given to signals input at the COAXIAL jack.

## ■ Audio Select (Audio selection)

This unit comes with a variety of input jacks. You can select the type of input signal you want to use.

Input Select > input source (DVD, etc.) > Audio Select > Choices: **Auto**, HDMI, Coax/Opt, Analog

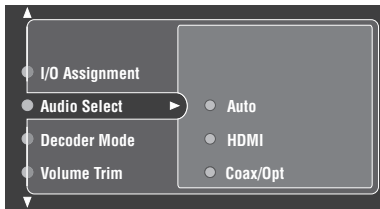

- Select “Auto” if you want signals to be input to this unit in the following order: HDMI signals, digital signals\* and analog signals.
- Select “HDMI” if you only want HDMI signals to be input to this unit. If no HDMI signals are input, no sound is output.
- Select “Coax/Opt” if you want digital signals to be input to this unit at the OPTICAL or COAXIAL jacks. Use if HDMI signals are also being input.
- Select “Analog” if you only want analog signals to be input to this unit. If no analog signals are input, no sound is output.

\* If this unit detects a Dolby Digital or DTS signal, the decoder automatically switches to the appropriate sound field program.



- You can adjust the default input mode this unit selects when the power is turned on (see page 98).
- DTS mode is recommended for playback of a CD or LD encoded in DTS.

### Notes

- If the digital output data of the player has been processed in any way, you may not be able to perform DTS decoding even if you make a digital connection between this unit and the player.
- The parameter setting for Decoder Mode takes priority over the one for Audio Select. As a result, if Decoder Mode is set to a setting other than Auto and Audio Select to Analog, there will be no audio output. To resume audio output, set Decoder Mode to Auto or set Audio Select to a setting other than Analog.

## ■ Decoder Mode (Decoder mode)

Use this feature to switch the input mode. You can designate the reassigned digital input jacks (see page 81) for specific audio signals (DTS, etc.).

Input Select > input source (DVD, etc.) > Decoder Mode > Choices: **Auto**, DTS

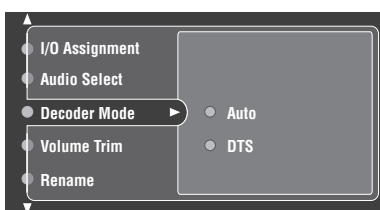

- Select “Auto” if you want this unit to automatically detect input signal types and select the appropriate input mode.
- Select “DTS” if you want this unit to select DTS as the input mode.
- The parameter setting for Decoder Mode takes priority over the one for Audio Select. As a result, if Decoder Mode is set to a setting other than Auto and Audio Select to Analog, there will be no audio output. To resume audio output, set Decoder Mode to Auto or set Audio Select to a setting other than Analog.

## ■ Multi CH Assign (Multi channel assignment)

Use this feature to set the direction of the signals input into the center, subwoofer and surround channels when a source component is connected to the MULTI CH INPUT jacks. If you are inputting 8-channel signals from an external decoder, use this feature to select jacks for the additional front signals.

Input Select > MULTI CH > Multi CH Assign >

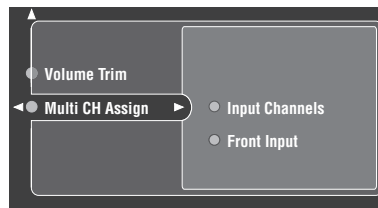

### Input Channels (Input channels)

This setting is used to select the number of channels input from an external decoder.

Choices: **6ch**, 8ch

### Note

If Zone2 Amplifier (page 96) is set to “Internal”, no sound is output from the surround back speakers even if you select “8ch”. In this case, select “6ch” and set the output setting of the external component to 6 channels.

### Front Input (Front input)

If you selected “8ch” in Input Channels, you can select analog jacks at which front signals from an external decoder will be input.

Choices: **DVD**, DTV, CBL/SAT, VCR1, DVR/VCR2, V-AUX, CD, CD-R, MD/TAPE

## Manual Setup (Sound)

Use this menu to adjust the sound parameters.

- 1 Set AMP/SOURCE/TV to AMP and then press GUI TOP on the remote control.

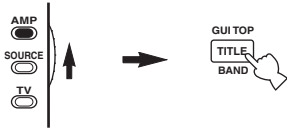

- 2 Press  $\Delta$  /  $\nabla$  on the remote control to select Manual Setup and then press  $\triangleright$ .

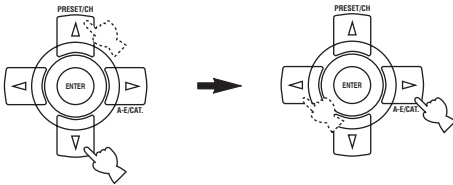

- 3 Press  $\Delta$  /  $\nabla$  on the remote control to select Sound and then press  $\triangleright$ .

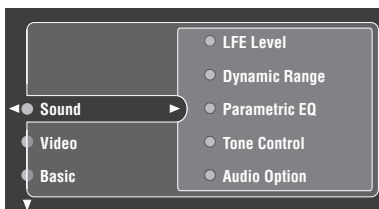
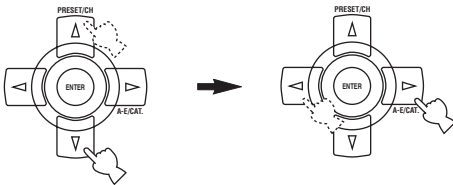

- 4 Select the desired parameters and then press  $\triangleright$  to access and adjust.

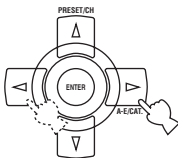

### LFE Level (Low-frequency effect level)

Use to adjust the output level of the LFE (low-frequency effect) channel according to the capacity of your subwoofer or headphones. The LFE channel carries low-frequency special effects which are only added to certain scenes. This setting is effective only when this unit decodes Dolby Digital or DTS signals.

To access these parameters, select:

Manual Setup > Sound > LFE Level >

Control range: -20.0 to 0.0 dB

Control step: 1 dB

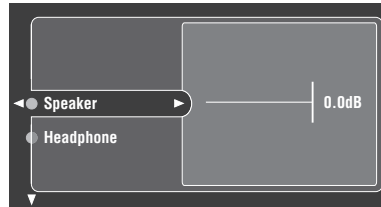

#### Speaker (Speaker low-frequency effect level)

Select to adjust the speaker LFE level.

#### Headphone (Headphone low-frequency effect level)

Select to adjust the headphone LFE level.

#### Note

Depending on the settings of LFE Level, some signals may not be output at the SUBWOOFER jack.

## ■ Dynamic Range (Dynamic range)

Use to select the amount of dynamic range compression to be applied to your speakers and headphones. This setting is effective only when the unit is decoding Dolby Digital and DTS signals.

To access these parameters, select:

Manual Setup > Sound > Dynamic Range >

Choices: **MAX** (maximum), **STD** (standard), **MIN** (minimum)

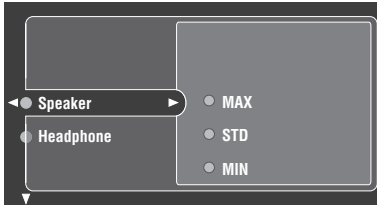

### Speaker (Speaker dynamic range)

Select to adjust the speaker compression.

### Headphone (Headphone dynamic range)

Select to adjust the headphone compression.

- Select “MAX” to preserve the greatest amount of dynamic range.
- Select “STD” for general use.
- Select “MIN” for listening to sources at low volume levels.

## ■ Parametric EQ (Parametric equalizer)

Use this feature to adjust the parametric equalizer of each speaker.

Manual Setup > Sound > Parametric EQ >

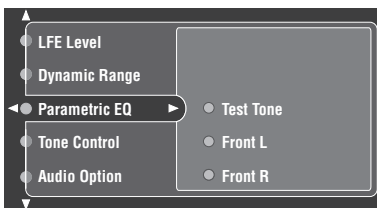

### 1 Press $\Delta$ / $\nabla$ to select Test Tone or the speaker you want to adjust.

- **Test Tone** turns on or off the test tone output when adjusting the tonal quality of each speaker.
- **Front L** adjusts the tonal quality of the front left speaker.
- **Front R** adjusts the tonal quality of the front right speaker.
- **Center** adjusts the tonal quality of the center speaker.
- **Surround L** adjusts the tonal quality of the surround left speaker.
- **Surround R** adjusts the tonal quality of the surround right speaker.
- **Surround Back L** adjusts the tonal quality of the surround back left speaker.
- **Surround Back R** adjusts the tonal quality of the surround back right speaker.
- **Presence L** adjusts the tonal quality of the presence left speaker.
- **Presence R** adjusts the tonal quality of the presence right speaker.

### 2 Press $\triangleright$ to access the settings window.

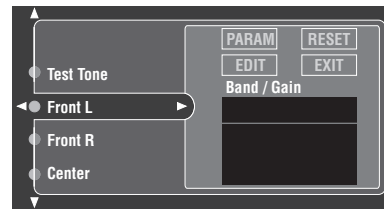

### 3 Press $\triangleleft$ / $\triangleright$ to select PARAM and then press ENTER to select a parameter from Band (band), Freq. (frequency) or Q (Q factor).

### 4 Press $\nabla$ to select EDIT and press ENTER to access the edit window.

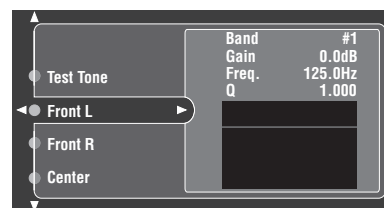

The parameter selected in PARAM is highlighted.

- Press  $\triangleleft$  /  $\triangleright$  to adjust the parameter.
- Press  $\Delta$  /  $\nabla$  to adjust the Gain.
- Press ENTER to exit the edit window.



## 5 Repeat steps 3 and 4 until you are satisfied with the results.



If you want to reset all PEQ parameter settings for the selected speaker, select RESET and press ENTER.

## 6 Select EXIT and press ENTER to exit the settings window.



- If you select “Band” in step 3, you can use this menu as a graphic equalizer.
- For more information on the parametric equalizer, see page 84.

## ■ Tone Control (Tone control)

Use to adjust the amount of bass and treble output to your speakers and headphones.

Manual Setup > Sound > Tone Control >

Choices: Control, Bass, Treble, Audio Bypass

### Note

Tone Control is not effective when:

- THX (see page 72) or PURE DIRECT (see page 71) is selected.
- MULTI CH INPUT is selected.

## Control (Tone control)

Choices: Speakers, Headphones

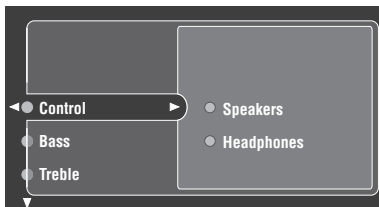

- Select “Speakers” to adjust the bass/treble balance of your speakers.
- Select “Headphones” to adjust the bass/treble balance of your headphones.

## Bass (Bass control)

Use this feature to adjust low-frequencies output to your speakers or headphones.

Choices: 125Hz, **350Hz**, 500Hz (frequency)

–6.0dB to +6.0dB (gain), initial setting: 0.0dB

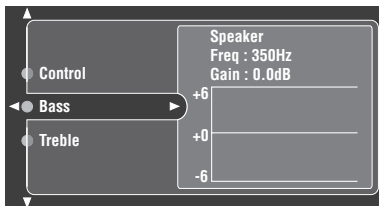

## Treble (Treble control)

Use this feature to adjust high-frequencies output to your speakers or headphones.

Choices: 2.5kHz, **3.5kHz**, 8.0kHz (frequency)

–6.0dB to +6.0dB (gain), initial setting: 0.0dB

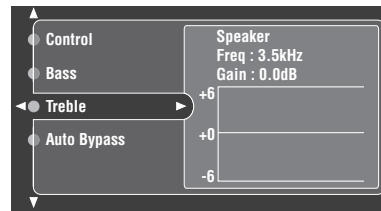

## Auto Bypass (Auto bypass)

Use to set this unit to automatically bypass any adjustments made for Tone Control.

Choices: **Auto**, Off

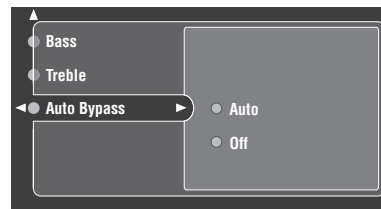

- Select “Auto” to set this unit to automatically bypass any Tone Control settings.
- Select “Off” to set this unit to reflect the Tone Control settings.

## ■ Audio Option (Audio options)

Use to customize this unit’s overall audio settings.

Manual Setup > Sound > Audio Option >

Choices: Muting Type, Audio Delay, Max Volume, Initial Volume, PR/SB Select

## Muting Type (Muting type)

Use to adjust how much the mute function reduces the output volume.

Choices: **Full**, –20dB

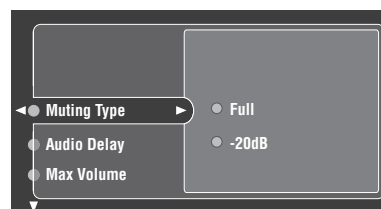

- Select “Full” to completely halt all output of sound.
- Select “–20dB” to reduce the current volume by 20 dB.

**Audio Delay (Audio delay)**

Use to delay the sound output and synchronize it with the video image. This may be necessary when using certain LCD monitors or projectors.  
Control range: **0** to 240 (ms)

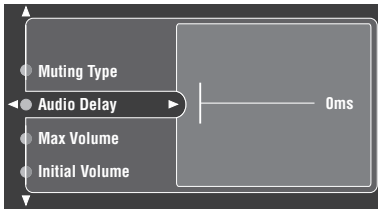

**Initial Volume (Initial volume)**

Use to set the volume level of the main room when the power of this unit is turned on.  
Choices: **Off**, -80dB to +16.5dB  
Control step: 0.5 dB

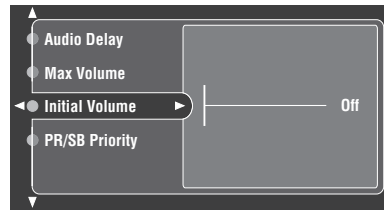

**Max Volume (Maximum volume)**

Use to set the maximum volume level so that the sound output level will not increase beyond the limited volume level. For example, the original volume range is -30.0 dB to -80 dB. However, if Max Volume is set to -5 dB, the volume range becomes -5 dB to -90 dB.  
Control range: **-30.0dB** to -80dB  
Control step: 5 dB

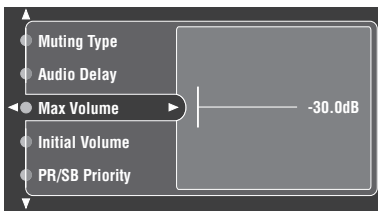

**Note**

The Max Volume setting (see above) takes priority over the Initial Volume setting. Therefore, Initial Volume cannot be set beyond the existing Max Volume setting.

**PR/SB Priority (Presence/surround back speaker priority)**

Surround back and presence speakers do not output sound simultaneously. You can select to prioritize either speaker set when playing sources that contain surround back channel signals using CINEMA DSP sound field programs.

Choices: Presence, **Surround Back**

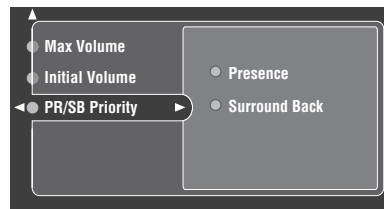

**Notes**

- When a test tone is output, the Max Volume setting is automatically deactivated because the volume level is automatically set to 0 dB regardless of the current Max Volume setting.
- The Max Volume setting takes priority over the Initial Volume setting (see below). For example, if Initial Volume is set to 5 dB and then Max Volume is set to 3 dB, the volume level is automatically set to 3 dB when you turn on the power of this unit next time. However, the Initial Volume setting is kept at 5 dB.

- Select “Presence” to use presence speakers even when surround back channel signals are input. The signals for the surround back channel will be output from surround speakers.
- Select “Surround Back” to use surround back speakers when a surround back channel signal is detected in a CINEMA DSP sound field program. Presence channel signals will be output from front speakers.

## ■ Channel Mute (Channel mute)

Use to select specific speaker channels to be muted.

Manual Setup > Sound > Channel Mute >

### Mode (Mode)

Use to activate or deactivate the Channel Mute setting for each speaker.

Choices: **Off**, **On**

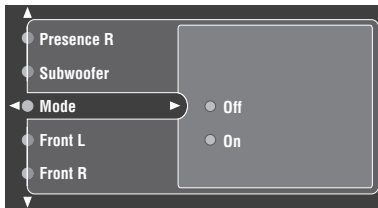

- Select “Off” to deactivate the Channel Mute settings.
- Select “On” to activate the Channel Mute settings.

### Speaker settings

Choices: Mute, **Off**

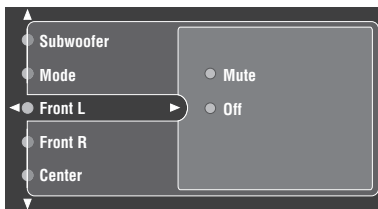

- Select “Mute” to mute the selected speaker channel.
- Select “Off” not to mute the selected speaker channel.
- **Front L** sets whether to mute the audio output from the front left speaker.
- **Front R** sets whether to mute the audio output from the front right speaker.
- **Center** sets whether to mute the audio output from the center speaker.
- **Surround L** sets whether to mute the audio output from the surround left speaker.
- **Surround R** sets whether to mute the audio output from the surround right speaker.
- **Surround Back L** sets whether to mute the audio output from the surround back left speaker.
- **Surround Back R** sets whether to mute the audio output from the surround back right speaker.
- **PRESENCE L** sets whether to mute the audio output from the presence left speaker.
- **PRESENCE R** sets whether to mute the audio output from the presence right speaker.
- **Subwoofer** sets whether to mute the audio output from the subwoofer.

## Manual Setup (Video)

Use this menu to adjust the video parameters.

- 1 Set AMP/SOURCE/TV to AMP and then press **GUI TOP** on the remote control.

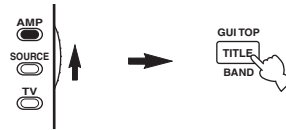

- 2 Press **Δ / ▽** on the remote control to select Manual Setup and then press **▷**.

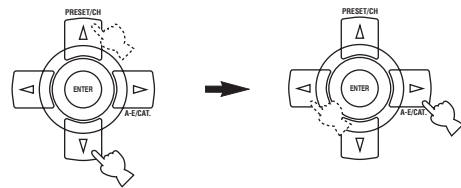

- 3 Press **Δ / ▽** on the remote control to select Video and then press **▷**.

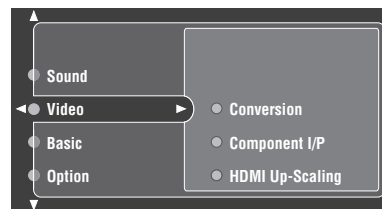
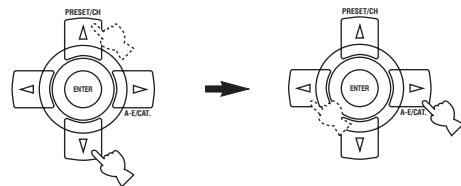

- 4 Select the desired parameters and then press **▷** to access and adjust.

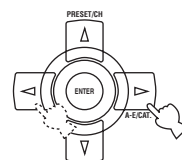

## ■ Conversion (Video conversion)

Use this feature to activate or deactivate the video conversion as well as the HDMI up-conversion of the analog video signals input at the composite video, S-video and component video jacks.

Choices: Off, **On**

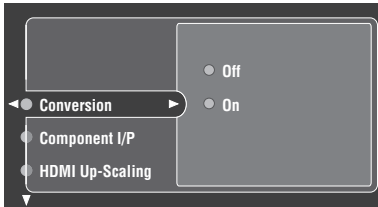

- Select “Off” to deactivate the video conversion as well as the HDMI up-conversion of the analog video signals.
- Select “On” to activate the video conversion as well as the HDMI up-conversion of the analog video signals.



For optimal video performance, THX recommends setting Conversion to Off.

### Notes

- Even when Conversion is set to On, HDMI digital signals are not converted to analog video signals.
- If Conversion is set to Off, the Component I/P and HDMI Up-Scaling features are deactivated.
- Converted video signals are only output at the MONITOR OUT jacks. When recording, you must make the same type of video connections (composite or S-video) between each component.
- When converting composite video or S-video signals from a VCR to component video signals, the picture quality may suffer depending on your VCR.
- The GUI display becomes grayed out under the following circumstances:
  - If Conversion is set to Off.
  - If the selected HDMI Up-Scaling setting is not supported by the HDMI component connected to the HDMI OUT jack on the rear panel of this unit.
  - If the resolution of the analog video signals being input is either 1080i or 720p.
  - If the selected HDMI Up-Scaling setting is lower than the resolution of the analog video signals being input.
- Unconventional signals (such as those output from a game console, etc.) input at the composite video, S-video or component video jacks cannot be converted even if Conversion is set to On.
- If unconventional signals are being input at the composite video, S-video or component video jacks, the video output may be abnormal as a result. In such cases, set Conversion to Off.
- Even if Conversion is set to Off, each video signal is converted to display the GUI display menu and is output at the MONITOR OUT jacks.

## ■ Component I/P (Component interlace/progressive)

Use this feature to activate or deactivate the analog I/P up-conversion of the analog video signals input at the composite, S-video and component video jacks so that the analog video signals deinterlaced from 480i to 480p (NTSC) or 576i to 576p (PAL) are output at the MONITOR OUT jacks.

Choices: **Off**, On

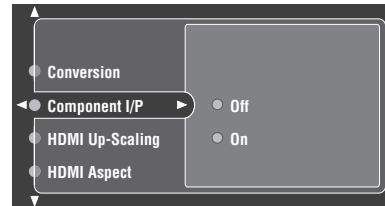

- Select “Off” to deactivate the analog I/P up-conversion of the analog video signals.
- Select “On” to activate the analog I/P up-conversion of the analog video signals.

### Notes

- This menu item is not available and hence not visible in the GUI menu if Conversion is set to Off.
- If your video monitor does not support the analog video signals with 480p of resolution, the system options menu items may not be displayed on your video monitor when Component I/P is set to On.

## ■ HDMI Up-Scaling (HDMI up-scaling)

Use this feature to activate or deactivate the HDMI up-conversion of the analog video signals input at the composite video, S-video and component video jacks so that the up-scaled analog video signals (480i (NTSC) or 576i (PAL) → 480p (NTSC) or 576p (PAL) /1080i/720p and 480p (NTSC) or 576p (PAL) → 1080i/720p) are output at the HDMI OUT jack.

Choices: Through, **480p** (NTSC) or **576p** (PAL), 1080i, 720p

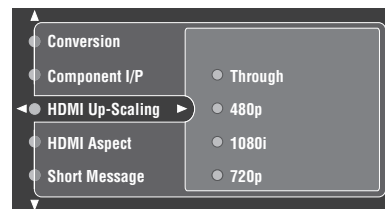

- Select “Through” not to up-scale any analog video signals.
- Select “480p” (NTSC) or “576p” (PAL), “1080i” or “720p” to up-scale analog video signals to 480p (NTSC) or 576p (PAL), 1080i or 720p of resolution.

### Note

This menu item is not available and hence not visible in the GUI menu if Conversion is set to Off.

## ■ HDMI Aspect (HDMI aspect ratio)

Use to select the HDMI aspect ratio.

Choices: **Through**, 16:9 Normal

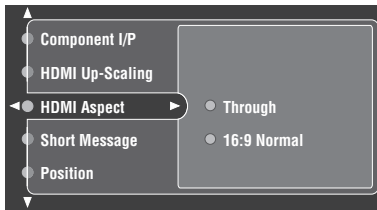

- Select “Through” if you do not make any adjustments to the HDMI aspect ratio.
- Select “16:9 Normal” if you want to display video images with 4:3 of HDMI aspect ratio on your video monitor with 16:9 of HDMI aspect ratio. Black stripes appear on the right and left sides as a result.

### Note

When HDMI Up-Scaling is set to Through (see page 88), you cannot make any adjustments to HDMI Aspect.

## ■ Short Message (Short message)

Use to select whether to display short messages regarding system operations on your video monitor.

Choices: Off, **On**

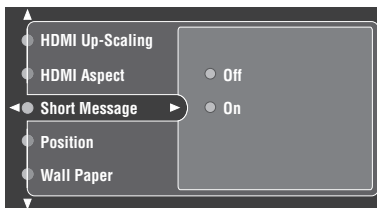

- Select “Off” if you do not want to display any short messages.
- Select “On” if you want to display short messages.

### Notes

- The short message display may not display properly depending on the type of input signal and video monitor used.
- If Conversion is set to Off, the short message display is not displayed even if On is selected.

## ■ Position (Position)

Use to adjust the vertical and horizontal position of the GUI display.

Control range: -5 (downward/left) to +5 (upward/right)

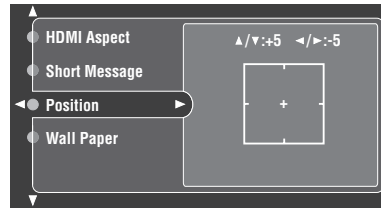

- Press  $\Delta$  to raise the position of the GUI display.
- Press  $\nabla$  to lower the position of the GUI display.
- Press  $\triangleright$  to shift the position of the GUI display to the right.
- Press  $\triangleleft$  to shift the position of the GUI display to the left.

## ■ Wall Paper (Wall paper)

Use to select the background of the GUI display.

Choices: None, **Yes**, Gray

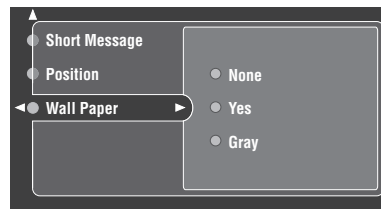

- Select “None” not to display any background in the GUI display.
- Select “Yes” to display a background image in the GUI display.
- Select “Gray” to display a gray background in the GUI display.

### Note

If Video Conv. is set to “Off”, no background is displayed even if “Yes” is selected.

## Manual Setup (Basic)

Use this menu to set up basic system parameters.

- 1 Set AMP/SOURCE/TV to AMP and then press GUI TOP on the remote control.

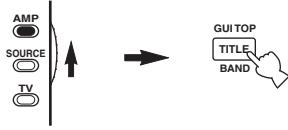

- 2 Press  $\Delta$  /  $\nabla$  on the remote control to select Manual Setup and then press  $\triangleright$ .

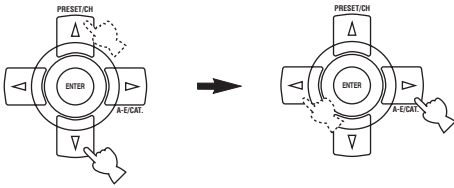

- 3 Press  $\Delta$  /  $\nabla$  on the remote control to select Basic and then press  $\triangleright$ .

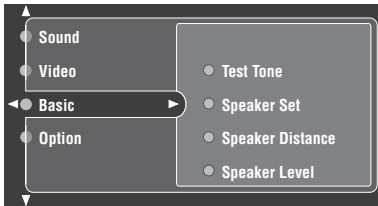
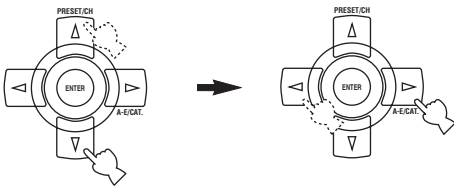

- 4 Select the desired parameters and then press  $\triangleright$  to access and adjust.

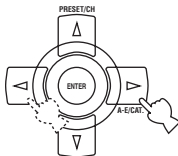

- Most of the parameters described in the basic menu are set automatically when you run AUTO SETUP. You can use the basic menu to make further adjustments, but we recommend running AUTO SETUP first.
- You can reset these parameters by performing the AUTO SETUP procedure (see page 32).

### Test Tone (Test tone)

Turns the test tone output on or off for Speaker Set, Speaker Distance and Speaker Level settings.

Manual Setup > Basic > Test Tone >

Choices: Off, On

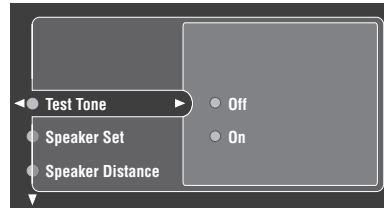

If you use a handheld SPL meter, hold at arms length and point upwards so that the meter is in the listening position. With the meter set to the 70 dB scale and to C SLOW, calibrate each speaker to 75 dB.

#### Note

Loud test tones will be output when "On" is selected. In this case, make sure no children are present in the listening room.

### Speaker Set (Speaker set)

Use to manually adjust any speaker setting.

Manual Setup > Basic > Speaker Set >

Choices: Front, Center, Surround, Surround Back, Presence, Bass Out, Bass Cross Over, SWFR Phase

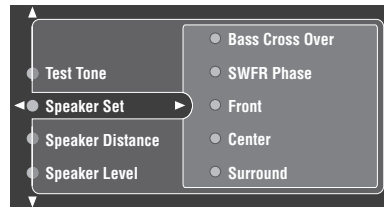

If you are not satisfied with the bass sounds from your speakers, you can change these settings according to your preference.

#### Note

Set any THX speakers to Small.

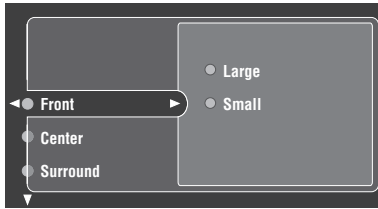
**Front (Front speakers)**Choices: Large, **Small**

- Select “Large” if you have large front speakers. The unit directs the entire range of the front left and right channel signals to the front left and right speakers.
- Select “Small” if you have small front speakers. The unit directs the low-frequency signals of the front channel to the speakers selected with Bass Out.

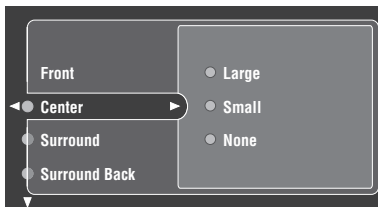
**Center (Center speaker)**Choices: Large, **Small**, None

- Select “Large” if you have a large center speaker. The unit directs the entire range of the center channel signal to the center speaker.
- Select “Small” if you have a small center speaker. The unit directs the low-frequency signals of the center channel to the speakers selected with Bass Out.
- Select “None” if you do not have a center speaker. The unit directs all of the center channel signal to the front left and right speakers.

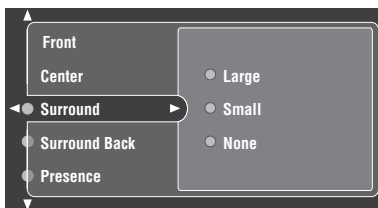
**Surround (Surround left/right speakers)**Choices: Large, **Small**, None

- Select “Large” if you have large surround left and right speakers or if a rear subwoofer is connected to the surround speakers. The entire range of the surround channel signal is directed to the surround left and right speakers.
- Select “Small” if you have small surround left and right speakers. The low-frequency signals of the surround channel are directed to the speakers selected with Bass Out.
- Select “None” if you do not have surround speakers. This sets the unit to the Virtual CINEMA DSP mode (see page 44) and automatically sets the surround back speaker setting (Surround Back) to “None”.

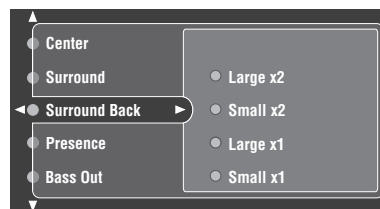
**Surround Back (Surround back left/right speakers)**Choices: Large x2, **Small x2**, Large x1, Small x1, None

- Select “Large x2” if you have two large surround back speakers. The unit directs the entire range of the surround back channel signal to the surround back speakers.
- Select “Small x2” if you have two small surround back speakers. The low-frequency signals of the surround back channels are directed to the speakers selected with Bass Out.
- Select “Large x1” if you have a large surround back speaker. The unit directs the entire range of the surround back channel signal to the surround back left speaker.
- Select “Small x1” if you have a small surround back speaker. The low-frequency signals of the surround back channel are directed to the speakers selected with Bass Out, and the rest of the frequency signals are directed to the surround back left speaker.
- Select “None” if you do not have a surround back speaker. The unit directs all of the surround back channel signal to the surround left and right speakers.

**Notes**

- If you select “Large x1” or “Small x1”, connect a speaker to the SURROUND BACK (SINGLE) speaker terminals.
- NONE is automatically selected if BI-AMP is set to ON (see page 102). This affects settings for Speaker Level and Speaker Distance.

### Presence (Presence speakers)

Choices: **Yes**, None

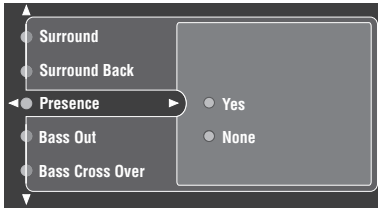

- Select “Yes” if you have presence speakers.
- Select “None” if you do not have presence speakers. This unit directs all presence channel signals to the front left and right speakers.

#### Note

- When Zone2 Amplifier is set to “INT:Sur.” or “INT:BOTH” (see page 96), Presence is automatically set to “None”.
- NONE is automatically selected if BI-AMP is set to ON (see page 102). This affects settings for Speaker Level and Speaker Distance.

### Bass Out (Bass out)

LFE signals carry low-frequency effects when this unit decodes Dolby Digital or DTS signals. These low-frequency signals can be directed to both front left and right speakers, and to the subwoofer (which can be used for both stereo reproduction and sound field programs).

Choices: Both, **SWFR**, Front  
THX recommendation: SWFR

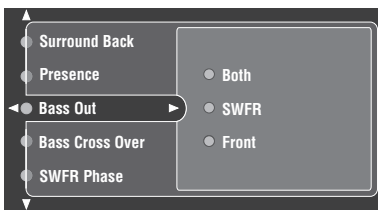

#### Notes

- Select “Both” to direct LFE signals to the subwoofer. Front L/R low-frequency signals are directed to both the subwoofer and front channels, and all other low-frequency signals are directed in accordance with other speaker settings.
- Select “SWFR” if you connected a subwoofer. The unit directs all LFE and low-frequency signals in accordance with other speaker settings.
- Select “Front” if you have not connected a subwoofer. The unit directs all low-frequency and LFE signals to the front speakers (even if you have previously set Front to Small in Speaker Set).

### Bass Cross Over (Bass cross over)

Use this feature to select a cross-over (cut-off) frequency for all low-frequency signals. All frequencies below the selected frequency are sent to the subwoofer.

Choices: 40Hz, 60Hz, **80Hz (THX)**, 90Hz, 100Hz, 110Hz, 120Hz, 160Hz, 200Hz

THX recommendation: 80Hz (THX)

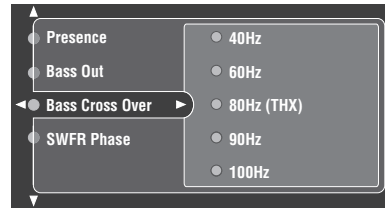

### SWFR Phase (Subwoofer Phase)

If bass sounds are lacking or unclear, use this feature to adjust the frequency phase characteristics of your subwoofer.

Choices: **Normal**, Reverse

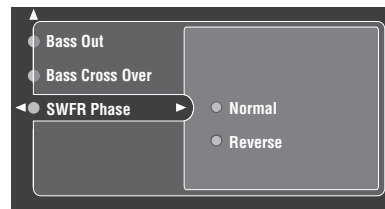

- Select “Normal” not to reverse the phase for your subwoofer(s).
- Select “Reverse” to reverse the phase for your subwoofer(s).

### Speaker Distance (Speaker distance)

Use this feature to manually input the distance of each speaker and adjust the delay applied to the respective channel. Ideally, each speaker should be the same distance from the main listening position. However, this is not possible in most home situations. Thus, a certain amount of delay must be applied to the sound from each speaker so that all sound will arrive at the listening position at the same time.

Manual Setup > Basic > Speaker Distance >

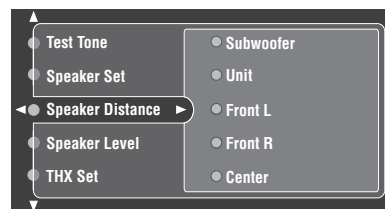



## Speaker distances

Control range: 0.30 to 24.00 m (1.0 to 80.0 ft)

Initial setting: 3.00 m (10.0 ft)

Control step: 0.1 m (0.5 ft)

- **Front L** adjusts the distance of the front left speaker.
- **Front R** adjusts the distance of the front right speaker.
- **Center** adjusts the distance of the center speaker.
- **Surround L** adjusts the distance of the surround left speaker.
- **Surround R** adjusts the distance of the surround right speaker.
- **Surround Back L** adjusts the distance of the surround back left speaker.
- **Surround Back R** adjusts the distance of the surround back right speaker.
- **Presence L** adjusts the distance of the presence left speaker.
- **Presence R** adjusts the distance of the presence right speaker.
- **Subwoofer** adjusts the distance of the subwoofer.

### Notes

- You cannot adjust the distance of speakers set to “None” in Speaker Set.
- If you are only using one surround back speaker, connect it to the SURROUND BACK (SINGLE) jack, and adjust the distance in Surround Back L.

## Unit (Unit)

Choices: **Meter** (m), Feet (ft)

Initial setting: Feet (U.S.A. and Canada models)

Meter (Other models)

- Select “Meter” to input speaker distances in meters.
- Select “Feet” to input speaker distances in feet.

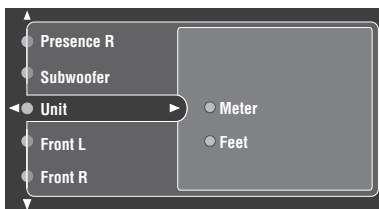

## Speaker Level (Speaker level)

Use these settings to manually balance the speaker levels between the front left speakers and each speaker selected in Speaker Set (see page 90).

Manual Setup > Basic > Speaker Level

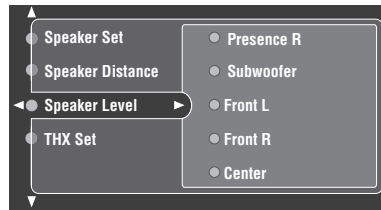

Control range: -10.0 dB to +10.0 dB

Initial setting: 0.0 dB

Control step: 0.5 dB

- **Front L** adjusts the balance of the front left speaker.
- **Front R** adjusts the balance of the front right speaker.
- **Center** adjusts the balance of the center speaker.
- **Surround L** adjusts the balance of the surround left speaker.
- **Surround R** adjusts the balance of the surround right speaker.
- **Surround Back L** adjusts the balance of the surround back left speaker.
- **Surround Back R** adjusts the balance of the surround back right speaker.
- **Presence L** adjusts the balance of the presence left speaker.
- **Presence R** adjusts the balance of the presence right speaker.
- **Subwoofer** adjusts the balance of the subwoofer.



To calibrate correctly to THX reference levels, use Test Tone (see page 90).

### Notes

- You cannot adjust the level of channels set to “None” in Speaker Set.
- If you are only using one surround back speaker, connect it to the SURROUND BACK (SINGLE) jack, and adjust the balance in Surround Back L.

**THX Set (THX settings)**

Use to manually adjust the THX settings.

Manual Setup > Basic > THX Set >



**SB Speaker Dist. (Surround back speaker distance)**

Use this feature to optimize the surround sound field when you have to place the surround back speakers apart.

Choices:

U.S.A. and Canada models: under 1ft, **1 – 4ft**, over 4ft

Other models: under 0.3m, **0.3 – 1.2m**, over 1.2m

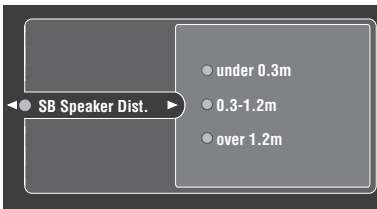

- Select “under 0.3m” or “under 1ft” if the distance between the two surround back speakers is less than 0.3 m (1 ft).
- Select “0.3 – 1.2m” or “1 – 4ft” if the distance between the two surround back speakers is between 0.3 and 1.2 m (1 and 4 ft).
- Select “over 1.2m” or “over 4ft” if the distance between the two surround back speakers is more than 1.2 m (4 ft).

**Manual Setup (Option)**

This menu adjusts the optional system settings.

**1 Set AMP/SOURCE/TV to AMP and then press GUI TOP on the remote control.**

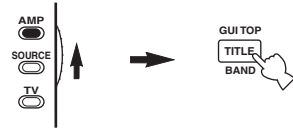

**2 Press Δ / ▽ on the remote control to select Manual Setup and then press ▷.**

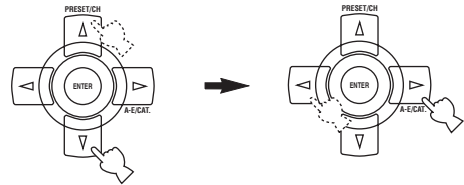

**3 Press Δ / ▽ on the remote control to select Option and then press ▷.**

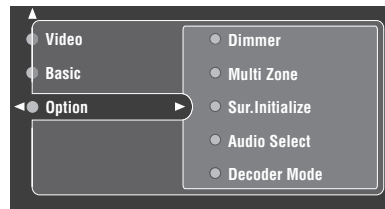
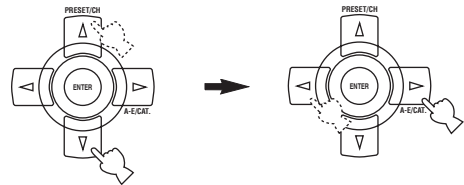

**4 Select the desired parameters and then press ▷ to access and adjust.**

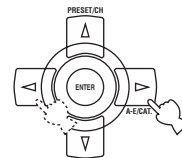

- 5** When finished adjusting parameters, press **ENTER** on the remote control.

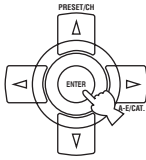

**■ Dimmer (Dimmer)**

Use to adjust the brightness of the front panel display.

Manual Setup > Option > Dimmer >

Control range: -4 to 0

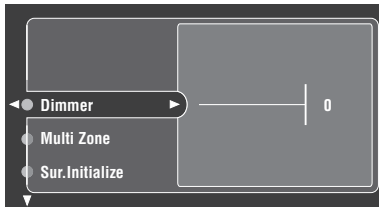

**■ Multi Zone (Multi zone)**

Use this feature to customize the Zone 2 and Zone 3 settings.

Manual Setup > Option > Multi Zone >

Choices: Speaker B, **Zone2 Amplifier**, Zone3 Amplifier, Zone2 Volume, Zone3 Volume, Zone2 OSD

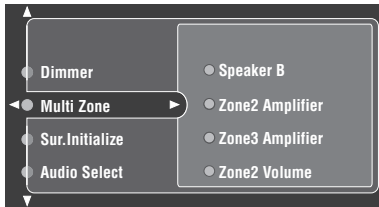

**Speaker B (Speaker B)**

Use this feature to select the location of the front speakers connected to the SPEAKERS B terminals.

Choices: **Main**, Zone B

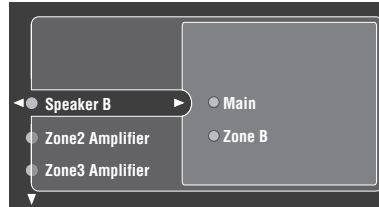

- Select “Main” to turn on/off SPEAKERS A and B when the speakers connected to the SPEAKERS B terminals are set in the main room.
- Select “Zone B” if the speakers connected to the SPEAKERS B terminals are set in another room. If SPEAKERS A is turned off and SPEAKERS B is turned on, all the speakers including the subwoofer in the main room are muted and the unit outputs sound from SPEAKERS B only.

**Notes**

- If you select “Zone B” and connect headphones to the PHONES jack on this unit, the sound is output from both the headphones and SPEAKERS B.
- When a DSP program is selected, the unit automatically enters the Virtual CINEMA DSP mode.

**Zone2 Amplifier (Zone 2 amplifier)**

Use to select how the Zone 2 speakers are amplified.

Choices: **EXT**, INT:Sur., INT:PRNS, INT:BOTH

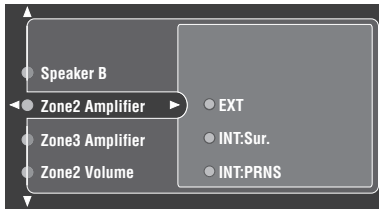

- Select “EXT” if you want to connect your Zone 2 speakers through an external amplifier connected to the ZONE 2 OUTPUT jacks on the rear panel of this unit.
- Select “INT:Sur.” to use the internal surround amplifier of this unit if you want to connect your Zone 2 speakers directly to the PRESENCE/ZONE 2(3) speaker terminals on the rear panel of this unit.
- Select “INT:PRNS” to use the internal surround back amplifier of this unit if you want to connect your Zone 2 speakers directly to the PRESENCE/ZONE 2(3) speaker terminals on the rear panel of this unit.
- Select “INT:BOTH” to use the internal surround and surround back amplifiers of this unit if you want to connect you Zone 2 speakers directly to both the PRESENCE/ZONE 2(3) and the SURROUND/ZONE 2(3) speaker terminals on the rear panel of this unit.

**Notes**

- If BI-AMP is set to ON in the ADVANCED SETUP menu (see page 102), there will be no audio output at the selected speaker terminals although INT:Sur., INT:PRNS and INT:BOTH can be selected in the GUI menu.
- Zone 2 and Zone 3 cannot use the same amplifier at the same time. If INT:BOTH is selected for Zone2 Amplifier, for instance, only EXT can be selected for Zone3 Amplifier and vice versa.
- The Intelligent Power AMP Assign feature of this unit becomes in effect in the following cases so that the surround and surround back amplifiers of this unit are automatically assigned to the main room for the use of the surround back speakers connected to the SURROUND BACK speaker terminals in the 7.1-channel system.
  - When Zone2 Amplifier and Zone3 Amplifier are set to INT:PRNS and EXT respectively and Zone 2 is turned off
  - When Zone2 Amplifier and Zone3 Amplifier are set to EXT and INT:PRNS respectively and Zone 3 is turned off
- If either Zone2 Amplifier or Zone3 Amplifier is set to INT:Sur. or INT:BOTH, Surround (see page 91), Surround Back (see page 91) and Presence (see page 92) in Speaker Set are all automatically set to None. As a result, the speaker system of the main room is limited to 3.1 or 2.1-channel playback no matter when Zone 2 or Zone 3 is turned off because the SURROUND/ZONE 2(3) speaker terminals are used for the zone connection.

**Zone3 Amplifier (Zone 3 amplifier)**

Use to select how the Zone 3 speakers are amplified.

Choices: **EXT**, INT:Sur., INT:PRNS, INT:BOTH

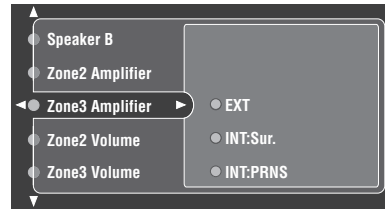

- Select “EXT” if you want to connect your Zone 3 speakers through an external amplifier connected to the ZONE 2 OUTPUT jacks on the rear panel of this unit.
- Select “INT:Sur.” to use the internal surround amplifier of this unit if you want to connect your Zone 3 speakers directly to the PRESENCE/ZONE 2(3) speaker terminals on the rear panel of this unit.
- Select “INT:PRNS” to use the internal surround back amplifier of this unit if you want to connect your Zone 3 speakers directly to the PRESENCE/ZONE 2(3) speaker terminals on the rear panel of this unit.
- Select “INT:BOTH” to use the internal surround and surround back amplifiers of this unit if you want to connect you Zone 3 speakers directly to both the PRESENCE/ZONE 2(3) and the SURROUND/ZONE 2(3) speaker terminals on the rear panel of this unit.

**Notes**

- If BI-AMP is set to ON in the ADVANCED SETUP menu (see page 102), there will be no audio output at the selected speaker terminals although INT:Sur., INT:PRNS and INT:BOTH can be selected in the GUI menu.
- Zone 2 and Zone 3 cannot use the same amplifier at the same time. If INT:BOTH is selected for Zone2 Amplifier, for instance, only EXT can be selected for Zone3 Amplifier and vice versa.
- The Intelligent Power AMP Assign feature of this unit becomes in effect in the following cases so that the surround and surround back amplifiers of this unit are automatically assigned to the main room for the use of the surround back speakers connected to the SURROUND BACK speaker terminals in the 7.1-channel system.
  - When Zone2 Amplifier and Zone3 Amplifier are set to INT:PRNS and EXT respectively and Zone 2 is turned off
  - When Zone2 Amplifier and Zone3 Amplifier are set to EXT and INT:PRNS respectively and Zone 3 is turned off
- If either Zone2 Amplifier or Zone3 Amplifier is set to INT:Sur. or INT:BOTH, Surround (see page 91), Surround Back (see page 91) and Presence (see page 92) in Speaker Set are all automatically set to None. As a result, the speaker system of the main room is limited to 3.1 or 2.1-channel playback no matter when Zone 2 or Zone 3 is turned off because the SURROUND/ZONE 2(3) speaker terminals are used for the zone connection.

### Zone2 Volume (Zone 2 volume)

Use to select how the volume control will operate with regard to the ZONE 2 OUTPUT jacks. When Zone2 Amplifier is set to “Internal”, this feature is automatically set to “Variable”.

Choices: Fixed, **Variable**

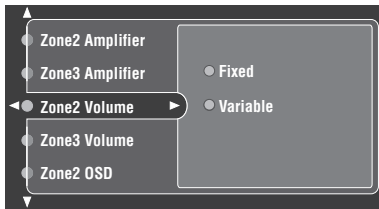

- Select “Fixed” to fix the ZONE 2 OUTPUT volume level to a standard line level.
- Select “Variable” to adjust the ZONE 2 OUTPUT volume simultaneously using VOL +/- on the remote control.

### Zone3 Volume (Zone 3 volume)

Use to select how the volume control will operate with regard to the ZONE 3 OUTPUT jacks.

Choices: Fixed, **Variable**

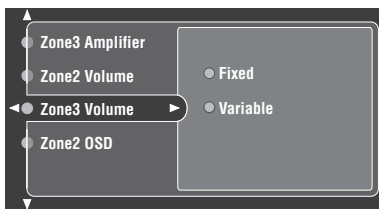

- Select “Fixed” to fix the ZONE 3 OUTPUT volume level to a standard line level.
- Select “Variable” to adjust the ZONE 3 OUTPUT volume simultaneously using VOL +/- on the remote control.

### Zone2 OSD (Zone 2 on-screen display)

Use this feature to display the operational status of Zone 2 as well as Zone 3 on the Zone 2 video monitor connected to the ZONE 2 VIDEO jacks on the rear panel of this unit. The Zone 2 and Zone 3 information to be displayed is listed as follows:

- The input source of Zone 2 and Zone 3
- The volume level of Zone 2 and Zone 3
- The audio mute status of Zone 2 and Zone 3
- The tonal quality status of Zone 2 and Zone 3
- The XM Satellite Radio information when XM is selected as the input source of Zone 2 and Zone 3

Choices: **Off**, Zone2, Zone2&Zone3

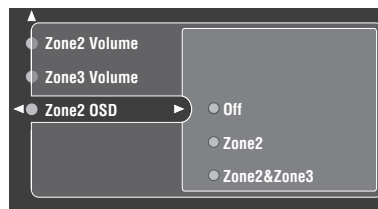

- Select “Off” not to display any operational status of Zone 2 and Zone 3 on the Zone 2 video monitor.
- Select “Zone2” to display the operational status of Zone 2 only on the Zone 2 video monitor.
- Select “Zone2&Zone3” to display the operational status of Zone 2 and Zone 3 on the Zone 2 video monitor.

### Notes

- If Zone2 OSD is set to Zone2&Zone3, changes to the operational status of Zone 3 is displayed on the Zone 2 video monitor. For example, if the input source of Zone 3 is changed while you are watching TV in Zone 2, the name of the changed input source of Zone 3 is displayed on your TV in Zone 2.
- If Zone2 OSD is set to Zone2&Zone3, the display contents of Zone 2 and Zone 3 depends on whether or not Zone 2 and Zone 3 are turned on with ZONE 2 ON/OFF and ZONE 3 ON/OFF on the front panel (see page 116).
  - If both Zone 2 and Zone 3 are turned on, the video signals of the current input source of Zone 2 and the corresponding OSD are displayed on the Zone 2 video monitor.
  - If Zone 2 is turned off and Zone 3 is turned on, only the corresponding OSD is displayed in the gray background regardless of the REC OUT/ZONE 2 status on the front panel.
  - If Zone 2 is turned on and Zone 3 is turned off, the video signals of the current input source of Zone 2 and the corresponding OSD are displayed on the Zone 2 video monitor.
  - If both Zone 2 and Zone 3 are turned off, no video signals and no OSD are displayed on the Zone 2 video monitor.

■ **Sur.Initialize (Surround initialize)**

Use this feature to initialize the parameters for each sound field program within sound field program groups. When you initialize a sound field program group, all of the parameter values within that group revert to their initial settings.

Adjusted sound field parameter settings are displayed in blue.

Manual Setup > Option > Sur.Initialize

Choices: **STEREO**, MUSIC, ENTERTAINMENT, MOVIE THEATER, SURROUND, All

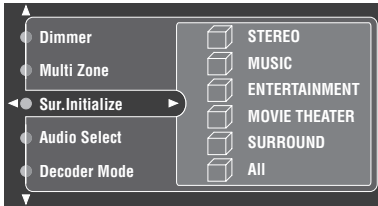

- Press  $\Delta$  /  $\nabla$  to select the sound field program you want to initialize and then press ENTER.
- Select "All" to initialize settings for all sound field program parameters.

**Note**

Sound field program groups cannot be initialized when Memory Guard is set to "On" (see page 98).

■ **Audio Select (Audio selection)**

Use this feature to designate the default input mode this unit selects when the power is turned on and the input source (such as a DVD player) is connected to the DIGITAL INPUT jacks on this unit.

Manual Setup > Option > Audio Select

Choices: **Auto**, Last

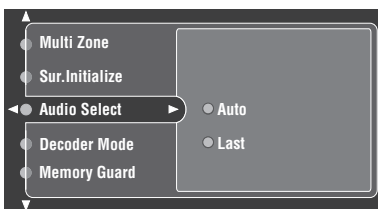

- Select "Auto" if you want this unit to automatically detect input signal types and select the appropriate input mode.
- Select "Last" if you want this unit to automatically select the last input mode used for the connected source.

**Note**

Selecting "Last" does not recall the last setting for the EXTENDED SURROUND button.

■ **Decoder Mode (Decoder mode)**

You can select the decoder used by this unit.

Manual Setup > Option > Decoder Mode

Choices: **Auto**, Last

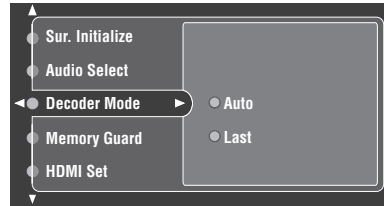

- Select "Auto" if you want this unit to automatically detect input signal types and select the appropriate decoder.
- Select "Last" if you want this unit to automatically select the last decoder used for the connected source.

■ **Memory Guard (Memory Guard)**

Use this feature to prevent accidental changes to DSP program parameter values and other system settings.

Manual Setup > Option > Memory Guard

Choices: **Off**, On

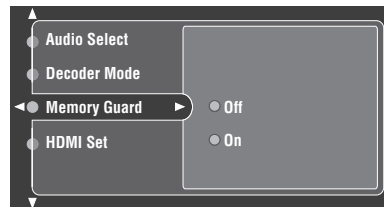

Select "On" to protect:

- DSP program parameters
- All menu items except Memory Guard and System Memory – Load.

**Note**

In general, front panel and remote control operations are not affected when Memory Guard is set to "On". However, you cannot adjust the tone control using Tone Control.

## ■ HDMI Set (HDMI settings)

Use to adjust the HDMI support audio.

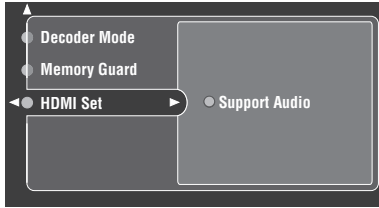

### Support Audio (Support audio)

Use to select whether to play back HDMI audio signals on this unit or on another HDMI component connected to the HDMI OUT jack on the rear panel of this unit.

Choices: **RX-V2600**, Other

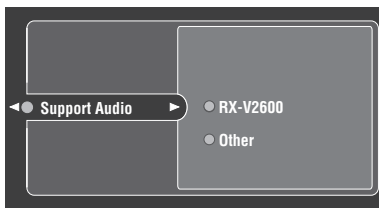

- Select “RX-V2600” to play back HDMI audio signals on this unit. The HDMI audio signals input at the HDMI IN jacks of this unit are not output to the HDMI component connected to the HDMI OUT jack on the rear panel of this unit.
- Select “Other” to play back HDMI audio signals on another HDMI component connected to the HDMI OUT jack on the rear panel of this unit.

#### Note

The HDMI video signals input at the HDMI IN 1 or HDMI IN 2 jack of this unit are always output at the HDMI OUT jack of this unit.

## System Memory

This feature allows you to save up to six of your favorite settings that can be easily recalled when needed. You can save settings such as the following:

- Sound field program parameters
- Speaker settings
- Speaker channel settings
- LFE level
- Dynamic range settings
- Parametric equalizer settings

### ■ To save settings

- 1 **Set AMP/SOURCE/TV to AMP and then press GUI TOP on the remote control.**

The top display appears.

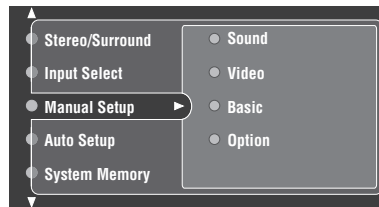

- 2 **Press  $\Delta$  /  $\nabla$  on the remote control repeatedly to select System Memory and then press  $\triangleright$ .**

- 3 **Select Save and then press ENTER.**

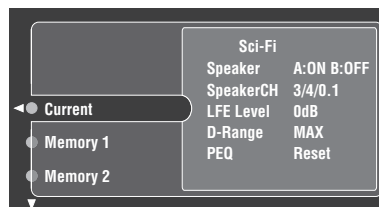

Current displays the current settings of this unit.

- 4 **Press  $\Delta$  /  $\nabla$  on the remote control repeatedly to select the memory number under which you want to save settings and then press  $\triangleright$ .** “Save: ENTER” appears in the bottom right corner of the window.

- 5 **Press ENTER to save settings.**

■ To load settings

- 1 Set AMP/SOURCE/TV to AMP and then press GUI TOP on the remote control.

The top display appears.

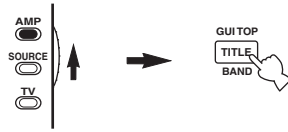

- 2 Press  $\Delta$  /  $\nabla$  on the remote control repeatedly to select System Memory and then press  $\triangleright$ .

- 3 Select Load and then press ENTER.

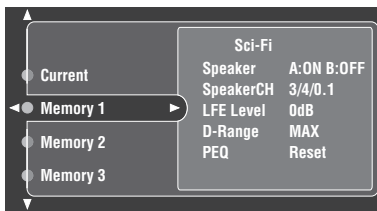

- 4 Press  $\Delta$  /  $\nabla$  on the remote control repeatedly to select the memory number you want to load and then press  $\triangleright$ .

“Load: ENTER” appears in the bottom right corner of the window.

- 5 Press ENTER to load settings.



Memory 1 and Memory 2 settings can be recalled simply by pressing MEMORY 1/2 on the remote control. When you press MEMORY 1, “Load Memory 1? Yes:Press Again” appears in the GUI and “Press MEMORY 1!” appears in the front panel display. Press MEMORY 1 once more to recall the settings.

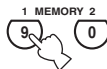

When you press MEMORY 2, “Load Memory 2? Yes:Press Again” appears in the GUI and “Press MEMORY 2!” appears in the front panel display. Press MEMORY 2 once more to recall the settings.

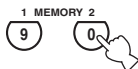

## Language

This feature allows you to select the language of your choice that appears in the GUI (graphical user interface) menu of this unit.

Choices: English (English), 日本語 (Japanese), Français (French), Deutsch (German), Español (Spanish)



You can also select the GUI language using the LANG. parameter in ADVANCED SETUP in the front panel display (see page 102).

- 1 Set AMP/SOURCE/TV to AMP and then press GUI TOP on the remote control.

The top display appears.

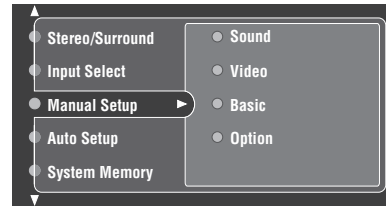
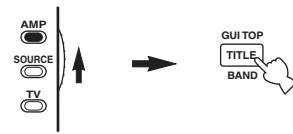

- 2 Press  $\Delta$  /  $\nabla$  on the remote control repeatedly to select Language and then press  $\triangleright$ .



- 3 Press  $\Delta$  /  $\nabla$  on the remote control repeatedly to select the language of your choice.

- 4 Press ENTER to confirm your selection.



# ADVANCED SETUP

This unit has additional menus that are displayed in the front panel display. The ADVANCED SETUP menu offers additional operations to adjust and customize the way this unit operates. Change the initial settings (indicated in bold under each parameter) to reflect the needs of your listening environment.

## Using ADVANCED SETUP

- 1 Press **MASTER ON/OFF** on the front panel to release it outward to the **OFF** position to set this unit, Zone 2 and Zone 3 to the standby mode.



- 2 Press and hold **STRAIGHT (EFFECT)** on the front panel and then press **MASTER ON/OFF** inward to the **ON** position to turn on the power of this unit.



- 3 Rotate the **PROGRAM** selector on the front panel to select the parameter you want to adjust.

The name of the selected parameter appears in the front panel display. See page 101 and 102 for a complete list of available parameters.

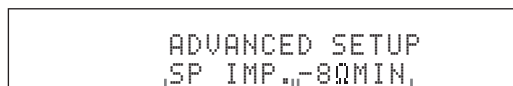

Name of the selected parameter      Current setting

- 4 Press **STRAIGHT (EFFECT)** on the front panel repeatedly to change the setting.



- 5 Press **MASTER ON/OFF** on the front panel to release it outward to the **OFF** position to save the new setting and set this unit, Zone 2 and Zone 3 to the standby mode.



The new setting is activated next time you press **MASTER ON/OFF** inward to the **ON** position to turn on the power of this unit, Zone 2 and Zone 3.

### Notes

- The control buttons on the remote control and **VOLUME** as well as the other control buttons on the front panel except **MASTER ON/OFF**, **STRAIGHT (EFFECT)** and the **PROGRAM** selector are ineffective while you are using the **ADVANCED SETUP** menu.
- Zone 2, Zone 3 and the speaker relay are all turned off and all audio and video output is muted while you are using the **ADVANCED SETUP** menu.
- The **ADVANCED SETUP** menu is only available in the front panel display.

### ■ Speaker impedance **SP IMP.**

Use to set the impedance of this unit so that it matches that of your speakers.

Choices: **6ΩMIN**, **8ΩMIN**

- Select **6ΩMIN** for speakers with 6 ohms or higher.
- Select **8ΩMIN** for speakers with 8 ohms or higher.

### ■ User preset **PRESET**

Use to reset all the parameters of this unit to the initial factory settings with the exception of System Memory and **AUTO SETUP** settings.

Choices: **CANCEL**, **RESET**

- Select **CANCEL** if you do not want to reset the parameters of this unit.
- Select **RESET** to reset the parameters of this unit.

### Notes

- This setting does not affect the **ADVANCED SETUP** menu item parameters.
- The initial factory settings are activated next time you turn on the power of this unit.

### ■ Remote sensor REMOTE SEN

Use to activate or deactivate the signal-receiving capability of the remote control sensor on the front panel of this unit.

Choices: **ON**, OFF

- Select ON if you want to activate the signal-receiving capability of the remote control sensor.
- Select OFF if you want to deactivate the signal-receiving capability of the remote control sensor.

#### Note

We recommend setting this parameter to ON in most cases.

### ■ Wake on RS-232C access WAKE ON 232C

Use to set this unit to transmit data via the RS-232C interface when this unit is in the standby mode.

Choices: **Y** (yes), N (no)

- Select Y set this unit to transmit data via the RS-232C interface.
- Select N set this unit not to transmit data via the RS-232C interface.

### ■ Remote control AMP ID REMOTE AMP

Use to set the AMP ID of this unit for remote control recognition (see page 106).

Choices: **ID1**, ID2

- Select ID1 when the remote control AMP library code is set to 2001.
- Select ID2 when the remote control AMP library code is set to 2002.

#### Note

You need to set the corresponding remote control code for the remote control.

### ■ Remote control tuner ID REMOTE TUN

Use to set the tuner ID of this unit for remote control recognition (see page 106).

Choices: **ID1**, ID2

- Select ID1 when the remote control tuner library code is set to 2602.
- Select ID2 when the remote control tuner library code is set to 2603.

#### Note

You need to set the corresponding remote control code for the remote control.

### ■ Remote control XM ID REMOTE XM (U.S.A. model only)

Use to switch the XM-related remote control codes between ID1 and ID2.

Choices: **ID1**, ID2

- Select ID1 when the remote control XM library code is set to 2604.
- Select ID2 when the remote control XM library code is set to 2605.

#### Note

You need to set the corresponding remote control code for the remote control.

### ■ Fan operation mode FAN MODE

Use to set the operation of the cooling fan of this unit.

Choices: **AUTO**, CONT.

- Select AUTO to set the fan to operate automatically according to the temperature of this unit.
- Select CONT. to set the fan to operate continuously regardless of the temperature of this unit.

### ■ Tuner frequency step TU (Asia and General models only)

Use to set the tuner frequency step according to the frequency spacing in your area.

Choices: AM10/FM100, **AM9/FM50**

- Select AM10/FM100 for North, Central and South America.
- Select AM9/FM50 for all other areas.

### ■ Bi-AMP BI-AMP

Use to activate or deactivate the bi-AMP function.

Choices: ON, **OFF**

- Select ON if you want to activate the bi-AMP function.
- Select OFF if you want to deactivate the bi-AMP function.

#### Note

When BI-AMP is set to ON, the SURROUND BACK terminals cannot be used to connect surround back speakers in that the SURROUND BACK terminals are already used for the bi-AMP connection (see page 19).

### ■ Video reset V-RESET

Use to initialize the parameter settings for Dimmer in the Option menu (see page 95). This feature is useful if the SET MENU items are not displayed on your video monitor due to a technical error between the CMPNT I/P setting and the capability of your video monitor. That is, if your video monitor does not support the analog video signals with 480p of resolution, the SET MENU items may not be displayed on your video monitor when Component I/P is set to On (see page 88).

Choices: YES, **CANCEL**

#### Note

The parameter setting for Dimmer is not initialized (see page 95).

### ■ TV format TV FORMAT

Use to set the color encoding format of your television.

Choices: PAL, NTSC

Initial setting:

- NTSC (U.S.A., Canada, General and Korea models)
- PAL (other models)

#### Note

This parameter setting only affects the video monitor connected to the MONITOR OUT jacks and does not affect the Zone 2 video monitor connected to the ZONE 2 VIDEO jacks.

### ■ GUI language LANG.

Use to select the language of your choice that appears in the GUI (graphical user interface) menu of this unit.

Choices: **ENGLISH** (English), JAPANESE (Japanese), FRENCH (French), GERMAN (German), SPANISH (Spanish)

# REMOTE CONTROL FEATURES

In addition to controlling this unit, the remote control can also operate other audio and video components made by YAMAHA and other manufacturers. To control these other components, you must set up the remote control with the appropriate remote control codes. This remote control also has a learn feature which allows the remote to acquire functions from other remote controls equipped with an infrared remote control transmitter.

## Control area

### ■ Controlling this unit

The shaded areas below can be used to control this unit after setting AMP/SOURCE/TV to AMP to activate the AMP mode.

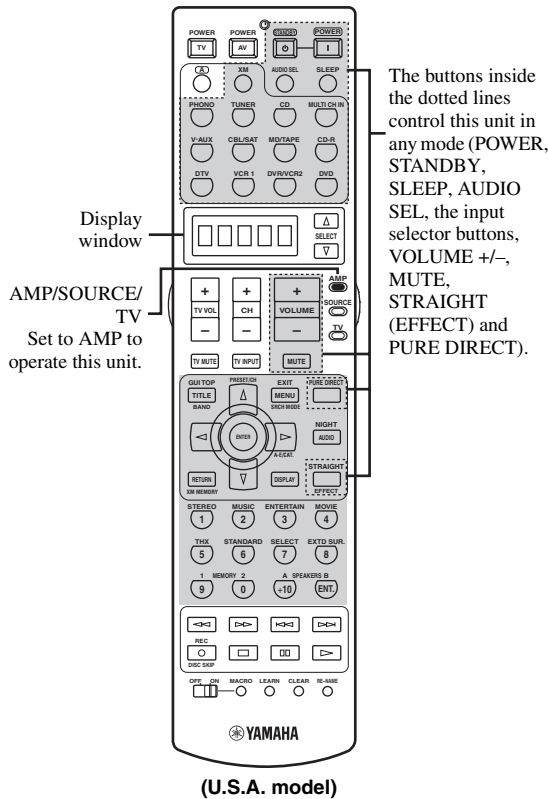

### ■ Controlling other components

The shaded areas below can be used to control other components. Each button has a different function depending on the selected components. Select the component you want to control by pressing an input selector button or SELECT  $\Delta$  /  $\nabla$ . The name of the selected component appears in the display window.

The A and input selector buttons switch the function of the component control area below.  
\* Use the A button to control other components regardless of whether they are connected to this unit.  
Factory setting: A...Tape deck

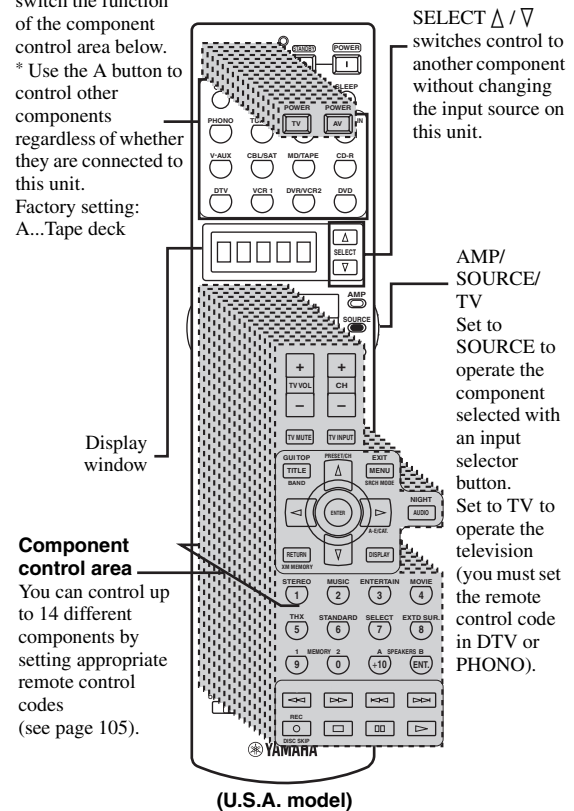

### ■ Controlling optional components (OPTN area)

OPTN is an additional component control area that can be programmed with remote control functions independently from any input source. This area is useful for programming commands that are to be used only as a part of a macro function or for components that do not have a valid remote control code.

To select the OPTN control area, press  $\nabla$  repeatedly until OPTN appears in the display window.

#### Note

You cannot set a remote control code for this area. See page 107 to program buttons operated within this component control area.

## Controlling each component

Once you set the appropriate remote control codes, you can use this remote to control your other components. Note that some buttons may not correctly operate the selected component. Use the input selector buttons to select the component you want to operate. The remote control automatically switches to the appropriate control mode for that component.

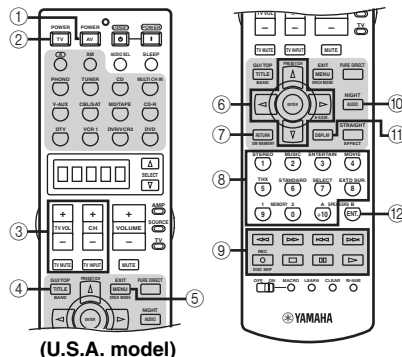

	DVD player/ DVD recorder	VCR	Cable TV/ Satellite tuner	TV	LD player	CD player	MD recorder/ CD recorder	Tape deck	Tuner
① AV POWER	Power *1	Power *1	Power *1	VCR power *3	Power *1	Power *1	Power *1	Power *1	Power *1
② TV POWER	TV power *2	TV power *2	TV power *2	Power *1	TV power *2	TV power *2	TV power *2	TV power *2	TV power *2
③ TV VOL +	TV volume + *2	TV volume + *2	TV volume + *2	Volume +	TV volume + *2	TV volume + *2	TV volume + *2	TV volume + *2	TV volume + *2
TV VOL -	TV volume - *2	TV volume - *2	TV volume - *2	Volume -	TV volume - *2	TV volume - *2	TV volume - *2	TV volume - *2	TV volume - *2
CH +	TV channel + *2	Channel +	Channel +	Channel +	TV channel + *2	TV channel + *2	TV channel + *2	TV channel + *2	TV channel + *2
CH -	TV channel - *2	Channel -	Channel -	Channel -	TV channel - *2	TV channel - *2	TV channel - *2	TV channel - *2	TV channel - *2
TV INPUT	TV input *2	TV input *2	TV input *2	Input	TV input *2	TV input *2	TV input *2	TV input *2	TV input *2
TV MUTE	TV mute *2	TV mute *2	TV mute *2	Mute	TV mute *2	TV mute *2	TV mute *2	TV mute *2	TV mute *2
④ TITLE	Title	Title	Title	Title					Band
⑤ MENU	Menu		Menu	Menu					
⑥ ENTER	Menu enter		Menu select	Menu select					
Δ	Menu up		Menu up	Menu up					Preset up (1 to 8)
∇	Menu down		Menu down	Menu down					Preset down (1 to 8)
◁	Menu left		Menu left	Menu left					Preset down (A to E)
▷	Menu right		Menu right	Menu right				Direction A/B	Preset up (A to E)
⑦ RETURN	Return	Return	Return	Return					
⑧ 1-9, 0, +10	Numeric buttons	Numeric buttons	Numeric buttons	Numeric buttons	Numeric buttons	Numeric buttons	Numeric buttons		
⑨ ◀◀	Search backward	Search backward	VCR search backward *3	VCR search backward *3	Search backward	Search backward	Search backward	Search backward	
▶▶	Search forward	Search forward	VCR search forward *3	VCR search forward *3	Search forward	Search forward	Search forward	Search forward	
⏮	Skip backward				Chapter/Skip backward	Skip backward	Skip backward	Direction back	
⏭	Skip forward				Chapter/Skip forward	Skip forward	Skip forward	Direction forward	
REC/ DISC SKIP	Disc skip (player) Rec (recorder)	Rec	VCR rec *3	VCR rec *3		Disc skip	Rec	Rec	
□	Stop	Stop	VCR stop *3	VCR stop *3	Stop	Stop	Stop	Stop	
⏸	Pause	Pause	VCR pause *3	VCR pause *3	Pause	Pause	Pause	Pause	
▶	Play	Play	VCR play *3	VCR play *3	Play	Play	Play	Play	
⑩ AUDIO	Audio				Audio				
⑪ DISPLAY	Display		Display	Display	Display	Display	Display		
⑫ ENTER		Enter	Enter/recall	Enter/ numeric button					

\*1 This button functions only when the original remote control of the component has a POWER button.

\*2 These buttons can operate your TV without switching the input if the remote control code is set in DTV or PHONO.

When the remote control code for your TV is set up in both the DTV and PHONO areas, priority is given to the signal in the DTV area.

\*3 These buttons can operate your VCR without switching the input to VCR 1 if the remote control code is set in VCR 1.

## Setting remote control codes

You can control other components by setting the appropriate remote control codes. Codes can be set up for each input area. For a complete list of available remote control codes, refer to “LIST OF REMOTE CONTROL CODES” at the end of this manual.

The following table shows the default component (Library: component category) and the remote control code for each input area.

### Remote control code default settings

Input area	Library (component category)	Default YAMAHA code
A	TAPE	2700
XM	TUNER	2604
PHONO	TV	–
TUNER	TUNER	2602
CD	CD	2300
MULTI CH INPUT	DVD	2102
V-AUX	VCR	–
CBL/SAT	CABLE	–
MD/TAPE	MD	2500
CD-R	CD-R	2400
DTV	TV	–
VCR 1	VCR	–
DVR/VCR2	DVR	2807
DVD	DVD	2102

#### Note

You may not be able to operate your YAMAHA component even if a YAMAHA remote control code is preset as listed above. In this case, try setting another YAMAHA remote control code.

### 1 Set AMP/SOURCE/TV to SOURCE.



### 2 Press an input selector button to select the source component you want to set up.

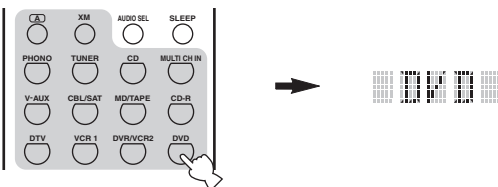

### 3 Press and hold LEARN for about 3 seconds using a ballpoint pen or similar object.

The library name (ex. L;DVD) and the selected component name (ex. DVD) appear alternately in the display window.

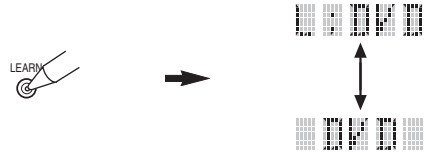

If you want to setup for another component, press the input selector button or SELECT  $\Delta$  /  $\nabla$  to select the component.

#### Notes

- Be sure to press and hold LEARN for at least 3 seconds, otherwise the learning process will start.
- If you do not complete each of the following steps within 30 seconds, the setting mode will be automatically canceled. In this case, press LEARN again.

### 4 If you want to change a library (component category), press $\triangleleft$ / $\triangleright$ . You can set a different type of component.

Library choices: L;DVD, L;DVR, L;LD, L;CD, L;CDR, L;MD, L;TAP (tape), L;TUN (tuner), L;AMP, L;TV, L;CAB (cable), L;SAT (satellite), L;VCR

#### Notes

- The tuner library (L;TUN) code is preset in the TUNER and XM buttons in order to operate this unit. The initial settings for the TUNER and XM buttons are 2602 and 2604 respectively. However, you can switch the tuner library code by entering one of the following codes if necessary.
- The AMP library (L;AMP) code is preset to 2001 in order to operate this unit. However, you can switch the AMP library code by entering one of the following codes if necessary.

**Setting remote control AMP codes**

Select one of the following codes to set the remote control AMP code for the component you want to use. Set AMP/SOURCE/TV to AMP or SOURCE and then change the remote control code settings.

AMP library code (remote control setting)	Function	Remote control AMP ID (this unit's setting: see page 102)
2001 (initial setting)	To operate this unit using the default code. To operate Zone 2 or Zone 3 features (see page 115).	ID1 (initial setting)
2002	To operate this unit using an alternative code. To operate Zone 2 or Zone 3 features (see page 115).	ID2

**Notes**

- You need to set the corresponding remote control AMP ID (see page 102).
- When using multiple YAMAHA receivers/amplifiers, you may be able to operate the other components simultaneously with the default code setting. In this case, set one of the alternative codes to operate this unit separately.

**Setting remote control tuner codes**

Select one of the following codes to set the remote control tuner code for the component you want to use. Set AMP/SOURCE/TV to SOURCE and press TUNER on the remote control to select TUNER as the input source and then change the remote control code settings.

Tuner library code (remote control setting)	Function	Remote control tuner ID (this unit's setting: see page 102)
2602 (initial setting)	To operate this unit using the default code.	ID1 (initial setting)
2603	To operate this unit using an alternative code.	ID2

**Notes**

- You need to set the corresponding remote control tuner ID (see page 102).
- When using multiple YAMAHA receivers/amplifiers, you may be able to operate the other components simultaneously with the default code setting. In this case, set one of the alternative codes to operate this unit separately.

**Setting remote control XM codes**

Select one of the following codes to set the remote control XM code for the component you want to use. Set AMP/SOURCE/TV to SOURCE and press XM on the remote control to select XM as the input source and then change the remote control code settings.

XM library code (remote control setting)	Function	Remote control XM ID (this unit's setting: see page 102)
2604 (initial setting)	To operate this unit using the default code.	ID1 (initial setting)
2605	To operate this unit using an alternative code.	ID2

**Notes**

- You need to set the corresponding remote control XM ID (see page 102).
- When using multiple YAMAHA receivers/amplifiers, you may be able to operate the other components simultaneously with the default code setting. In this case, set one of the alternative codes to operate this unit separately.

**5 Press ENTER.**

The four-digit code set for the selected component appears in the display window.

**Note**

0000 appears in the display window if no code has been set.

**6 Press the numeric buttons to enter the four-digit remote control code for the component you want to use.**

For a complete list of available remote control codes, refer to "LIST OF REMOTE CONTROL CODES" at the end of this manual.

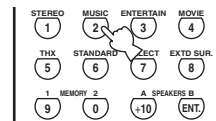

**7 Press ENTER to set the number.**

OK appears in the display window if setting was successful.

NG appears in the display window if the setting was unsuccessful. In this case, start over from step 3.



If you continuously want to set up another code for another component, press the input selector button or SELECT  $\Delta$  /  $\nabla$  to select the component and then repeat steps 4 through 6.

**8 Press LEARN again to exit from the setup mode.**



**9 Press one of the buttons shaded below to see if you can control your component. If you can, the remote control code is correct.**

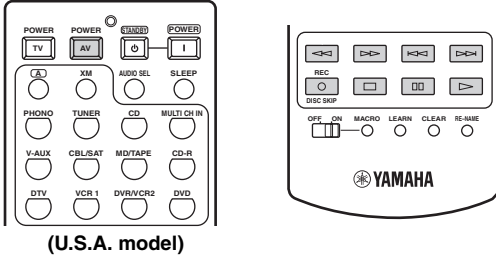

If the manufacturer of your component has more than one code, try each of them until you find the correct one.

**Notes**

- ERROR appears in the display window if you press a button not indicated in the respective step, or when you press more than one button simultaneously.
- The supplied remote control does not contain all possible codes for commercially available audio and video components (including YAMAHA components). If operation is not possible with any of the remote control codes, program the new remote control function using the Learn feature (see "Using LEARN") or use the remote control supplied with the component.
- Function programmed using the learn feature take priority over remote control code functions.

**Using LEARN**

You can program remote control codes from other remote controls. Use the LEARN feature if you want to program functions not included in the basic operations covered by the remote control codes, or an appropriate remote control code is not available. You can program any of the buttons available in the component control area (see page 103). The buttons can be programmed independently for each component.

**Note**

This remote control transmits infrared rays. If the other remote control also uses infrared rays, this remote control can learn most of its functions. However, you may not be able to program some special signals or extremely long transmissions. (Refer to the operating instructions for the other remote control.)

**1 Set AMP/SOURCE/TV to SOURCE.**

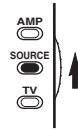

**2 Press an input selector button to select a source component.**

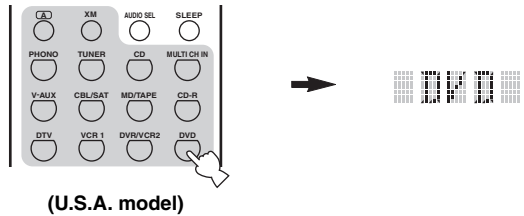

**3 Place this remote control about 5 to 10 cm (2 to 4 in) apart from the other remote control on a flat surface so that their infrared transmitters are aimed at each other.**

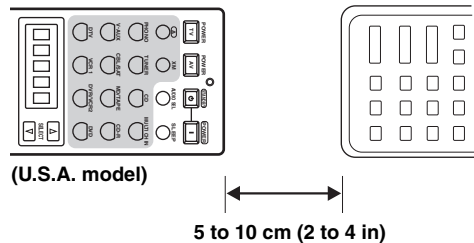

**4 Press LEARN using a ballpoint pen or similar object.**

LEARN and the selected component name (ex. DVD) appear alternately in the display window.

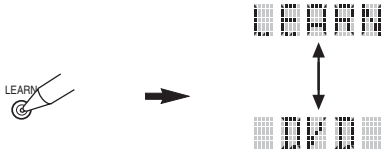

**Notes**

- Do not press and hold LEARN. If you hold it down for more than 3 seconds, the remote enters the remote control code setting mode.
- If you do not complete each of the following steps within 30 seconds, the learning mode will be automatically canceled. In this case, press LEARN again.

**5 Press the button for which you want to program the new function.**

LEARN appears in the display window.

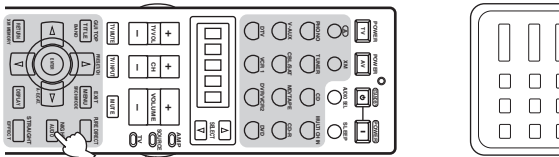

(U.S.A. model)

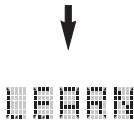

**6 Press and hold the button you want to program on the other remote control until OK appears in the display window.**

NG appears in the display window if learning was unsuccessful. In this case, start over from step 5.

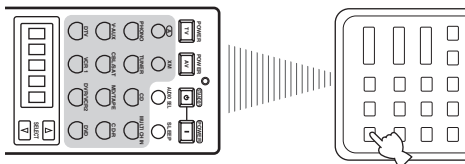

(U.S.A. model)



- If you want to program another function, repeat steps 5 and 6.
- If you continuously want to program another function for another component, press SELECT  $\Delta$  /  $\nabla$  to select the component and then repeat steps 5 and 6.

**7 Press LEARN again to exit the learning mode.**



**Notes**

- ERROR appears in the display window if you press a button not indicated in the respective step, or when you press more than one button simultaneously.
- This remote control can learn approximately 200 functions. However, depending on the signals learned, FULL may appear in the display before you program 200 functions. In this case, clear unnecessary programmed functions to make room for further learning.
- Learning may not be possible in the following cases:
  - When the batteries in the remote control for this unit or other components are weak.
  - When the distance between the two remote controls is too great or too small.
  - When the remote control infrared windows are not facing each other at the appropriate angle.
  - When the remote control is exposed to direct sunlight.
  - When the function to be programmed is continuous or uncommon.



## Using RE-NAME

You can change the name of the input source that appears in the display window on the remote control if you want to use a different name than the factory preset. This is useful when you have set the input selector to control a different component.

### 1 Set AMP/SOURCE/TV to AMP or SOURCE.

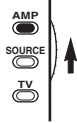

### 2 Press an input selector button to select the source component you want to rename.

The selected component name appears in the display window.

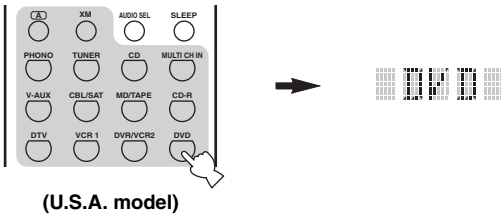

### 3 Press RE-NAME using a ballpoint pen or similar object.



#### Note

If you do not complete each of the following steps within 30 seconds, the renaming mode will be automatically canceled. In this case, press RE-NAME again.

### 4 Press $\Delta$ / $\nabla$ to select and enter a character.

Pressing  $\nabla$  changes the character as follows:  
 A to Z, 1 to 9, 0, + (plus), - (hyphen), ; (semicolon), / (slash), and space.  
 (Pressing  $\Delta$  changes the characters in reverse order.)

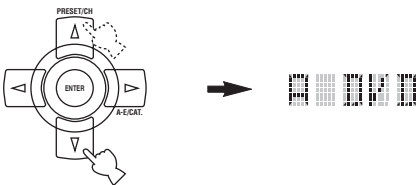

### 5 Press $\triangleleft$ / $\triangleright$ to move the cursor to the next position.

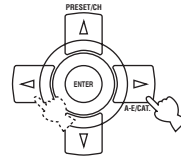

### 6 Press ENTER to set the new name.

OK appears in the display window if renaming was successful.

NG appears in the display window if renaming was unsuccessful. In this case, start over from step 4.



If you continuously want to rename another component, press the input selector button or SELECT  $\Delta$  /  $\nabla$  to select the component and then repeat steps 4 through 6.

### 7 Press RE-NAME again to exit the renaming mode.



#### Note

ERROR appears in the display window if you press a button not indicated in the respective step, or when you press more than one button simultaneously.

## Using MACRO

The MACRO feature makes it possible to perform a series of operations with the press of a single button. For example, when you want to play a CD, normally you would turn on the components, select the CD input, and press the play button to start playback. The MACRO feature lets you perform all of these operations simply by pressing the CD macro button. The buttons listed as macro buttons below are factory set with macro programs. You can also program your own macros (see page 111).

Press a macro button



To automatically transmit these signals in order



(CD area)

Macro buttons		First	Second	Third
			—	—
		(*1)	(*2)	—
		—	—	—
		—	—	—
				—
			(*3)	—
				(CD area) (*4)
				—
				—
				—
		(*1)		(MD/TAPE area) (*4)
				(CD-R area) (*4)
				—
				(VCR 1 area) (*4)
				(DVR/VCR 2 area) (*4)
				(DVD area) (*4)

\*1 You can turn on some components (including YAMAHA components) connected to this unit by connecting them to the AC OUTLETS on the rear panel of this unit. (Power control may not be synchronized with this unit depending on the component. For details, refer to the operating instructions for the connected component.)

\*2 When the remote control code for your TV is set up for either DTV or PHONO (see page 105), you can turn on the power of your TV without selecting an input source. The remote control code set up for DTV takes priority over the one for PHONO.

\*3 When TUNER is selected as the input source, this unit plays the last station received before the unit was set in the standby mode.

\*4 Playback can be started for any YAMAHA remote control-compatible MD recorder, CD player, CD recorder, DVD player, or DVD recorder. When using macros to operate other components, you will need to program the play button on the control area of that component (see page 107) or set a remote control code (see page 105).

■ **MACRO operations**

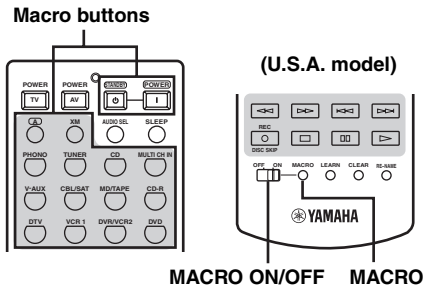

**1 Set MACRO ON/OFF to ON.**

**2 Press a macro button.**

**Notes**

- When you have finished using the MACRO feature, set MACRO ON/OFF to OFF.
- While the remote is carrying out a MACRO program, it will not accept any other button's function until the macro operation is complete (the transmission indicator stops flashing).
- Continue to aim the remote control at the component the macro is operating until the macro operation is complete.

■ **Programming MACRO operations**

You can program your own macro and use the MACRO feature to transmit several remote control commands in sequence at the press of a button. Be sure to set up remote control codes or perform learning operations before programming the macro. We do not recommend programming continuous operations such as volume control in a macro.

**Notes**

- The default macro is not cleared when a new macro is programmed for a button. The default macro can be used again when the programmed macro is cleared.
- It is not possible to add a new signal (macro step) to the default macro. Programming a macro changes all macro contents.

**1 Set AMP/SOURCE/TV to AMP or SOURCE.**

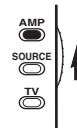

**2 Press MACRO using a ballpoint pen or similar object.**

“MCR ?” appears in the display window.



**Note**

If you do not complete each of the following steps within 30 seconds, the macro programming mode will be automatically canceled. In this case, press MACRO again.

**3 Press the macro button you want to use to operate the macro.**

The macro button name (ex. M;DVD) and the selected component name (ex. DVD) appear alternately in the display window.

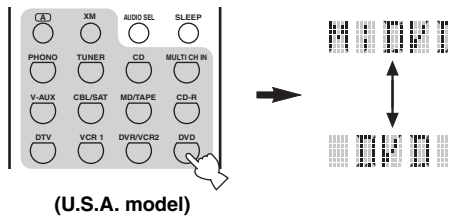

**Note**

AGAIN appears in the display window if you press a button other than a macro button.

**4 Press the buttons for the functions you want to include in the macro operation in sequence.**

You can set up to 10 steps (10 functions). After you have set 10 steps, FULL appears and the remote control automatically exits the macro mode.

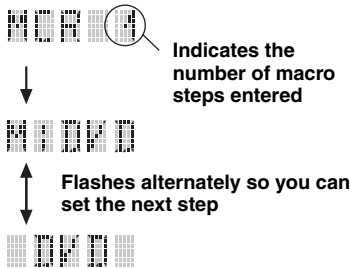
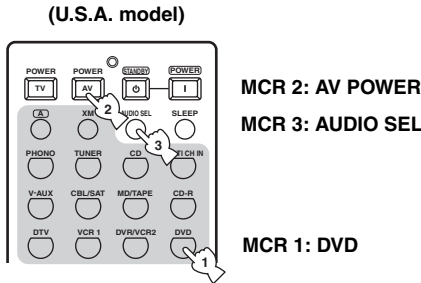

**Note**

To change the selected source component, press SELECT  $\Delta$  /  $\nabla$ . Pressing the input selector buttons will program a macro step, whereas SELECT  $\Delta$  /  $\nabla$  only changes the selected component and corresponding component control area.

**5 Press MACRO again when the operation sequence you want to program is complete.**

**Note**

ERROR appears in the display window if you press a button not indicated in the respective step, or if you press more than one button simultaneously.

**Memory back-up**

The memory back-up circuit prevents the stored data from being lost. However, the stored data will be lost in case the power cord is disconnected from the AC wall outlet for more than one week.

**Using CLEAR**

You can clear all changes made in each function set, such as learned functions, macros, renamed source names and setup remote control codes.

**Basic CLEAR operations**

**1 Set AMP/SOURCE/TV to AMP or SOURCE.**

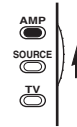

**2 Press CLEAR by using a ballpoint pen or similar object.**

CLEAR appears in the display window.



**Note**

If you do not complete each of the following steps within 30 seconds, the clearing mode will be automatically canceled. In this case, press CLEAR again.

**3 Press  $\Delta$  /  $\nabla$  to select the clear mode.**

- L;CD Clears all learned functions in the respective component control area. Press an input selector button to select the component.
- L;AMP Clears all learned functions for this unit's control area.
- L;ALL Clears all learned functions.
- M;ALL Clears all programmed macros.
- RNAME Clears all renamed source names.
- FCTRY Clears all remote functions and returns the remote to the factory settings.

**Note**

The name of a component is shown after a semicolon (;).

**4 Press and hold CLEAR again for about 3 seconds.**

WAIT appears in the display window. If clearing was successful, C;OK appears in the display window.



Once you have cleared a learned function for a button, the button reverts to the factory setting (or to the manufacturer setting, if you have set remote control codes).

**Note**

L;ALL and FCTRY may take about 30 seconds to complete.

**5 Release the object used to press CLEAR to exit from the clearing mode.**



**Notes**

- C;NG appears in the display window if clearing was unsuccessful. In this case start over from step 3.
- ERROR appears in the display window if you press a button not indicated in the respective step, or if you press more than one button simultaneously.

**■ Clearing a learned function**

You can clear the function learned for a certain button in each control area.

**1 Set AMP/SOURCE/TV to SOURCE.**

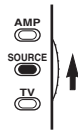

**2 Press an input selector button to select the source component containing the function you want to clear.**

The selected component name appears in the display window.

(U.S.A. model)

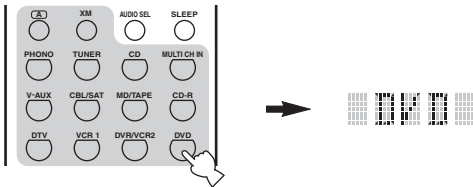

**3 Press LEARN using a ballpoint pen or similar object.**

LEARN and the selected component name (ex. DVD) appear alternately in the display window.

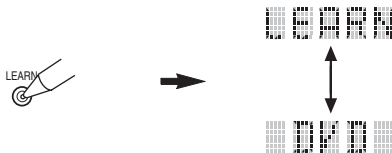

**Notes**

- Do not press and hold LEARN. If you hold it down for more than 3 seconds, the remote control enters the remote control code setting mode.
- If you do not complete each of the following steps within 30 seconds, the learning mode will be automatically canceled. In this case, press LEARN again.

**4 Press and hold CLEAR using a ballpoint pen or similar object and then press the button you want to clear for about 3 seconds.**

C;OK appears in the display window if clearing was successful.

(U.S.A. model)

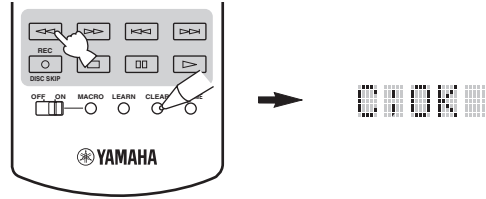

- If you continuously want to clear another function, repeat step 4.
- If you continuously want to clear another function for another component, press SELECT  $\Delta$  /  $\nabla$  to select the component and then repeat step 4.
- Once you clear a learned function, the button reverts to the factory setting (or to the manufacturer setting if you have set remote control codes).

**5 Release the object used to press CLEAR to exit the clearing mode.**

The remote control returns to the learning mode.

**6 Press LEARN again to exit.**

**Notes**

- C;NG appears in the display window if clearing was unsuccessful. In this case, start over from step 4.
- ERROR appears in the display window if you press a button not indicated in the respective step, or if you press more than one button simultaneously.

**■ Clearing a macro function**

You can clear the function programmed for a certain macro button.

**1 Set AMP/SOURCE/TV to AMP or SOURCE.**

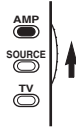

**2 Press MACRO using a ballpoint pen or similar object.**

“MCR ?” appears in the display window.



**Note**

If you do not complete each of the following steps within 30 seconds, the macro programming mode will be automatically canceled. In this case, press MACRO again.

**3 Press and hold CLEAR using a ballpoint pen or similar object and then press the macro button you want to clear for about 3 seconds.**

C;OK appears in the display window if clearing was successful.

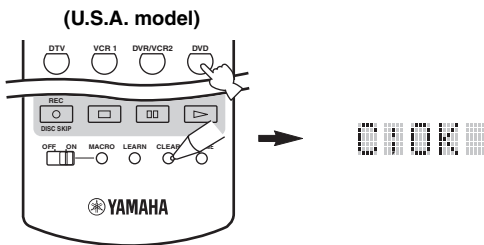

- If you continuously want to clear another function, repeat step 3.
- Once you clear a programmed function, the button reverts to the factory setting (or to the manufacturer setting if you have set remote control codes).

**4 Press CLEAR to exit the clearing mode.**

The remote control returns to the macro programming mode.

**5 Press MACRO again to exit.**

**Notes**

- C;NG appears in the display window if clearing was unsuccessful. In this case, start over from step 3.
- ERROR appears in the display window if you press a button not indicated in the respective step, or if you press more than one button simultaneously.

## ZONE 2/ZONE 3

This unit allows you to configure a multi-room audio system. The Zone 2 and Zone 3 features enable you to set this unit to reproduce separate input sources in the main room, second room (Zone 2) and third room (Zone 3). You can control this unit from the second or third room using the supplied remote control.

Only analog signals are sent to the second and third rooms. Any source you want to listen to in the second or third room must be connected using the analog (AUDIO L/R) input jacks on this unit.

### Connecting the Zone 2 and Zone 3 components

You need the following additional equipment to use the multi-room functions of this unit:

- An infrared signal receiver in the second and/or third room.
- An infrared emitter in the main room. This emitter transmits the infrared signals from the remote control in the second and/or third room to the main room (to a CD player or DVD player, for example).
- An amplifier and speakers for the second and/or third room.
- A video monitor for the second room.



- You do not need an extra amplifier and speakers for the second and/or third room if you want to use the internal amplifiers of this unit.
- Since there are many possible ways to connect and use this unit in a multi-room configuration, we recommend that you consult with your nearest authorized YAMAHA dealer or service center for the Zone 2 and Zone 3 connections that best meet your requirements.
- Some YAMAHA models are able to connect directly to the CONTROL OUT jack on this unit. If you own these products, you may not need to use an infrared emitter. Up to six YAMAHA components can be connected as shown.

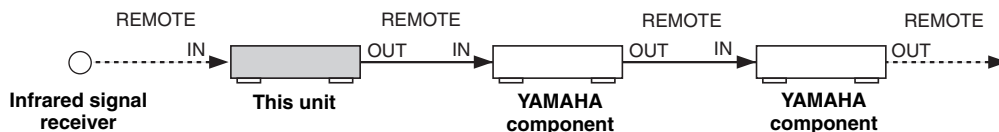

### Using the external amplifiers

To use an external amplifier in Zone 2, select EXT in Zone2 Amplifier (see page 96).

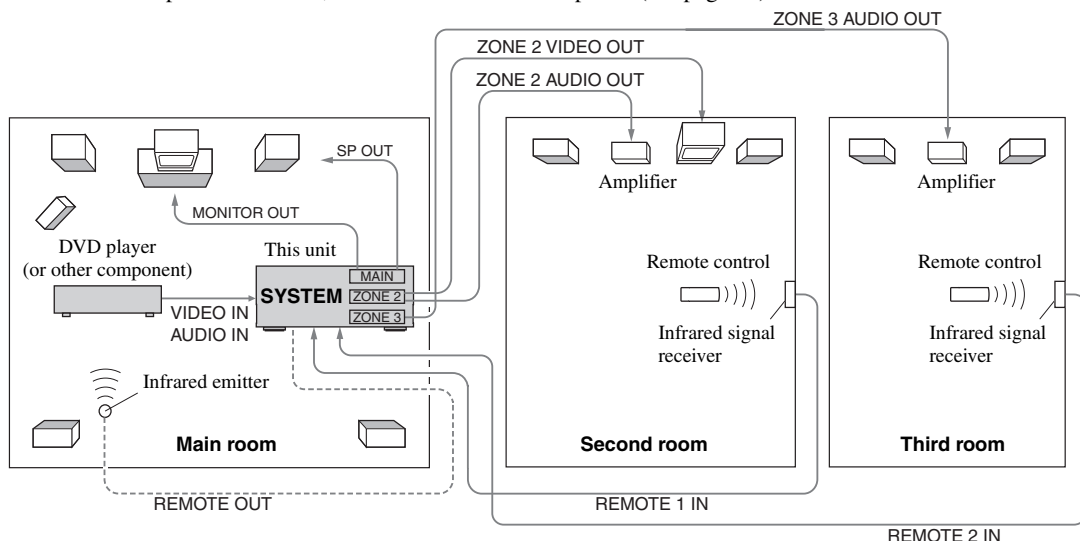

### Notes

- When not using the main room, turn down the volume of this unit in the main room. Adjust the Zone 2/Zone 3 volume by using the amplifier in the second/third room.
- To avoid unexpected noise, DO NOT USE the Zone 2/Zone 3 feature with CDs encoded in DTS.
- Only the analog video signals input at the composite VIDEO jacks on the rear panel of this unit are output at the ZONE 2 VIDEO OUT jacks. The analog video signals input at the S VIDEO and COMPONENT VIDEO jacks on the rear panel of this unit are not output at the ZONE 2 VIDEO OUT jacks.

■ **Using the internal amplifiers of this unit**

**If you want to use one internal amplifier (surround or surround back) of this unit**

Connect the Zone 2 or Zone 3 speakers directly to the SURROUND/ZONE 2(3) or PRESENCE/ZONE 2(3) terminals and select either INT:Sur. or INT:PRNS for Zone2 Amplifier (see page 96).

**If you want to use two internal amplifiers (both surround and surround back) of this unit**

Connect the Zone 2 or Zone 3 speakers directly to the SURROUND/ZONE 2(3) and PRESENCE/ZONE 2(3) terminals and select INT:BOTH for Zone2 Amplifier or Zone3 Amplifier (see page 96).

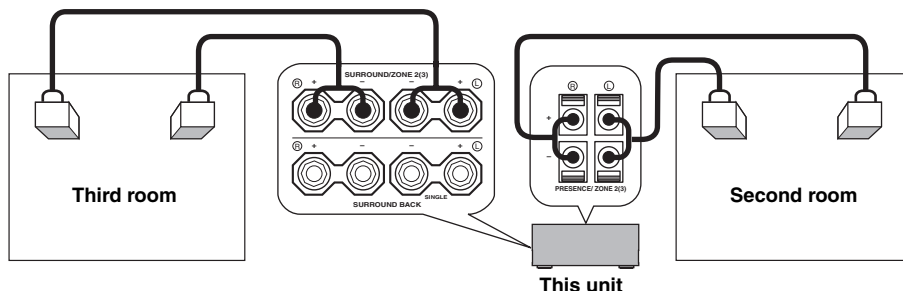

**IMPORTANT SAFETY NOTICE**

SURROUND/ZONE 2(3) or PRESENCE/ZONE 2(3) speaker terminals of this Receiver should not be connected to a Passive Loudspeaker Selector Box or more than one loudspeaker per channel. Connection to a Passive Loudspeaker Selector Box or multiple speakers per channel could create an abnormally low impedance load resulting in amplifier damage. See this owner’s manual for correct usage. Compliance with minimum speaker impedance information for all channels must be maintained at all times. This information is found on the back panel of your Receiver.

**Selecting Zone 2 or Zone 3**

You can select the zone you want to control by using the control buttons on the front panel or on the remote control. Once the zone you want to control is selected, you can control the selected zone as described in “Controlling Zone 2 and Zone 3” on page 117.

■ **Front panel operations**

- 1 Press MAIN ZONE ON/OFF, ZONE 2 ON/OFF or ZONE 3 ON/OFF on the front panel to individually turn on this unit, Zone 2 or Zone 3.**

Press each button repeatedly to turn on the respective zone or set it to the standby mode.



Once MASTER ON/OFF on the front panel is pressed inward to the ON position, you can also press POWER and STANDBY on the remote control to turn on this unit, Zone 2 and Zone 3 simultaneously.

- 2 Press ZONE CONTROL on the front panel repeatedly to select the zone you want to control.**



Each time you press ZONE CONTROL, the front panel display changes as shown below, and the indicator for the currently selected zone flashes for approximately 5 seconds. However, no indicator flashes when this unit is selected.



**No indicator flashes when this unit is selected.**

**ZONE2**

Controls the Zone 2 component connected to the ZONE 2 AUDIO L/R jacks on the rear panel of this unit.

**ZONE3**

Controls the Zone 3 component connected to the ZONE 3 AUDIO L/R jacks on the rear panel of this unit.





- You must complete this step within 5 seconds while the selected zone flashes in the front panel display. Otherwise, the currently selected zone mode is automatically canceled. In this case, press ZONE CONTROL again.
- The initial setting is ZONE2 when both Zone 2 and Zone 3 are turned on.

**3** Proceed to “Controlling Zone 2 and Zone 3” on page 117 for detailed information on the Zone 2 and Zone 3 control functions.

**Remote control operations**

**1** Set AMP/SOURCE/TV on the remote control to AMP.

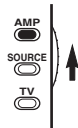

**2** Press SELECT  $\Delta$  repeatedly to select the zone you want to control.

ZONE 2 or ZONE 3 is displayed in the display window.

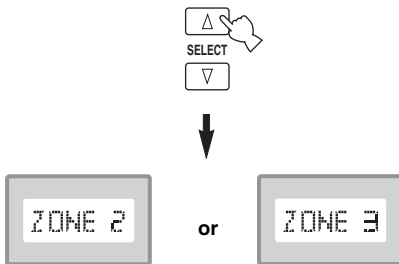

**3** Proceed to “Controlling Zone 2 and Zone 3” on page 117 for detailed information on the Zone 2 and Zone 3 control functions.

**4** Press SELECT  $\Delta$  /  $\nabla$  to exit from the Zone 2/Zone 3 mode.

**Notes**

- The input source of Zone 2 and the source available for recording are always the same.
- ZONE 2 or ZONE 3 appears in the display window only when  $\Delta$  is pressed, and ALL appears only when  $\nabla$  is pressed.

**Controlling Zone 2 and Zone 3**

Once the zone you want to control is selected as described in “Selecting Zone 2 or Zone 3” on page 116, you can control Zone 2 and Zone 3 by using the control buttons on the front panel or on the remote control. The available operations are listed as follows:

- Selecting the input source of Zone 2 or Zone 3
- Adjusting the volume level of Zone 2 or Zone 3
- Adjusting the tonal quality of Zone 2 or Zone 3
- Tuning into FM or AM when TUNER is selected as the input source of Zone 2 or Zone 3
- Tuning into the XM Satellite Radio when XM is selected as the input source of Zone 2 or Zone 3

**Selecting the input source of Zone 2 or Zone 3**

Use the INPUT selector on the front panel (or press one of the input selector buttons on the remote control) to select the input source of the selected zone.

If the remote control is used to select the input source, “2: name of the selected input source” or “3: name of the selected input source” is displayed in the display window when Zone 2 or Zone 3 is selected respectively.

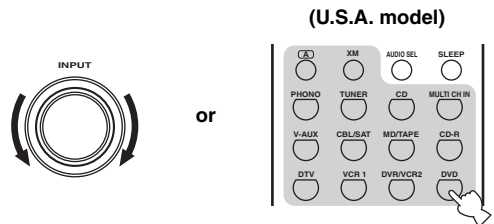

- Select TUNER as the input source to use the TUNER features in the selected zone. For details about the TUNER operations, see “FM/AM TUNING” on page 47.
- Select XM as the input source to use the XM Satellite Radio features in the selected zone. For details about the XM Satellite Radio operations, see “XM® SATELLITE RADIO TUNING” on page 53.

**Note**

The selected input source is shared across all zones.



You must complete this step within 5 seconds while the selected zone flashes in the front panel display. Otherwise, the currently selected zone mode is automatically canceled. In this case, press ZONE CONTROL on the front panel again.

### ■ Adjusting the volume level of Zone 2 or Zone 3

Rotate VOLUME on the front panel (or press VOLUME +/- on the remote control) to adjust the volume level of the selected zone.

Control range: -80 dB to +16.5 dB  
Control step: 0.5 dB

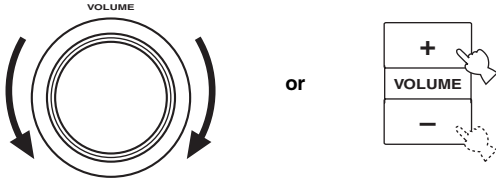

**Note**

VOLUME +/- can be used only when Zone2 Volume or Zone3 Volume is set to Variable in Multi Zone (see page 97).



Press MUTE to mute the sound output to the selected zone.

### ■ Adjusting the tonal quality of Zone 2 or Zone 3

Press CH +/- and TV VOL +/- on the remote control to adjust the high-frequency response (TREBLE) and the low-frequency response (BASS) respectively.

Control range: -10 dB to +10 dB  
Control step: 2 dB

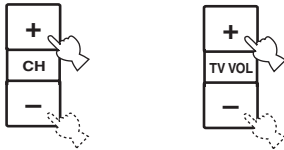

**Note**

Check that "ZONE 2" or "ZONE 3" is displayed in the display window of the remote control before you adjust the tonal quality of the corresponding zone (see page 117).



You can also adjust the tonal quality of Zone 2 or Zone 3 by using TONE CONTROL on the front panel. For details, see "Adjusting the tonal quality" on page 39.

### ■ Displaying the Zone 2 on-screen display

Use the Zone2 OSD parameter to display the operational status of Zone 2 as well as Zone 3 on the Zone 2 video monitor connected to the ZONE 2 VIDEO jacks on the rear panel of this unit. For detailed information on the Zone2 OSD parameter, see page 97.

## Using the control mode of Zone 2 and Zone 3

POWER and STANDBY on the remote control work differently depending on the selected zone that appears in the display window.

- When the normal, Zone 2 or Zone 3 mode is selected, you can turn on this unit, Zone 2 or Zone 3 or set them to the standby mode individually.
- When the all mode is selected, pressing POWER turns on this unit, Zone 2 and Zone 3 simultaneously and pressing STANDBY sets them to the standby mode simultaneously.

Control mode	LCD display	POWER and STANDBY
Normal mode	Name of component	Turns on the main unit only or sets it to the standby mode.
Zone 2 mode	"ZONE 2" or "2:name of the selected component"	Turns on Zone 2 or sets it to the standby mode.
Zone 3 mode	"ZONE 3" or "3:name of the selected component"	Turns on Zone 3 or sets it to the standby mode.
All mode	"ALL"	POWER: turns on the main unit, Zone 2 and Zone 3. STANDBY: sets the main unit, Zone 2 and Zone 3 to the standby mode.

**Note**

In the normal mode, MAIN appears for a few seconds when POWER or STANDBY is pressed.

# HDMI

## What is HDMI?

HDMI (High-Definition Multimedia Interface) is the first industry-supported, uncompressed, all-digital A/V (audio/video) interface.

Providing an interface between any A/V source (such as a set-top box or A/V receiver) and an audio/video monitor (such as a digital television – DTV), HDMI supports standard, enhanced or high-definition video as well as multi-channel digital audio using a single cable.

HDMI transmits all ATSC HDTV standards and supports 8-channel digital audio, with bandwidth to spare to accommodate future enhancements and requirements.

When used in combination with HDCP (High-bandwidth Digital Content Protection), HDMI provides a secure audio/video interface that meets the security requirements of content providers and system operators.

For further information on HDMI, visit the HDMI website at “<http://www.hdmi.org/>”.

This unit’s HDMI interface is based on the following standards:

- HDMI 1.1 (High-Definition Multimedia Interface Specification Version 1.1) licensed by HDMI Licensing, LLC.
- HDCP 1.1 (High-bandwidth Digital Content Protection System Revision 1.1) licensed by Digital Content Protection, LLC.

### Notes

- Analog audio signals input at the audio input jacks other than the HDMI IN 1 or HDMI IN 2 jack cannot be output at the HDMI OUT jack. However, analog video signals input at the composite video, S-video and component video jacks can be up-converted to HDMI so that the digitally up-converted video signals can be output at the HDMI OUT jack (see page 88).
- Connect the HDMI OUT jack of other components (such as a DVD player) to the HDMI IN 1 or HDMI IN 2 jack of this unit. Connect the HDMI OUT jack of this unit to the HDMI IN 1 or HDMI IN 2 jack of other components (such as a projector).
- You need a commercially available HDMI cable to connect this unit to other HDMI components. Use an HDMI cable shorter than 5 m (15 ft) to ensure stable operations and to prevent losses of video quality.
- This unit is not compatible with HDCP-incompatible HDMI or DVI components.
- Use a conversion cable (HDMI jack ↔ DVI-D jack) to connect this unit to other DVI components.
- Digital video signals input at the HDMI IN 1 or HDMI IN 2 jack cannot be output from analog video output jacks.

- Audio signals input at input jacks other than the HDMI IN 1 or HDMI IN 2 of this unit cannot be digitally output at the HDMI OUT jack.
- This unit is not compatible with multi-stereo area audio signals of Super Audio CDs. You can connect devices (such as a DVD player) to the MULTI CH INPUT jacks.
- When connected to a DVD player, audio signals may not be output depending on the type of the DVD player. In case the DVD player connected to this unit does not output DVD multi-channel audio signals at the HDMI OUT jack, connect the DVD player to the analog multi-channel audio input jacks.
- When CPPM copy-protected DVD audio plays back, video and audio signals may not be output depending on the type of the DVD player.
- Video and audio signals input at the HDMI IN 1 or HDMI IN 2 jack cannot be output at the HDMI OUT jack when this unit is set to the standby mode or the power is turned off.
- When connecting other HDMI components to this unit, refer to the instruction manuals for those components.
- When HDMI audio signals are output from components like a DVD player, the audio signal format (such as sampling frequencies) may be restricted depending on the HDMI video signal format.
- Do not disconnect or connect the HDMI cable from this unit or turn off the power of the HDMI/DVI components connected to the HDMI OUT jack of this unit while data is being transferred. Doing so may disrupt playback or cause noise.
- Some video monitors connected to this unit via a DVI connection fail to recognize the HDMI audio signals being input if they are in the standby mode. In this case, the HDMI indicator flashes irregularly and HDCP ERROR appears in the front panel display as if the DVI monitors do not support the HDCP copy protection standards.

### ■ HDMI compatibility with this unit

Audio signal types	Audio signal formats	Compatible HDMI components
2ch Linear PCM	2ch, 32-192 kHz, 16/20/24 bit	CD, DVD-Video, DVD-Audio, etc.
Multi-ch Linear PCM	5.1 ch, 32-96 kHz, 16/20/24 bit	DVD-Audio, etc.
Bitstream	Dolby Digital, DTS	DVD-Video, etc.

## Setting the HDMI parameters

### ■ Assigning HDMI components

You can assign an HDMI component to the HDMI IN 1 or HDMI IN 2 jack on the rear panel of this unit so that the audio and video signals input via HDMI connection can be simultaneously played back.

Use the I/O Assignment parameter in Input Select to assign HDMI components (see page 81).

### ■ Converting analog video signals to HDMI

This unit is equipped with the HDMI up-conversion feature where the analog video signals input at the composite video, S-video and component video jacks on the rear panel of this unit are digitally processed and up-converted so that they can be output at the HDMI OUT jack on the rear panel of this unit with all-digital resolution quality.

Use the HDMI Up-Scaling parameter in the Option menu to convert analog component video signals to HDMI (see page 88).

#### Note

When the analog video signals with 1080i or 720p of resolution are up-converted to HDMI and output at the HDMI OUT jack, the picture quality may worsen.

### ■ Setting the HDMI support audio

You can choose to play back HDMI audio signals on this unit or on another HDMI component connected to the HDMI OUT jack on the rear panel of this unit.

Use the HDMI Set parameter in the Option menu to set the HDMI support audio (see page 99).

## Basic HDMI operations

Perform the following steps to listen to playback from an registered HDMI component.

#### Note

If an error message appears in the front panel display, see page 127 for a complete list of error messages and proper remedies.

- 1 Rotate the INPUT selector on the front panel (or press one of the input selector buttons on the remote control) to select the input source assigned to the HDMI IN 1 or HDMI IN 2 jack on the rear panel of this unit.

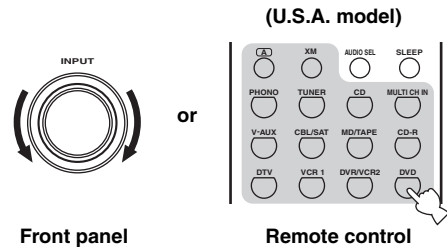

- 2 Press AUDIO SELECT on the front panel or AUDIO SEL on the remote control repeatedly to select AUTO or HDMI as the input mode.

The following front panel displays are examples where DVD is selected as the input source.

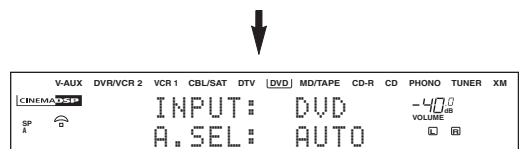

or

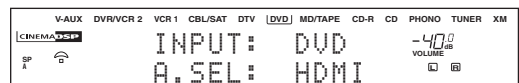

- 3 Start playback on the connected HDMI component.

# TROUBLESHOOTING

Refer to the chart below when this unit does not function properly. If the problem you are experiencing is not listed below or if the instruction below does not help, set this unit to the standby mode, disconnect the power cable, and contact the nearest authorized YAMAHA dealer or service center.

## ■ General

Problem	Cause	Remedy	See page
<b>This unit fails to turn on when MAIN ZONE ON/OFF on the front panel (or POWER on the remote control) is pressed, or enters in the standby mode soon after the power has been turned on.</b>	The power cable is not connected or the plug is not completely inserted.	Connect the power cable firmly.	—
	The impedance setting is incorrect.	Set the impedance to match your speakers.	31
	The protection circuitry has been activated.	Make sure all speaker wire connections on this unit and on all speakers are secure and that the wire for each connection does not touch anything other than its respective connection.	15
	This unit has been exposed to a strong external electric shock (such as lightning and strong static electricity).	Set this unit in the standby mode, disconnect the power cable, plug it back in after 30 seconds and then use it normally.	—
<b>No sound</b>	Incorrect input or output cable connections.	Connect the cables properly. If the problem persists, the cables may be defective.	20–28
	The optimizer microphone is connected.	Disconnect the optimizer microphone.	—
	The input mode is set to HDMI, COAX/OPT or ANALOG.	Set the input mode to AUTO.	44
	No appropriate input source has been selected.	Select an appropriate input source with INPUT, MULTI CH INPUT or the input selector buttons on the remote control.	37
	Speaker connections are not secure.	Secure the connections.	15
	The front speakers to be used have not been selected properly.	Select the front speakers by pressing SPEAKERS A or B on the front panel (or by pressing SPEAKERS A or B on the remote control).	37
	The volume is turned down.	Turn up the volume.	—
	The sound is muted.	Press MUTE or any operation buttons of this unit to cancel a mute and adjust the volume.	39
	The input mode is set to ANALOG while playing a source encoded with a DTS signal.	Set the input mode to AUTO or COAX/OPT.	44
	The signals this unit cannot reproduce (a CD-ROM, for example) are being received from a source component.	Play a source whose signals this unit can reproduce.	—
	The HDMI components connected to this unit do not support the HDCP copy protection standards.	Connect HDMI components that support the HDCP copy protection standards.	—
Support Audio is set to Other and HDMI audio signals are not being played back on this unit.	Set Support Audio to RX-V2600 in HDMI Set.	99	
<b>No picture</b>	Conversion is set to Off.	Set Conversion to On.	88
	Video signals in the progressive format or HDTV video signals are being input.		
	The signals input at the HDMI IN 1 or HDMI IN 2 jack are being output at the HDMI OUT jack.		

Problem	Cause	Remedy	See page
<b>The sound suddenly goes off.</b>	The protection circuitry has been activated because of a short circuit, etc.	Check that the impedance selector setting is correct.	31
		Check the speaker wires are not touching each other and then turn this unit back on.	—
	The sleep timer has turned the unit off.	Turn on the power, and play the source again.	—
	The sound is muted.	Press MUTE to cancel a mute.	39
<b>Only the speaker on one side can be heard.</b>	Incorrect cable connections.	Connect the cables properly. If the problem persists, the cables may be defective.	20
	Incorrect balance settings in the GUI menu.	Adjust the Speaker Level settings.	93
<b>Only the center speaker outputs substantial sound.</b>	When playing a monaural source with a CINEMA DSP program, the source signal is directed to the center channel, and the front and surround speakers output effect sounds.		
<b>No sound from the effect speakers</b>	The sound field programs are turned off.	Press STRAIGHT (EFFECT) to turn them on.	43
	You are using a source or program combination that does not output sound from all channels.	Try another sound field program.	37
<b>No sound from the center speaker</b>	The output level of the center speaker is set to minimum.	Raise the level of the center speaker.	93
	Center is set to None in Speaker Set.	Select the appropriate setting for the center speaker.	90
	One of the HiFi DSP programs (except for 7ch Stereo) has been selected.	Try another sound field program.	37
<b>No sound from the surround speakers</b>	The output level of the surround speakers is set to minimum.	Raise the output level of the surround speakers.	93
	Surround is set to None in Speaker Set.	Select the appropriate setting for the surround left and right speakers.	90
	A monaural or stereo source is being played with STRAIGHT.	Press STRAIGHT (EFFECT) to turn on the sound fields.	—
<b>No sound from the surround back speakers</b>	Presence speakers are selected.	Select Surround Back in PR/SB Priority.	86
	Surround is set to None in Speaker Set.	If the surround left and right speakers are set to None, surround back speakers are automatically set to None. Select the appropriate setting for the surround left and right speakers.	90
	Surround Back is set to None in Speaker Set.	Select Small x1, Small x2, Large x1 or Large x2.	90
<b>No sound from the subwoofer</b>	Bass Out is set to Front when a Dolby Digital or DTS signal is being played.	Select SWFR or Both.	92
	Bass Out is set to SWFR or Front when a 2-channel source is being played.	Select Both.	92
	The source does not contain low bass signals.		

Problem	Cause	Remedy	See page
<b>Dolby Digital or DTS sources cannot be played. (Dolby Digital or DTS indicator in the front panel display does not light up.)</b>	The connected component is not set to output Dolby Digital or DTS digital signals.	Make an appropriate setting following the operations instructions for your component.	—
	The input mode is set to ANALOG.	Set the input mode to AUTO or COAX/OPT.	44
<b>A humming sound can be heard.</b>	Incorrect cable connections.	Firmly connect the audio plugs. If the problem persists, the cables may be defective.	—
	No connection from the turntable to the GND terminal.	Connect the grounding cord of your turntable to the GND terminal of this unit.	27
<b>The volume level is low while playing a record.</b>	The record is being played on a turntable with an MC cartridge.	The turntable should be connected to this unit through an MC-head amplifier.	27
<b>The volume level cannot be increased, or the sound is distorted.</b>	The component connected to the OUT (REC) jacks of this unit is turned off.	Turn on the power to the component.	—
<b>The sound effect cannot be recorded.</b>	It is not possible to record the sound effect with a recording component.		
<b>A source cannot be recorded by a digital recording component connected to this DIGITAL OUTPUT jack.</b>	The source component is not connected to this unit's DIGITAL INPUT jacks.	Connect the source component to the DIGITAL INPUT jacks.	20–27
	Some components cannot record the Dolby Digital or DTS sources.		
<b>A source cannot be recorded by an analog component connected to the AUDIO OUT jacks.</b>	The source component is not connected to the analog AUDIO IN jacks of this unit.	Connect the source component to the analog AUDIO IN jacks.	20–27
<b>The sound field parameters and some other settings on this unit cannot be changed.</b>	Memory Guard is set to On.	Select Off.	98
<b>This unit does not operate properly.</b>	The internal microcomputer has been frozen by an external electric shock (such as lightning or excessive static electricity) or by a power supply with low voltage.	Disconnect the AC power cable from the outlet and then plug it in again after about 30 seconds.	—
<b>CHECK SP WIRES appears in the front panel display.</b>	Speaker cables are short circuited.	Make sure all speaker cables are connected correctly.	15
<b>There is noise interference from digital or radio-frequency equipment, or this unit.</b>	This unit is too close to the digital or radio-frequency equipment.	Move this unit further away from such equipment.	—
<b>The picture is disturbed.</b>	The video source uses scrambled or encoded signals to prevent dubbing.		
<b>This unit suddenly enters the standby mode.</b>	The internal temperature becomes too high and the overheat protection circuitry has been activated.	Wait for about 1 hour until this unit cools down and then turn it back on.	—

## ■ Tuner

Problem		Cause	Remedy	See page
FM	FM stereo reception is noisy.	The characteristics of FM stereo broadcasts may cause this problem when the transmitter is too far away or the antenna input is poor.	Check the antenna connections. Try using a high-quality directional FM antenna.	29
			Use the manual tuning method.	48
	There is distortion, and clear reception cannot be obtained even with a good FM antenna.	There is multipath interference.	Adjust the antenna position to eliminate multipath interference.	—
	The desired station cannot be tuned in with the automatic tuning method.	The signal is too weak.	Use a high-quality directional FM antenna.	29
			Use the manual tuning method.	48
Previously preset stations can no longer be tuned in.	This unit has been disconnected for a long period.	Preset the stations again.	48	
AM	The desired station cannot be tuned in with the automatic tuning method.	The signal is weak or the antenna connections are loose.	Tighten the AM loop antenna connections and orient it for the best reception.	—
			Use the manual tuning method.	48
	There are continuous crackling and hissing noises.	Noises result from lightning, fluorescent lamps, motors, thermostats and other electrical equipment.	Use an outdoor antenna and a ground wire. This will help somewhat, but it is difficult to eliminate all noise.	—
	There are buzzing and whining noises.	A TV set is being used nearby.	Move this unit away from the TV.	—

## ■ XM Satellite Radio

If an operation takes longer than usual or an error occurs, one of the following messages may appear in the front panel display. In this case, read the cause and follow the corresponding remedies.

Status message	Cause	Remedy	See page
<b>CHECK ANTENNA</b>	The XM Connect-and-Play digital antenna accessory is not connected, or does not work properly.	Check the XM Connect-and-Play digital antenna accessory connections.	53
<b>UPDATING</b>	The XM user encryption code is being updated.	Wait until the encryption code is updated.	—
<b>NO SIGNAL</b>	The signal is too weak.	Check the XM Connect-and-Play digital antenna accessory connections and orient it for the best reception.	53
<b>LOADING</b>	It takes longer than four seconds for audio or text data to be decoded.	Wait until the decoding process has finished.	—
<b>OFF AIR</b>	The XM Satellite Radio channel you selected is not currently broadcasting any signal.	Check the channel number again or select another XM Satellite Radio channel.	57
<XM> ---	The channel Station ID (SID) is no longer available.		
--- / ---	No artist name/feature or song/program title is available.		
<CAT> ---	No channels are available for the selected category.	Select another channel category by pressing CATEGORY (or A-E/CAT. <1/> on the remote control) repeatedly.	57



## ■ Remote control

Problem	Cause	Remedy	See page
<b>The remote control does not work or function properly.</b>	Wrong distance or angle.	The remote control will function within a maximum range of 6 m (20 ft) and no more than 30 degrees off-axis from the front panel.	5
	Direct sunlight or lighting (from an inverter type of fluorescent lamp, etc.) is striking the remote control sensor of this unit.	Reposition this unit.	—
	The batteries are weak.	Replace all batteries.	4
	AMP/SOURCE/TV is set incorrectly.	Set AMP/SOURCE/TV correctly. When operating this unit, set it to the AMP position. When operating the component selected by the input selector button, set it to the SOURCE position. When operating the TV set in the DTV or PHONO area, set it to the TV position.	—
	The remote control code was not correctly set.	Set the remote control code correctly using "LIST OF REMOTE CONTROL CODES" at the end of this manual.	105
		Try setting another code of the same manufacturer using "LIST OF REMOTE CONTROL CODES" at the end of this manual.	105
	The library code of the remote control and the remote control ID of this unit do not match.	Match the remote control ID of this unit with the corresponding remote control library code.	102, 105
	Even if the remote control code is correctly set, there are some models that do not respond to the remote control.	Program the necessary functions independently into the programmable buttons using the Learn feature.	107
The batteries do not last long and get quickly exhausted.	Using alkaline batteries is strongly recommended.	—	
<b>The remote control does not learn new functions.</b>	The batteries of this remote control and/or the other remote control are too weak.	Replace the batteries.	4
	The distance between the two remote controls is too much or too little.	Place the remote controls at the proper distance.	107
	The signal coding or modulation of the other remote control is not compatible with this remote control.	Learning is not possible.	—
	Memory capacity is full.	Delete other unnecessary functions to make room for the new functions.	112

## ■ AUTO SETUP

### Before AUTO SETUP

Error message	Cause	Remedy	See page
<b>Connect MIC!</b>	Optimizer microphone is not connected.	Connect the supplied optimizer microphone to the OPTIMIZER MIC jack on the front panel.	32
<b>Unplug Phones!</b>	Headphones are connected.	Unplug the headphones.	—
<b>No Setup Menu!</b>	No setup menu items have been selected.	Select at least one setup menu item.	—
<b>Memory Guard!</b>	This setting is protected.	Remove the protection setting for AUTO SETUP.	98

### During AUTO SETUP

Error message	Cause	Remedy	See page
<b>E01:No Front SP</b>	Front L/R channel signal(s) is (are) not detected.	Select the front speakers by pressing SPEAKER A or B on the front panel (or by setting AMP/SOURCE/TV to AMP and then pressing SPEAKER A or B on the remote control).	—
		Check the front L/R speaker connections.	15
<b>E02:No Surr. SP</b>	A surround channel signal is not detected.	Check the surround speaker connections.	15
<b>E03:No PRNS SP</b>	A presence channel signal is not detected.	Check the presence speaker connections.	15
<b>E04:SBR→SBL</b>	Only right surround back channel signal is detected.	Connect the surround back speaker to the LEFT SURROUND BACK SPEAKERS terminal if you only have one surround back speaker.	15
<b>E05:Noisy</b>	Background noise is too loud.	Try running AUTO SETUP in a quiet environment.	—
		Turn off noisy electric equipment like air conditioners or move them away from the optimizer microphone.	—
<b>E06:Check Surr.</b>	Surround back speaker(s) is (are) connected, though surround L/R speakers are not.	Connect surround speakers when you use (a) surround back speaker(s).	15
<b>E07:No MIC</b>	The optimizer microphone was unplugged during the AUTO SETUP procedure.	Connect the supplied optimizer microphone to OPTIMIZER MIC jack on the front panel.	32
<b>E08:No Signal</b>	The optimizer microphone does not detect test tones.	Check the microphone setting.	32
		Check the speaker connections and placement.	15
<b>E09:User Cancel</b>	The AUTO SETUP procedure was cancelled due to user activity.	Run AUTO SETUP again.	32
<b>E10:Internal Err</b>	An internal error occurred.	Run AUTO SETUP again.	32

## After AUTO SETUP

Warning message	Cause	Remedy	See page
<b>W1:Out of Phase</b>	Speaker polarity is not correct. This message may appear depending on the speakers even when the speakers are connected correctly.	Check the speaker connections for proper polarity (+ or -).	15
<b>W2:Over24m/80ft</b>	The distance between the speaker and the listening position is over 24 m (80 ft).	Bring the speaker closer to the listening position.	—
<b>W3:Level Error</b>	The difference of volume level among speakers is excessive. (No level correction is made.)	Readjust the speaker installation so that all speakers are set in locations with similar conditions.	—
		Check the speaker connections.	15
		Use speakers of similar quality.	—
		Adjust the output volume of the subwoofer.	33
<b>W4:SP Mismatch</b>	The Wiring results are incompatible with the current user settings.	The current user settings will take priority.	—

**Notes**

- If the ERROR or WARNING screens appears, check the cause of the problem and then perform the AUTO SETUP procedure again.
- If warning W-1 or W-4 appears, corrections are made, but they may not be optimal.
- If warning W-2 or W-3 appears, no corrections are made.
- If error E-10 occurs repeatedly, please contact a qualified YAMAHA service center.

■ **HDMI**

Error message	Cause	Remedy	See page
<b>Device Over</b>	More than 5 HDMI components including this unit are connected.	Reduce the number of the connected HDMI components.	—
<b>HDCP Error</b>	HDCP testing failed.	Check that the connected HDMI components support the HDCP copy protection standards.	—

## *Audio information*

### ■ **ASA (Advanced Speaker Array)**

ASA is a proprietary THX technology which processes the sound fed to 2 side and 2 back surround speakers to provide the optimal surround sound experience. When you set up your home theater system using all eight speaker outputs (Left, Center, Right, Surround Right, Surround Back Right, Surround Back Left, Surround Left and Subwoofer) placing the two Surround Back speakers close together facing the front of the room will provide the largest sweet spot. If for practical reasons you have to place the Surround Back speakers apart, you will need to go THX Audio Set-up screen and choose the setting that most closely corresponds to the speaker spacing, which will re-optimized the surround sound-field. ASA is used in three new modes: THX Select2 Cinema, THX Music Mode and THX Games Mode.

### ■ **Dolby Digital**

Dolby Digital is a digital surround sound system that gives you completely independent multi-channel audio. It provides 5 full-range audio channels; 3 front channels (left, center, and right), and 2 surround stereo channels. An additional channel especially for bass effects, called LFE (low frequency effect) is also provided giving the system a total of 5.1-channels (LFE is counted as a 0.1 channel). By using 2-channel stereo for the surround speakers, more accurate moving sound effects and surround sound environment are possible than with Dolby Surround. The wide dynamic range (maximum to minimum volume) reproduced by the 5 full-range channels and the precise sound orientation generated using digital sound processing provide listeners with a previously unheard of excitement and realism.

### ■ **Dolby Digital EX**

Dolby Digital EX creates 6 full-bandwidth output channels from 5.1-channel sources. This is done by using a matrix decoder that derives 3 surround channels from the 2 in the original recording. For best results, Dolby Digital EX should be used with movie sound tracks recorded with Dolby Digital Surround EX. With this additional channel, you can experience more dynamic and realistic moving sound especially with scenes that have flyover and fly-around effects.

### ■ **Dolby Pro Logic IIx**

Dolby Pro Logic IIx is a new technology enabling 6.1 or 7.1 multi-channel playback from 2-channel or multi-channel sources. There is a Music mode for music, a Movie mode for movies and a Game mode for games.

### ■ **Dolby Surround**

Dolby Surround uses a 4 channel analog recording system to reproduce realistic and dynamic sound effects: 2 front left and right channels (stereo), a center channel for dialog (monaural), and a surround channel for special sound effects (monaural). The surround channel reproduces sound within a narrow frequency range.

Dolby Surround is widely used with nearly all video tapes and laser discs, and in many TV and cable broadcasts as well. The Dolby Pro Logic decoder built into this unit employs a digital signal processing system that automatically stabilizes the volume on each channel to enhance moving sound effects and directionality.

### ■ **DTS 96/24**

DTS 96/24 offers an unprecedented level of audio quality for multi-channel sound on DVD-Video, and is fully backward-compatible with all DTS decoders. 96 refers to a 96 kHz sampling rate (compared to the typical 48 kHz sampling rate). 24 refers to 24-bit word length. DTS 96/24 offers sound quality transparent to the original 96/24 master, and 96/24 5.1-channel sound with full-quality full-motion video for music programs and motion picture soundtracks on DVD-video.

### ■ **DTS (Digital Theater Systems) Digital Surround**

DTS digital surround was developed to replace the analog soundtracks of movies with a 6-channel digital sound track, and is now rapidly gaining popularity in movie theaters around the world. Digital Theater Systems Inc. has developed a home theater system so that you can enjoy the depth of sound and natural spatial representation of DTS digital surround in your home. This system produces practically distortion-free 6-channel sound (technically, left, right and center channels, 2 surround channels, plus an LFE 0.1 channel as a subwoofer, for a total of 5.1-channels). This unit incorporates a DTS-ES decoder that enables 6.1-channel reproduction by adding a surround back channel to the existing 5.1-channel format.

### ■ **ITU-R**

ITU-R is the radio communication sector of the ITU (International Telecommunication Union). ITU-R recommends a standard speaker placement which is used in many critical listening rooms, such as mastering studios.

### ■ LFE 0.1 channel

This channel is for the reproduction of low bass signals. The frequency range for this channel is 20 Hz to 120 Hz. This channel is counted as 0.1 because it only enforces a low frequency range compared to the full-range reproduced by the other 5/6 channels in Dolby Digital or DTS 5.1/6.1-channel systems.

### ■ Neo:6

Neo:6 decodes conventional 2-channel sources for 6 channel playback by. It enables playback with the full-range channels with higher separation comparable to digital discrete signal playback. Two modes are available; Music mode for playing music sources and Cinema mode for movies.

### ■ PCM (Linear PCM)

Linear PCM is a signal format under which an analog audio signal is digitized, recorded and transmitted without using any compression. This is used as a method of recording CDs and DVD audio. The PCM system uses a technique for sampling the size of the analog signal per very small unit of time. Standing for pulse code modulation, the analog signal is encoded as pulses and then modulated for recording.

### ■ Sampling frequency and number of quantized bits

When digitizing an analog audio signal, the number of times the signal is sampled per second is called the sampling frequency, while the degree of fineness when converting the sound level into a numeric value is called the number of quantized bits.

The range of rates that can be played back is determined based on the sampling rate, while the dynamic range representing the sound level difference is determined by the number of quantized bits. In principle, the higher the sampling frequency, the wider the range of frequencies that can be played back, and the higher the number of quantized bits, the more finely the sound level can be reproduced.

### ■ THX Cinema processing

THX is an exclusive set of standards and technologies established by the world-renowned film production company, Lucasfilm Ltd. THX grew from George Lucas' personal desire to make your experience of the film soundtrack, in both movie theaters and in your home theater, as faithful as possible to what the director intended.

Movie soundtracks are mixed in special movie theaters called dubbing stages and are designed to be played back in movie theaters with similar equipment and conditions. This same soundtrack is then transferred directly onto Laserdisc, VHS tape, DVD, etc., and is not changed for playback in a small home theater environment.

THX engineers developed patented technologies to accurately translate the sound from the movie theater environment into the home, correcting the tonal and spatial errors that occur. On this product, when the THX indicator is on, THX features are automatically added in Cinema modes (e.g. THX Cinema, THX Surround EX).

### Adaptive decorrelation

In a movie theater, a large number of surround speakers help create an enveloping surround sound experience, but in a home theater there are usually only two speakers. This can make the surround speakers sound like headphones that lack spaciousness and envelopment. The surround sounds will also collapse into the closest speaker as you move away from the middle seating position. Adaptive decorrelation slightly changes one surround channel's time and phase relationship with respect to the other surround channel. This expands the listening position and creates – with only two speakers – the same spacious surround experience as in a movie theater.

### Re-equalization

The tonal balance of a film soundtrack will be excessively bright and harsh when played back over audio equipment in the home because film soundtracks were designed to be played back in large movie theaters using very different professional equipment. Re-equalization restores the correct tonal balance for watching a movie soundtrack in a small home environment.

### Timbre matching

The human ear changes our perception of sound depending on the direction from which it is coming. In a movie theater, there is an array of surround speakers so that the surround information is all around you. In a home theater, you use only two speakers located to the side of your head. The timbre matching feature filters the information going to the surround speakers so that they more closely match the tonal characteristics of the sound coming from the front speakers. This ensures seamless panning between the front and surround speakers.

### ■ THX Games Mode

For the replay of stereo and multi-channel game audio the THX Games Mode should be selected. In this mode THX ASA processing is applied to the surround channels of all 5.1 and 2.0 encoded game sources such as analog, PCM, DTS and Dolby Digital. This accurately places all game audio surround information, providing a full 360 degree playback environment. THX Games Mode is unique as it gives you a smooth transition of audio in all points of the surround field.

### ■ THX Music Mode

For the replay of multi-channel music the THX Music Mode should be selected. In this mode THX ASA processing is applied to the surround channels of all 5.1 encoded music sources such as DTS, Dolby Digital and DVD-Audio to provide a wide stable rear soundstage.

### ■ THX Select2

Before any home theater component can be THX Select2 certified, it must incorporate all the features described in THX Cinema processing and also pass a rigorous series of quality and performance tests. Only then can a product feature the THX Select2 logo, which is your guarantee that the Home Theater products you purchase will give you superb performance for many years to come. THX Select2 requirements cover every aspect of the product including power amplifier and pre-amplifier performance and operation, and hundreds of other parameters in both the digital and analog domain.

### ■ THX Select2 Cinema mode

THX Select2 Cinema mode plays 5.1 movies using all 8 speakers giving you the best possible movie watching experience. In this mode ASA processing blends the side surround speakers and back surround speakers providing the optimal mix of ambient and directional surround sounds.

DTS-ES (Matrix and 6.1 Discrete) and Dolby Digital Surround EX encoded soundtracks will be automatically detected in THX Select2 Cinema mode if the appropriate flag has been encoded.

Some Dolby Digital Surround EX soundtracks are missing the digital flag that allows automatic switching. If you know that the movie that you are watching is encoded in Surround EX, you can manually select the THX Surround EX playback mode; otherwise, THX Select2 Cinema mode will apply ASA processing to provide optimum replay.

### ■ THX Surround EX

THX Surround EX-Dolby Digital Surround EX is a joint development of Dolby Laboratories and the THX Ltd. In a movie theater, film soundtracks that have been encoded with Dolby Digital Surround EX technology are able to reproduce an extra channel which has been added during the mixing of the program. This channel, called Surround Back, places sounds behind the listener in addition to the currently available front left, front center, front right, surround right, surround left and subwoofer channels. This additional channel provides the opportunity for more detailed imaging behind the listener and brings more depth, spacious ambience and sound localization than ever before.

Movies that were created using the Dolby Digital Surround EX technology, when released into the home consumer market may exhibit wording to that effect on the packaging. A list of movies created using this technology can be found on the Dolby web site at [www.dolby.com](http://www.dolby.com). A list of available DVD software titles encoded with this technology can be found at [www.thx.com](http://www.thx.com).

Only receiver and controller products bearing the THX Surround EX logo, when in the THX Surround EX mode, faithfully reproduce this new technology in the home.

This product may also engage the THX Surround EX mode during the playback of 5.1 channel material that is not Dolby Digital Surround EX encoded. In such cases the information delivered to the Surround Back channel will be program dependent and may or may not be pleasing depending on the particular soundtrack and the tastes of the individual listener.

## Video information

### ■ Component video signal

With the component video signal system, the video signal is separated into the Y signal for the luminance and the P<sub>B</sub> and P<sub>R</sub> signals for the chrominance. Color can be reproduced more faithfully with this system because each of these signals is independent. A monitor with component input jacks is required in order to use the component signal for output.

### ■ Composite video signal

With the composite video signal system, the video signal is composed of three basic elements of a video picture; color, luminance and synchronization data. A composite video jack on a video component transmits these three elements combined.

### ■ S-video signal

With the S-video signal system, the video signal normally transmitted using a pin cable is separated and transmitted as the Y signal for the luminance and the C signal for the chrominance through the S-video cable. Using the S VIDEO jack eliminates video signal transmission loss and allows recording and playback of even more beautiful images.

## Sound field program information

### ■ CINEMA DSP

Since the Dolby Surround and DTS systems were originally designed for use in movie theaters, their effect is best felt in a theater having many speakers and designed for acoustic effects. Since home conditions, such as room size, wall material, number of speakers, and so on, can differ so widely, it's inevitable that there are differences in the sound heard. Based on a wealth of actually measured data, YAMAHA CINEMA DSP uses YAMAHA original sound field technology to combine Dolby Pro Logic, Dolby Digital and DTS systems to provide the visual and audio experience of a movie theater in the listening room of your own home.

### ■ SILENT CINEMA

YAMAHA has developed a natural, realistic sound effect DSP algorithm for headphones. Parameters for headphones have been set for each sound field so that accurate representations of all the sound field programs can be enjoyed on headphones.

### ■ Virtual CINEMA DSP

YAMAHA has developed a Virtual CINEMA DSP algorithm that allows you to enjoy DSP sound field surround effects without any surround speakers by using virtual surround speakers. It is even possible to enjoy Virtual CINEMA DSP using a minimal two-speaker system that does not include a center speaker.

## Parametric equalizer information

This unit employs YAMAHA Parametric Room Acoustic Optimizer (YPAO) technology, together with the Parametric EQ settings (see page 84), to optimize the frequency characteristics of its parametric equalizer to match your listening environment. YPAO uses a combination of the following three parameters (Frequency, Gain and Q factor) to provide highly precise adjustment of the frequency characteristics.

### ■ Frequency

This parameter is adjustable in one-third octave increments between 63 Hz and 16 kHz.

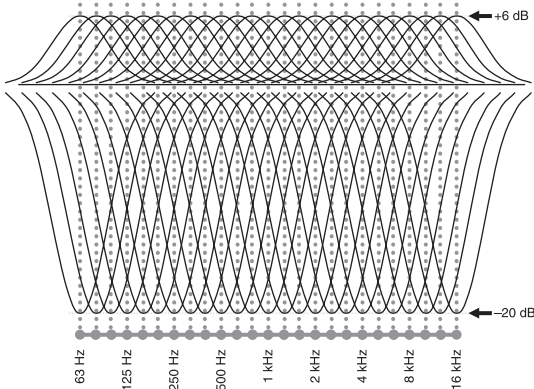

### ■ Gain

This parameter is adjustable in increments of 0.5 dB between -20 and +6 dB.

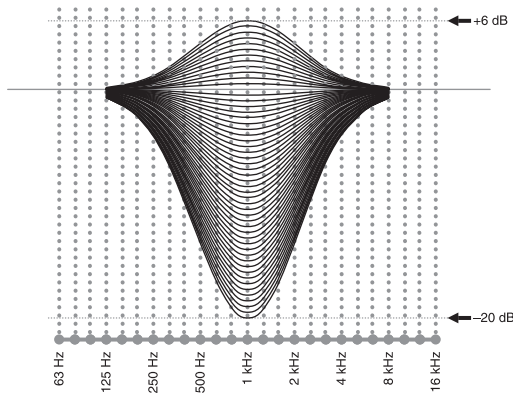

### ■ Q factor

The width of the specified frequency band is referred to as the Q factor. This parameter is adjustable between the values 0.5 and 10.

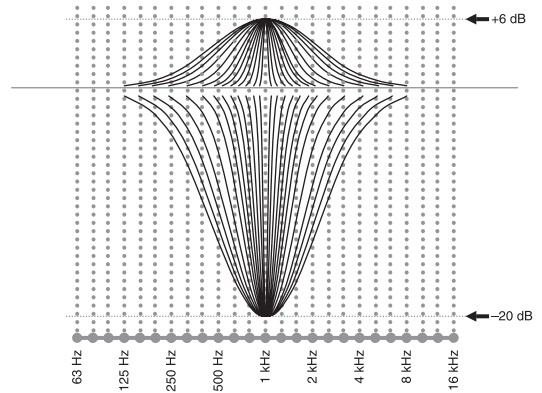

YPAO adjusts frequency characteristics to suit your listening requirements using a combination of the above three parameters (Frequency, Gain and Q factor) for each equalizer band in this unit's parametric equalizer. This unit has 7 equalizer bands for each channel.

The use of multiple equalizer bands enables more precise adjustments of frequency characteristics (as in Figure 2). This is not possible using only a single equalizer band (as in Figure 1).

Figure 1

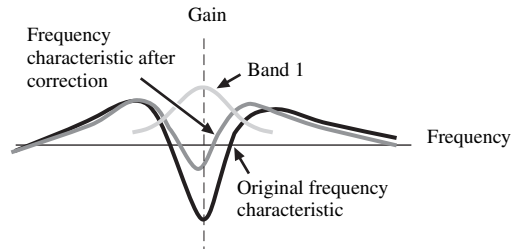
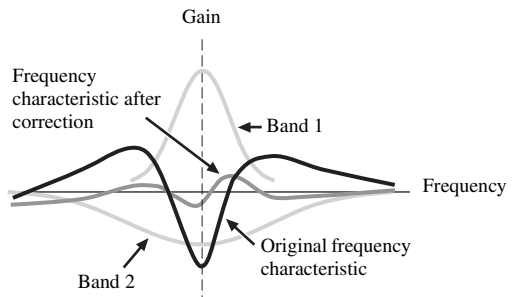

Figure 2





# SPECIFICATIONS

## AUDIO SECTION

- Minimum RMS Output Power for Front, Center, Surround, Surround back  
20 Hz to 20 kHz, 0.04% THD, 8  $\Omega$  ..... 130 W
- Dynamic Power (IHF)  
8/6/4/2  $\Omega$  ..... 165/205/260/340 W
- Maximum Power (EIAJ)  
[Asia, General, China and Korea models]  
1 kHz, 10% THD, 6  $\Omega$  ..... 180 W
- Maximum Output Power [U.K. and Europe models]  
1 kHz, 0.7% THD, 4  $\Omega$  ..... 190 W
- Dynamic Headroom  
8  $\Omega$  ..... 1.11 dB
- IEC Output Power [U.K. and Europe models]  
1 kHz, 0.04% THD, 8  $\Omega$  ..... 140 W
- Damping Factor (IHF)  
20 Hz to 20 kHz, 8  $\Omega$  ..... 140 or more
- Input Sensitivity/Input Impedance  
PHONO ..... 3.5 mV/47 k $\Omega$   
CD, etc. .... 200 mV/47 k $\Omega$   
MULTI CH INPUT ..... 200 mV/47 k $\Omega$
- Maximum Input Signal  
PHONO (1 kHz, 0.1% THD) ..... 60 mV or more  
CD, etc. (1 kHz, 0.5% THD) ..... 2.4 V or more
- Output Level/Output Impedance  
OUT (REC) ..... 200 mV/1.2 k $\Omega$   
PRE OUT ..... 1.0 V/500  $\Omega$   
SUBWOOFER ..... 2.0 V/500  $\Omega$   
ZONE 2/ZONE 3 OUT  
[U.S.A., Canada, Australia, U.K. and Europe models]  
..... 1.0 V/1.2 k $\Omega$
- Headphone Jack Rated Output/Impedance  
CD, etc. (1 kHz, 40 mV, 8  $\Omega$ ) ..... 150 mV/100  $\Omega$
- Frequency Response  
CD to Front L/R ..... 10 Hz to 100 kHz, +0/-3 dB
- RIAA Equalization Deviation  
PHONO (20 Hz to 20 kHz) ..... 0  $\pm$  0.5 dB
- Total Harmonic Distortion  
PHONO to OUT (REC)  
(20 Hz to 20 kHz, 1 V) ..... 0.02% or less  
CD, etc. to Front L/R  
(20 Hz to 20 kHz, 65 W, 8  $\Omega$ ) ..... 0.04% or less
- Signal to Noise Ratio (IHF-A Network)  
PHONO (5 mV) to Front L/R  
[Australia, U.K. and Europe models] ..... 81 dB or more  
[Other models] ..... 86 dB or more  
CD, etc. (250 mV) to Front L/R ..... 100 dB or more
- Residual Noise (IHF-A Network)  
Front L/R ..... 150  $\mu$ V or less
- Channel Separation (1 kHz/10 kHz)  
PHONO (shortened) to Front L/R ..... 60 dB/55 dB or more  
CD, etc.  
(5.1 k $\Omega$  shortened) to Front L/R ..... 60 dB/45 dB or more

- Tone Control Characteristics (Front L/R)  
BASS Boost/Cut .....  $\pm$ 6 dB/50 Hz  
BASS Turnover Frequency ..... 350 Hz  
TREBLE Boost/Cut .....  $\pm$ 6 dB/20 kHz  
TREBLE Turnover Frequency ..... 3.5 kHz
- Zone 2/Zone 3 Tone Control Characteristics (Front L/R)  
BASS Boost/Cut .....  $\pm$ 10 dB/100 Hz  
BASS Turnover Frequency ..... 450 Hz  
TREBLE Boost/Cut .....  $\pm$ 10 dB/20 kHz  
TREBLE Turnover Frequency ..... 1.5 kHz
- Filter Characteristics (fc=40/60/80/90/100/110/120/160/200 Hz)  
H.P.F. (Front, Center, Surround, Surround back) ..... 12 dB/oct.  
L.P.F. (Subwoofer) ..... 24 dB/oct.

## VIDEO SECTION

- Video Signal Type (Gray Back)  
[U.S.A., Canada, General and Korea models] ..... NTSC  
[U.K., Europe, Australia, Asia and China models] ..... PAL
- Video Signal Type (Video Conversion) ..... NTSC/PAL
- Signal Level  
Composite ..... 1 V<sub>p-p</sub>/75  $\Omega$   
S-video ..... 1 V<sub>p-p</sub>/75  $\Omega$  (Y), 0.286 V<sub>p-p</sub>/75  $\Omega$  (C)  
Component ..... 1 V<sub>p-p</sub>/75  $\Omega$  (Y), 0.7 V<sub>p-p</sub>/75  $\Omega$  (P<sub>B</sub>/P<sub>R</sub>)
- Maximum Input Level (V CONV. off) ..... 1.5 V<sub>p-p</sub> or more
- Signal to Noise Ratio (V CONV. off) ..... 60 dB or more
- Frequency Response (MONITOR OUT)  
Component (V CONV. off) ..... 5 Hz to 100 MHz,  $\pm$ 3 dB

## FM SECTION

- Tuning Range  
[U.S.A. and Canada models] ..... 87.5 to 107.9 MHz  
[Asia and General models] ..... 87.5/87.50 to 108.0/108.00 MHz  
[Other models] ..... 87.50 to 108.00 MHz
- 50 dB Quieting Sensitivity (IHF)  
Mono/Stereo ..... 2.0/25  $\mu$ V (17.3/39.2 dBf)
- Usable Sensitivity (IHF) ..... 1.0  $\mu$ V (11.2 dBf)
- Selectivity (400 kHz) ..... 70 dB
- Signal to Noise Ratio (IHF)  
Mono/Stereo ..... 76 dB/70 dB
- Harmonic Distortion (1 kHz)  
Mono/Stereo ..... 0.2/0.3%
- Stereo Separation (1 kHz)  
Stereo ..... 42 dB
- Frequency Response  
Stereo ..... 20 Hz to 15 kHz, +0.5, -2 dB
- Antenna Input (unbalanced) ..... 75  $\Omega$

## AM SECTION

- Tuning Range  
[U.S.A. and Canada models] ..... 530 to 1710 kHz  
[Asia and General models] ..... 530/531 to 1710/1611 kHz  
[Other models] ..... 531 to 1611 kHz
- Usable Sensitivity ..... 300  $\mu$ V/m

**GENERAL**

- Power Supply
  - [U.S.A. and Canada models] ..... AC 120 V, 60 Hz
  - [General and Asia model]
    - ..... AC 110/120/220/230–240 V, 50/60 Hz
  - [China model] ..... AC 220 V, 50 Hz
  - [Korea model] ..... AC 220 V, 60 Hz
  - [Australia model] ..... AC 240 V, 50 Hz
  - [U.K. and Europe models] ..... AC 230 V, 50 Hz
- Power Consumption
  - [U.S.A. and Canada models] ..... 500 W/630 VA
  - [Other models] ..... 500 W
- Standby Power Consumption
  - [U.S.A. and Canada models] ..... 0.1 W or less
  - [General model] (AC 240 V, 50 Hz) ..... 0.33 W or less
  - [Other models] ..... 0.1 W or less
- Maximum Power Consumption [General model only]
  - 6ch, 10% THD ..... 1100 W
- AC Outlets
  - [U.S.A. and Canada models] .... 2 (Total 100 W/0.8 A maximum)
  - [Asia, General and China models] ..... 2 (Total 50 W maximum)
  - [Australia and U.K. models] .... 1 (Total 100 W/0.4 A maximum)
  - [Europe model] ..... 2 (Total 100 W/0.4 A maximum)
- Dimensions (W x H x D) ..... 435 x 171 x 438 mm  
 (17.1 x 6.7 x 17.2 in)
- Weight ..... 17.4 kg (38.4 lbs)

\* Specifications are subject to change without notice.

# LIST OF REMOTE CONTROL CODES

## CABLE

ABC 0030, 0035  
 AMERICAST 0926  
 BELL SOUTH 0926  
 BIRMINGHAM CABLE COMMUNICATIONS 0303  
 BRITISH TELECOM 0030  
 CABLE & WIRELESS 1095  
 DAERYUNG 0035, 0504, 0904, 1904  
 DIRECTOR 0503  
 FILMNET 0470  
 GENERAL INSTRUMENT 0030, 0303, 0503, 0837,  
 GOLDSTAR 0171  
 HAMLIN 0036, 0300  
 JERROLD 0030, 0303, 0503, 0837  
 LG 0171  
 MNET 0470  
 MEMOREX 0027  
 MOTOROLA 0303, 0503, 0837, 1133  
 NTL 1095  
 NOOS 0844  
 ONO 1095  
 PVP STEREO VISUAL MATRIX 0030  
 PACE 0264, 1087, 1095  
 PANASONIC 0027, 0035, 0134  
 PARAGON 0027  
 PHILIPS 0332, 0344  
 PIONEER 0171, 0560, 0904, 1904  
 PULSAR 0027  
 QUASAR 0027  
 REGAL 0300, 0306  
 RUNCO 0027  
 SAGEM 0844  
 SAMSUNG 0027, 0171  
 SCIENTIFIC ATLANTA 0035, 0504, 0904, 1904  
 SONY 1033  
 STARCOM 0030  
 SUPERCABLE 0303  
 TS 0030  
 TELE+1 0470  
 TELEWEST 1095  
 TORX 0030  
 TOSHIBA 0027  
 TRANS PX 0303  
 UNITED CABLE 0030  
 ZENITH 0027, 0552, 0926

## CD PLAYER

AIWA 0184  
 ARCAM 0184  
 AUDIO RESEARCH 0184  
 AUDIO TON 0184  
 AUDIOLAB 0184  
 AUDIOMECA 0184  
 CAIRN 0184

## CALIFORNIA AUDIO LABS

0056  
 CARVER 0184, 0206  
 CYRUS 0184  
 DKK 0027  
 DMX ELECTRONICS 0184  
 DENON 0900  
 DYNAMIC BASS 0206  
 EMERSON 0332  
 FISHER 0206  
 GENEXXA 0059, 0332  
 GOODMANS 0332  
 GRUNDIG 0184  
 HARMAN/KARDON 0184, 0200  
 HITACHI 0059  
 JVC 0099  
 KENWOOD 0055, 0064  
 KRELL 0184  
 LXI 0332  
 LINN 0184  
 MCS 0056  
 MAGNAVOX 0184, 0332  
 MARANTZ 0056, 0184  
 MATSUI 0184  
 MEMOREX 0332  
 MERIDIAN 0184  
 MICROMEGA 0184  
 MIRO 0027  
 MISSION 0184  
 MYRYAD 0184  
 NAD 0027  
 NSM 0184  
 NAIM 0184  
 OPTIMUS 0027, 0059, 0064, 0206, 0332  
 PANASONIC 0056  
 PHILIPS 0184  
 PIONEER 0059, 0332  
 POLK AUDIO 0184  
 PROTON 0184  
 QED 0184  
 QUAD 0184  
 QUASAR 0056  
 RCA 0059, 0206, 0332  
 REALISTIC 0206  
 REVOX 0184  
 ROTEL 0184  
 SAE 0184  
 SANSUI 0184, 0332  
 SANYO 0206  
 SCOTT 0332  
 SEARS 0332  
 SHARP 0064  
 SIMAUDIO 0184  
 SONIC FRONTIERS 0184  
 SONY 0027  
 SYMPHONIC 0332  
 TAG MCLAREN 0184  
 TANDY 0059  
 TECHNICS 0056  
 THORENS 0184  
 THULE 0184  
 UNIVERSUM 0184  
 VICTOR 0099  
 WARDS 0184  
 YAMAHA 2300, 2301

## CD RECORDER

KENWOOD 0653  
 MARANTZ 0653  
 PHILIPS 0653  
 YAMAHA 2400

## DVD PLAYER

ACOUSTIC SOLUTIONS 0757  
 ALBA 0744  
 AMSTRAD 0740  
 APEX DIGITAL 0699, 0744, 0782, 0821, 0823, 0857, 1127  
 BLAUPINKT 0744  
 BLUE PARADE 0598  
 BUSH 0740  
 CENTREX 0699  
 CLATRONIC 0815  
 CYBERHOME 0741  
 DVD2000 0548  
 DAEWOO 0811, 0797  
 DANSAI 0797  
 DECCA 0797  
 DENON 0517  
 DIAMOND 0795  
 DIGITREX 0699  
 EMERSON 0618  
 ENTERPRISE 0618  
 FISHER 0697  
 GE 0549, 0744  
 GO VIDEO 0742  
 GOLDSTAR 0768  
 GRADIENTE 0678  
 GREENHILL 0744  
 GRUNDIG 0566  
 HITACHI 0600, 0691  
 HITEKER 0699  
 JVC 0585, 0650  
 KLH 0744  
 KENWOOD 0517, 0561  
 KOSS 0678  
 LG 0768  
 LIMIT 0795  
 MAGNAVOX 0530, 0702  
 MARANTZ 0566  
 MEMOREX 0858  
 MICO 0750  
 MICROSOFT 0549  
 MINTEK 0744  
 MITSUBISHI 0548  
 MUSTEK 0757  
 NESA 0744  
 ONKYO 0530  
 ORITRON 0678  
 PALSONIC 0699  
 PANASONIC 0517, 0659, 1389  
 PHILIPS 0530, 0566, 0673, 0881  
 PIONEER 0552, 0598, 0658, 0659  
 POLK AUDIO 0566  
 PROSCAN 0549  
 QWESTAR 0678  
 RCA 0549, 0598, 0744  
 ROTEL 0650

SM ELECTRONIC 0757  
 SAMSUNG 0600  
 SANYO 0697  
 SHARP 0657  
 SHERWOOD 0797  
 SHINSONIC 0560  
 SLIM ART 0811  
 SONY 0560, 0891  
 SYLVANIA 0702  
 TATUNG 0797  
 TEAC 0598, 0744  
 TECHNICS 0517  
 THETA DIGITAL 0598  
 THOMSON 0549  
 TOSHIBA 0530  
 URBAN CONCEPTS 0530  
 XBOX 0549  
 YAMAHA 0517, 0566, 0572, 2100, 2101, 2102  
 ZENITH 0530, 0618, 0768  
 ZEUS 0811

## DVD RECORDER

PANASONIC 2800, 2801, 2802  
 PHILIPS 2808  
 PIONEER 2804, 2805, 2806  
 SHARP 2812, 2813  
 SONY 2809, 2810, 2811  
 TOSHIBA 2803  
 VICTOR 2814  
 YAMAHA 2807

## LD PLAYER

CARVER 0091  
 DENON 0086  
 MARANTZ 0091  
 MITSUBISHI 0086  
 NAD 0086  
 NAGSMI 0086  
 OPTIMUS 0086  
 PHILIPS 0091  
 PIONEER 0086  
 SALORA 0091  
 SONY 0228  
 TELEFUNKEN 0086  
 YAMAHA 2200

## MD RECORDER

KENWOOD 0708  
 ONKYO 0895  
 SHARP 0888  
 SONY 0517  
 YAMAHA 2500, 2501, 2502

## RECEIVER (TUNER)

ADC 0558  
 AIWA 0185, 1116, 1415, 1432, 1668  
 ALCO 1417  
 ANAM 1636  
 APEX DIGITAL 1284  
 AUDIOLAB 1216  
 AUDIOTRONIC 1216  
 AUDIOVOX 1417  
 BOSE 1256  
 CAMBRIDGE SOUNDWORKS 1397

CAPETRONIC 0558  
 CARVER 1116, 1216  
 CENTREX 1284  
 DENON 1387  
 FERGUSON 0558  
 FINE ARTS 1216  
 GRUNDIG 1216  
 HARMAN/KARDON  
 0137, 1331  
 INTEGRA 0162, 1325  
 JBL 0137, 1333  
 JVC 0101, 0558, 1401,  
 1522  
 1417, 1439  
 KENWOOD 1054, 1340  
 MCS 0066  
 MAGNAVOX 0558, 1116, 1216,  
 1296,  
 MARANTZ 0066, 1116, 1216,  
 1316  
 MICROMEGA 1216  
 MUSICMAGIC 1116  
 MYRYAD 1216  
 NAD 0347  
 NORCENT 1416  
 ONKYO 0162, 0869, 1325  
 OPTIMUS 0558, 1050  
 PANASONIC 0066, 1315, 1545,  
 1790  
 PHILIPS 1116, 1216, 1293,  
 1295, 1296, 1310,  
 1316  
 PIONEER 0041, 0558, 1050,  
 1411  
 POLK AUDIO 1316  
 PROSCAN 1281  
 QUASAR 0066  
 RCA 0558, 1050, 1281,  
 1417, 1636,  
 SABA 0558  
 SANSUI 1116  
 SCHNEIDER 0558  
 SONY 0185, 1085, 1185,  
 1685, 1785  
 STEREOPHONICS 1050  
 SUNFIRE 1340  
 TEAC 1417  
 TECHNICS 0066, 1335, 1336,  
 1545  
 TELEFUNKEN 0558  
 THOMSON 1281  
 THORENS 1216  
 UHER 0558  
 VENTURER 1417  
 VICTOR 0101  
 WARDS 0041, 0185  
 YAMAHA 0203, 1203, 1358,  
 2600, 2601, 2602,  
 2603, 2604, 2605

## SATELLITE TUNER

@SAT 1327  
 ABSAT 0150  
 ALBA 0482  
 ALPHASTAR 0799  
 AMSTRAD 0874  
 ASTON 0169, 1156  
 ASTRO 0200  
 ATSAT 1327  
 AVALON 0423

BLAUPUNKT 0200  
 BRITISH SKY BROADCASTING  
 0874, 1202  
 CANAL DIGITAL 0880  
 CANAL SATELLITE 0880  
 CANAL+ 0880  
 CHAPARRAL 0243  
 CITYCOM 1203  
 CONNEXIONS 0423  
 CROSSDIGITAL 1136  
 CYRUS 0227  
 D-BOX 0750, 1154  
 DMT 1102  
 DNT 0227, 0423  
 DAERYUNG 0423  
 DAEWOO 1323  
 DIGENIUS 0326  
 DIRECTV 0274, 0419, 0593,  
 0666, 0751, 0776,  
 0846, 1103, 1136,  
 1169, 1776, 1883  
 DISH NETWORK SYSTEM  
 0802, 1032  
 DISHPRO 0802, 1032  
 DISTRATEL 0111  
 DREAM MULTIMEDIA  
 1264  
 ECHOSTAR 0194, 0423, 0637,  
 0802, 0880, 0898,  
 1032, 1113  
 ENGEL 1044  
 EXPRESSVU 0802  
 FTE 0890  
 FINLUX 0482  
 FRACARRO 0898  
 FUBA 0423  
 GE 0593  
 GOI 0802  
 GALAXIS 0890, 1138  
 GENERAL INSTRUMENT  
 0896  
 GOLD BOX 0880  
 GRUNDIG 0200, 0874  
 HTS 0802  
 HIRSCHMANN 0200, 0423  
 HITACHI 0482, 0846  
 HUGHES NETWORK SYSTEM  
 0776, 1169, 1776  
 HUMAX 0890, 1203  
 INVIDEO 0898  
 JVC 0802  
 KATHREIN 0150, 0200, 0227,  
 0276, 0685, 1248  
 KREISELMEYER 0200  
 LABGEAR 1323  
 LOGIX 1044  
 LORENZEN 0326  
 MAGNAVOX 0749, 0751  
 MANHATTAN 0482, 1044,  
 1110  
 MARANTZ 0227  
 MEDIASAT 0880  
 MEMOREX 0751  
 METRONIC 0111  
 MITSUBISHI 0776  
 MOTOROLA 0896  
 MYRYAD 0227  
 NEXT LEVEL 0896  
 NOKIA 0482, 0750, 0778,  
 1154, 1250, 1750  
 OCTALTV 1032

ORBITECH 1127  
 PACE 0482, 0874, 1202,  
 1350  
 PANASONIC 0274, 0728, 0874,  
 1347  
 PANDA 0482  
 PAYSAT 0751  
 PHILIPS 0160, 0227, 0482,  
 0749, 0751, 0776,  
 0880, 1103, 1169,  
 1776  
 PIONEER 0880  
 PROMAX 0482  
 PROSCAN 0419, 0593  
 RCA 0170, 0419, 0593,  
 0882  
 RFT 0227  
 RADIOSHACK 0896  
 RADIOLA 0227  
 RADIX 0423  
 SKY 0874, 0883, 1202  
 SM ELECTRONIC 1227  
 SABRE 0482  
 SAGEM 0847, 1141, 1280  
 SAMSUNG 1044, 1136, 1303,  
 1319  
 SAT CONTROL 1327  
 SATSTATION 1110  
 SCHWAIGER 1138  
 SEEMANN 0423  
 SIEMENS 0200  
 SONY 0666, 0874, 1666  
 STAR CHOICE 0896  
 STRONG 1327  
 TPS 0847, 1280  
 TANTEC 0482  
 TECHNISAT 1126, 1127  
 TELESTAR 1127  
 THOMSON 0482, 0880, 1073,  
 1318  
 TOPFIELD 1233  
 TOSHIBA 0776, 0817, 1776  
 ULTIMATETV 0419, 0666  
 UNIDEN 0749, 0751  
 UNIVERSUM 0200  
 VENTANA 0227  
 WISI 0200, 0423, 0482  
 XSAT 0150  
 ZEHNDRER 1102  
 ZENITH 0883, 1883

## TAPE DECK

AIWA 0056  
 CARVER 0056  
 GRUNDIG 0056  
 HARMAN/KARDON  
 0056  
 MAGNAVOX 0056  
 MARANTZ 0056  
 MYRYAD 0056  
 OPTIMUS 0054  
 PHILIPS 0056  
 PIONEER 0054  
 POLK AUDIO 0056  
 RCA 0054  
 REVOX 0056  
 SANSUI 0056  
 SONY 0270  
 THORENS 0056  
 WARDS 0054  
 YAMAHA 2700, 2701

## TV

AGB 0543  
 AOC 0036, 0057, 0087,  
 0119, 0120, 0135,  
 0205, 0207, 0478  
 0131  
 ASA 0131  
 AWA 0036  
 ACURA 0036  
 ADDISON 0119, 0135, 0680  
 ADMIRAL 0120, 0190, 0490  
 ADVENT 0788  
 AIKO 0119  
 AKAI 0036, 0057, 0235,  
 0388, 0543, 0729,  
 0839  
 AKURA 0291  
 ALBA 0036, 0064, 0398,  
 0695  
 AMERICA ACTION 0207  
 AMPRO 0778  
 AMSTRAD 0036, 0064, 0198,  
 0398, 0439, 0460,  
 0543  
 ANAM 0036, 0207, 0277  
 ANAM NATIONAL 0277, 0677  
 ANITECH 0036  
 APEX DIGITAL 0775, 0792,  
 0794  
 AUDIOSONIC 0064, 0136  
 BANG & OLUFSEN 0592  
 BASIC 0036  
 BAUR 0064, 0388, 0539  
 BAYSONIC 0207  
 BEAUMARK 0205  
 BEKO 0397, 0513, 0741,  
 0742  
 BELL & HOWELL 0181  
 BEON 0064  
 BLAUPUNKT 0222  
 BLUE SKY 0695, 1064  
 BONDSTEC 0274  
 BRADFORD 0207  
 BRANDT 0136, 0362  
 BROKSONIC 0263, 0490  
 BUSH 0036, 0064, 0398,  
 0401, 0695, 1064  
 CCE 0064  
 CGE 0274  
 CTC 0274  
 CXC 0207  
 CANDLE 0057  
 CARNIVALE 0057  
 CARVER 0081, 0197  
 CASCADE 0036  
 CATHAY 0064  
 CELEBRITY 0027  
 CELERA 0792  
 CENTURION 0064  
 CHANGHONG 0792  
 CHING TAI 0036, 0119  
 CHUN YUN 0027, 0036, 0119,  
 0207  
 CHUNG HSIN 0080, 0135, 0207  
 CIMLINE 0036  
 CINERAL 0119, 0478  
 CITIZEN 0057, 0087, 0119  
 CLARION 0207  
 CLARIVOX 0064  
 CLATRONIC 0274, 0397  
 CONDOR 0347, 0397  
 CONRAC 0835

CONTEC	0036, 0207	GRANADA	0064, 0235, 0366,	MAGNADYNE	0274, 0543	PHILIPS	0027, 0057, 0064,
CRAIG	0207		0543	MAGNAFON	0543		0078, 0081, 0119,
CROSLEY	0081	GRANDIN	0637	MAGNAVOX	0057, 0081, 1281,		0135, 0205, 0401,
CROWN	0036, 0064, 0207,	GRUNDIG	0064, 0222, 0514,		1481		0583, 0717, 1481
	0397, 0445		0583, 0614	MANESTH	0291, 0347	PHONOLA	0064
CURTIS MATHES	0057, 0074,	GRUNPY	0207	MARANTZ	0057, 0064, 0081,	PILOT	0057
	0081, 0087, 0120,	HCM	0036, 0439		0583	PIONEER	0136, 0190, 0193,
	0172, 0181, 0193,	HALLMARK	0205	MARK	0064		0314, 0706, 0787,
	0478, 0729, 1174,	HANKOOK	0057, 0205, 0207	MATSUI	0036, 0064, 0235,		0893
	1374	HANSEATIC	0064, 0347, 0388,		0398, 0514, 0543	PORTLAND	0119
DAEWOO	0036, 0057, 0064,		0455, 0583	MATSUSHITA	0277, 0677	PRANDONI-PRINCE	0543
	0119, 0135, 0181,	HANTAREX	0543	MEDIATOR	0064		0788
	0197, 0205, 0207,	HARMAN/KARDON	0081	MEDION	0695, 0835, 1064	PRIMA	0788
	0401, 0478, 0650,	HARVARD	0207	MEGATRON	0172, 0205	PRISM	0078
	0661, 1688	HAVERMY	0120	MEMOREX	0036, 0177, 0181,	PROFEX	0036, 0388
DANSAI	0064	HELLO KITTY	0478		0205, 0277, 0490,	PROSCAN	0074
DAYTON	0036	HINARI	0036, 0064		1064	PROTECH	0036, 0064, 0274,
DE GRAAF	0235, 0575	HISAWA	0482	METZ	0474		0291, 0445, 0695
DECCA	0064, 0543	HITACHI	0036, 0057, 0119,	MICROMAXX	0835	PROTON	0036, 0057, 0205
DENON	0172		0132, 0136, 0172,	MICROSTAR	0835	PULSAR	0044
DIGATRON	0064		0190, 0205, 0252,	MIDLAND	0044, 0074, 0078	QUASAR	0078, 0277, 0677
DIXI	0036, 0064		0383, 0508, 0575,	MINERVA	0514	QUELLE	0064, 0131, 0388,
DUMONT	0044		0605, 1172, 1283	MINOKA	0439		0539
DWIN	0747, 0801	HUA TUN	0036	MITSUBISHI	0057, 0120, 0135,	R-LINE	0064
ECE	0064	HUANYU	0401		0177, 0181, 0205,	RCA	0027, 0057, 0074,
ELBE	0286	HYPSON	0064, 0291		0207, 0263, 0277,		0117, 0119, 0205,
ELECTROBAND	0027	ICE	0291, 0398		0539, 0863, 1277		0706, 1074, 1174,
ELIN	0064, 0575	ITS	0398	MIVAR	0318, 0319, 0543,		1274, 1374, 1474,
ELITE	0347	ITT	0190, 0388, 0575		0636		1481, 1574
ELTA	0036	IMPERIAL	0274, 0397, 0445	MOTOROLA	0120	RFT	0455
EMERSON	0181, 0205, 0207,	INDIANA	0064	MULTITECH	0036, 0207	RADIOSHACK	0057, 0074,
	0263, 0388, 0490,	INFINITY	0081	MYRYAD	0583		0181, 0205, 0207
	0650	INGELEN	0190	NAD	0183, 0205, 0388,	RADIOLA	0064
ENVISION	0057, 0840	INNO HIT	0543		0893	RADIOMARELLI	0543
EPSON	0860	INNOVA	0064	NEC	0036, 0057, 0078,	REALISTIC	0057, 0181, 0205,
ERRES	0064	INTEQ	0044		0181, 0183, 0197,		0207
ETHER	0036, 0057	INTERFUNK	0064, 0190, 0274,		0205, 0482, 0524,	REDIFFUSION	0388
ETRON	0036		0388, 0539		1731	REOC	0741
EUROPHON	0543	INTERVISION	0064, 0291,	NEI	0064	REVOX	0064
FERGUSON	0064, 0100, 0136,		0404	NTC	0119	REX	0190, 0286, 0291
	0265, 0314, 0362,	JBL	0081	NECKERMANN	0064, 0583	ROADSTAR	0036, 0291, 0445
	0587	JCB	0027	NETSAT	0064	RUNCO	0044, 0057, 0524,
FIDELITY	0388	JVC	0080, 0398, 0490,	NEWAVE	0036, 0119, 0120,		0630
FINLANDIA	0235, 0373		0680, 0710		0205	SBR	0064
FINLUX	0064, 0131, 0132,	JEAN	0036, 0078, 0119,	NIKKAI	0064, 0291	SEG	0291, 0695
	0373, 0543		0183, 0263	NIKKO	0057, 0119, 0205	SEI	0543
FIRSTAR	0036, 0263	JENSEN	0788	NOKIA	0388, 0500, 0507,	SKY	0064
FIRSTLINE	0036, 0274, 0695	KEC	0207		0575, 0658	SSS	0207
FISHER	0131, 0181, 0235,	KTV	0057, 0207	NORCENT	0775, 0851	SABA	0136, 0190, 0314,
	0397	KAISUI	0036	NORDMENDE	0136, 0314,		0362
FLINT	0482	KAPSCH	0190		0587	SACCS	0265
FORMENTI	0064, 0347	KARCHER	0637	OCEANIC	0190, 0388	SAGEM	0637
FORTRESS	0120	KATHREIN	0583	ONWA	0207, 0460	SAISHO	0036, 0291, 0543
FRONTECH	0190, 0274, 0291	KENDO	0064	OPTIMUS	0181, 0193, 0277,	SALORA	0190, 0380, 0388,
FUJITSU	0710, 0836	KENWOOD	0057		0677		0575
FUNAI	0207, 0198, 0291	KNEISSEL	0286, 0462	OPTONICA	0120	SAMBERS	0543
FUTURETECH	0207	KOLIN	0080, 0135, 0207	ORION	0064, 0263, 0347,	SAMPO	0036, 0057, 0119,
GE	0057, 0074, 0078,	KORPEL	0064		0490, 0543		0120, 0181, 0198,
	0119, 0205, 0207,	KOYODA	0036	OSAKI	0291, 0439		0205, 0677, 1782
	0478, 0587, 1174,	L&S ELECTRONIC	0835	OTTO VERSAND	0064, 0347,	SAMSUNG	0036, 0057, 0064,
	1374, 1481	LG	0057, 0064, 0087,		0539, 0583		0087, 0117, 0119,
GEC	0064, 0543		0135, 0205, 0741	PALLADIUM	0397, 0445		0181, 0205, 0291,
GATEWAY	1782, 1783	LXI	0074, 0081, 0181,	PANAMA	0291		0397, 0583, 0614,
GELOSO	0036		0183, 0205	PANASONIC	0064, 0078, 0081,		0645, 0729, 0793,
GENEXXA	0190	LEYCO	0064, 0291		0190, 0277, 0677,		0839, 0841
GIBRALTER	0044, 0057	LIESENK & TTER	0064		1437	SANSEI	0478
GOLDSTAR	0057, 0064, 0136,	LOEWE	0539	PATHE CINEMA	0265, 0347	SANSUI	0490
	0181, 0205, 0404	LUXOR	0383, 0388	PAUSA	0036	SANYO	0131, 0181, 0207,
GOODMANS	0064, 0398, 0401,	M ELECTRONIC	0036, 0064,	PENNEY	0057, 0074, 0078,		0235, 0366, 0826
	0661		0131, 0132, 0136,		0087, 0183, 0205,	SCHAUB LORENZ	0388
GOREMJE	0397		0190, 0314, 0373,		1374	SCHNEIDER	0064, 0274, 0398,
GRADIENTE	0080, 0197		0401, 0507	PERDIO	0347		0695
GRAETZ	0190, 0388	MGA	0057, 0177, 0205	PHILCO	0057, 0064, 0081,	SCOTCH	0205
		MTC	0057, 0087, 0539		0172, 0205, 0207,	SCOTT	0205, 0207, 0263
					0274, 0490, 1688		

SEARS	0074, 0081, 0181, 0183, 0198, 0205	UHER	0347	CRAIG	0064, 0074, 0099, 0267	KENWOOD	0068, 0094
SELECO	0190, 0286	UNIVERSUM	0064, 0131, 0132, 0291, 0373, 0397, 0519	CROWN	0099, 0305	KODAK	0062, 0064
SEMIVOX	0207			CURTIS MATHES	0062, 0068, 0087, 1062	KOLIN	0068, 0070 0099
SEMP	0183	VECTOR RESEARCH				KORPEL	
SHARP	0057, 0120, 0677		0057	CYBERNEX	0267	LG	0064, 0069, 0072, 0507
SHEN YING	0036, 0119	VESTEL	0064	CYRUS	0108	LXI	0064
SHENG CHIA	0036, 0120, 0263	VICTOR	0080, 0277, 0677, 0680	DAEWOO	0072, 0131, 0305, 0669, 1305	LENCO	0305
SIAREM	0543			DANSAI	0099	LEYCO	0099
SIEMENS	0064, 0222	VIDEOSAT	0274	DE GRAAF	0069	LLOYD'S	0027
SINUDYNE	0543	VIDIKRON	0081	DECCA	0027, 0108	LOEWE	0064, 0108, 1589
SKANTIC	0383	VIDTECH	0205	DENON	0069	LOGIK	0099, 0267
SKYGIANT	0207	VIEWSONIC	1782	DUAL	0068	LUXOR	0070, 0075, 0131
SKYWORTH	0064	VISION	0347	DUMONT	0027, 0108, 0131	M ELECTRONIC	0027
SOLAVOX	0190	VOXSON	0190	DYNATECH	0027	MEI	0062
SONITRON	0235	WALTHAM	0383	ESC	0267, 0305	MGA	0070, 0267
SONOKO	0036, 0064	WARDS	0057, 0081, 0205, 0893	ELCATECH	0099	MGN TECHNOLOGY	0267
SONOLOR	0190, 0235			ELECTROHOME	0064	MTC	0027, 0267
SONTEC	0064	WATSON	0064, 0347	ELECTROPHONIC	0064	MAGNASONIC	1305
SONY	0027, 0677, 0861, 1127, 1532, 1678	WAYCON	0183	EMEREX	0059	MAGNAVOX	0027, 0062, 0066, 0108, 1808
SOUNDESIGN	0205, 0207	WHITE WESTINGHOUSE	0064, 0347, 0490, 0650	EMERSON	0027, 0062, 0064, 0070, 0072, 0211, 0267, 0305, 1305, 1506	MAGNIN	0267
SOUNDWAVE	0064, 0445			FERGUSON	0068, 0347	MANESTH	0072, 0099
SOWA	0078, 0087, 0119, 0183, 0205	YAMAHA	0057, 0677, 0796, 0860, 2900 (projector), 2901 (projector), 2902, 2903	FIDELITY	0027	MARANTZ	0062, 0108
SQUAREVIEW	0198			FINLANDIA	0108, 0131	MARTA	0064
STANDARD	0036	YAPSHE	0277	FINLUX	0027, 0069, 0108, 0131	MATSUI	0375, 0379
STARLITE	0207	YOKO	0064, 0291	FIRSTLINE	0064, 0070, 0072, 0099	MATSUSHITA	0062
STERN	0190, 0286	ZENITH	0044, 0119, 0205, 0490	FISHER	0074, 0131	MEDION	0375
SUPREME	0027			FUJI	0060, 0062	MEMOREX	0027, 0062, 0064, 0066, 0074, 0075, 0131, 0267, 0334, 0375, 1264
SYLVANIA	0057, 0081, 0198			FUJITSU	0027, 0072	MEMPHIS	0099
SYMPHONIC	0198, 0207			FUNAI	0027	METZ	0064, 0374, 1589
SYNCO	0027, 0087, 0119, 0120, 0205, 0478			GE	0062, 0087, 0267, 0834, 1062, 1087	MINOLTA	0069
SYSLINE	0064			GEC	0108	MITSUBISHI	0068, 0070, 0094, 0108, 0834
T + A	0474			GARRARD	0027	MOTOROLA	0062, 0075
TCM	0835			GENERAL	0072	MULTITECH	0027, 0099
TMK	0205			GO VIDEO	0459	MURPHY	0027
TNCI	0044			GO VIDE	0459	MYRYAD	0108
TVS	0490			GOLDHAND	0099	NAD	0131
TACICO	0036, 0119, 0205			GOLDSTAR	0064, 0252, 0507, 1264	NEC	0062, 0064, 0068, 0075, 0094, 0131
TAI YI	0036			GOODMANS	0027, 0064, 0099, 0305	NATIONAL	0253
TANDY	0120, 0190			GRADIENTE	0027	NECKERMANN	0108
TASHIKO	0119, 0677			GRAETZ	0068, 0131, 0267	NESCO	0099
TATUNG	0036, 0064, 0078, 0081, 0087, 0181, 0183, 0543			GRANADA	0108, 0131	NEWAVE	0064
TEAC	0036, 0064, 0291, 0439, 0445, 0482, 0695, 1064			GRANDIN	0027, 0064, 0099	NIKKO	0064
TEC	0274			GRUNDIG	0099, 0108, 0253, 0374	NOBLEX	0267
TECHNEMA	0347			HCM	0099	NOKIA	0068, 0131, 0267
TECHNICS	0078, 0277, 0677			HI-Q	0074	NORDMENDE	0068, 0347
TECHWOOD	0078			HANSEATIC	0064	OCEANIC	0027, 0068
TECO	0036, 0078, 0119, 0120, 0205, 0291, 0680			HARLEY DAVIDSON	0027	OKANO	0342, 0375
TEKNIKA	0081, 0087, 0119, 0177, 0207			HARMAN/KARDON	0108	OLYMPUS	0062, 0253
TELEFUNKEN	0136, 0289, 0362, 0652, 0729			HARWOOD	0099	OPTIMUS	0064, 0075, 0131, 0459
TELEMEISTER	0347			HINARI	0099, 0267, 0379	ORION	0211, 0375, 0379, 1506
TELETECH	0036			HITACHI	0027, 0064, 0068, 0069, 0267	OSAKI	0027, 0064, 0099
TENSAI	0347			HUGHES NETWORK SYSTEMS	0069	OTTO VERSAND	0108
TERA	0057					PALLADIUM	0064, 0068, 0099
THOMSON	0136, 0314, 0587, 0652, 1474					PANASONIC	0062, 0252, 0253, 0643, 1062, 1589
THORN	0064, 0131, 0388, 0539					PATHE MARCONI	0068
TOSHIBA	0087, 0181, 0183, 0535, 0645, 0677, 0859, 1283, 1383, 1683, 1731					PENNEY	0062, 0064, 0069, 0267, 1062, 1264
TRIUMPH	0543					PENTAX	0069
TUNTEX	0036, 0057, 0119					PERDIO	0027
						PHILCO	0062
						PHILIPS	0062, 0108, 0645, 1108, 1208
						PHONOLA	0108
						PILOT	0064

### VCR

ASA	0064, 0108
ADMIRAL	0075
ADVENTURA	0027
AIKO	0305
AIWA	0027, 0064, 0334, 0375, 0379
AKAI	0068, 0342
AKIBA	0099
ALBA	0099, 0305, 0342, 0379
AMERICA ACTION	0305
AMERICAN HIGH	0062
AMSTRAD	0027
ANAM	0064, 0253, 0267, 0305, 0507
ANAM NATIONAL	0253, 1589
ANITECH	0099
ASHA	0267
ASUKA	0064
AUDIOVOX	0064, 0305
BAIRD	0027, 0068, 0131
BASIC LINE	0099, 0305
BEAUMARK	0267
BELL & HOWELL	0131
BLAUPUNKT	0253
BRANDT	0347
BRANDT ELECTRONIC	0068
BROKSONIC	0211, 0375, 1506
BUSH	0099, 0305, 0379
CCE	0099, 0305
CGE	0027
CALIX	0064
CANON	0062
CARVER	0108
CIMLINE	0099
CINERAL	0305
CITIZEN	0064, 0305, 1305
COLT	0099
COMBITECH	0379

PIONEER	0069, 0094, 0108	TELEFUNKEN	0068, 0347
POLK AUDIO	0108	TENOSAL	0099
PROFITRONIC	0267	TENSAI	0027
PROLINE	0027	THOMAS	0027
PROSCAN	0087, 1087	THOMSON	0068, 0087, 0094, 0347
PROTEC	0099	THORN	0068, 0131
PULSAR	0066	TIVO	0645, 0663
PYE	0108	TOSHIBA	0068, 0070, 0072, 0094, 0108, 0872
QUASAR	0062, 1062	TOTEVISION	0064, 0267
QUELLE	0108	UHER	0267
RCA	0062, 0069, 0087, 0267, 0834, 1062, 1087	UNITECH	0267
RADIOSHACK	0027	UNIVERSUM	0027, 0064, 0108, 0267
RADIOLA	0108	VECTOR	0072
RADIX	0064	VICTOR	0068, 0094
RANDEX	0064	VIDEO CONCEPTS	0072
REALISTIC	0027, 0062, 0064, 0074, 0075, 0131	VIDEOMAGIC	0064
REOC	0375	VIDEOSONIC	0267
REPLAYTV	0641, 0643	VILLAIN	0027
REX	0068	WARDS	0027, 0062, 0069, 0074, 0075, 0087, 0099, 0108, 0267
ROADSTAR	0064, 0099, 0267, 0305	WHITE WESTINGHOUSE	0099
RUNCO	0066	XR-1000	0027, 0062, 0099
SBR	0108	YAMAHA	0068
SEG	0267	YAMISHI	0099
SEI	0108	YOKAN	0099
STS	0069	YOKO	0267
SABA	0068, 0347	ZENITH	0027, 0060, 0066, 1506
SALORA	0070		
SAMPO	0064, 0075		
SAMSUNG	0072, 0267, 0459		
SANKY	0066, 0075		
SANSUI	0027, 0068, 0094, 1506		
SANYO	0074, 0131, 0267		
SAVILLE	0379		
SCHAUB LORENZ	0027, 0068, 0131		
SCHNEIDER	0027, 0099, 0108		
SCOTT	0070, 0072, 0211		
SEARS	0027, 0062, 0064, 0069, 0074, 0131, 1264		
SELECO	0068		
SEMP	0072		
SHARP	0075, 0834		
SHINTOM	0099, 0131		
SIEMENS	0064, 0108, 0131		
SILVA	0064		
SINGER	0072, 0099		
SINUDYNE	0108		
SONIC BLUE	0641, 0643		
SONTEC	0064		
SONY	0027, 0059, 0060, 0062, 0663, 1259		
SUNKAI	0375		
SUNSTAR	0027		
SUNTRONIC	0027		
SYLVANIA	0027, 0062, 0108, 0070, 1808		
SYMPHONIC	0027		
TMK	0267		
TANDY	0027, 0131		
TASHIKO	0027, 0064		
TATUNG	0027, 0068, 0072, 0094, 0108		
TEAC	0027, 0068, 0305, 0334, 0669		
TECHNICS	0062, 0253		
TECO	0062, 0064, 0068, 0075		
TEKNIKA	0027, 0062, 0064		
TELEAVIA	0068		



© 2005 YAMAHA CORPORATION All rights reserved.

**YAMAHA ELECTRONICS CORPORATION, USA** 6660 ORANGETHORPE AVE., BUENA PARK, CALIF. 90620, U.S.A.  
**YAMAHA CANADA MUSIC LTD.** 135 MILNER AVE., SCARBOROUGH, ONTARIO M1S 3R1, CANADA  
**YAMAHA ELECTRONIK EUROPA G.m.b.H.** SIEMENSSTR. 22-34, 25462 RELLINGEN BEI HAMBURG, GERMANY  
**YAMAHA ELECTRONIQUE FRANCE S.A.** RUE AMBROISE CROIZAT BP70 CROISSY-BEAUBOURG 77312 MARNE-LA-VALLEE CEDEX02, FRANCE  
**YAMAHA ELECTRONICS (UK) LTD.** YAMAHA HOUSE, 200 RICKMANSWORTH ROAD WATFORD, HERTS WD18 7GQ, ENGLAND  
**YAMAHA SCANDINAVIA A.B.** J A WETTERGRENS GATA 1, BOX 30053, 400 43 VÄSTRA FRÖLUNDA, SWEDEN  
**YAMAHA MUSIC AUSTRALIA PTY, LTD.** 17-33 MARKET ST., SOUTH MELBOURNE, 3205 VIC., AUSTRALIA

**YAMAHA CORPORATION**  
Printed in Malaysia © WF99990-2