

YAMAHA

TX816
TX216

FM TONE GENERATOR SYSTEM

OPERATIONS DIRECTORY

HOW TO USE THIS OPERATIONS DIRECTORY

We suggest that you first read the Owner's Manual, while familiarizing yourself with the main features of your Yamaha TX816/TX216/TF1 FM Tone Generator System. The Owner's Manual gives you a thorough hands-on introduction to this powerful FM Tone Generator, and details all the modes and sub-modes of operation, together with various system examples.

The aim of this Operation Directory is to list in concise form, using mainly visual representations, all the operations that can be carried out on the TX816. Once you have acquainted yourself with the TX816, you can refer to this directory for quick reminders, so that you can use the TX816 efficiently and easily without having to read through masses of technical information in the middle of a session.

You can find that you need in two ways: 1. In that CONTENTS, where the main modes and applications of the TX816 are listed, or 2. In the INDEX, where all modes and sub-modes are listed, and operations are often listed under more than one name (for example, "keyboard splitting" and "Limit highest key", which refer to the same operation).

The CONVENTIONS section describes the various symbols used in this directory (wherever we can we have used symbols that are exact reproductions of actual controls on the TX816 and other Yamaha MIDI instruments). We then explain the four main modes of the TX816: PLAY, EDIT, STORE and UTILITY, and their fourteen sub-modes.

This is followed by explanations of the specific operations that apply when using the TX816 with a DX7 synthesizer, a QX1 Digital Sequence Recorder, and a CX5M Music Computer. And finally . . . the indispensable INDEX.

CONTENTS

HOW TO USE THIS OPERATIONS DIRECTORY	1
CONVENTIONS	3
1. THE PLAY MODE	
1-1. DX7 Connected to COMMON MIDI IN	4
1-2. DX7 Connected to INDIVIDUAL MIDI IN	4
1-3. Setting the MIDI Channel	4
1-4. Turning the Omni Mode ON/OFF	4
1-5. Tuning Master Pitch of TF1	4
2. THE EDIT MODE	
2-1. Selecting a Program for Editing	5
2-2. Adjusting the Output Level	5
2-3. Setting the Lowest Key Limit	5
2-4. Setting the Highest Key Limit	5
3. THE STORE MODE	
3-1. Entering the Store Mode	6
3-2. Selecting a Store Destination	6
3-3. Storing Voice and Function Data	6
3-4. Storing Function Data Only	6
4. THE UTILITY MODE	
4-1. Dumping All Voices and Functions	7
4-2. Clearing & Initializing All Functions	7
4-3. Audio Check Signal	7
4-4. Checking the Battery Level	8
5. DX7 APPLICATIONS	
5-1. Dumping All Voice Data Into a DX7	9
5-2. Loading All Voice Data From a DX7	9
5-3. Loading Data of A Single Voice From a DX7 . .	9
6. QX1 APPLICATIONS	
6-1. Dumping Voice and/or Function Data Into a QX1	10
6-2. Loading Data From a QX1	10
7. CX5M APPLICATIONS	
7-1. The FM Music Composer System	12
7-2. Editing With the DX7 Voicing Program	12
7-3. Checking TF1 Voice Parameters with the CS5M	13
7-4. Loading the Data of One Voice from the CX5M	13
7-5. Loading the Data of 32 Voices From the CS5M	13
7-6. Dumping the Data of 32 Voices From the TX816 into the CX5M	14
INDEX	15

CONVENTIONS

The following conventions and symbols are used to make this Operations Directory easier and quicker to read.

We'll assume that you have thoroughly familiarized yourself with the CONVENTIONS chapter in the TX816 Owner's Manual, because we'll be using the same conventions here, along with a few others. As with the Owner's Manual, we'll only mention the TX816 throughout the text.

We'll also generally assume that the basic system of TX816 plus DX7 is being used (see the SETTING UP chapter in the Owner's Manual), although the majority of operations will be applicable when using the TX816 with any other MIDI instrument.

Any references to an Owner's Manual will use the abbreviation O.M.

Certain operations on the DX7 (such as setting it to SYS INFOR AVAIL) or QX1 or CX5M will not be fully explained, as we'll assume that you already know how to do them. If in doubt, consult the appropriate O.M.

Within each operation we will generally give the limits of any numerical data (for example, the Attenuate Output Level sub-mode has a range of 0 - 7) so that you know at a glance how much range is available to you.

At the end of each description of an operation, we will inform you how to reset the TX816 to its main mode of operation, although you can take it as a general rule that pressing SW3 once will move you on to the next sub-mode.

If the LED Display on your TX816 shows an Error Display, consult the corresponding section in the O.M.

The following general symbols will be used.



Means "you will then see . . .". If you are holding down a switch, it means "release the switch when you see . . .".

.....

Means "go on to the next symbol or operation". If there are two or more options, the dotted line will divide accordingly.

The following symbols and conventions apply to the TX816.



Means "press SW1, SW2 or SW3".



Means "hold down SW1, SW2 or SW3" (typically until you see the next LED Display illustrated, at which point you release the key).



Means an LED is lit or has flashed.



Means an LED has turned off.

The following symbols and conventions apply to the DX7 Programmable Algorithm Synthesizer.

DATA ENTRY

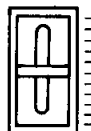

The Data Entry Lever, which can generally raise or lower any voice or function parameters, including those applying to features that exist only in a TF1, such as Tune Master Pitch or Attenuate Output Level. Unless otherwise indicated, the DX7 does not have to be switched to any particular mode in order for its Data Entry Lever to affect the TX816 as described.

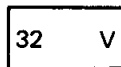

Signifies "any voice select key". We'll use number 32 unless another number is appropriate.

For the CX5M Music Computer and QX1 Digital Sequence Recorder, the conventions used are easy to understand and are described in the corresponding O.M.'s.

1. THE PLAY MODE

The TX816 automatically enters the Play Mode when first turned on. It is immediately ready to play. Select a program number (range 1 - 32) by pressing a voice select key on DX7.

NOTE:

DX7 must be set to SYS INFO UNAVAIL.

1-1. DX7 Connected to COMMON MIDI IN

(see Basic System in O.M.)

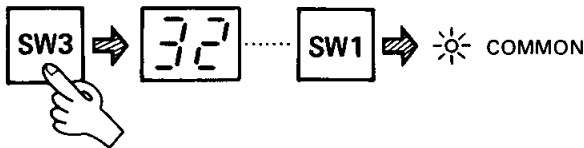

1-2. DX7 Connected to INDIVIDUAL MIDI IN

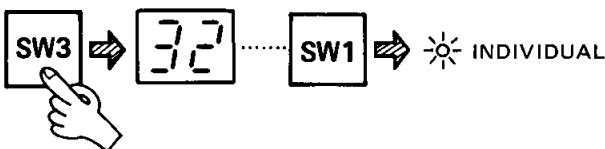

1-3. Setting the MIDI Channel (range 1 - 16)

(Set the TF1 to the same channel as the MIDI device that is transmitting data).

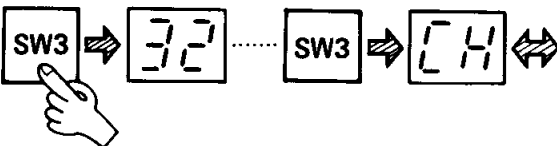

(If a dot appears, the Omni Mode is ON. See Operation 1-4.)

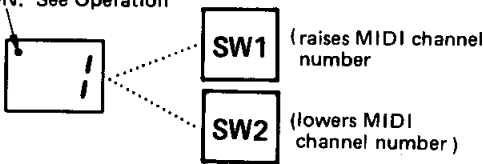

++ Returning to the Play Mode



1-4. Turning the Omni Mode ON/OFF

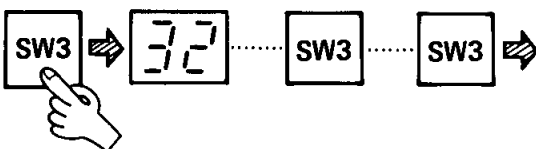

(dot indicates Omni Mode ON)

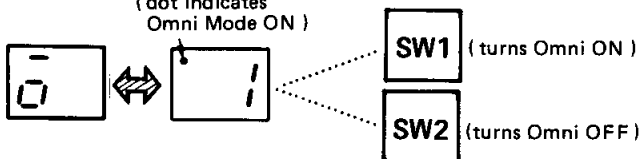

++ Returning to the Play Mode



1-5. Tuning Master Pitch of TF1

(range -63 to +64; each increment = 1.2 cents)

Zero setting = concert pitch (A = 440 Hz)

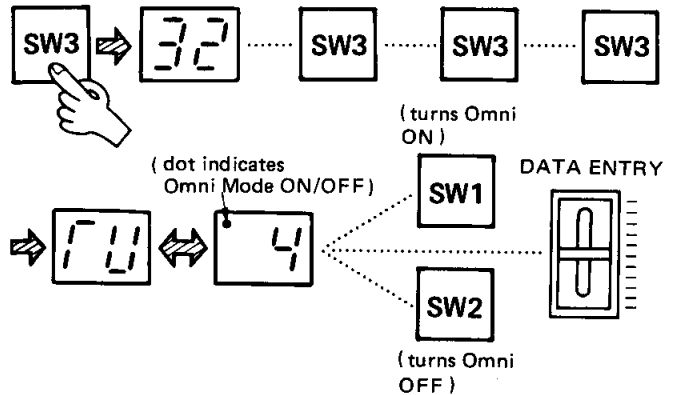

NOTE:

DX7 data entry lever tunes TF1 ONLY. However, if you set the DX7 to the MASTER TUNE ADJ function, any movement of the Data Entry Lever will instantly tune the TF1 to the DX7, and they may then be tuned simultaneously.

++ Returning to the Play Mode



2. THE EDIT MODE

2-1. Selecting a Program for Editing (range 1 - 32)

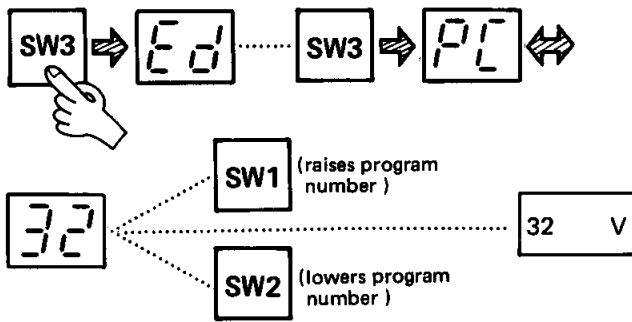

NOTE:

For editing, set DX7 to SYS INFO AVAIL, INTERNAL MEMORY OFF, MIDI Channel to match MIDI channel setting on TF1.

IMPORTANT:

Have only the module(s) you wish to edit switched to "COMMON". Other modules should be switched to "INDIVIDUAL".

++ Returning to the Edit Mode



2-2. Adjusting the Output Level (range 0 - 7)

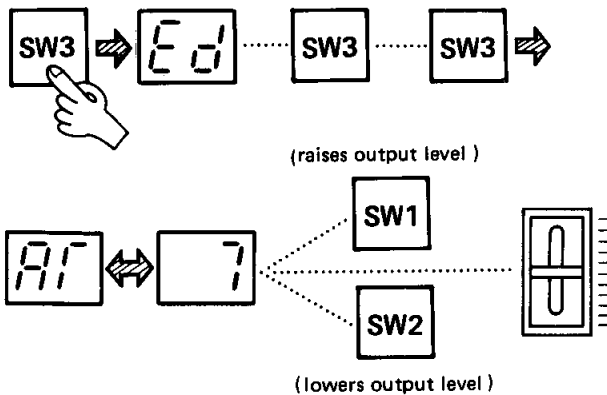

++ Returning to the Edit Mode

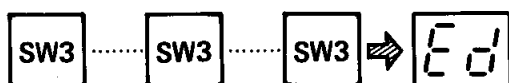

2-3. Setting the Lowest Key Limit (range C-2 - G8)

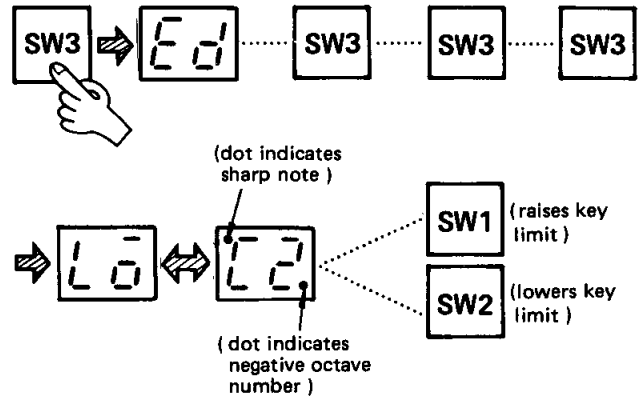

++ Returning to the Edit Mode



2-4. Setting the Highest Key Limit (range c-2 - G8)

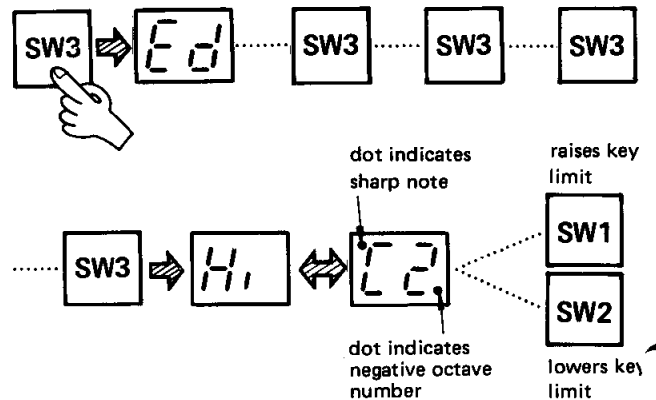

++ Returning to the Edit Mode



3. THE STORE MODE

Unlike most of the other sub-modes on the TX816, the sub-modes within the Store Mode are used in sequence rather than as separate, independent operations.

Two operations are possible in the Store Mode: Storing Voice and Function Data, or Storing Function Data Only. The first two stages of these operations (turning the Memory Protect off, and selecting a Store Destination) are identical, so we'll describe them now.

3-1. Entering the Store Mode and Turning the Memory Protect OFF

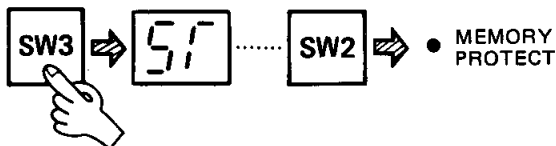

3-2. Selecting a Store Destination (range 1 - 32)

(first carry out operation 3-1)

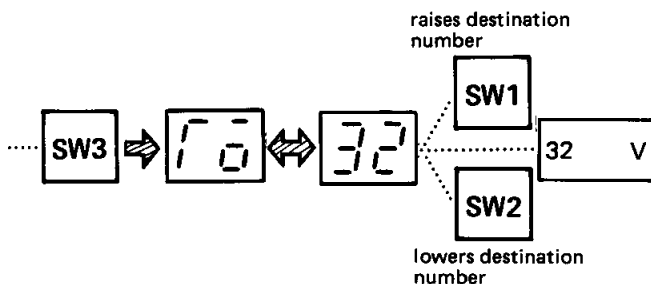

3-3. Storing Voice and Function Data

(first carry out operations 3-1 and 3-2)

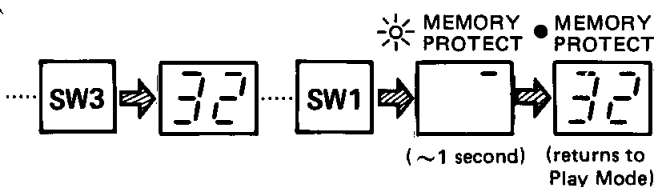

Then turn Memory Protect ON



3-4. Storing Function Data Only

(first carry out operations 3-1 and 3-2)

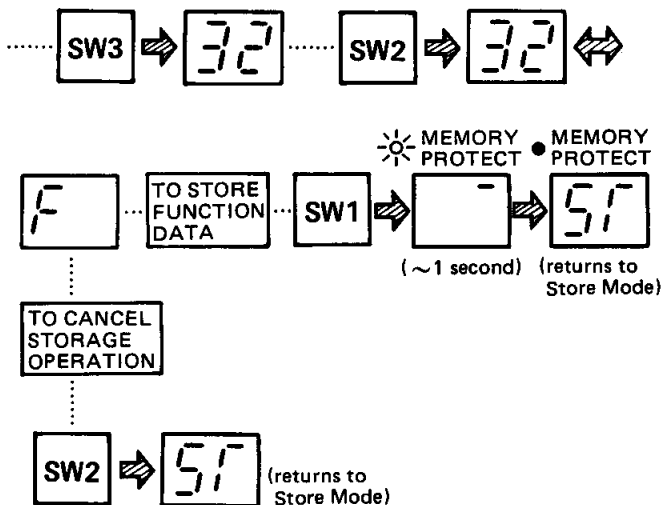

After returning to Store Mode, turn Memory Protect ON
Or you can store function data to another destination (return to operation 3-2)



4. THE UTILITY MODE

4-1. Dumping All Voices and Functions

We'll describe here the procedure for dumping voices and functions from one TF1 to another. The procedure for dumping into a DX7, QX1 or CX5M is described in the corresponding chapters that follow, and does not necessarily require that the TF1 be switched to the Utility Mode.

Assuming that you wish to dump data from module 1 to module 2:

Connect COMMON MIDI OUT to module 2 MIDI IN.

Set module 2 as follows (it can be in any mode).

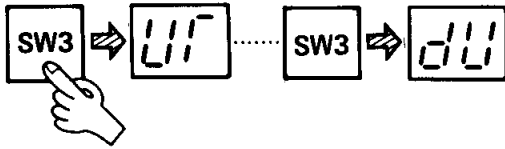

Set module 1 as follows.

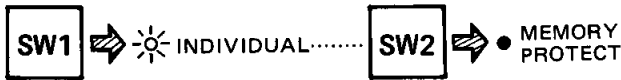

Then use OUT SLOT SELECT key (range 1 - 8) to select module number 1.

To dump from module 1

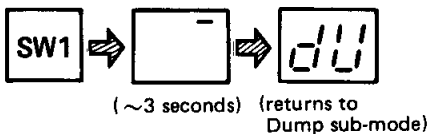

During the 3-second dump process, module 2 will show the following indications (we'll assume that module 2 is in the Play Mode)

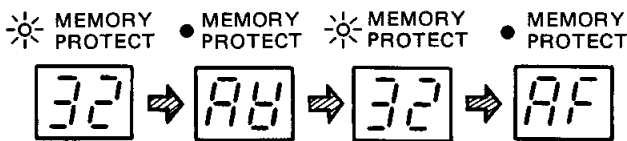

Reset Module 2's LED Display then turn its Memory Protect ON.

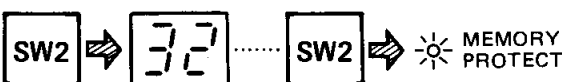

++ Returning Module 1 to the Utility Mode



4-2. Clearing & Initializing All Functions

This operation clears and initializes all functions in the TF1. The corresponding section in the UTILITY MODE chapter of the O.M. contains a chart showing all the functions, and their initial values.

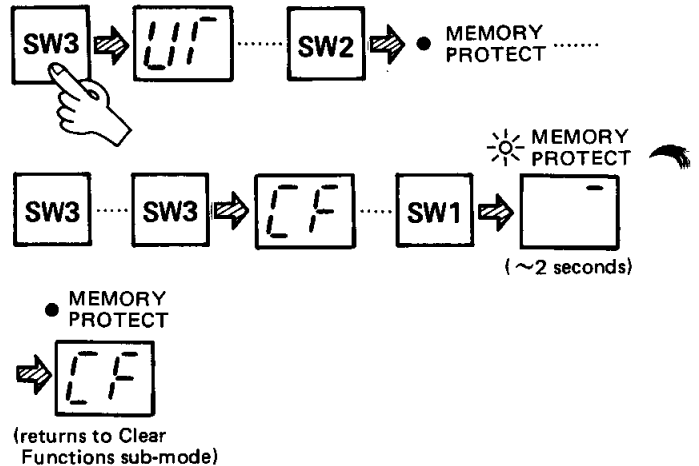

++ Returning to the Utility Mode

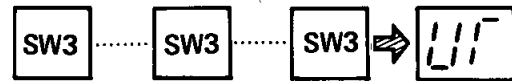

Then turn Memory Protect ON.



4-3. Audio Check Signal

This gives a standard concert pitch (440 Hz) sine tone at -4 dBm.

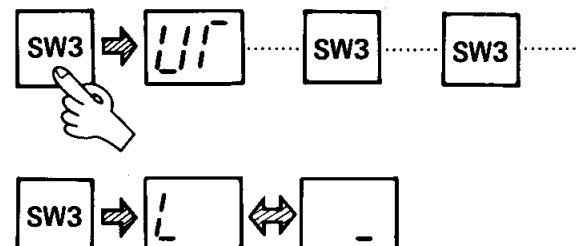

To turn Audio Check Signal ON



To turn Audio Check Signal OFF



++ Returning to the Utility Mode



4-4. Checking the Battery Level

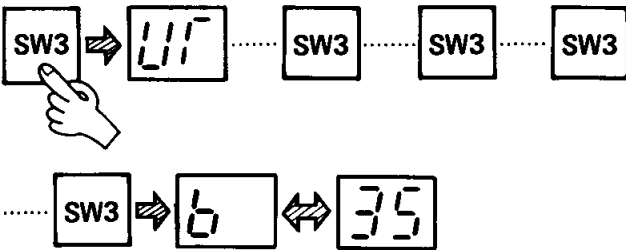

The LED Display number is ten times the voltage. For example "35" 3.5 volts.

IMPORTANT:

If the battery level is 2.2 volts or less, it needs replacing immediately. Contact the store where you purchased your TX816, or your nearest Yamaha Service Station.

++ Returning to the Utility Mode



5. DX7 APPLICATIONS

We'll assume that you are using the Basic System as described in the SETTING UP chapter of the O.M.

5-1. Dumping All Voice Data Into a DX7

NOTE:

You can only dump voice data, NOT function data into the internal memory of a DX7.

Set the DX7 to SYS INFO AVAIL, Internal Memory Protect OFF, and MIDI Channel 1 (the TX816 always dumps data via MIDI Channel 1).

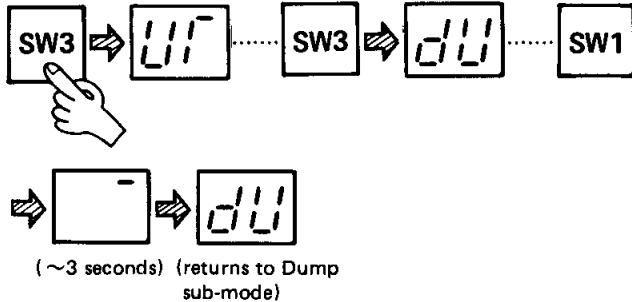

The DX7's LCD will show "MIDI RECEIVED". If it shows "MIDI DATA ERROR" there has been an error in the setting of the DX7 and you should follow the above procedure once again.

++ Returning to the Utility Mode



5-2. Loading All Voice Data From a DX7

For each module that you want to receive the data of the 32 voices stored in the DX7's internal memory, set as follows (they can be in any mode)

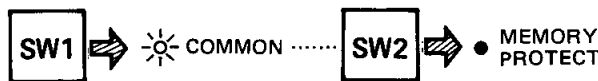

Set the DX7 to SYS INFO AVAIL, call up the MIDI TRANSMIT ? function, and press the YES/ON key.

YES

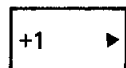

ON

During loading, each TF1 will display the following (we'll assume that the modules are in the Play Mode)

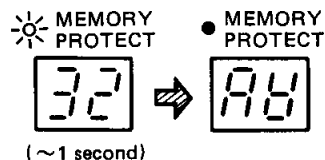

Reset each module's LED Display then turn its Memory Protect ON.

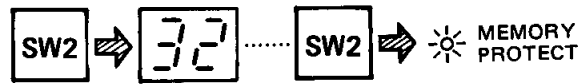

5-3. Loading Data of a Single Voice From a DX7

This loads the voice data (NOT function data) of a single voice from the DX7's Edit Buffer into the TF1's Edit Buffer. You can select a voice from the DX7's Internal memory, or from a RAM Cartridge.

Set TF1 to "COMMON" (it can be in any mode)



Set the DX7 to SYS INFO AVAIL, and ensure that it is set to the same MIDI Channel as the TF1.

To load voice into TF1

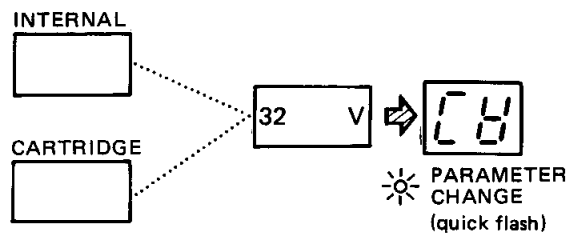

To reset the LED Display (assuming TF1 was in Play Mode)



The DX7 voice is now in the TF1's Edit Buffer, where it can be played, edited, or stored in the TF1's Internal Memory.

6. QX1 APPLICATIONS

Connect QX1 MIDI OUTS 1 thru 8 to TX816 INDIVIDUAL MIDI INS 1 thru 8.

Connect QX1 MIDI IN to TX816 COMMON MIDI OUT.

Set all TF1 modules to "INDIVIDUAL". They can be in any mode.



6-1. Dumping Voice and/or Function Data Into a QX1

Carry out the operations described at the beginning of this chapter.

Then use OUT SLOT SELECT key (range 1 - 8) to select number of module from which you wish to dump.

Now carry out the following operations on the QX1.

(a) Press [UTLT]. The LCD will show "UTILITY MODE".

(b) Press [JOB COMMAND]. The LCD will show "JOB COMMAND SELECT".

(c) Type in "21". Press [ENTER]. The LCD will show "BULK IN".

(d) Type in the following four data entries.

1. BULK number (range 01 - 16)
2. TERMINAL number (range 1 - 8) corresponding to the TF1 module number.
3. Set channel for dump request from QX1 Match to TF1 MIDI Channel.
4. FORMAT: any of the following four numbers:

000

to dump voice data of a single program

001

to dump function data of a single program

002

to dump function data of all 32 programs

009

to dump voice data of all 32 programs

(e) Hit [ENTER]. If the bulk destination you have selected was empty the LCD will show "BULK NAME SET". Go straight to paragraph (h).

(f) If the bulk destination you have selected already contains data, the LCD will show the flashing "SURE ? YES(Y)/NO(N)" message.

If you do not wish to lose the data already stored in the bulk destination, press [N] while holding down [SHIFT ▼]. The LCD will return to the "UTILITY MODE" message. Return to paragraph (b) and repeat the procedure for selecting a different bulk destination.

(g) If you wish to erase the existing data in the bulk destination and store the new data, press [Y] while holding down [SHIFT ▼]. The LCD will show "BULK NAME SET".

(h) Type in a bulk name – up to 8 letters, numbers, and/or spaces.

(i) Press [ENTER]. The LCD will now show the flashing "EXECUTING NOW !!" message for a few seconds, while the data is transmitted. It will then return to the "UTILITY MODE" display.

(j) During the data transmission, the INDIVIDUAL LED on the TF1 will go out.

(k) After the data transmission, the TF1's INDIVIDUAL LED will light up, and its LED Display will show one of the four following displays.

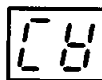

(1 voice data sent)

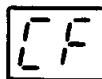

(1 function data sent)



(32 function data sent)



(32 voice data sent)

Reset the LED Display by pressing SW2.

The data is now stored on the QX1's floppy disk. As it contains 16 bulk destinations, the floppy disk can store all the voice and function data of the TX816 (8 sets of voice data plus 8 sets of function data). Simply repeat the above operation for all modules, typing in the appropriate terminal number and format number in paragraph (d).

6-2. Loading Data From a QX1

Connect the equipment and carry out the operations described at the beginning of this chapter.

Turn OFF the Memory Protect of the module that will be receiving the data.



Carry out the following operations on the QX1.

- (a) Press [UTLT]. The LCD will show "UTILITY MODE".
- (b) Press [JOB COMMAND]. The LCD will show "JOB COMMAND SELECT".
- (c) Type in "22" and press [ENTER]. The LCD will show "BULK OUT".
- (d) Type in the bulk number (range 01 - 16) and the terminal number (range 1 - 8) corresponding to the TF1 module number. Ignore the "WAIT" section.
- (e) Press [ENTER]. The LCD will show the flashing "SURE ? YES(Y)/NO(N)" message.
- (f) If you've changed your mind and do NOT wish to load the selected bulk data, press [N] while holding down [SHIFT]. The LCD will return to the "UTILITY MODE" message. Return to paragraph (b) above if you wish to select different bulk data.
- (g) If you do wish to load the bulk data into the TF1, press [Y] while holding down [SHIFT ▼]. The LCD will show the flashing "EXECUTING NOW !!" message for a few seconds, while data is transmitted. It will then return to the "UTILITY MODE" display.
- (h) During data transmission the TF1 Memory Protect LED will light.
- (i) After data transmission the TF1 Memory Protect LED will go out, and its LED Display will show, depending on the data received, one of the following four display.

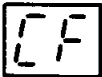

(1 function data sent)

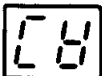

(1 voice data sent)



(32 function data sent)

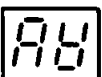

(32 voice data sent)

- (j) Then reset the LED Display (we'll assume the TF1 was in the Play Mode) and turn on the Memory Protect.

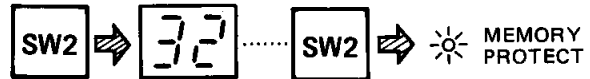

NOTE:

It is possible to load data from the QX1 into any or all of the TX816's modules simultaneously, as follows.

Connect QX1 MIDI OUT 1 to TX816 COMMON MIDI IN.

Set to "COMMON" all TF1 modules that you wish to receive data, and turn OFF their Memory Protects. They can be in any mode.

Carry out the QX1 operations exactly as described above. In paragraph (d), type in terminal number 1, as this is the QX1 terminal that is connected to the TX816.

7. CX5M APPLICATIONS

7-1. The FM Music Composer System

These are the instructions for playing an eight-part composition through the TX816, instead of using the CX5M's built-in FM Tone Generator. You will, of course, need the Yamaha FM Music Composer Program Cartridge. We'll assume that you have already composed a complete piece of music with eight parts.

- Connect CX5M MIDI OUT to TX816 COMMON MIDI IN.
- Set all modules to "COMMON".



- Set each module to the MIDI Channel number corresponding to its module number.

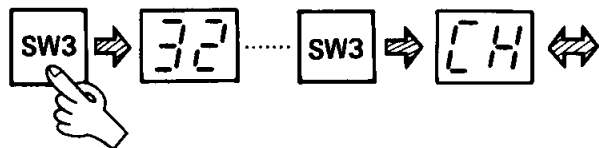

(If a dot appears, the Omni mode is on.)

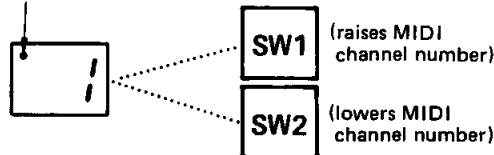

- If any module has its Omni mode switched ON, it MUST be switched OFF. See operation 1-4.
- Reset all modules to the Play Mode.

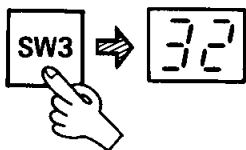

- Insert a MIDI Channel number at the beginning of each part in your FM Music composition. The MIDI Channel number should correspond to the part number. The FM Music Composer Program O.M. tells you how to do this.
- When you play back your composition, Part 1 of your composition will be played via module 1, Part 2 via module 2, etc.
- A variation on this to insert different MIDI Channel numbers in your FM Music Program, so that one

TX816 module could play several parts of the composition, with the same FM voice. Alternatively, any module set to Omni ON will play all eight parts of the composition. And, of course, you can insert MIDI Channel numbers anywhere in your composition so that parts can switch voices.

7-2. Editing With the DX7 Voicing Program

This system requires a DX7 as well as a TX816 and CX5M, plus the Yamaha DX7 Voicing Program. You can edit any TF1 voice, while watching the parameters displayed visually on a video monitor, then store the newly-edited voice in the TX816's internal memory.

- Before making any MIDI connections, make sure that the power to all the equipment is OFF. Then insert the DX7 Voicing Program Cartridge into the CX5M.
- Connect the TX816 COMMON MIDI IN to the DX7 MIDI OUT.
- Connect the TX816 COMMON MIDI THRU to the CX5M MIDI IN.
- Connect the CX5M MIDI OUT to the DX7 MIDI IN.
- Turn on the power to the equipment in the following order: DX7, TX816, CX5M.
- Set the DX7 to SYS INFO AVAIL.
- Set to "COMMON" the TF1 module that you wish to edit.



- Set the same module to the Select Program Number For Edit sub-mode, and select the number of the program you wish to edit.

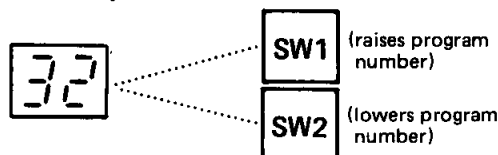
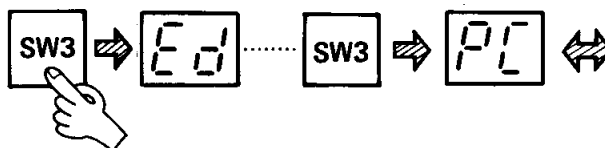

- (i) Press [F1] on the CX5M. The screen display will switch from Voice Directory to Voice Edit, and will show the parameters of the voice you wish to edit. (See DX7 Voicing Program O.M. for details).
- (j) Commence editing on the DX7. You'll see the parameters changing on your video screen.
- (k) Once you have edited a voice, you can store the new data in the TF1's internal memory. See operation 3 (Store Mode).

7-3. Checking TF1 Voice Parameters with the CX5M

- (a) BEFORE turning on the CX5M power, insert the DX7 Voicing Program Cartridge.
- (b) Connect the MIDI OUT of the CX5M to the COMMON MIDI IN of the TX816.
- (c) Connect the COMMON MIDI OUT of the TX816 to the MIDI IN of the CX5M.
- (d) Turn on the power to the CX5M, then the TX816.
- (e) Set to "COMMON" the TF1 module that you are working with.



- (f) Set the same module to the Select Program Number For Edit sub-mode, and select the number of the program you wish to check.

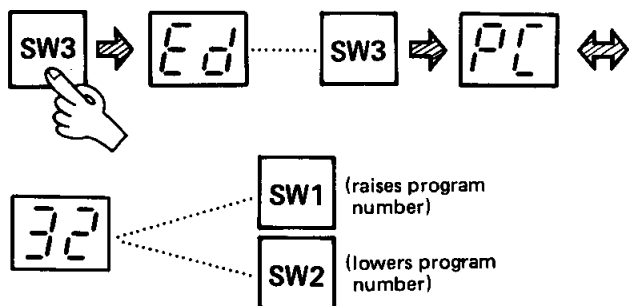

- (g) Press [F1] on the CX5M. The screen display will switch to Voice Edit, and will show the parameters of the voice you wish to check.

NOTE:

The DX7 Voicing Program was not designed for use with the TX816, so the difference in formatting means that you can check only voice data in this way, NOT function data.

- (h) Press SW1 or SW2 to select other voices for checking. Their voice parameters will be displayed on your video screen.

7-4. Loading the Data of One Voice From the CX5M

First carry out the operations described in paragraphs (a) thru (e) of operation 7-3.

- (a) Press [F5] on the CX5M, to select the PLAY function.
- (b) Type in the number of the voice you wish to load.
- (c) Press [RETURN]. On the TF1, the green Parameter Change LED will flash, and you'll see the following LED Display.

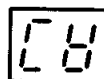

- (d) The voice and function data is now in the TF1's Edit Buffer, available for storing, playing, or editing. Reset the LED Display by pressing SW2.

7-5. Loading the Data of 32 Voices From the CX5M

NOTE:

Function data can NOT be transmitted to the TF1 with this operation -- it can only be transmitted when loading one voice at a time -- see operation 7-4.

First carry out the operations described in paragraphs (a) thru (e) of operation 7-3.

- (a) Turn the TF1 Memory Protect OFF.



- (b) On the CX5M, press [F2] while holding down [SHIFT], to select the "Midi Ch=" display. If the MIDI Channel is the same as the one the TF1 is set to, go straight on to paragraph (d). If not, go on to the next paragraph.

- (c) Type in the number corresponding to the MIDI Channel the TF1 is set to, and press [RETURN]. Then press [F2] while holding down [SHIFT].
- (d) Press [SELECT] twice to get the "MIDI Tfr to DX7?" screen display.
- (e) Press [DEL] to get the "Are You Sure ?" screen display, then press the same key again to load the voice data.
- (f) During the 2 second loading process, the TF1's Memory Protect LED will light up.
- (g) After the loading process, the TF1's Memory Protect will go out again, and you'll see the following LED Display.



- (h) Reset the LED Display and turn the Memory Protect ON. (As usual, we'll assume that the TF1 was in the Play Mode).



- (c) On the CX5M, Press [F1] to get the Directory display, then press [F2] while holding down [SHIFT], then press [SELECT] to get the "MIDI Tfr from DX7?" screen display. Press [DEL] to get the "Are You Sure?" screen display.
- (d) Press [DEL] again, and WITHIN THREE SECONDS start pressing SW1 on the TF1. Press it three times at roughly 1-second intervals. If you start too late, the screen will revert to the Directory Display and you must go back to paragraph (c). If the screen has not changed, carry out the operation described in the next paragraph, again WITHIN THREE SECONDS.
- (e) Hold down SW2 on the TF1. You'll find that as the LED Display counts down from 32 to 1, the voices will appear on the video screen, one at a time. They are now loaded into the CX5M.

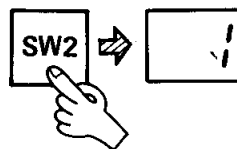

7-6. Dumping the Data of 32 Voices From the TX816 Into the CS5M

NOTE:

Function data will NOT be sent with this operation.

First carry out the operations described in paragraphs (a) thru (e) of operation 7-3.

- (a) Press the OUT SLOT SELECT key until the OUT SLOT LED displays the number of the TF1 module you wish to dump from.
- (b) Set the TF1 to the Select Program Number For Edit sub-mode, and hold down SW1 until program number 32 appears on the LED display. (This time our diagram assumes that the TF1 was set to program number 12).

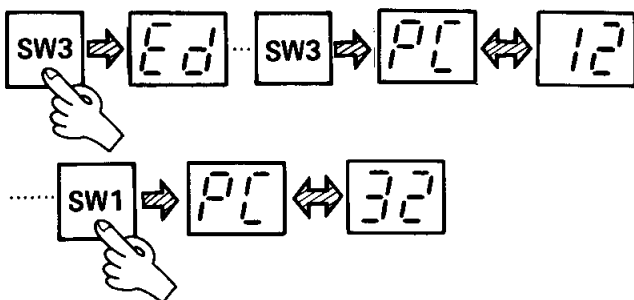

INDEX

NOTE:

All modes and sub-mode have their initial letters capitalized, e.g. Store Only Function.

Audio Check	7	Set Omni On/Off	4
basic system	3	Set Receive Basic Channel	4
battery check and replacement		Store Mode	6
(see Read Out Current Voltage of Battery)	8	Store Only Function	6
Clear And Initialize All Functions	7	Store Voice And Function	6
conventions	3	test tone (see Audio Check)	7
CX5M, checking TF1 voice parameters with	13	Tune Master Pitch	4
CX5M, dumping voice data into	14	Utility Mode	7
CX5M, editing with the DX7 Voicing Program	12	voice dumping	
CX5M, loading single voice data into TF1	13	(see Dump All Voices And Functions)	7
CX5M, loading 32 voices into TF1	13	voice storing	
CX5M plus FM Music Composer Program	12	(see Store Voice And Function)	6
destination (see select destination)	6		
Dump All Voices And Functions	7		
DX7, dumping voice data into	9		
DX7, loading single voice data into TF1	9		
DX7, loading 32 voices into TF1	9		
DX7 Voicing Program	12		
Edit Mode	5		
FM Music Composer Program	12		
function data, dumping			
(see Dump All Voices And Functions)	7		
function data, initializing			
(see Clear And Initialize All Functions)	7		
function data, storing (see Store Only Function)	6		
highest key limit (see Limit Highest Key)	5		
initializing functions			
(see Clear and Initialize All Functions)	7		
internal memory of DX7	9		
internal memory of TF1	7		
Limit Lowest Key	5		
Limit Highest Key	5		
Lowest Key Limit (see Limit Lowest Key)	5		
MIDI channel select			
(see Set Receive Basic Channel)	4		
Music Composer Program	12		
Omni (see also Set Omni On/Off)	7		
pitch (see Tune Master Pitch)	4		
Play Mode	4		
program selection			
(see Select Program Number For Edit)	5		
QX1, dumping data into	10		
QX1, loading data into TF1	10		
Read Out Current Voltage Of Battery	8		
saving data			
(see Dump All Voices and Functions)	7		
Select Destination	6		
Select Program Number For Edit	5		

SINCE 1887  **YAMAHA**
NIPPON GAKKI CO., LTD. HAMAMATSU, JAPAN