



# **ENSPIRE Controller Operation Manual**

# Introduction

---

Thank you for purchasing the Yamaha Disklavier!  
The ENSPIRE Controller allows you to control many of the basic functions of your Disklavier.  
Please read this manual before operating the Disklavier.



## NOTE

- Instructions on operating this unit refer mainly to use of the screens in landscape view. For instructions on portrait view, refer to “Screen Layout in Portrait View.” [page 51](#)
- The illustrations and screens as shown in this manual are for instructional purposes only, and may appear somewhat different from actual item depicted.
- Specifications are subject to change without notice.

## Trademarks & Copyrights:

- The contents of this manual and the copyrights thereof are under exclusive ownership by Yamaha Corporation.
- Yamaha, Disklavier™, disklavier ENSPIRE™, SILENT Piano™, and DisklavierRadio are trademarks of Yamaha Corporation.
- The company names and product names in this operation manual are the trademarks or registered trademarks of their respective companies.

# Table of Contents

---

Introduction.....	2	DisklavierRadio Screen.....	30
Control Screen .....	4	Logging in and/or Subscribing to the Service.....	31
Playing Function .....	6	DisklavierRadio Playback Screen .....	33
Metronome .....	7	Music Shop Screen .....	34
Voice List.....	8	Purchase History & Download Screen .....	35
Reverb Type List.....	10	Download Screen .....	36
Information Screen .....	11	Settings Screen.....	37
Balance Screen .....	13	Changing Wired / Wireless Network Connection Settings .....	38
Practice Function Menu .....	14	Setting the Disklavier for the Passcode .....	40
Changing the Playback Tempo.....	15	Login Passcode Screen .....	41
Playing Back Songs in a Different Key (Transpose) .....	16	Setting the Disklavier for Audio Reception/Transmission.....	42
Playing Back Only the Desired Piano Part .....	17	Setting the Disklavier for MIDI Data Reception/Transmission.....	44
Repeating a Specific Section of a Song (A-B Repeat) .....	18	Special Playback Screen .....	46
Songs Screen .....	19	Timer Play Screen.....	47
Search Screen .....	21	Timer Setting Screen .....	48
Editing Screen.....	22	System Screen .....	50
Recording Standby Screen.....	23	Screen Layout in Portrait View .....	51
Recording Screen.....	24	Troubleshooting.....	53
Saved Screen.....	25		
Video Sync Recording — Connection.....	26		
Video Sync Recording / Video Sync Playback .....	27		
L/R Recording Standby Screen.....	28		
Recording with Audio Standby Screen .....	29		

# Control Screen

Accessing the Disklavier from the ENSPIRE Controller app on your smart device calls up the Control screen.

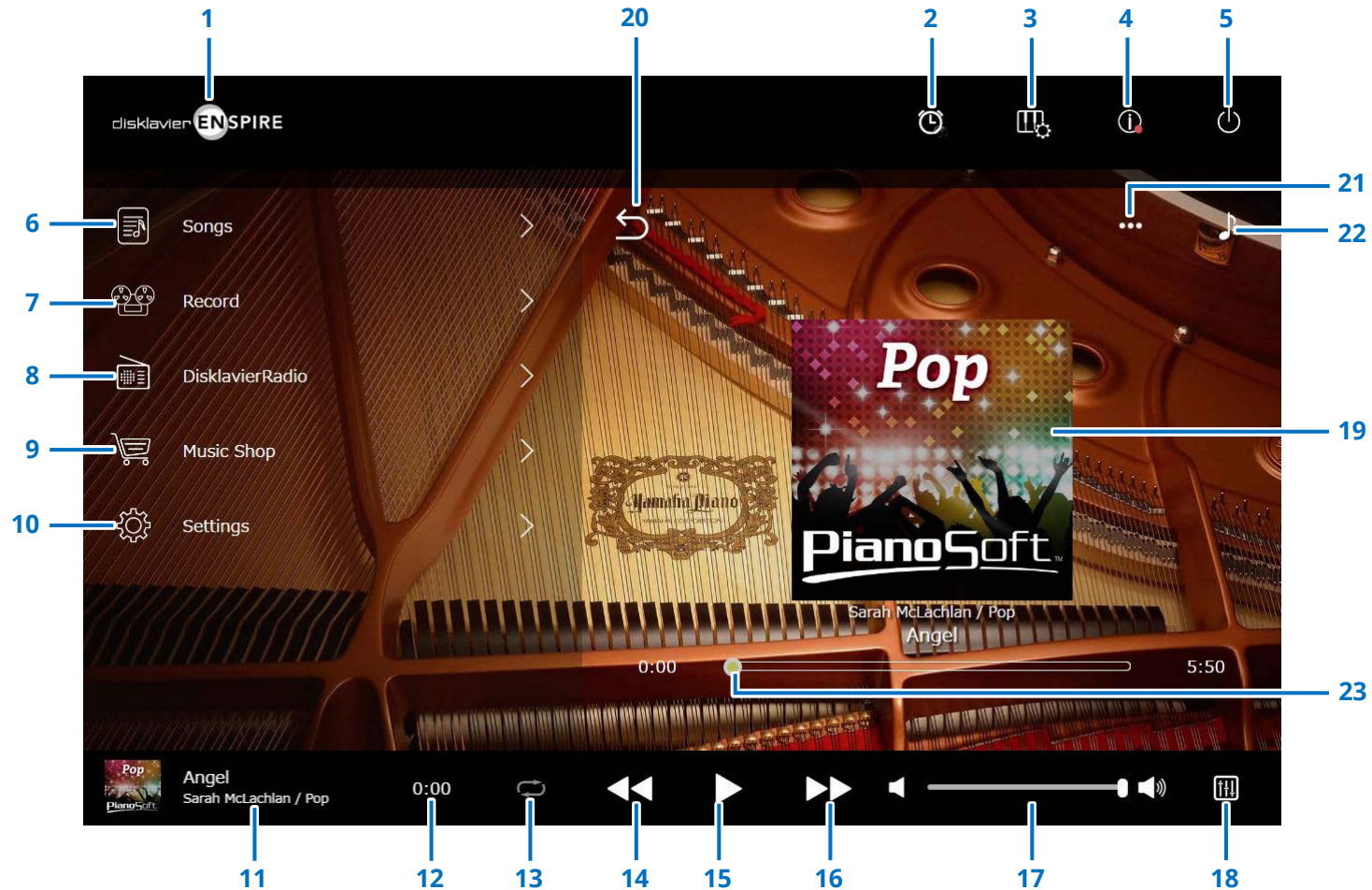

▶ Continued on next page

# Control Screen

---

## 1 Logo

Calls up the Playback screen.

## 2 Timer Play

Appears when the Timer is set.

Calls up the Timer Play screen. [page 47](#)

## 3 Playing Function [page 6](#)

## 4 Information [page 11](#)

## 5 Power (sleep)

Turn off the disklavier and set it to sleep.

## 6 Songs [page 19](#)

## 7 Record [page 23](#)

## 8 DisklavierRadio [page 30](#)

## 9 Music Shop [page 34](#)

## 10 Settings [page 37](#)

## 11 Loaded Song information

Shows information of the loaded Song:

- Cover art (or default image)
- Song title
- Artist
- Album title







Tapping this area calls up the Playback screen.

## 12 Playback time counter

Indicates the playback time.

## 13 Repeat

Opens the Repeat setting menu.

-  : Repeat off
-  : Repeats the selected Song
-  : Repeats all Songs in the album
-  : Shuffles all Songs in the album
-  : Repeats all albums in the Song category
-  : Shuffles all albums in the Song category

### NOTE

“Song category” refers to a group of Songs (Built-in Songs, Playlists, and so on), that appears on the Song screen. [page 19](#)

## 14 Skip back/Rewind

Skips to the previous Song when tapped briefly.  
Rewinds through the current Song when tapped and held for a longer period.

## 15 Play/Pause

Starts or pauses playback.

## 16 Skip/Fast forward

Skips to the next Song when tapped briefly. Fast-forwards through the current Song when tapped and held for a longer period.

## 17 Volume

Adjusts the volume of both the piano and speakers (when connected). Use the slider to adjust the volume.

## 18 Balance

Calls up the Balance screen. [page 13](#)

## 19 Playback Screen

Various information is shown in the right area. In the Control screen, the Playback screen appears.

The Playback screen shows:

- Cover art (or default image)
- Song title
- Artist
- Album title

## 20 Return

Returns to the Song screen.

## 21 Edit [page 22](#)

## 22 Practice Function [page 14](#)

## 23 Song position

Indicates the playback position. Use the slider to control playback.

# Playing Function

Tapping on the Playing Function button calls up the Playing Function.

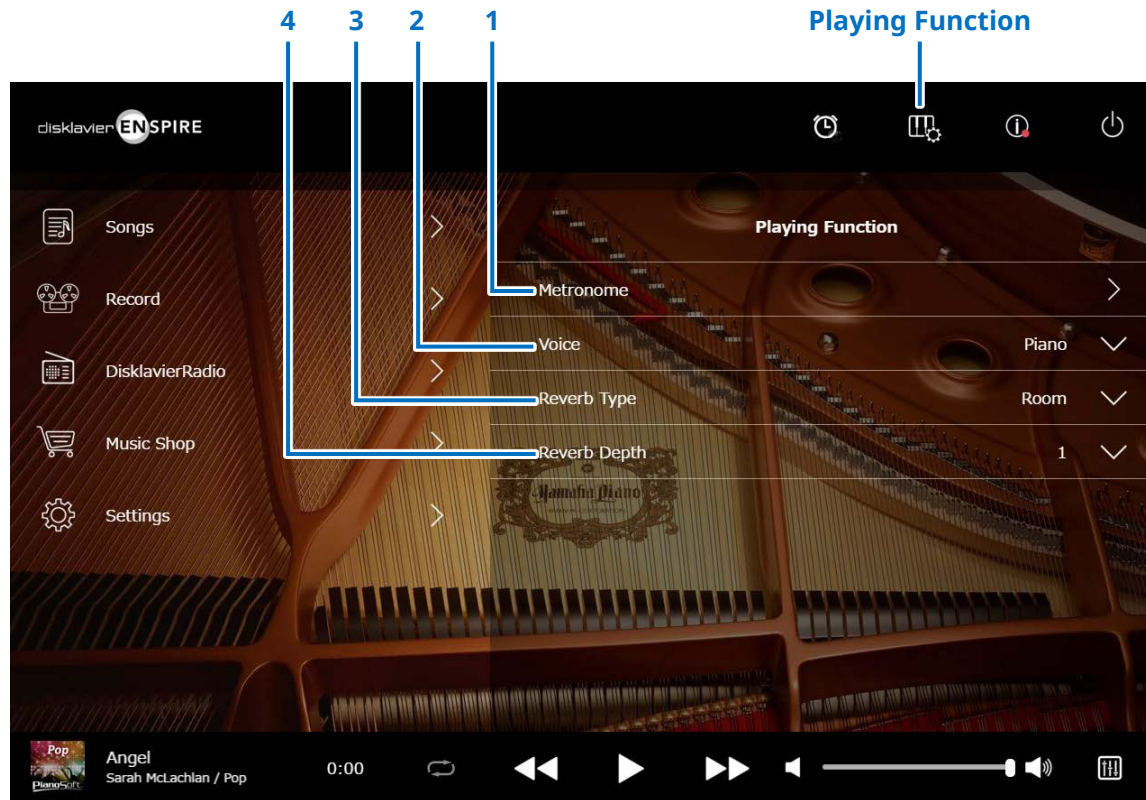

## 1 Metronome

Opens the Metronome pop-up window. [page 7](#)

- **Grand piano with SILENT Piano™ function:** The following functions are often used when selecting the Quiet or Headphone mode in the Balance screen.

[page 13](#)

- **Upright piano with SILENT Piano™ function:** The following functions are often used when you slide the center pedal to the left.

## 2 Voice

Selects the Voice.

For details on Voices, see the “Voice List.” [page 8](#)

### NOTE

If the piano does not have the SILENT Piano™ function, or if “Acoustic / Quiet” is set to “Acoustic” in the Balance Screen on the piano with SILENT Piano™ function, both the acoustic piano sound and the sound of the sound source will sound.

## 3 Reverb Type

Selects a Reverb Type.

For details on the Reverb Types, see “Reverb Type List.”

[page 10](#)

## 4 Reverb Depth

Adjusts the Reverb Depth.

Setting range is from 0 to 20.



# Metronome

In this pop-up window you can change the playback tempo and other settings of the Metronome.

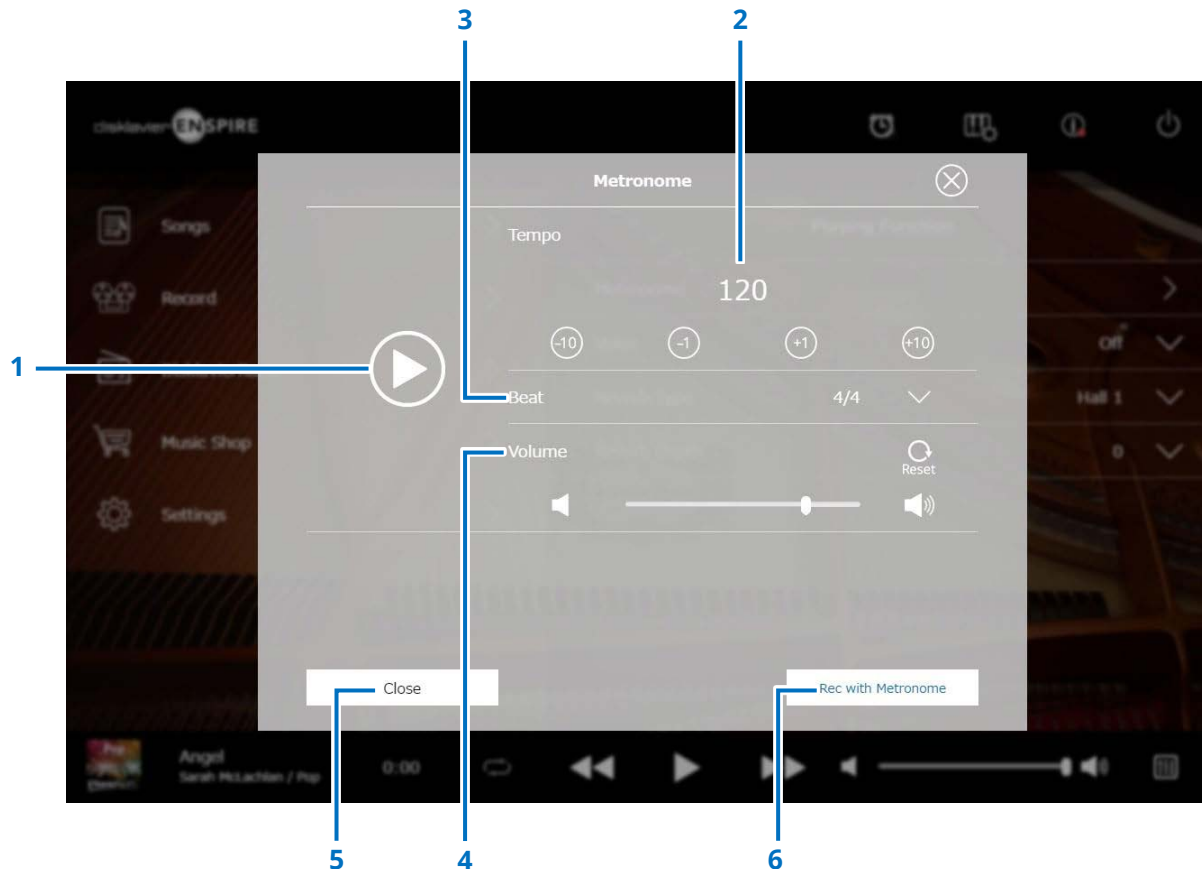

## 1 Play/Stop

Starts or stops Metronome playback.

## 2 Tempo

Adjusts the Metronome tempo over a range of 30 bpm to 400 bpm.

## 3 Beat

Changes the beat (time signature) to one of the following settings:

1/4, 2/4, 3/4, 4/4, 5/4, 6/4, 7/4, 8/4, 9/4.

## 4 Metronome volume

Adjusts the Metronome volume. Use the slider to adjust the volume.

## 5 Close

Closes the Metronome pop-up window.

## 6 Rec with Metronome

Enables recording while hearing the Metronome. The Metronome sound will not be recorded.

# Voice List

Voice	Explanation
OFF/Piano *1	This sound was sampled from the Yamaha CFX concert grand piano. It uses different samples depending on the strength of your playing and produces smoother tonal changes. Even the tonal changes produced by the damper pedal and the subtle sounds of releasing the keys are reproduced. The sympathetic vibration (String Resonance) that occurs among the strings of an acoustic piano has also been simulated. Suitable not only for classical compositions but also for piano pieces of any style.
Electric Piano 1	An electronic piano sound produced by an FM synthesizer. The tone will change as you vary your playing touch. Ideal for popular music. Pressing the soft pedal/shift pedal switches between on and off of the chorus effect.
Electric Piano 2	The sound of an electric piano using hammer-struck metallic "tines." Soft tone when played lightly, and an aggressive tone when played hard. Pressing the soft pedal/shift pedal switches between on and off of the chorus effect.
Electric Piano 3	A different type of electric piano sound. Widely used in rock and popular music. Pressing the soft pedal/shift pedal switches between on and off of the chorus effect.
Harpsichord 1	The sound of an instrument frequently used in baroque music. Variations in playing touch will not affect the volume, and a characteristic sound will be heard when you release the key.
Harpsichord 2	A harpsichord with an added upper octave. Produces a more brilliant sound.
Vibraphone	Vibraphone played with relatively soft mallets. The tone becomes more metallic the harder you play. Pressing the soft pedal/shift pedal switches between on and off of the vibrato.
Celesta	The sound of a celesta (a percussion instrument in which hammers strike tuned metallic bars to produce sound). This instrument is well-known for its appearance in "Dance of the Sugarplum Fairies" from Tchaikovsky's "Nutcracker Suite."
Pipe Organ 1	This voice features the combination of pipes (8'+4'+2') of a principal (brass instrument) organ. It is suitable for Baroque church music.
Pipe Organ 2	This voice features a full coupler of a pipe organ, famous for the sound used in "Tocatta and Fugue in D minor" by Bach.

\*1 For pianos with the SILENT Piano™ function, when "Acoustic / Quiet" is set to Acoustic in the Balance Screen, the Voice is set to "OFF." When selecting "Quiet" or "Headphone," the Voice is set to "Piano."  
If the piano does not have a SILENT Piano™ function, this will be set to "OFF."



# Voice List

---

Voice	Explanation
Pipe Organ 3	A pipe organ sound that combines flute-type (woodwind type) stops of different pitches (8'+4'). This is a gentle sound that is ideal for accompanying hymns.
Pipe Organ 4	A pipe organ sound that combines flute-type (woodwind type) stops of different pitches (8'+4'+1-1/3'). This is brighter than Pipe Organ 3, and is suitable for solos.
Jazz Organ	The sound of a "tonewheel" type electric organ. Often heard in jazz and rock idioms. Pressing the soft pedal/shift pedal switches the rotary speaker speed (fast and slow).
Strings	Stereo-sampled, large-scale strings ensemble with realistic reverb.
Choir	A big, spacious choir voice. Perfect for creating rich harmonies in slow pieces.
Synth Pad	A warm, mellow, and spacious synth sound. Ideal for sustained parts in the background of an ensemble.

## Reverb Type List

---

Reverb Type	Explanation
Room	Reverberation similar to that heard in a normal room.
Hall 1	Reverberation similar to that heard in a small concert hall.
Hall 2	Reverberation similar to that heard in a large concert hall.
Stage	Reverberation similar to that heard on a stage.

# Information Screen

Tapping on the Information button calls up the Information screen.

(If you have not logged in)

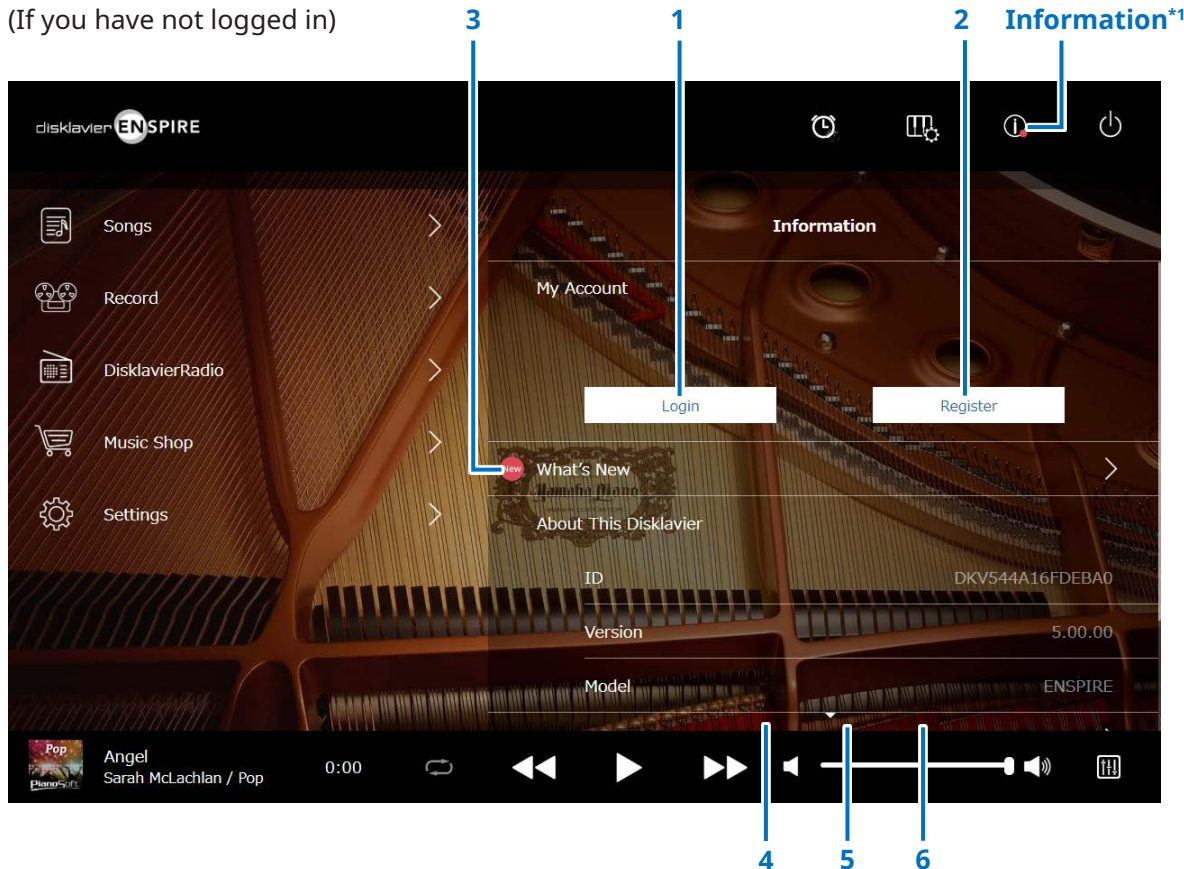

## 1 Login\*<sup>2</sup>

Opens the Login pop-up window. You can log in to Yamaha MusicSoft. You need to enter your e-mail address and password.

## 2 Register\*<sup>2</sup>

Opens the account registration page for Yamaha MusicSoft in a separate browser tab.

## 3 What's New\*<sup>2</sup>

Calls up the What's New screen, which shows the five latest news items about the Disklavier.

## 4 Firmware Update\*<sup>2</sup>

Opens the Firmware Update pop-up window.

Scrolling down the screen calls up the following items:

## 5 Operation Manual

Opens the Operation Manual in a separate browser tab.

## 6 Software License

Opens the Software License in a separate browser tab.

\*1 A red dot is shown on the Information button when the Information screen has been updated.

\*2 Internet connection required.

# Information Screen

(If you have logged in)

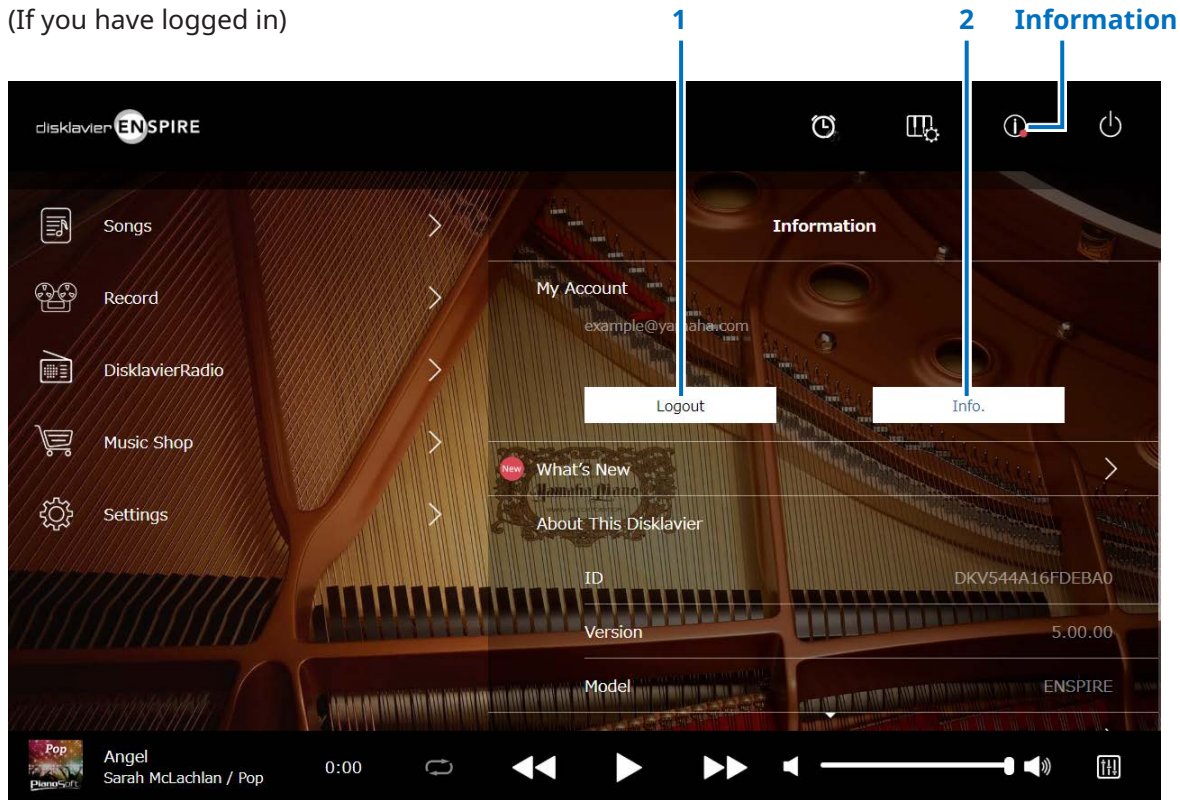

## 1 Logout\*<sup>1</sup>

Opens the Logout pop-up window.

## 2 Info.\*<sup>1</sup>

Opens the My Account pop-up window, from which you can confirm your subscription status and account information.

\*1 Internet connection required.

# Balance Screen

Tapping on the Balance button calls up the Balance screen.

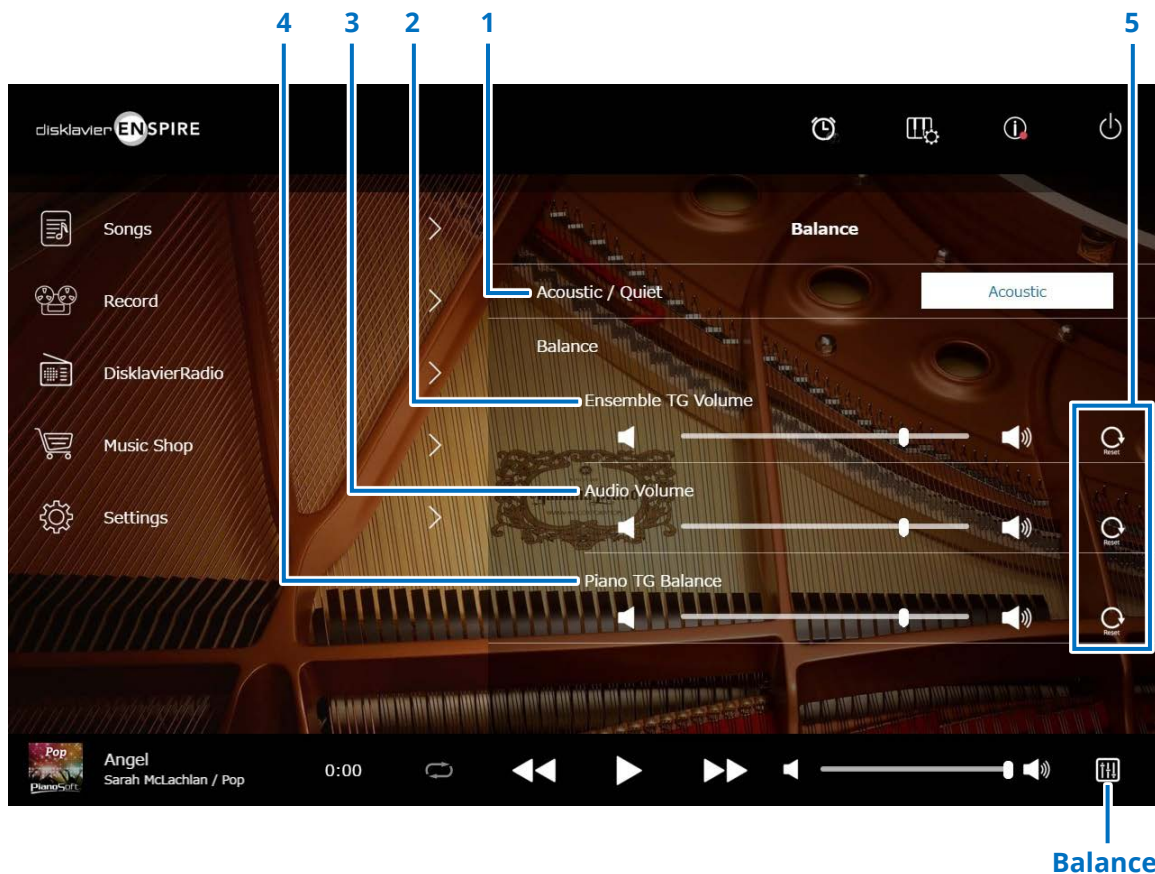



## 1 Acoustic/Quiet (Piano with SILENT Piano™ function only) \*1



Cycles through the following output options.

- **Acoustic:** Outputs as an acoustic piano
- **Quiet:** Outputs piano sound through the monitor speaker(s) connected to the OUTPUT jacks
- **Headphone:** Outputs sound through the stereo headphones connected to the [HEADPHONE] jack



## 2 Ensemble TG Volume

Adjusts the volume of the ensemble parts. Use the  /  buttons or slider to adjust the volume.

## 3 Audio Volume

Adjusts the volume of the audio. Use the  /  buttons or slider to adjust the volume.

## 4 Piano TG Balance

Adjusts the volume of the piano parts. Use the  /  buttons or slider to adjust the volume.

## 5 Reset

Resets the volume to its default value.

\*1 "Acoustic/Quiet" is locked to "Headphone" when you connect headphones.

For upright pianos, "Acoustic/Quiet" cannot be set on this screen. The setting is locked to "Quiet" when you slide the center pedal to the left.



# Practice Function Menu

Tapping on the Practice Function button opens the Practice Function menu.

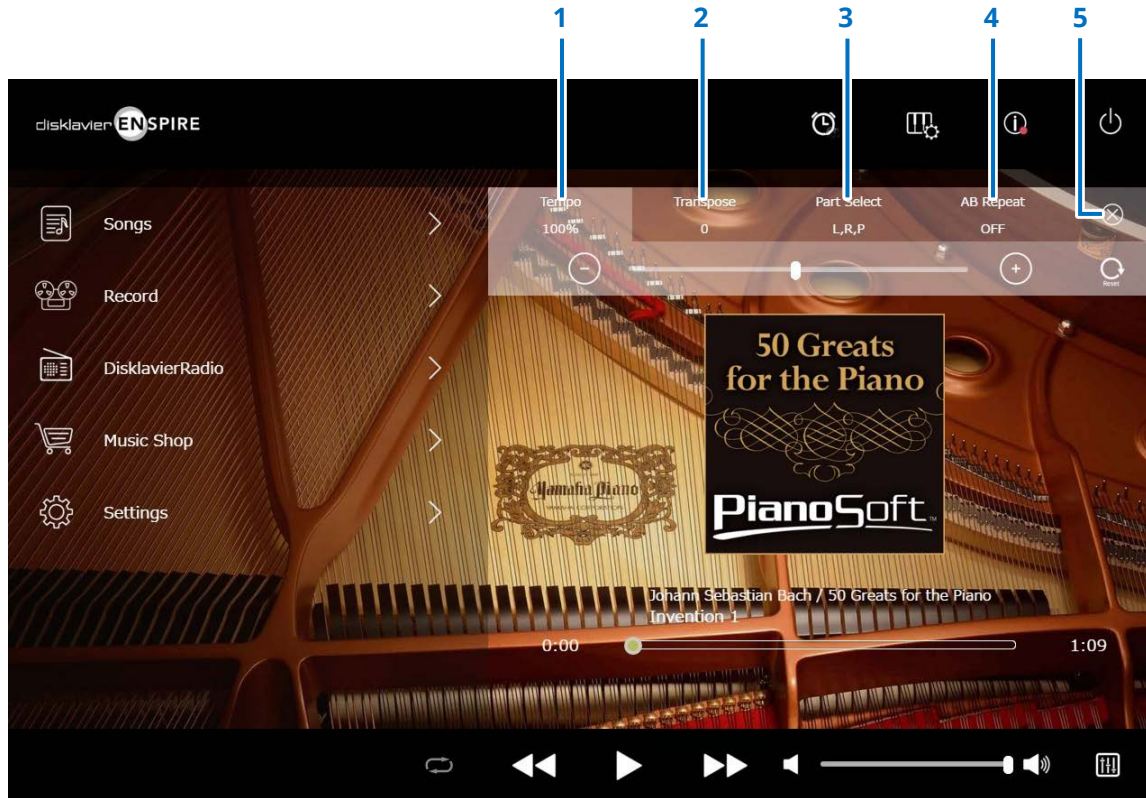

1 Tempo [page 15](#)

2 Transpose [page 16](#)

3 Part Select [page 17](#)

4 A-B Repeat [page 18](#)

5 Close

Closes the Practice Function menu.

## NOTE

These settings remain in effect until another Song is selected, or the power is turned off.



# Changing the Playback Tempo

You can speed up or slow down the Playback Tempo.

Slowing down the Playback Tempo can be useful when practicing a difficult piano part.

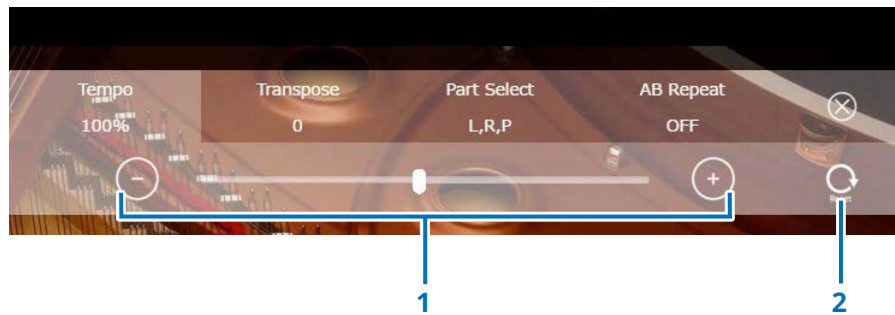

## 1 Tempo controls

Adjusts the Playback Tempo. The Playback Tempo can be adjusted over a range of 50% to 150%. Use the -/+ buttons or slider to adjust the Playback Tempo.

## 2 Reset

Resets the Playback Tempo to 100%.

### NOTE

You cannot change the Playback Tempo of the Pianosoftware Songs and WAV format Songs. (The Song of which Song type is "Audio" and "wav." [page 20](#) )

# Playing Back Songs in a Different Key (Transpose)

Playback can be transposed up or down by up to two octaves. This is useful, for example, when you want to sing along (karaoke) in a different key from the original recording.

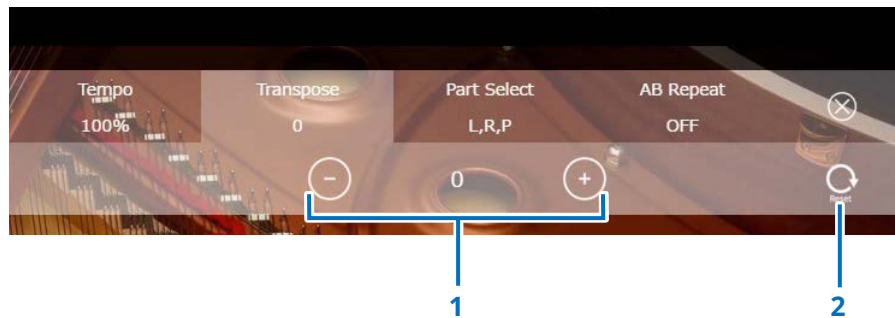

## 1 Transpose controls

Playback can be transposed in half-step increments up or down two octaves (-24 key to +24 key). Use the -/+ buttons or slider to adjust the Transpose function.

## 2 Reset

Restores the original key (0).

# Playing Back Only the Desired Piano Part

You can select the desired piano part. For example, this could be useful for practicing only one part (left- or right-hand) while the Disklavier plays the other.

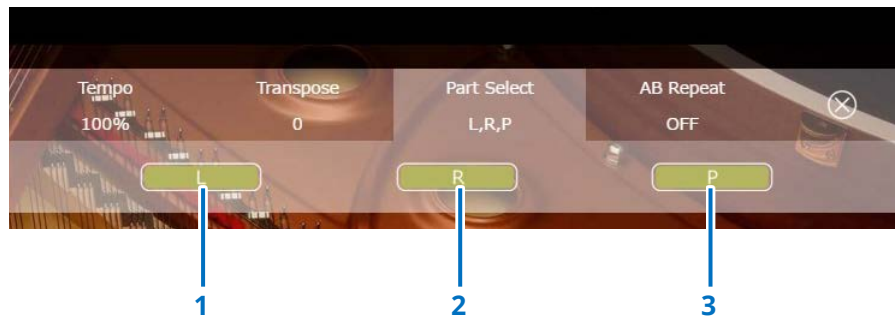

**1 L**

Plays or cancels the left part.

**2 R**

Plays or cancels the right part.

**3 P**

Plays or cancels the pedal part.

## Memo

The above screen indicates that all parts are to be played back.

# Repeating a Specific Section of a Song (A-B Repeat)

When using A-B Repeat, playback is repeated between two specified points (point A and point B) in a Song. This is useful when practicing or memorizing a difficult section of a Song.

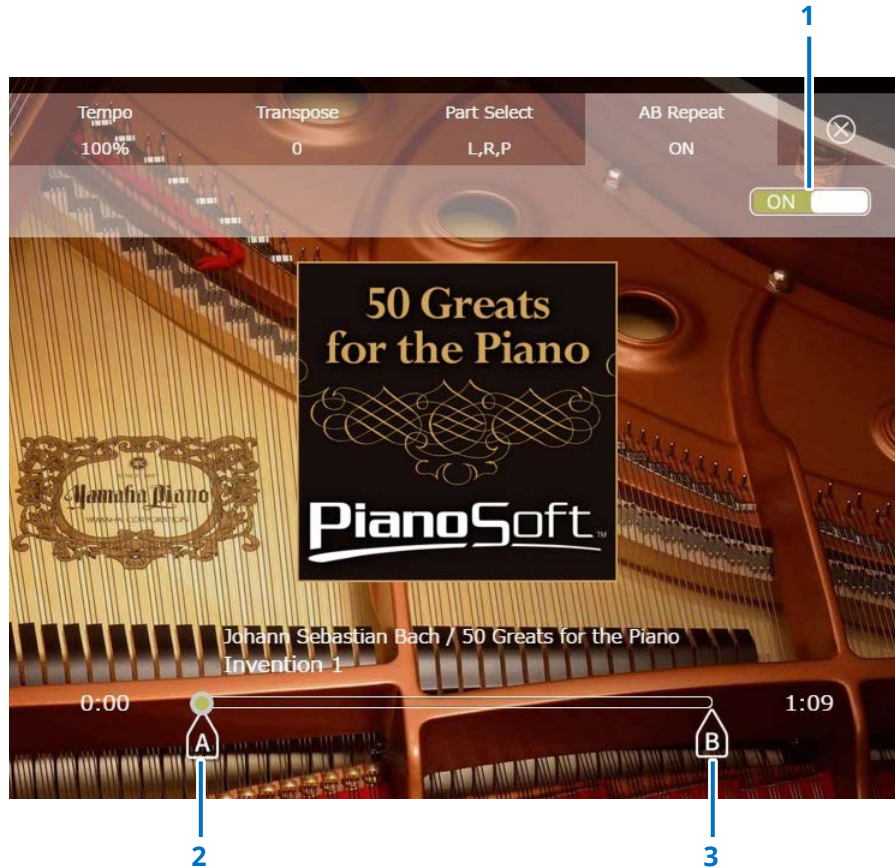

## 1 A-B Repeat

Turns A-B Repeat on or off. This switch is automatically turned on when opening the A-B Repeat setting menu.

## 2 Point A

Indicates point A. Slide this mark to set point A.

## 3 Point B

Indicates point B. Slide this mark to set point B.

Playback starts from point A, continues up to point B, and returns to point A. Playback cycles between point A and point B.

# Songs Screen

Tapping on the Songs button calls up the Songs screen.

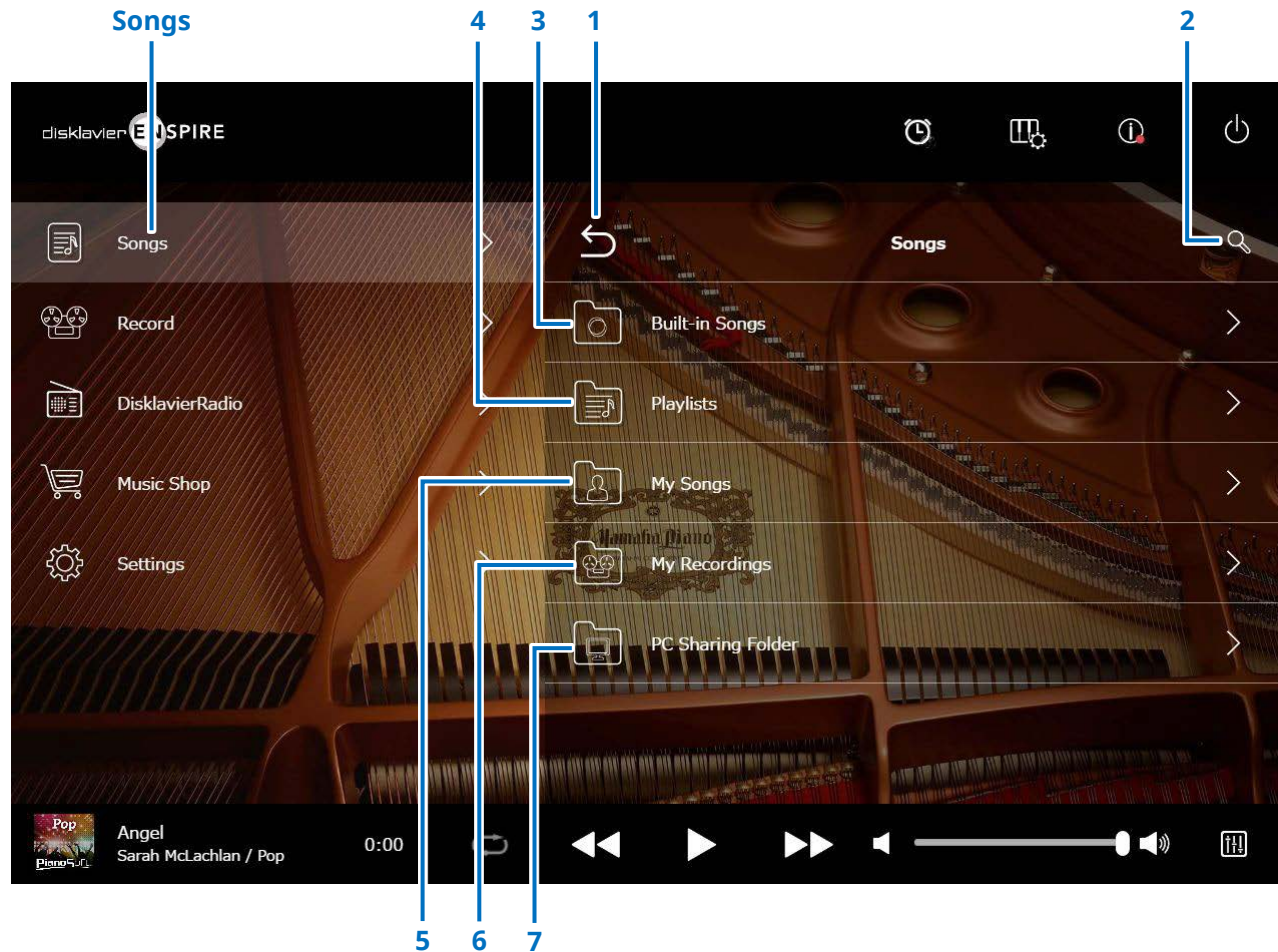

## NOTE

My Songs, My Recordings and PC Sharing Folder appear only when a USB flash drive is connected.

▶ Continued on next page

# Songs Screen

---

## 1 Return

Returns to the Playback screen.

In Portrait View, returns to the Menu screen.

## 2 Search

Lets you search for the desired Song. [page 21](#)

## 3 Built-in Songs

Folder containing Built-in Songs.

## 4 Playlists

Folder containing Songs you have registered as favorites.

Playlists can be added on the edit screen. [page 22](#)

## 5 My Songs

Folder containing Songs in a USB Flash drive.

### > Downloaded Songs

Folder containing Songs you have purchased at Yamaha MusicSoft.

## 6 My Recordings

Folder containing recorded Songs that have been saved.

### > Recorded Songs

All recorded Songs are saved in this folder.

### > Kept Songs

You can move recorded Songs to this folder from the following screens:

- Saved screen [page 25](#)
- Editing screen of My Recordings [page 22](#)

The Kept Songs folder is useful for storing favorite or often-used Songs. You can delete unnecessary Songs in Recorded Songs folder after moving the desired Songs to the Kept Songs folder.

## 7 PC Sharing Folder

Folder containing Songs shared with a personal computer.

To share data with Disklavier and a PC (computer), connect the PC to the same router (to which the Disklavier is connected) and then search for the Disklavier ID in the network list of the PC.







### Reload

Reloads the contents in the folder.

## Song type

Indicates the Song type.

-  **Audio:** Songs with audio accompaniment
-  **Plus:** Songs with MIDI accompaniment
-  **Solo:** Piano solo songs
-  **WAV:** WAV format Songs
- **(No mark):** Songs you have registered

The Song Type icon is not indicated in Portrait View.

### NOTE

My Songs, My Recordings and PC Sharing Folder appear only when a USB flash drive is connected.



# Search Screen

Tapping on the Search button  calls up the Search screen.  
You can search for your desired Songs.

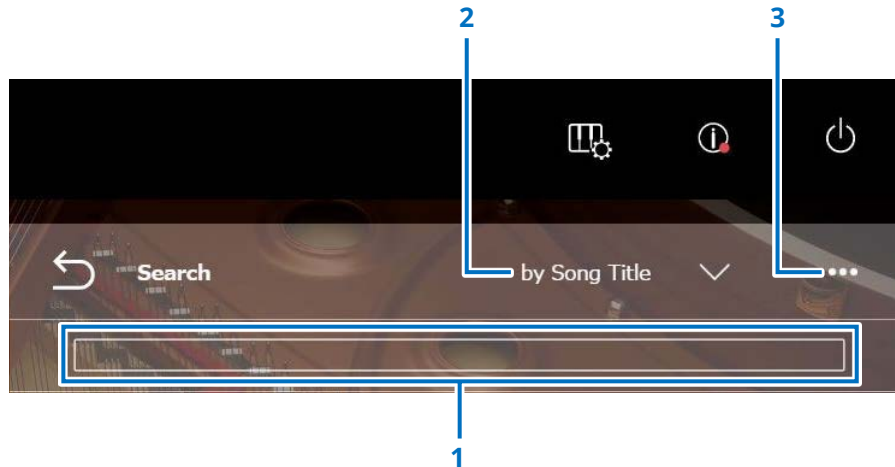

## 1 Input area

You can input any letter and then go to search.

## 2 Select Search Category

You can search for desired Songs via the following categories.

- Song title
- Artist
- Genre
- Song type

### NOTE

"Search Category" may vary according to the Song category.

## 3 Edit

Calls up the Editing Screen.

### NOTE







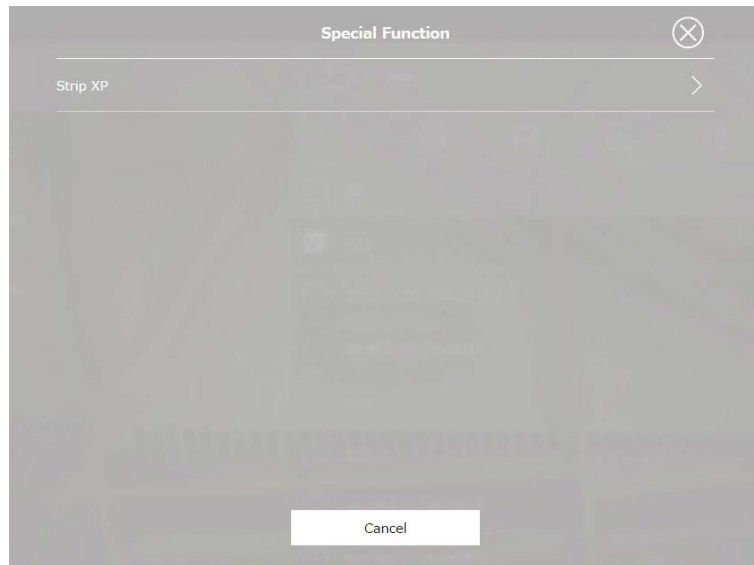

The edit screen is displayed only when a USB flash drive is connected.

# Editing Screen

The edit screen is displayed only when a USB flash drive is connected.

Tapping on the Edit button  opens the Editing screen. The editing menu may differ depending on the Song. Selects the Song/Album you want to edit.



-  **Copy**  
Copies the selected Song.
-  **Delete**  
Deletes the selected Song.
-  **Rename**  
Renames the selected Song.
-  **Sort**  
Rearranges the order of the Songs in a folder.
-  **Add to playlist**  
Adds the selected Song to the playlist.
-  **Create**  
Creates a new folder.
-  **Move to Kept Songs folder**  
Moves the selected Song to the Kept Songs folder. [page 20](#)
-  **Re-record** \*1  
Calls up the L/R Recording Standby screen. [page 28](#)
-  **Special Function**  
Opens the Special Function pop-up window.
- **Strip XP**  
Deletes XP messages from the song data.

\*1 "Re-record" is valid only when "OMNI OUT" is set to anything other than "Sync" on the audio input / output screen.  
Select single or multiple for each feature.

# Recording Standby Screen

Tapping on the Record button calls up the Recording Standby screen.

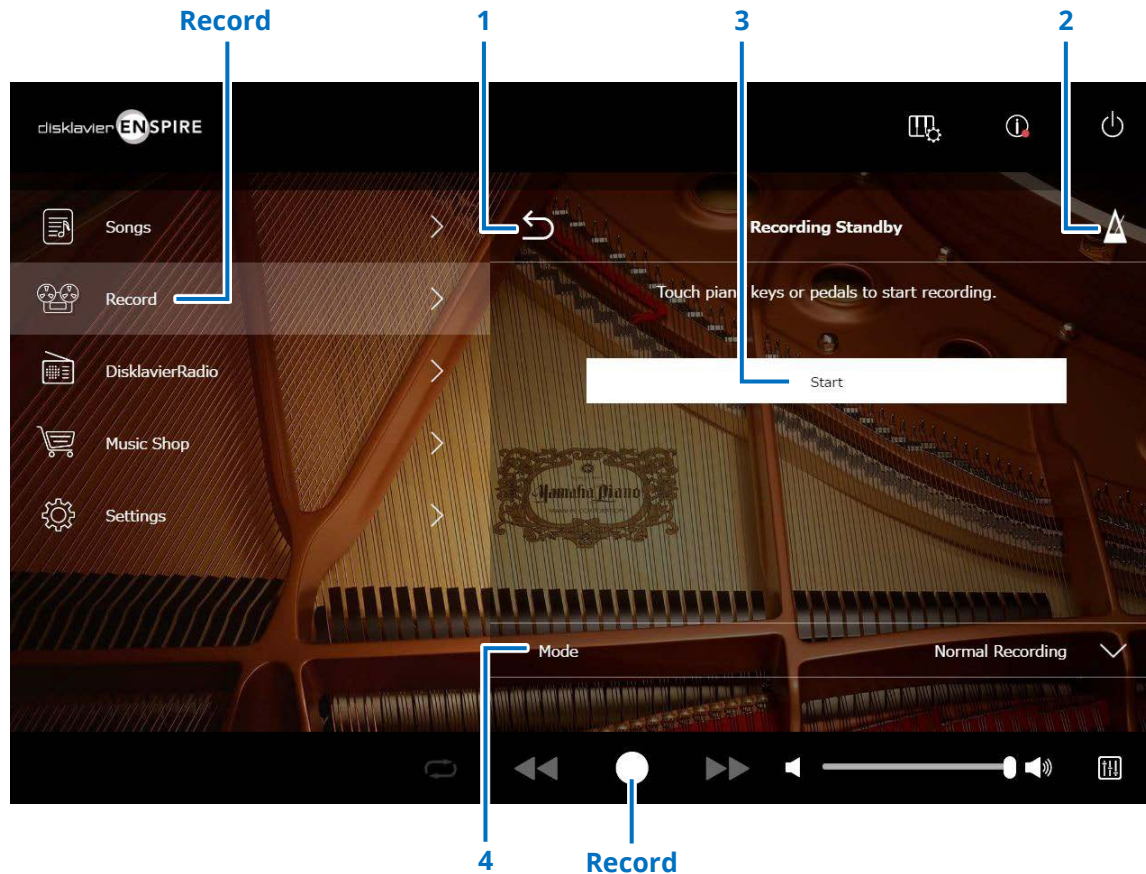

## 1 Return

Returns to the Playback screen.  
In Portrait View, returns to the Menu screen.

## 2 Metronome [page 7](#)

## 3 Start

Recording will start as soon as you touch the piano keys or pedals, or tap on the Start button. [page 24](#)

### NOTE

Tapping on the Record button in the lower area also starts recording.

## 4 Mode

You can record your Song via the following five methods.

- **Normal Recording (this page)**

- **Audio Recording (this page)**

Records the performance as an Audio Song (44.1 KHz/16 bit, stereo WAV).

### NOTE

The keyboard does not move during Audio Song playback.

- **Recording with Audio [page 29](#)**

- **Video Sync Recording [page 27](#)**

- **L/R Recording [page 28](#)**

Selects the recording mode from the list.

 Continued on next page

# Recording Screen

Once you start recording, the Recording screen appears.

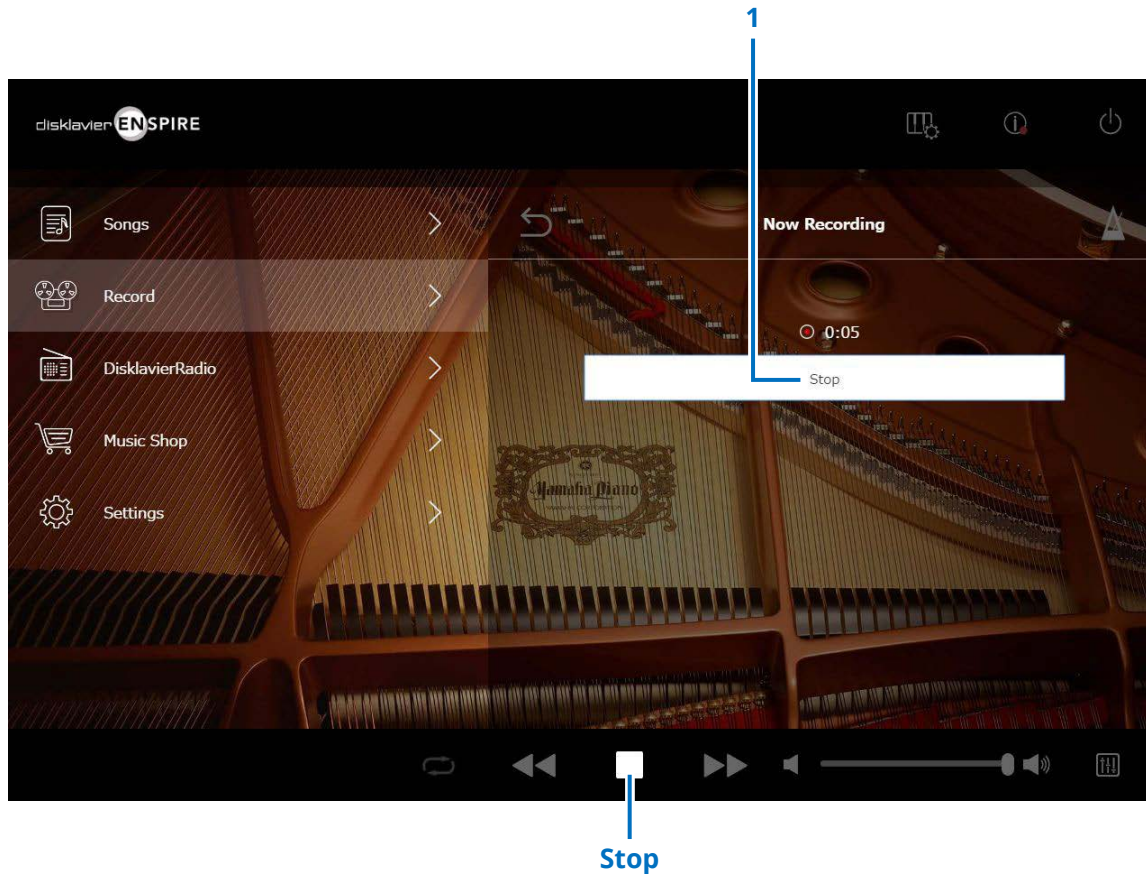

## 1 Stop

Stops recording.

### NOTE

Tapping on the Stop button in the lower area also stops recording.

Tap on the Stop button when you've finished playing. The recorded Song is saved and loaded. [page 25](#)

# Saved Screen

The recorded Song is automatically saved and loaded after stopping recording.

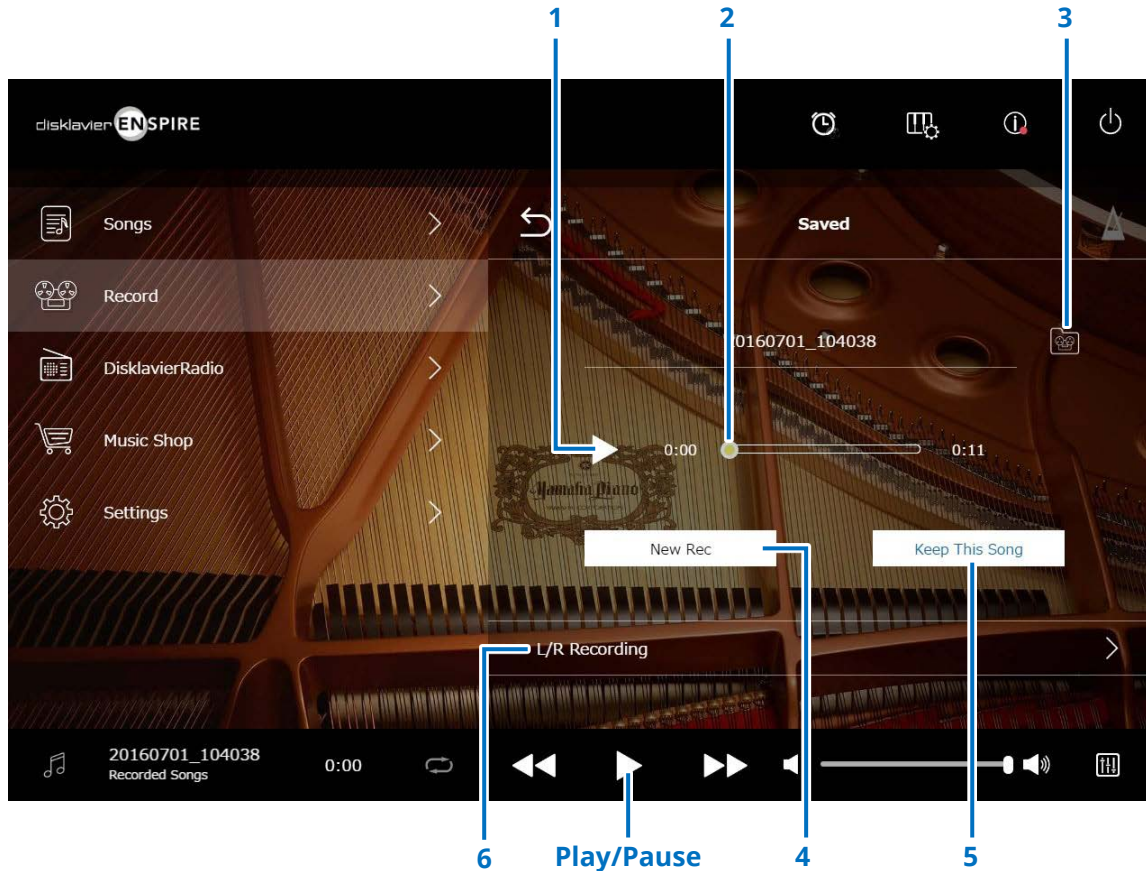

## 1 Play/Pause

Starts or pauses playback of the recorded Song.

### NOTE

Tapping on the Play/Pause button in the lower area also starts or pauses playback of the recorded Song.

## 2 Song position

Indicates the playback position. Use the slider to control the playback.

## 3 Recorded Songs

Calls up the Recorded Songs folder screen. [page 20](#)

## 4 New Rec

Returns to the Recording Standby screen. [page 23](#)

This does not appear after L/R recording.

## 5 Keep This Song

Opens the Keep pop-up window, letting you rename the Song and move it to the Kept Songs folder. [page 20](#)

## 6 L/R Recording

Calls up the L/R Recording Standby screen. [page 28](#)

It does not appear after Audio recording or Video sync recording.



# Video Sync Recording — Connection

Connect a video camera recorder and a DVD recorder to the control unit for Video Synchronized Recording.

- Grand piano
- DKC-900

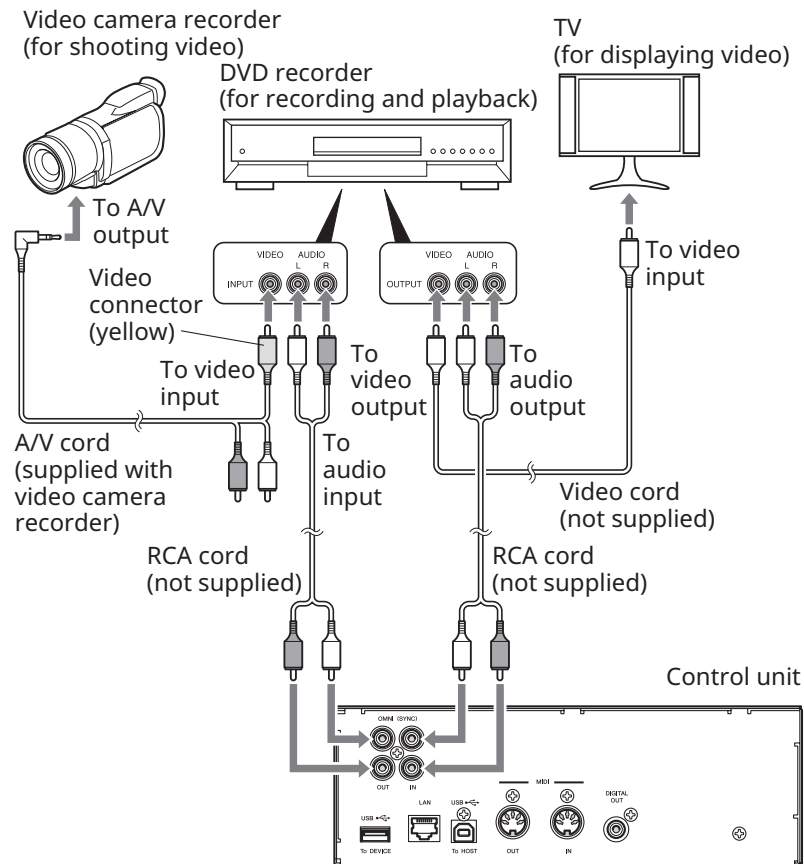

- Upright piano

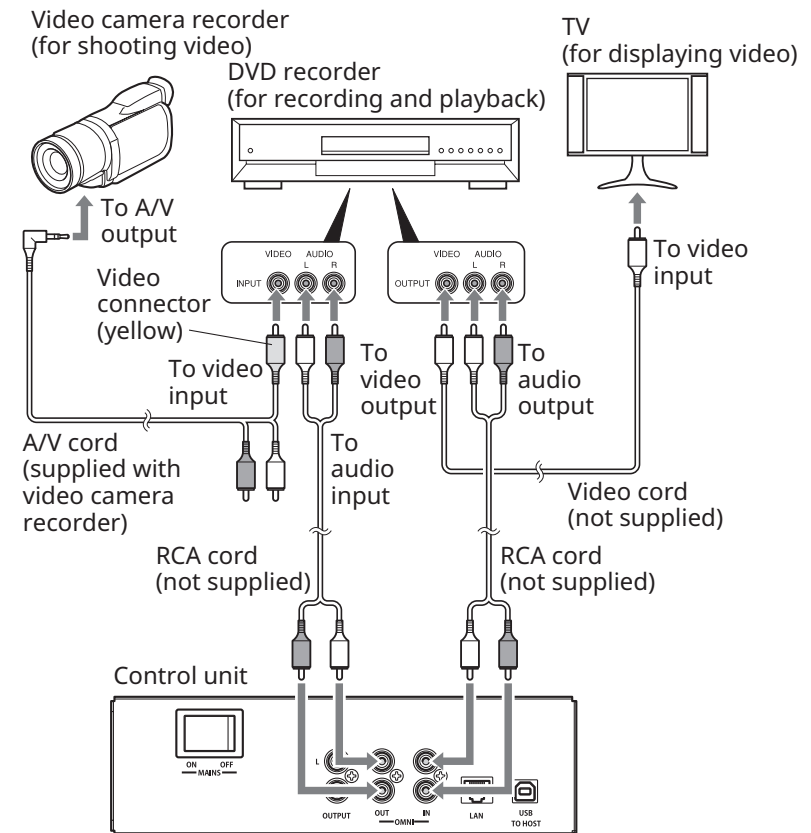



## Video Sync Recording / Video Sync Playback

You can record both a Song and video at the same time by connecting to a video camera or DVD recorder, when “OMNI OUT” is set to “Sync.” [page 42](#)  
The recorded Song is perfectly synchronized with the video during playback (Video Sync Playback), giving you a complete visual/music experience and the capability of creating your own music videos.

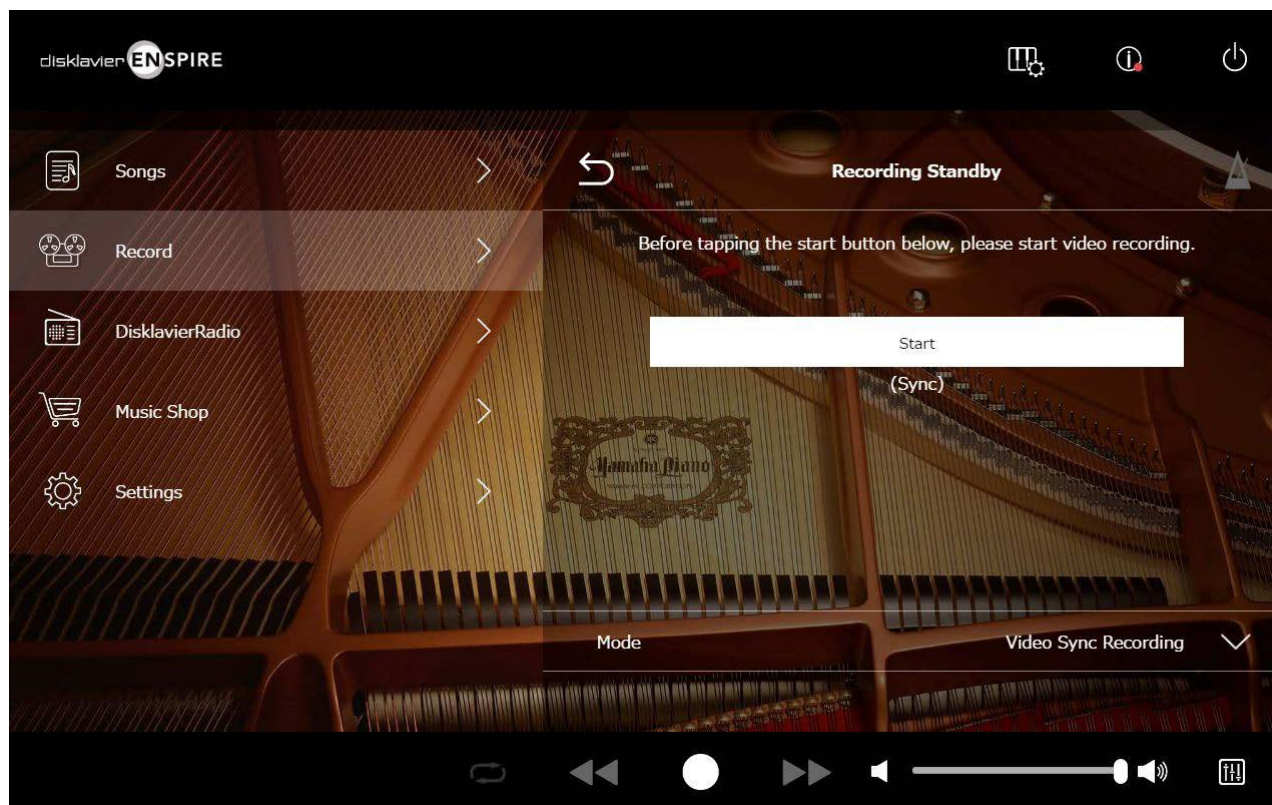

When you start playback on the DVD recorder, the Disklavier finds the appropriate Song and starts Video Sync Playback automatically.

### NOTE

- Turn the TV volume off.
- If some problem occurs with Video Sync Playback, refer to the “Troubleshooting” section. [page 55](#)

# L/R Recording Standby Screen

The left- and right-hand parts can be recorded separately. Either part can be recorded first, and the pedals can be recorded with the first part.

While you record the second part, the first part will play back for monitoring.

Tapping on the L/R Recording button calls up the L/R Recording Standby screen. You can also call up the L/R Recording Standby screen by tapping the Re-record button in the Editing Screen. [page 22](#)

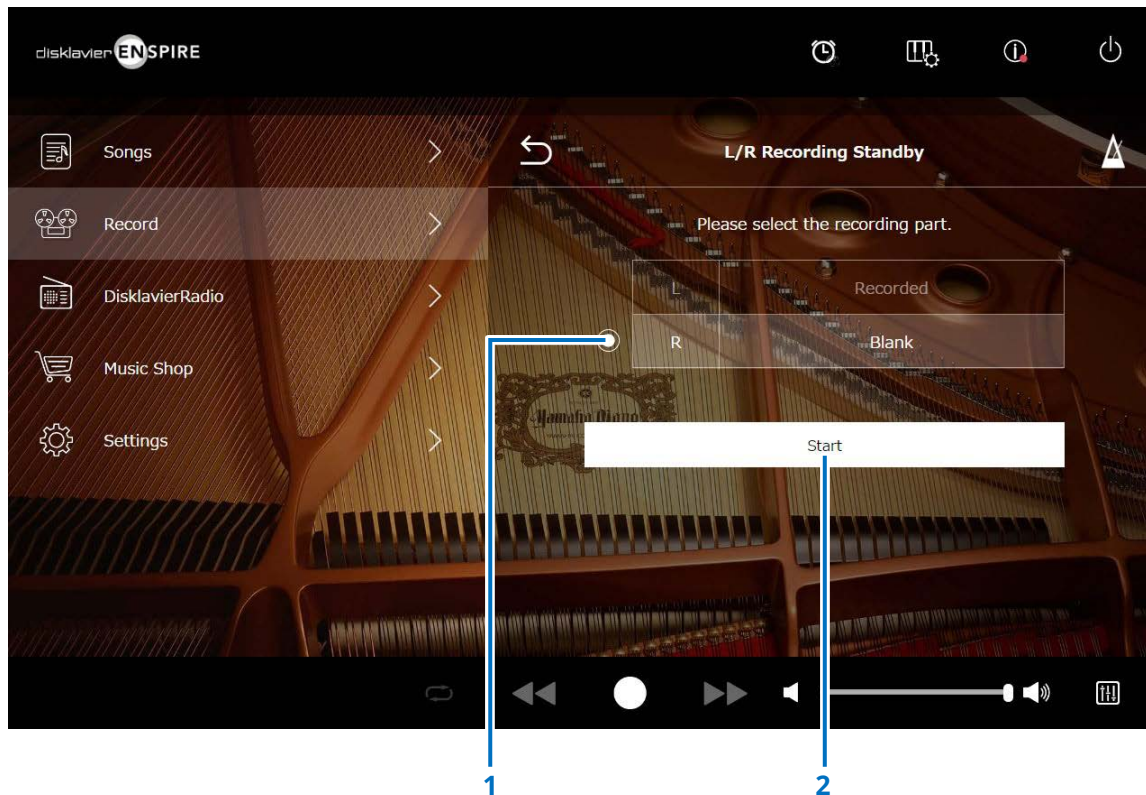

## 1 Radio button

Selects the “Blank” part, allowing you to record a separate part independently.

## 2 Start

Starts the recording and calls up the L/R Recording screen.

# Recording with Audio Standby Screen

You can record your piano performance as MIDI data and the audio input from the OMNI IN jack as audio (WAVE file) data simultaneously.

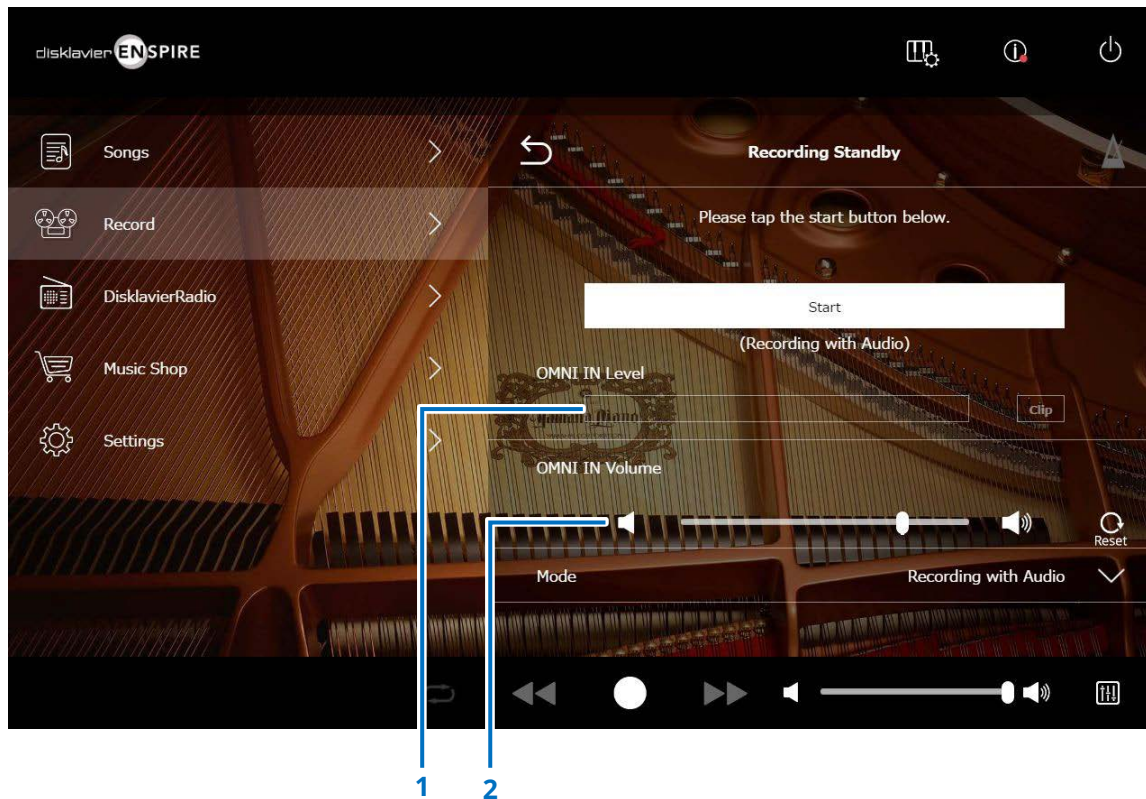

## 1 OMNI IN Level

Indicate the volume level of OMNI IN. The [Clip] lights up when the volume goes beyond recordable level.

In that case, adjust the volume level.

## 2 OMNI IN Volume

Adjusts the volume of the OMNI IN.



# DisklavierRadio Screen

Tapping on the DisklavierRadio button connects to the server.

When the Disklavier is successfully connected to the server, the channel list of DisklavierRadio appears.

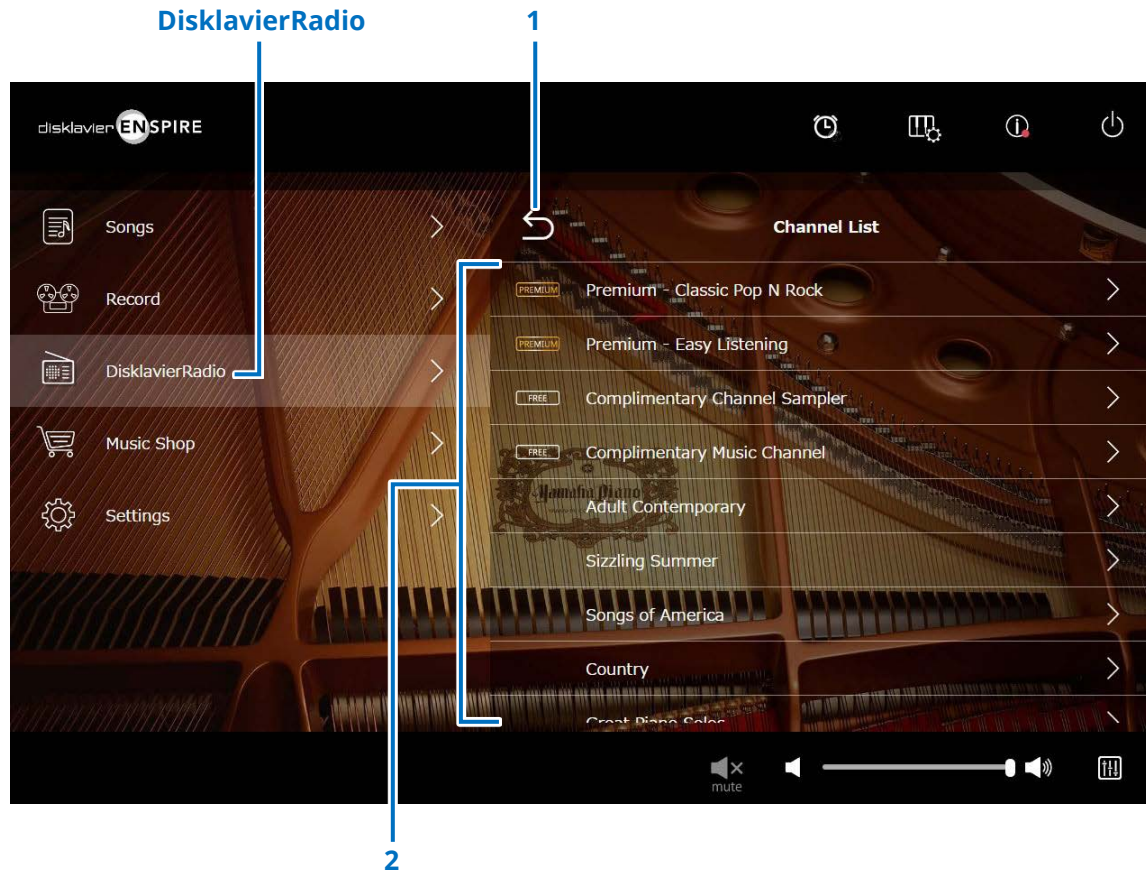

## 1 Return

Disconnects from the server and returns to the Playback screen.

## 2 Channel list

Shows the free and pay channels.

### Tapping on the free channel:

The DisklavierRadio Playback screen appears. [page 33](#)

### Tapping on the pay channel:

- If you have logged in and subscribed to the service, the DisklavierRadio Playback screen appears. [page 33](#)
- If you have not logged in or not subscribed to the service, the Information pop-up window of the pay channel appears. [page 31](#)

## NOTE

The DisklavierRadio channels are subject to change without prior notice.

# Logging in and/or Subscribing to the Service

To listen to the pay channel, you must log in to Yamaha MusicSoft and/or subscribe to the service. You can log in and/or subscribe to the channel from the Information pop-up window below.

(If you have not logged in and/or not subscribed)

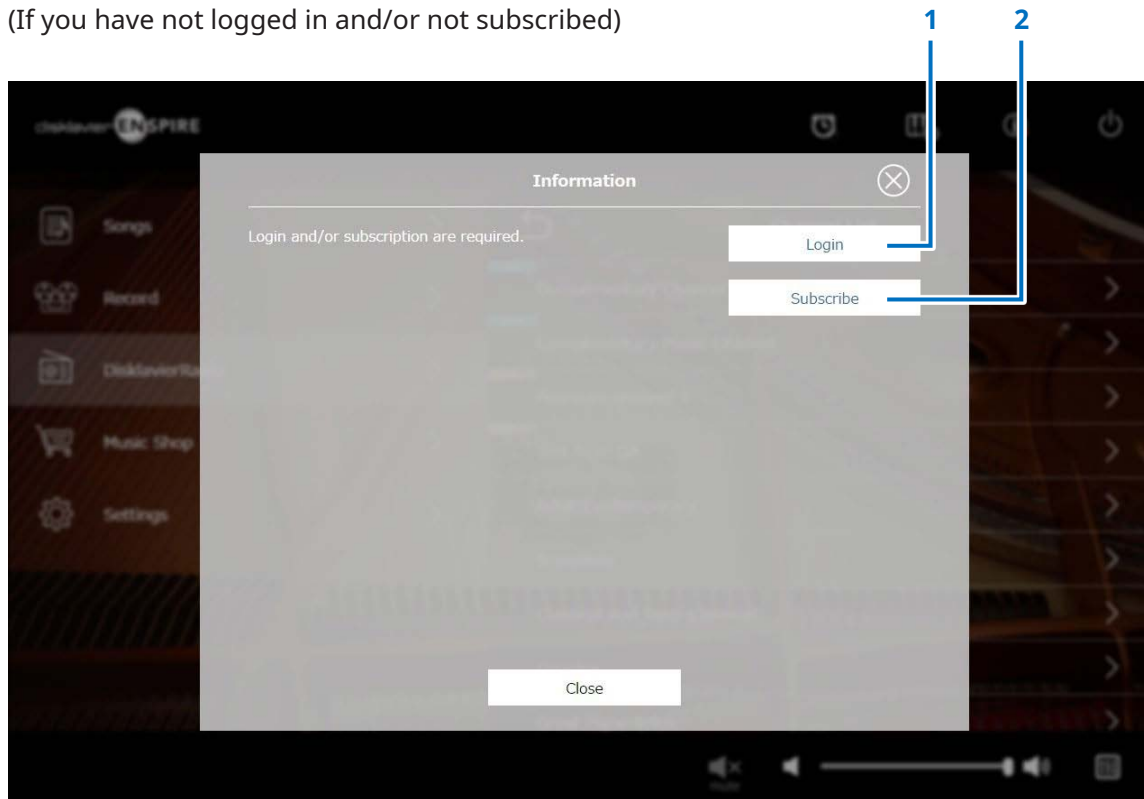

## 1 Login

Opens the Login pop-up window, letting you log in to Yamaha MusicSoft. You need to enter your e-mail address and password.

## 2 Subscribe

Opens the subscription page on the Yamaha MusicSoft website in a separate browser tab.

# Logging in and/or Subscribing to the Service

---

(If you have not subscribed)

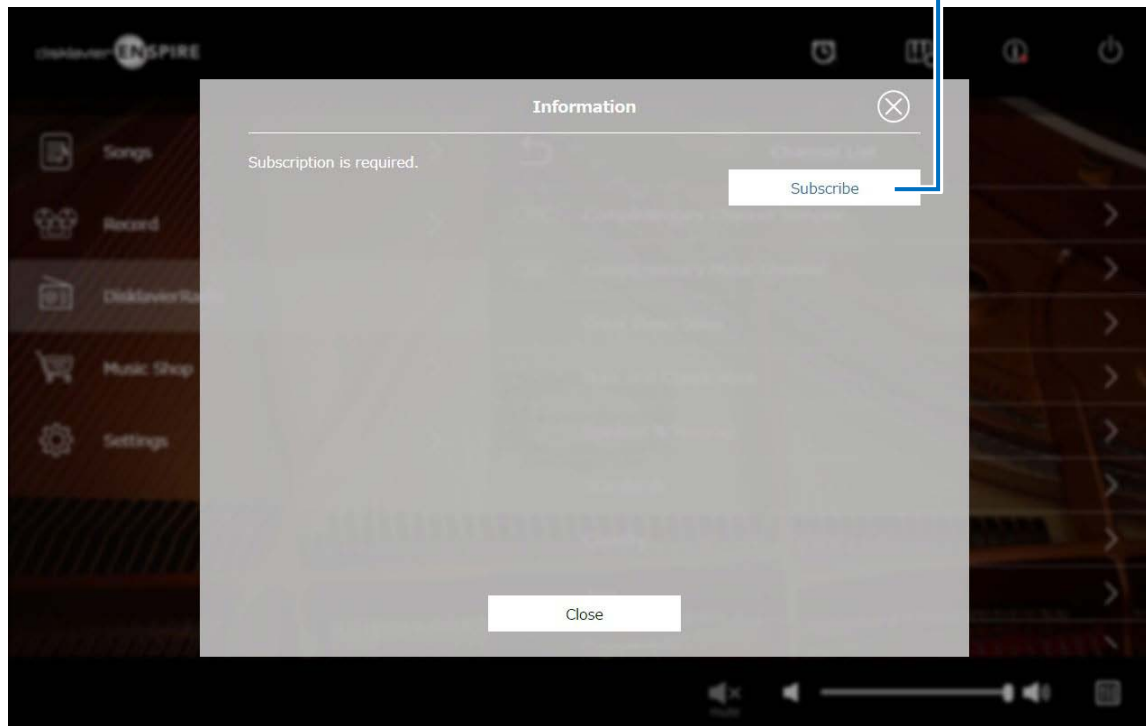

## 1 Subscribe

Opens the subscription page on the Yamaha MusicSoft website in a separate browser tab.



# DisklavierRadio Playback Screen

Selecting the channel calls up the DisklavierRadio Playback screen.

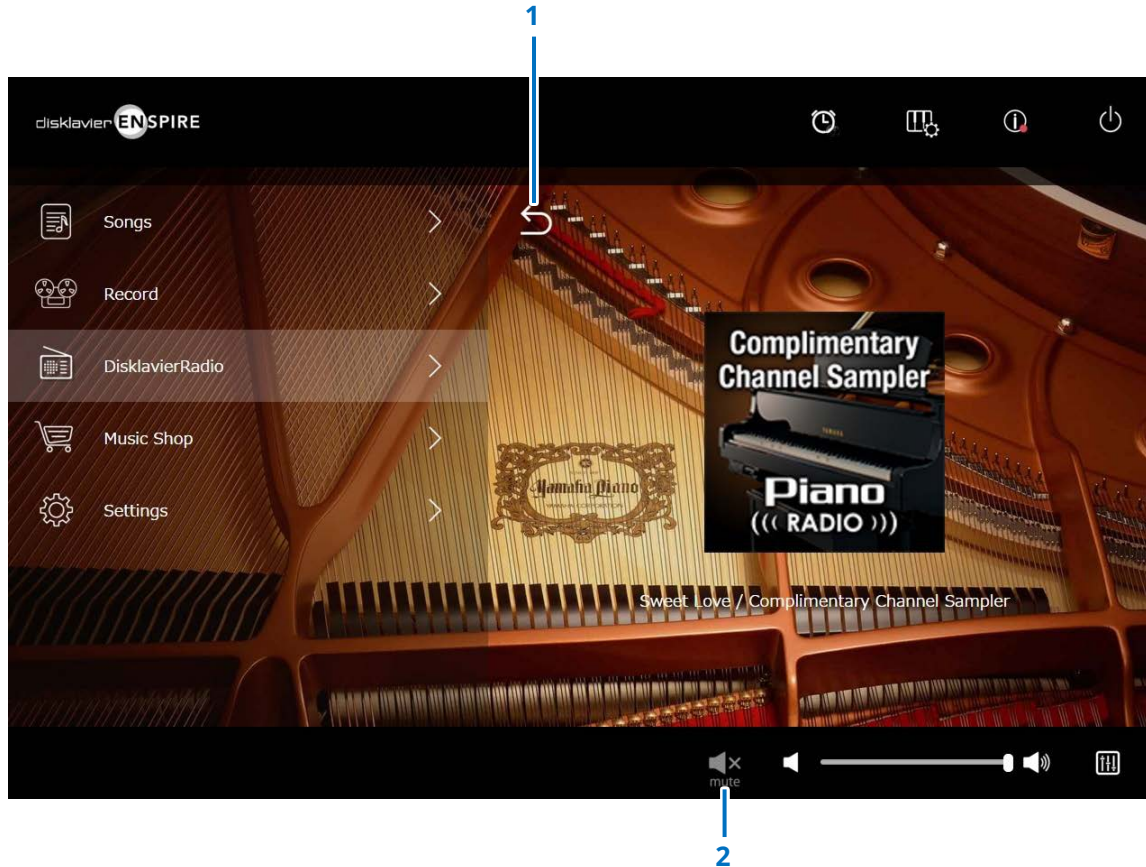

## 1 Return

Returns to the DisklavierRadio screen.

## 2 Play/Mute

Mutes or unmutes DisklavierRadio playback.

# Music Shop Screen

You can purchase and download song data from the Yamaha MusicSoft website if you have an Internet connection and a USB flash drive connected to this product. The downloaded song data will be saved to the USB flash drive.

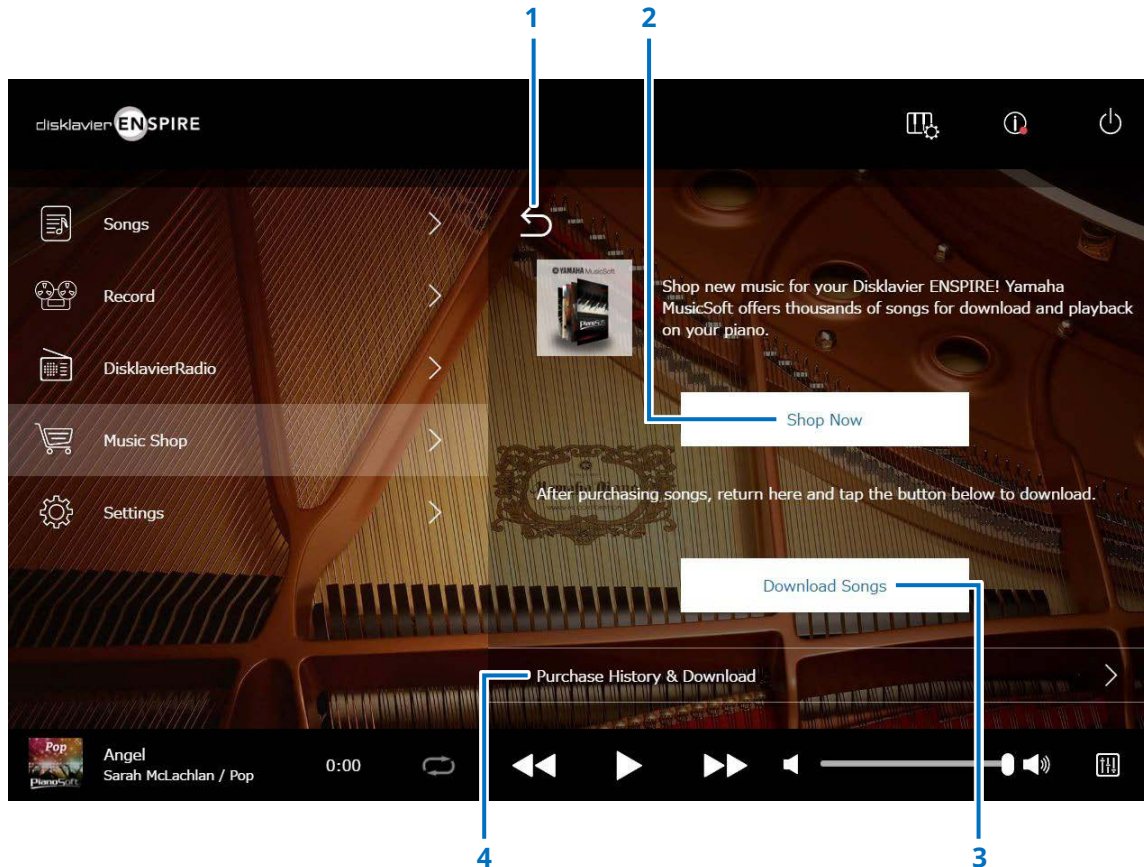

## 1 Return

Returns to the previous (higher level) screen.

## 2 Shop Now

Accesses the Yamaha MusicSoft website.

### NOTE

If you select "Direct Wireless Connection" for the network connection method, you cannot purchase or download song data from the shop screen because the Internet connection is not available.

If this occurs, change the connection method or use a separate computer to purchase from the Yamaha MusicSoft website.

## 3 Download Songs

Downloads the last purchased Song data.

Last purchased Songs will be downloaded to the folder "Songs" > "My Songs" > "Downloaded Songs."

## 4 Purchase History & Download

Confirms the purchase history and downloads any Song data that has not yet been downloaded to USB flash drive.

[page 35](#)

### NOTE

In order to download song data, you will need the e-mail address and password you registered with Yamaha MusicSoft.

# Purchase History & Download Screen

Tapping the Purchase History & Download button calls up the Purchase History & Download screen. Songs you've previously purchased are displayed.

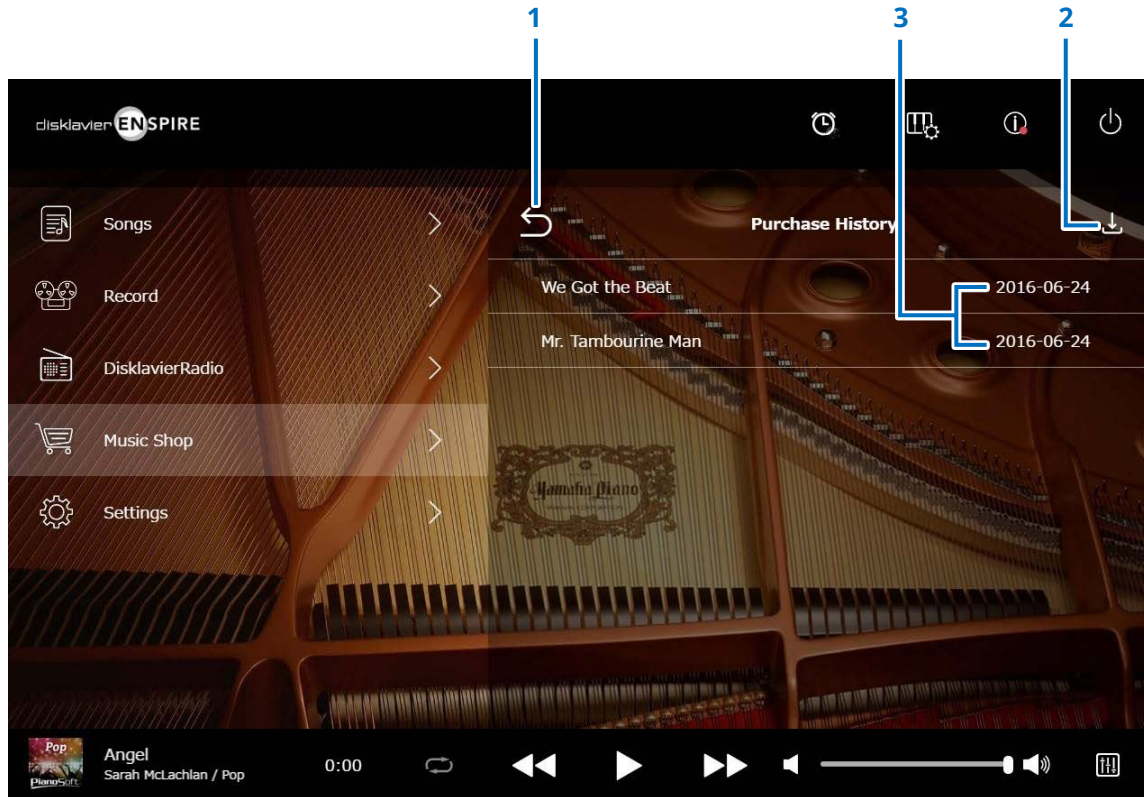

## 1 Return

Returns to the Music Shop screen.

## 2 Download

Downloads Song data not yet downloaded to USB flash drive. [page 36](#)

### NOTE

Displayed only when a USB flash drive is connected.

## 3 Purchase date

Shows the date when the Song data was purchased.



# Download Screen

Tapping the Download button in the Purchase History & Download screen calls up the Download screen.

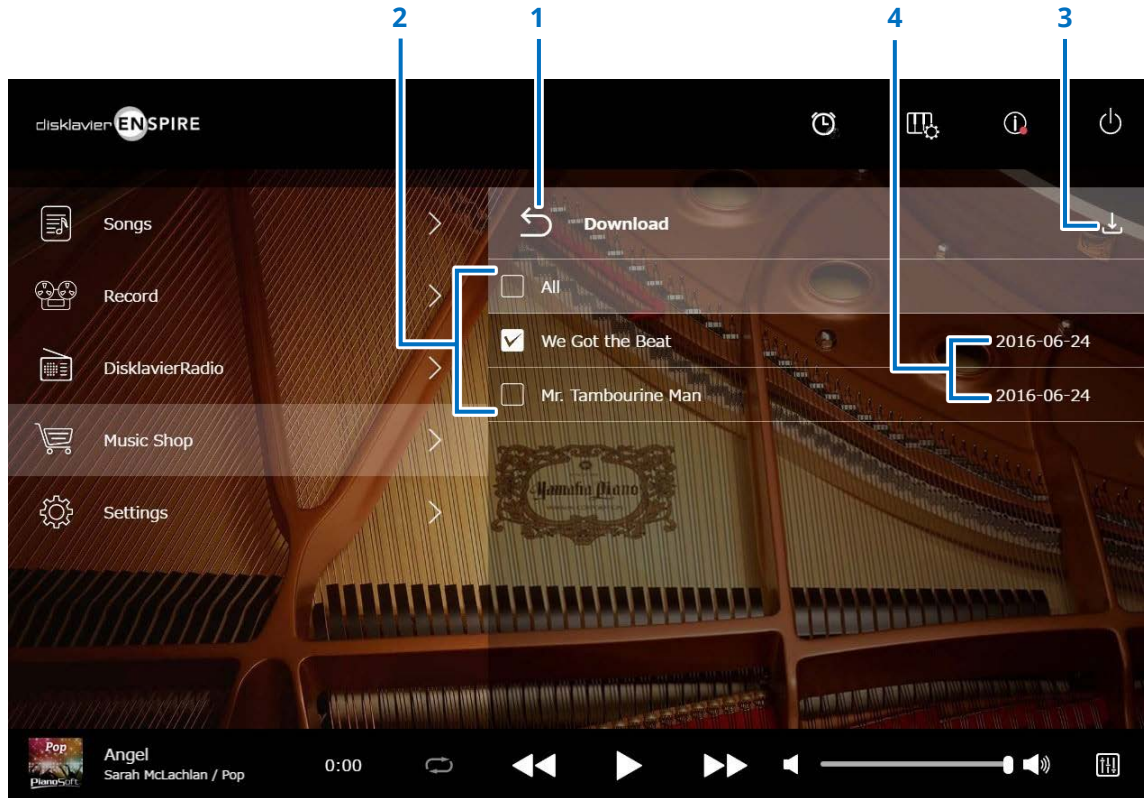

## 1 Return

Returns to the Purchase History & Download screen.

## 2 Checkbox

Appears next to Songs that have not been saved to USB flash drive. Enter checkmarks to the specific Songs you want to download to USB flash drive.

## 3 Download

Downloads the selected Song data to USB flash drive.

### NOTE

Displayed only when the USB flash drive is connected.

## 4 Purchase date

Shows the date when the Song data was purchased.

### NOTE

In order to download song data, you will need the e-mail address and password you registered with Yamaha MusicSoft.

# Settings Screen

Tapping the Settings button calls up the Settings screen.

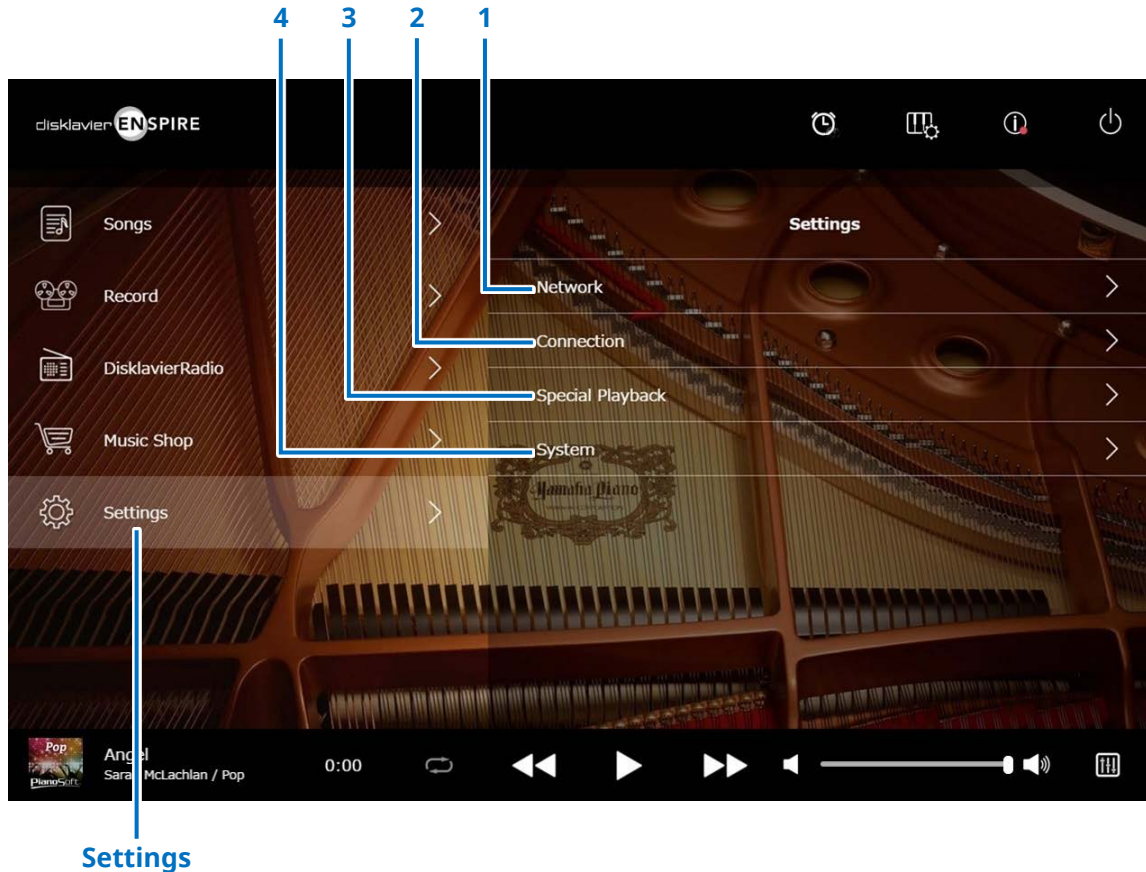

- 1 Network
  - > Wired Network [page 38](#)
  - > Wireless Network [page 38](#)
  - > Passcode [page 40](#)
- 2 Connection
  - > Audio I/O [page 42](#)
  - > MIDI I/O [page 44](#)
- 3 Special Playback [page 46](#)
- 4 System [page 50](#)

# Changing Wired / Wireless Network Connection Settings

Tapping the Wired Network/the Wireless Network button calls up the Network screen. You can change various settings related to the network connection.

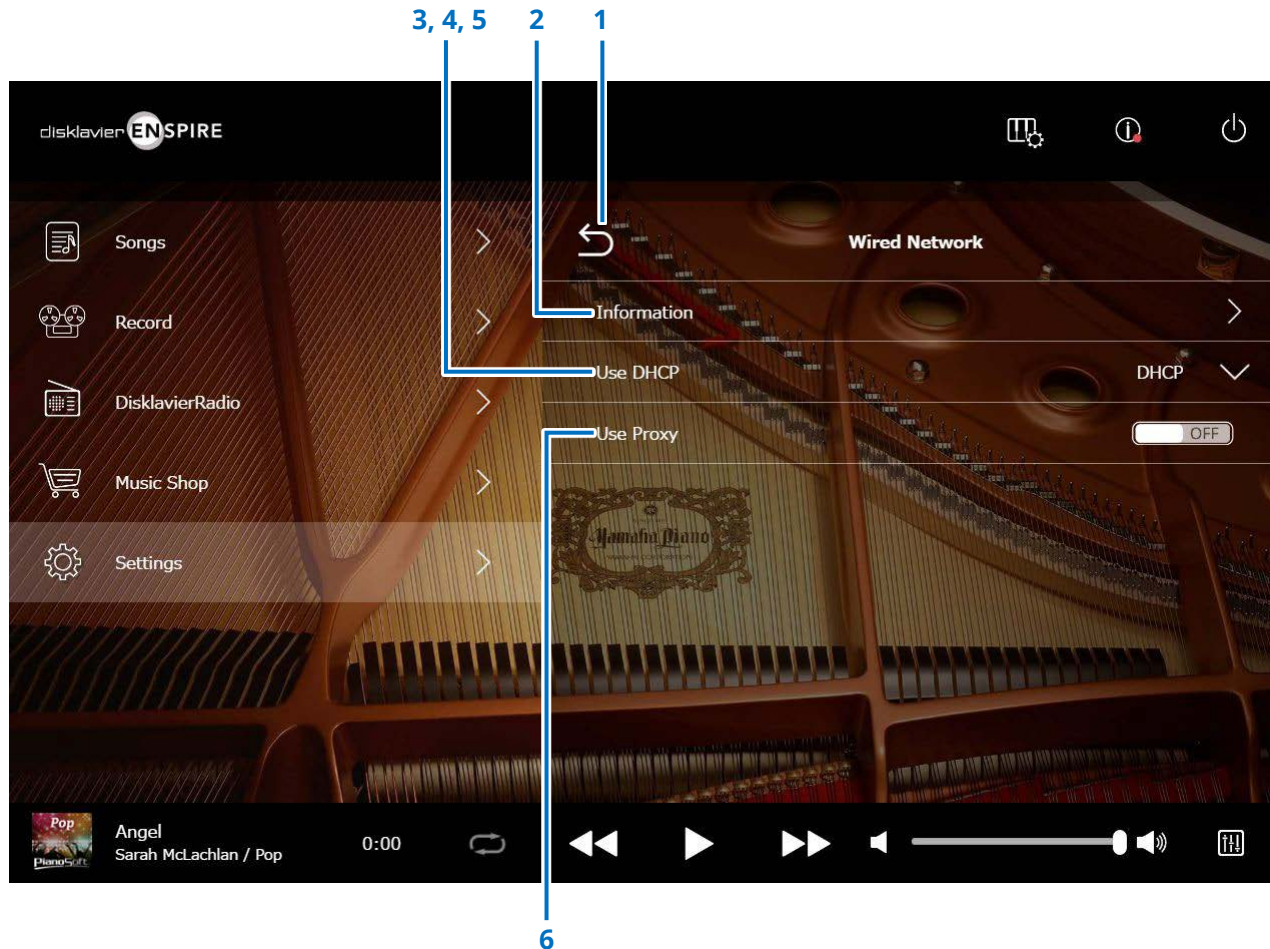

## NOTE

If you do not have a network connection, refer to "Choosing the Network Connection Method" in the operation manual of this product.

▶ Continued on next page



# Changing Wired / Wireless Network Connection Settings

---

## 1 Return

Returns to the Network screen.

## 2 Information

Calls up the Wired/the Wireless Network Information screen, letting you confirm the information of the wired/ the wireless network settings.

## 3 Use DHCP

Selects the method to determine several addresses. Selects the method to determine several addresses. If your router has a DHCP server function, we recommend selecting "DHCP" or "DHCP+DNS."

Setting "Use DHCP" to "DHCP+DNS" or "Manual" calls up the following items:  
After setting, tap the "Submit" to confirm the settings.

## 4 DNS1/DNS2

Enters the address of the primary and secondary DNS server. These settings must be made when "Use DHCP" is set to "DHCP+DNS" or "Manual."

## 5 IP Address/Subnet Mask/Gateway

Enter the address of the unit, subnet mask and gateway server. These settings must be made when "Use DHCP" is set to "Manual."

## 6 Use Proxy

Selects whether to use a proxy server or not. When set to ON, enter the name and the port number for the proxy server. These settings are necessary only when a proxy server is located in your local network.  
After setting, tap the "Submit" to confirm the settings.

### NOTE

For information about the DNS server address, IP address, subnet mask and gateway server address settings, contact your Internet service provider.

# Setting the Disklavier for the Passcode

You can enter the 4-digit passcode to prevent unauthorized access from the commercially available external remote controller. Tapping on the Passcode button in the Network Screen calls up the Login Passcode screen.

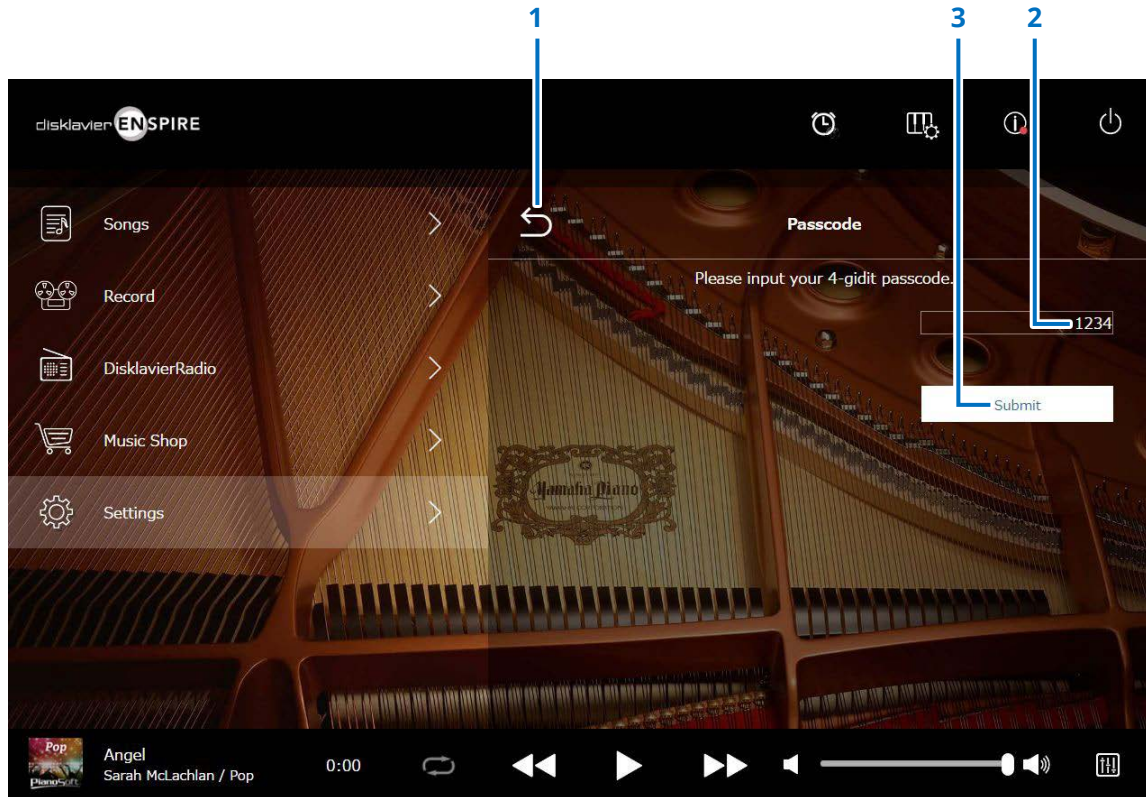

## 1 Return

Returns to the Network screen.

## 2 Input area

Sets the passcode; 4-digit number.

## 3 Submit / Reset

Submits the passcode. Resets the passcode.

# Login Passcode Screen

---

If the passcode has already been set it up, the Login Passcode screen appears for the first access time only. After approval the passcode, the Login Passcode screen is skipped until updating your passcode.



## 1 Input area

Input your passcode. The Control screen appears with approved passcode.

### NOTE

If you forget your passcode, you can reset the passcode with initializing the network setting of your Disklavier. For more details, please see the "disklavier ENSPIRE Owner's Manual."

# Setting the Disklavier for Audio Reception/Transmission

Tapping the Audio I/O button calls up the Audio I/O screen, where you can change the settings related to audio signal input/output.

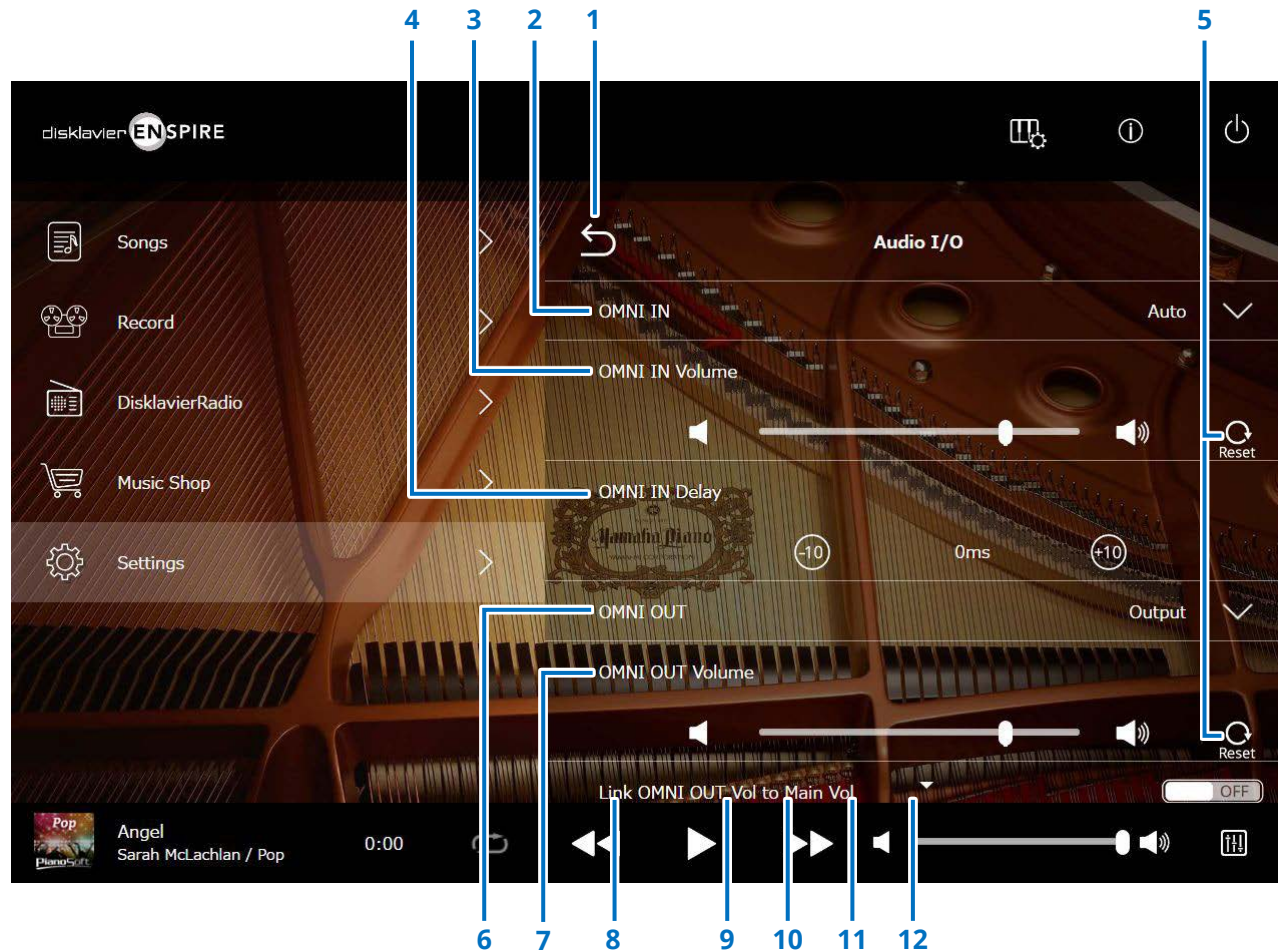

▶ Continued on next page

# Setting the Disklavier for Audio Reception/Transmission

---

## 1 Return

Returns to the Connection screen.

## 2 OMNI IN

Selects the appropriate option to match the audio input to the OMNI IN jacks.

- **Auto:** Selects this to have the Disklavier detect the input signal automatically.
- **Audio:** Plays back audio from a connected audio device and reproduces the sound from the monitor speaker(s).
- **OFF:** Cancels the audio reception to the OMNI IN jacks.

## 3 OMNI IN Volume

Adjusts the volume of the incoming audio signals to the OMNI IN jacks.

## 4 OMNI IN Delay

Adjusts the length of the offset time that leads the actual playback of the entire recording. The offset time can be set over a range of 0 ms to 500 ms. Decrease this value to delay the piano playing, and increase to advance the piano playing.

## 5 Reset

Resets the volume to its default value.

## 6 OMNI OUT

Selects the desired audio to be output from the OMNI OUT jacks.

- **Output:** Outputs the same audio signals as the ones for the monitor speaker(s)
- **Output+PianoTG:** Outputs the ensemble and piano parts
- **PianoTG:** Outputs only the piano part
- **Sync:** Outputs the SMPTE signal used for Video Synchronized Playback.
- **OFF:** Cancels the audio transmission from the OMNI OUT jacks

## 7 OMNI OUT Volume

Adjusts the volume of the outgoing audio signals from the OMNI OUT jacks.

## 8 Link OMNI OUT Vol to Main Vol

Links the OMNI OUT Volume to the main volume. When set to ON, the OMNI OUT Volume works with the main volume.

Scrolling down the screen calls up the following items:

## 9 SYNC OUT Level

Adjusts the output level of the SMPTE signal. For normal use, the adjustment of this option is not required. If noises (synchronized signal) are output from the OUTPUT jacks during Video Synchronized Playback, turn down the level and re-record.

## 10 DIGITAL OUT

Selects the desired audio to be output from the DIGITAL OUT jacks.

- **Output:** Outputs the same audio signals as the ones for the monitor speaker(s)
- **Output+PianoTG:** Outputs the ensemble and piano parts
- **PianoTG:** Outputs only the piano part
- **OFF:** Cancels the audio transmission from the DIGITAL OUT jacks

## 11 DIGITAL OUT Volume

Adjusts the volume of the outgoing audio signals from the DIGITAL OUT jacks.

## 12 Piano Delay

Applies a delay to piano playback to eliminate the delay between the output from the speakers and piano playback. The delay can be set over a range of 0 ms to 500 ms.

### NOTE

Upright pianos other than the DKC-900 do not have a DIGITAL OUT jack, so "DIGITAL OUT" and "DIGITAL OUT Volume" cannot be used on these pianos.



# Setting the Disklavier for MIDI Data Reception/Transmission

Tapping the MIDI I/O button calls up the MIDI I/O screen, where you can change the settings related to MIDI signal input/output.

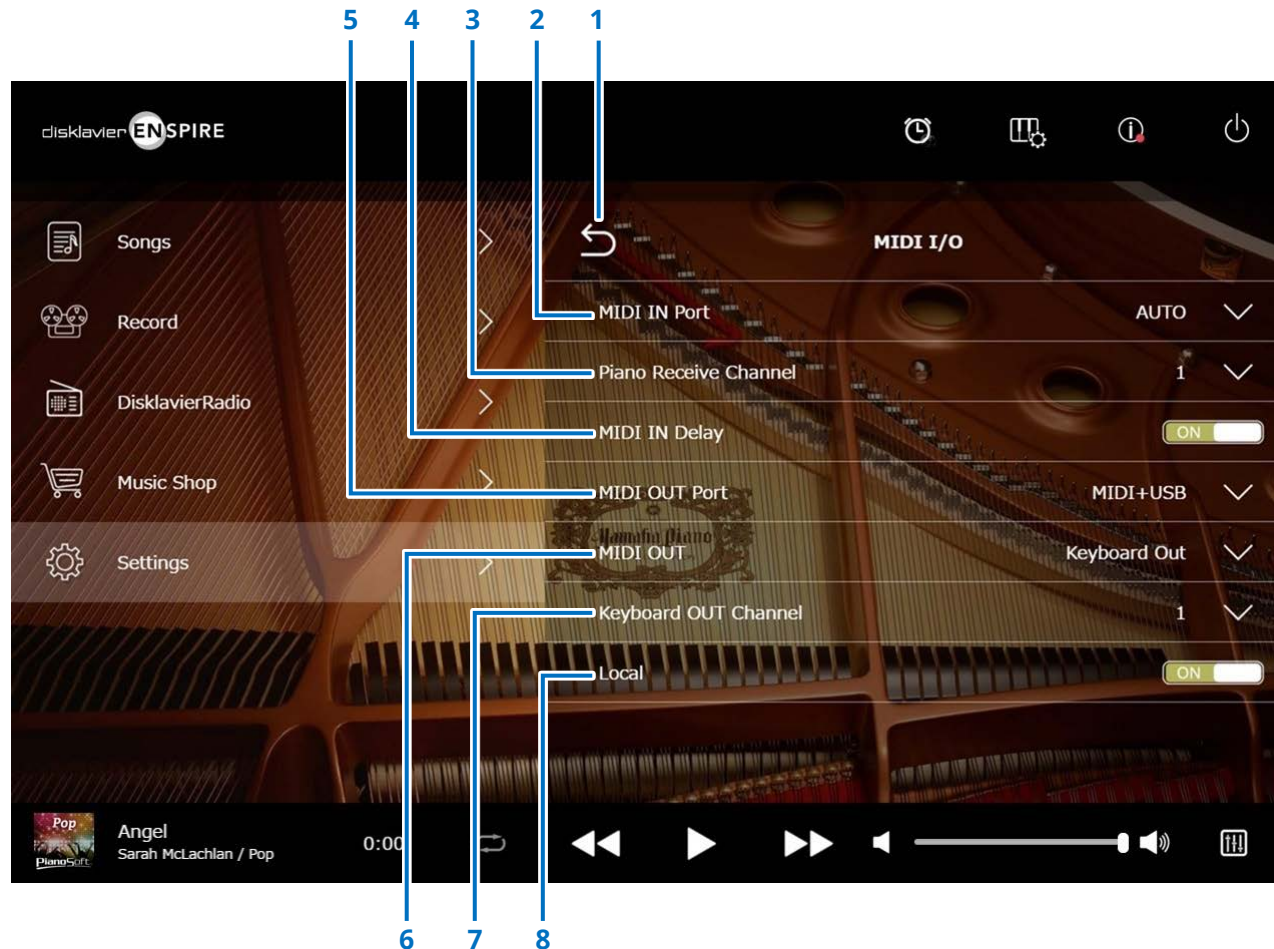

Continued on next page



# Setting the Disklavier for MIDI Data Reception/Transmission

---

## 1 Return

Returns to the Connection screen.

## 2 MIDI IN Port

Selects the jack/port used for data reception.

- **Auto:** Sets the Disklavier to detect the input signal automatically
- **MIDI:** Receives the MIDI signal from the MIDI device connected to the MIDI IN jack
- **USB:** Receives the MIDI signal from the MIDI device connected to the USB port

## 3 Piano Receive Channel

Assigns the desired channel(s) to the piano part(s) played back on the Disklavier's keyboard.

- **1-16:** Assigns the piano part to the desired channel
- **1 and 2:** Assigns the piano part to channels 1 and 2
- **Program:** Selects the smallest number channel assigned to the piano group voice to be played on the Disklavier
- **Program All:** Selects all channels for the piano group voice to be played on the Disklavier

## 4 MIDI IN Delay

Applies a delay to the incoming MIDI data to eliminate delays that may occur in producing the sound of weak and strong notes. When set to ON, a delay is applied to the incoming MIDI data so that the notes are sounded in accurate timing at 500 milliseconds after data reception.

## 5 MIDI OUT Port

Selects the jack/port used for data transmission.

- **MIDI+USB:** Transmits the MIDI signal to the MIDI device connected to the MIDI OUT jack and the USB port
- **MIDI:** Transmits the MIDI signal to the MIDI device connected to the MIDI OUT jack
- **USB:** Transmits the MIDI signal to the MIDI device connected to the USB port

## 6 MIDI OUT

Selects the parts to be transmitted to the connected MIDI device.

- **Keyboard Out:** Transmits the piano part played on the Disklavier
- **Ensemble Out:** Transmits the ensemble part played back on the Disklavier

Setting "MIDI OUT" to "Keyboard Out" calls up the following items:

## 7 Keyboard OUT Channel

- **1-16:** Assigns the piano part to the desired channel

## 8 Local

Selects whether or not the Disklavier's internal tone generator is used to reproduce the piano part.

- **ON:** Reproduces the piano part with the Disklavier's internal tone generator
- **OFF:** Reproduces the Song (played on the Disklavier) on the external MIDI device, and deactivates the internal tone generator to prevent both the internal and external tone generator from sounding at the same time.

### NOTE

Upright pianos other than the DKC-900 do not have MIDI IN or MIDI OUT terminals, so the MIDI IN and MIDI OUT ports are fixed to USB.

# Special Playback Screen

Tapping the Special Playback button calls up the Special Playback screen.

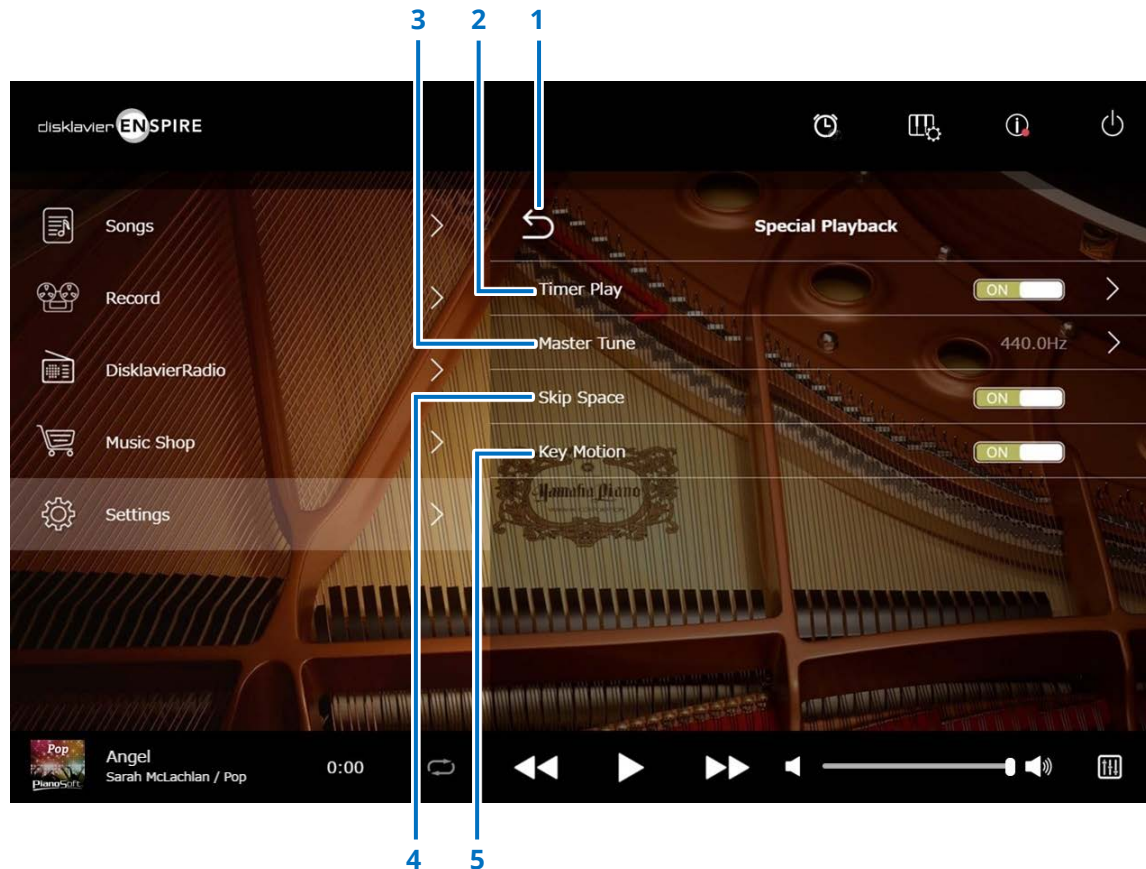

## 1 Return

Returns to the Settings screen.

## 2 Timer Play [page 47](#)

You can program your Disklavier to start or stop playback of a Song at various specified times.

When this switch is OFF, all timer settings are off.

## 3 Master Tune

Calls up the Master Tune screen. You can fine-tune the pitch of the tone generator and audio in 0.2 Hz increments, and match it to the pitch of an acoustic piano. The pitch can be adjusted over a range of 414.8 Hz to 466.8 Hz (default: 440.0 Hz). This is useful when playing the piano with other instruments.

## 4 Skip Space

Turns the Skip Space function on or off. When there is a blank part at the beginning of the Song, turning this function on automatically skips over the unwanted part and starts playback from the actual beginning of the Song.

## 5 Key Motion (Piano with SILENT Piano™ function only)

Determines whether the keys move automatically in response to song playback or not. (ON enables Key Motion.)

# Timer Play Screen

You can program your Disklavier to start or stop playback of a Song at various specified times.

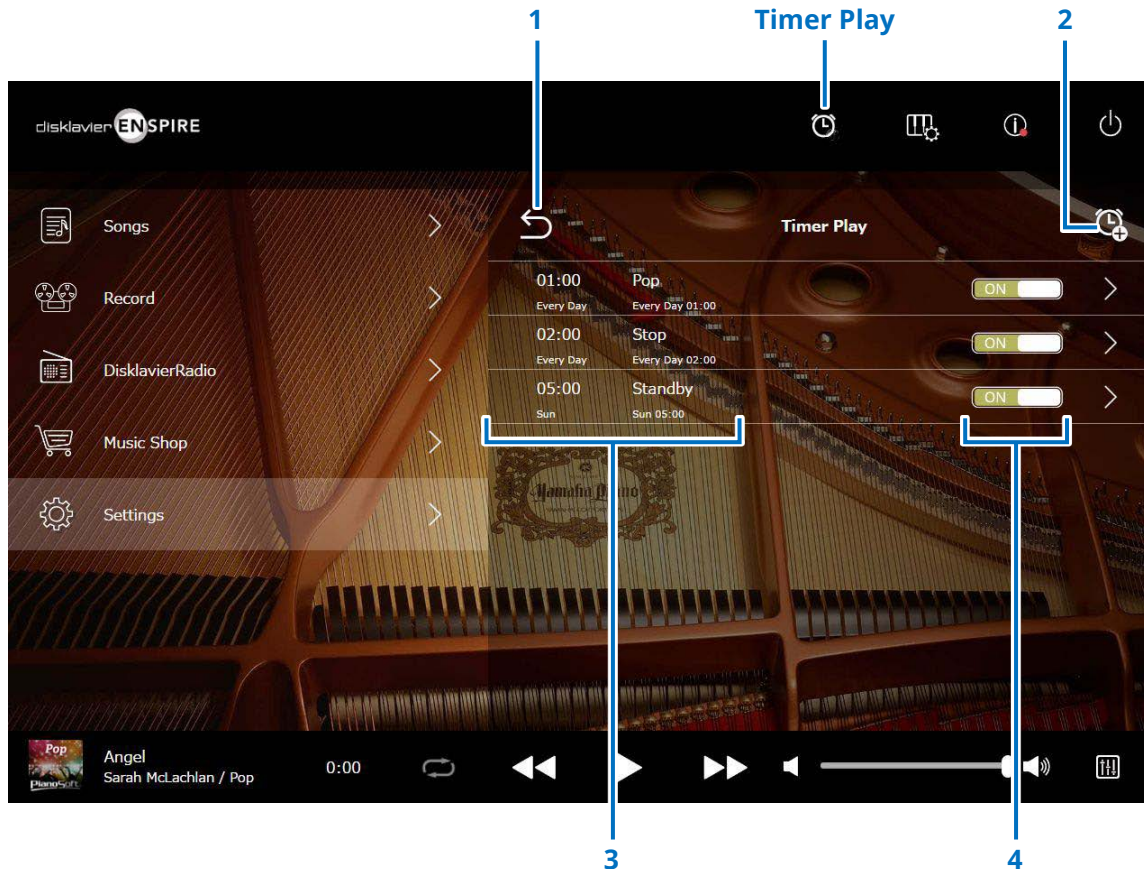

## 1 Return

Returns to the Special Playback screen.

## 2 Add the timer setting

Calls up the Timer Setting screen. [page 48](#)

## 3 Timer setting

Shows the Timer list you set in the Timer Setting screen.

## 4 On/Off setting switch

Determines whether Timer Play for the selection is on or off.

# Timer Setting Screen

Tapping the Timer Setting button  calls up the Timer Setting screen.

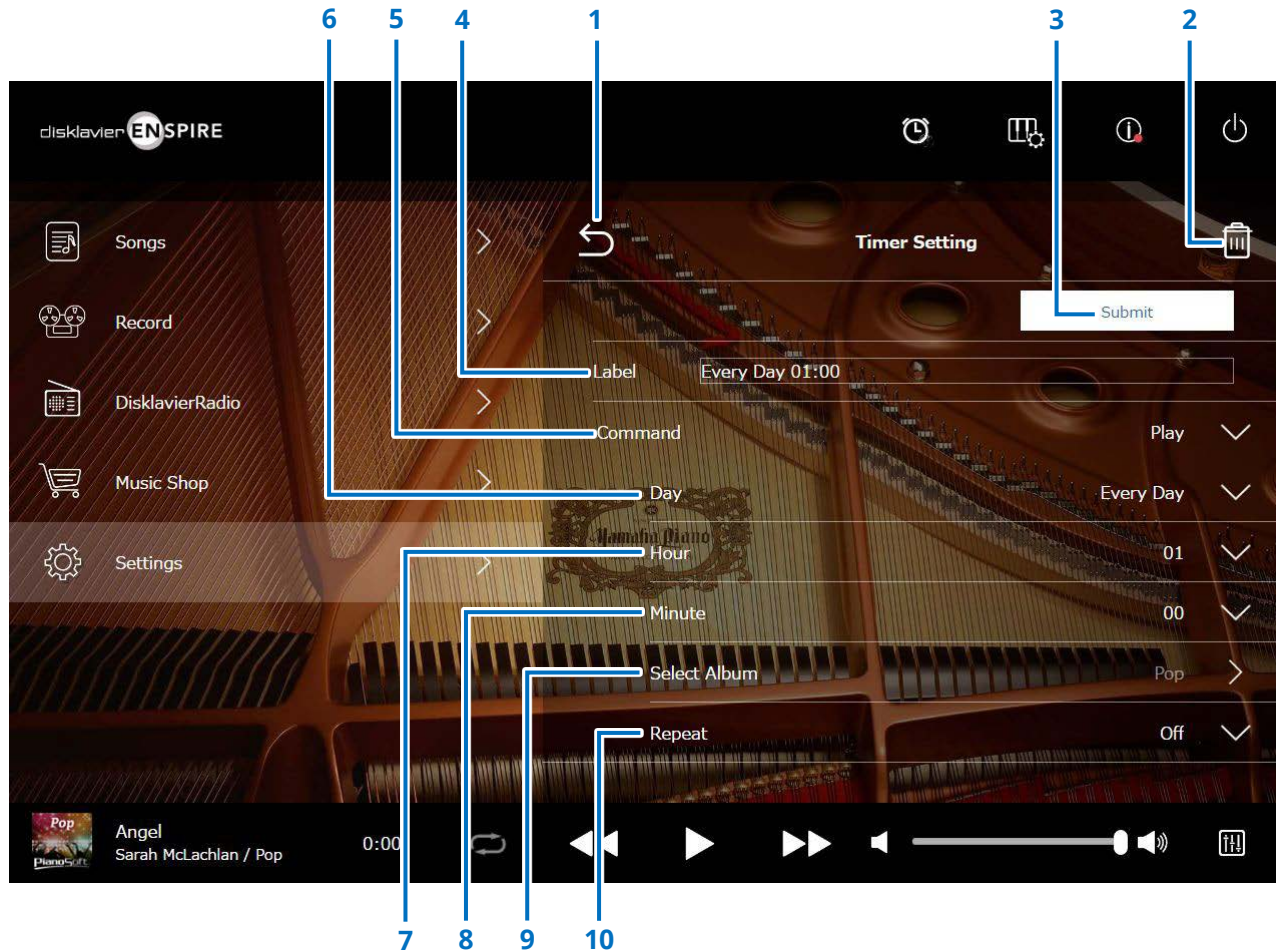

 Continued on next page



# Timer Setting Screen

---

## 1 Return

Returns to the Timer Play screen.

## 2 Delete

Deletes the selected timer setting.

## 3 Submit

Confirms the settings.

## 4 Label

Names the timer setting.

## 5 Command

Determines the action taken at the timer position.

- **Play:** Starts playback of Songs at the setting time.
- **Stop:** Stops playback of Songs.
- **Standby:** Turns off the Disklavier (standby mode).

## 6 Day

Selects the desired day.

- **Every day:** The timer play functions on every day of the week.
- **Sun – Sat:** The timer play functions only on the specified date.
- **Mon to Fri:** The timer play functions on Monday thru Friday
- **Mon to Sat:** The timer play functions on Monday thru Saturday.

## 7 Hour

Sets hours over a range of 00 to 23.

## 8 Minute

Sets minutes over a range of 00 to 59.

## 9 Select Album

Selects the desired Album.

## 10 Repeat

- **Off:** Repeats off
- **One:** Repeats the selected Song
- **Album:** Repeats all Songs in the album
- **Album Shuffle:** Shuffles all Songs in the album

# System Screen

Tapping the System button calls up the System screen.

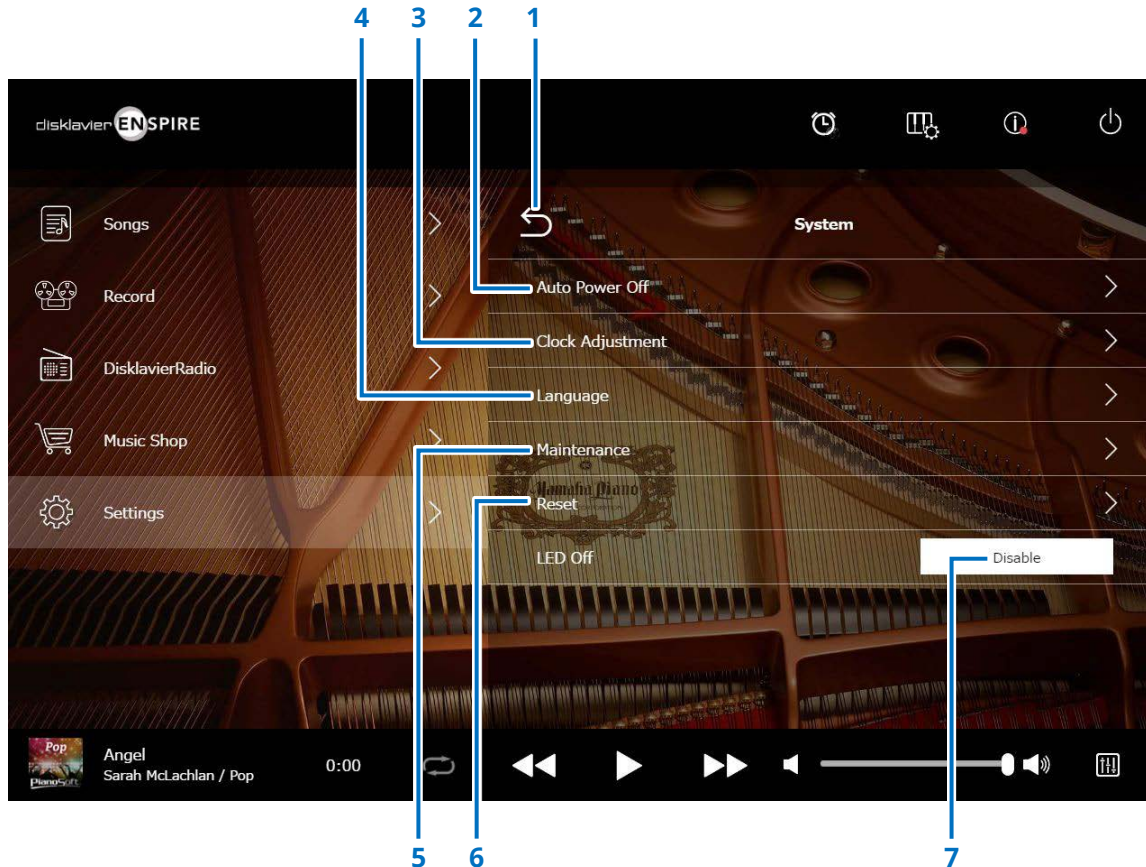

## 1 Return

Returns to the Settings screen.

## 2 Auto Power Off

Calls up the Auto Power Off screen, letting you specify the amount of time for the Auto Power Off function.

## 3 Clock Adjustment

Calls up the Clock Adjustment screen, letting you adjust the internal clock and set the time zone for your area.

## 4 Language

Calls up the Language screen, letting you switch the language for the app screen between English and Japanese.

## 5 Maintenance

Calls up the Maintenance screen. Diagnostic operations may be occasionally required. If so, perform the diagnostics from this screen.

### NOTE

Do not execute the diagnostics from the Maintenance screen on your own, without receiving instructions from qualified service personnel.

## 6 Reset

Opens the Reset pop-up window, letting you reset your Disklavier to its initial factory settings.

## 7 LED Off

Determines whether LED light on the switch box is on (LED off function is Disable) or off (LED off function is Enable.)



# Screen Layout in Portrait View

Menu screen

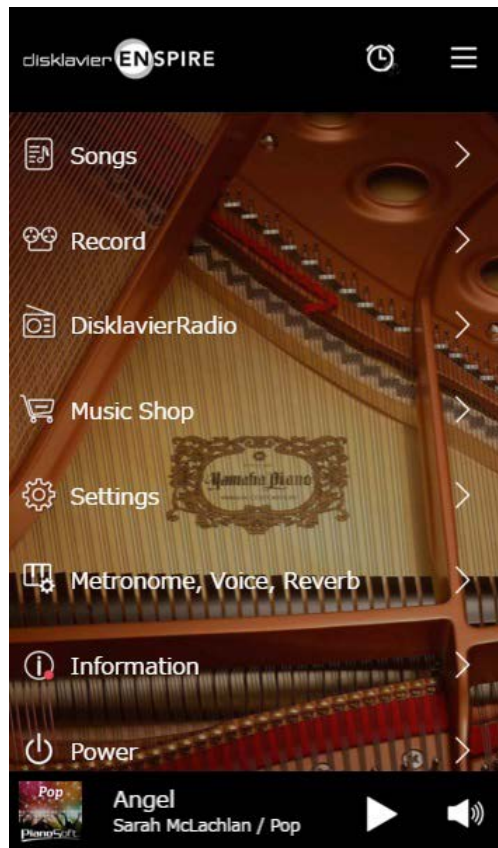

The upper area includes the following controls:

- **Logo:** Calls up the Menu screen
- **Timer:** Calls up the Timer Play screen [page 47](#)
- **Menu:** Calls up the Menu screen

The middle area includes the following controls:

- **Songs:** Calls up the Songs screen [page 19](#)
- **Record:** Calls up the Recording Standby screen [page 23](#)
- **DisklavierRadio:** Calls up the DisklavierRadio screen [page 30](#)
- **Music Shop:** Calls up the Music Shop screen [page 34](#)
- **Settings:** Calls up the Settings screen [page 37](#)
- **Metronome, Voice, Reverb:** Calls up the Playing Function screen [page 6](#)
- **Information:** Calls up the Information screen [page 11](#)
- **Power:** Turns the power off (sleep)

The lower area includes the following controls:

- **Loaded Song information:** Shows information of the loaded Song [page 5](#)
- **Play/Pause:** Starts or pauses playback [page 5](#)
- **Volume:** Adjusts the volume and balance [page 5](#)

# Screen Layout in Portrait View

Playback screen

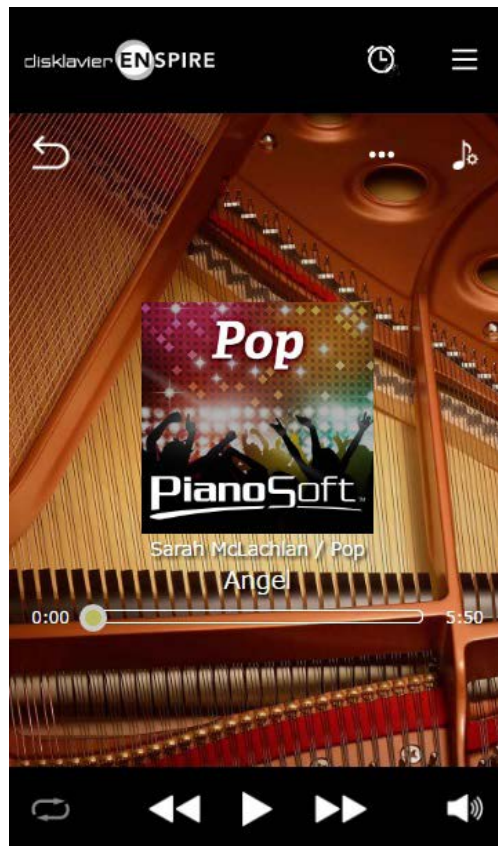

The Playback screen shows:

- Cover art (otherwise default image)
- Song title
- Artist
- Album title

The upper area includes the same controls as in the Menu screen.

The middle area includes the following controls:

- **Return:** Returns to the previous (higher level) screen [page 5](#)
- **Editing:** Calls up the Editing screen [page 22](#)
- **Practice Function:** Calls up the Practice Function menu [page 14](#)
- **Song position:** Indicates the playback position [page 5](#)

The lower area includes the following controls:

- **Repeat:** Opens the Repeat setting menu [page 5](#)
- **Skip back/Rewind:** Skips to the previous Song or rewinds through the current Song [page 5](#)
- **Play/Pause:** Starts or pauses playback [page 5](#)
- **Skip/Fast forward:** Skips to the next Song or fast-forwards through the current Song [page 5](#)
- **Volume:** Adjusts the volume and balance [page 5](#)

# Troubleshooting

If you are having difficulty operating the Disklavier, see if any of the symptoms listed below apply to your problem and follow the recommended remedy.

## Monitor Speaker

Symptom	Remedy
No sound is heard from the monitor speaker.	Make sure that the POWER switch on the monitor speaker is turned on.
	Make sure that the monitor speaker is connected to the OUTPUT jacks on the control center unit with the supplied speaker cord.
	Make sure that the overall volume is adequately turned up.
	Make sure that "Ensemble TG Volume" and "Audio Volume" are adequately turned up.

## Playback

Symptom	Remedy
The Disklavier cannot read a Song file.	Make sure that the name of the SMF Song has the extension of ".mid" and the Audio Song has ".wav" or ".mp3."
	Check the number of the albums in one category. The maximum number of the readable albums in one category is 499.
	Check the number of the Songs in an album. The maximum number of the readable Songs in an album is 999.
	Check the number of the folder directory. The unit can recognize folders up to the third directory.
Songs are played back at the wrong tempo.	Check the tempo setting.
Songs are not played back in the normal Song order.	Make sure that the shuffle repeat mode is off.
Some notes drop out during playback.	When a Piano Song is played back at a low volume, complex note trills and faint pianissimo passages sometimes drop out. If so, increase the Disklavier's volume level.
The damper does not operate during playback.	Make sure that the pedal part is not canceled.
	If a song that uses heavy pedaling is played back continuously for a long time, this unit may overheat, and the protection circuit may be activated, and pedal playback may stop. If pedal playback stops, stop playback of the Song and allow the unit to rest and fully cool down.

 Continued on next page

# Troubleshooting

---

## Tone Generator

Symptom	Remedy
The ensemble parts cannot be heard during ensemble Song playback.	Make sure that "Ensemble TG Volume" is set to an appropriate level and readjust it if necessary.
The pitch of the Disklavier and the internal tone generator do not match.	Use "Master Tune" to tune the internal tone generator.

## Connection with External Devices

Symptom	Remedy
The Disklavier cannot send or receive MIDI data with other MIDI instruments.	Make sure that the MIDI cables or USB cable are connected properly.

# Troubleshooting

## Video Synchronized Recording/Playback

Symptom	Remedy
Synchronized Songs are not played back.	Make sure that the audio channels of the DVD recorder are correctly connected to the Disklavier.
	Make sure that the input and output of the DVD recorder are correctly connected to the Disklavier.
	Make sure that the "OMNI IN" option on the Disklavier is set to "Auto."
	Make sure that the "OMNI OUT" option on the Disklavier is set to "SYNC."
Noise is heard during recording.	Turn down the volume of the TV connected to the DVD recorder.
	Disconnect the left side connector of the RCA cord from the OMNI OUT (L) jack on the Disklavier. This will not affect the functionality of video synchronized recording.
Noise is heard during playback.	The level of the synchronized signal (SMPTE) from the Disklavier may be too high. Turn down the level with the "SYNC OUT Level" option and re-record.
Piano playback is not synchronized with the video.	The video picture may be delayed on the projection device. Adjust the offset time with the "OMNI IN Delay" to match the piano playing and the video picture.
The beginning of the piano performance drops out when you play back the synchronized Song.	It may take some time until the Disklavier recognizes the synchronized signal and the piano begins to play back. Select the synchronized Song in advance, and then start playback on the DVD recorder. Note that you should wait for a while before playing the piano after recording begins on the DVD recorder.