

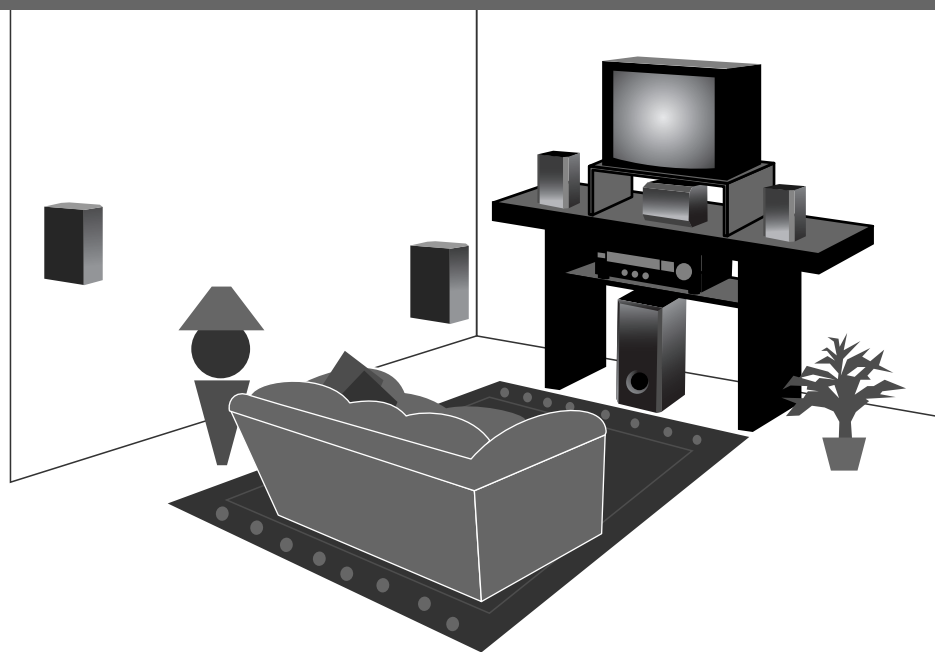

just add your TV and video source

home theater

SURROUND SOUND SYSTEM



YHT-18

QUICK-CONNECT GUIDE

INTRODUCTION

Yamaha developed the YHT-18 A/V Home Theater package to turn your home into a theater. In addition to enhancing the sound of a video source, like your TV, DVD, or VCR, the YHT-18 also superbly reproduces audio sources, such as a CD player or a cassette deck.

This Quick-Connect Guide will help you get started. Study the speaker system plan (below), and then use the interconnect diagrams (on the following pages) to connect the receiver and speakers to your system.

For the video portion, you will need a DVD player or hi-fi stereo VCR and a television or monitor. Refer to the *Yamaha HTR-5440 Owner's Manual*, as well as those that came with your other components, for complete instructions and cautions. Be sure to turn off all power while making connections.

Save this Quick-Connect Guide for future reference.

NOTE: Label the end of each speaker wire (i.e., left rear, right front, etc.) before connecting them to the A/V receiver. For wire runs over 30 feet, use larger 18- or 16-gauge speaker wire.

TOOLS AND PARTS

The YHT-18 Home Theater package consists of (1) HTR-5440 A/V receiver with (1) universal remote control, (4) 2-way NX-220P front/rear speakers, (1) NX-C220 2-way center-channel speaker, (2) 49' lengths and (3) 13' lengths of speaker wire, (1) 10' RCA audio cable, speaker mounting-bracket hardware, (1) SW-P201 Powered Subwoofer, and related owner's manuals. You will also need:

- Wire strippers (optional)
- Velcro (for secure fastening of NX-C220 on TV)
- Brackets, toggle bolts, molly anchor screws, or sheet metal screws (for securing NX-220P speakers to walls)

NOTE: If you are unsure of how to securely and safely fasten speakers to a wall, please contact a reliable source about the best type of hardware for your particular wall's construction. Secure installation is the purchaser's responsibility.

SPEAKER SYSTEM PLAN

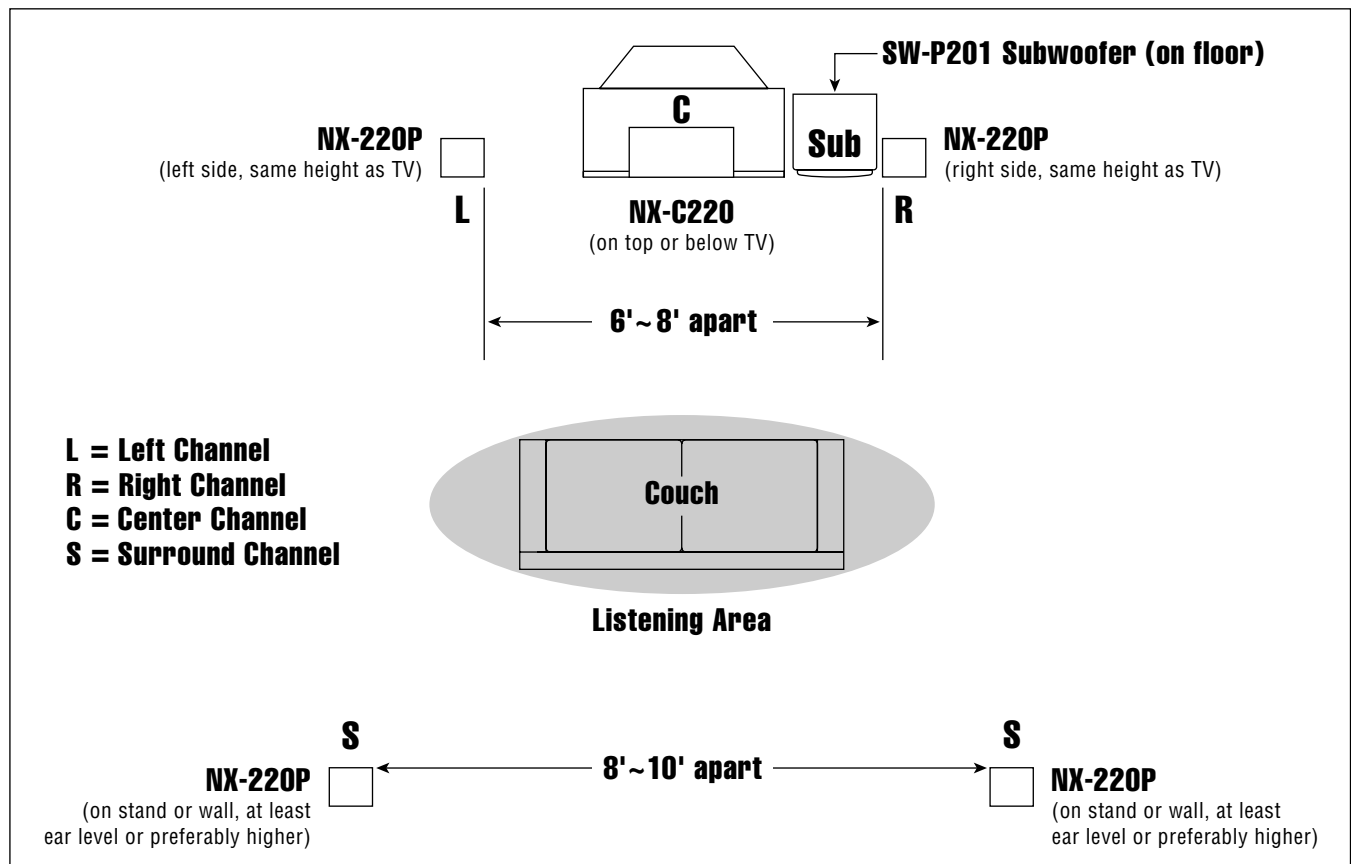

CONNECTING AUDIO COMPONENTS

Yamaha HTR-5440 Receiver (Rear Panel)

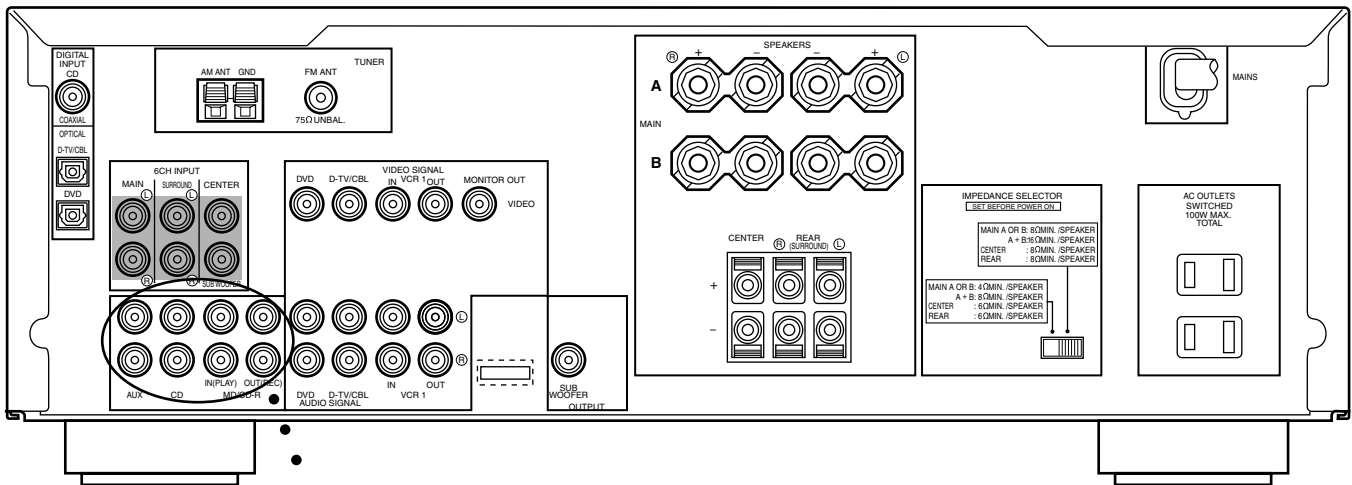

NOTE: For your convenience, the Yamaha HTR-5440 receiver is equipped with two switched ac outlets (100 W max.). If desired, use them to power on connected components (e.g., CD player) each time the receiver is turned on. However, do not use them for components equipped with clocks (e.g., VCR).

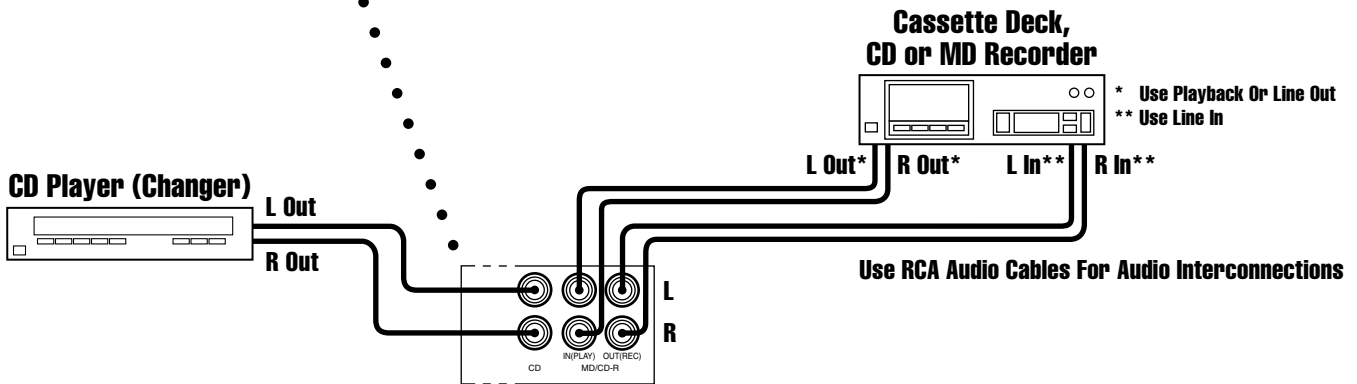

RCA Cable Color Codes
 Yellow = Video
 White = Left Audio
 Red = Right Audio

CONNECTING THE YHT-18 SPEAKERS

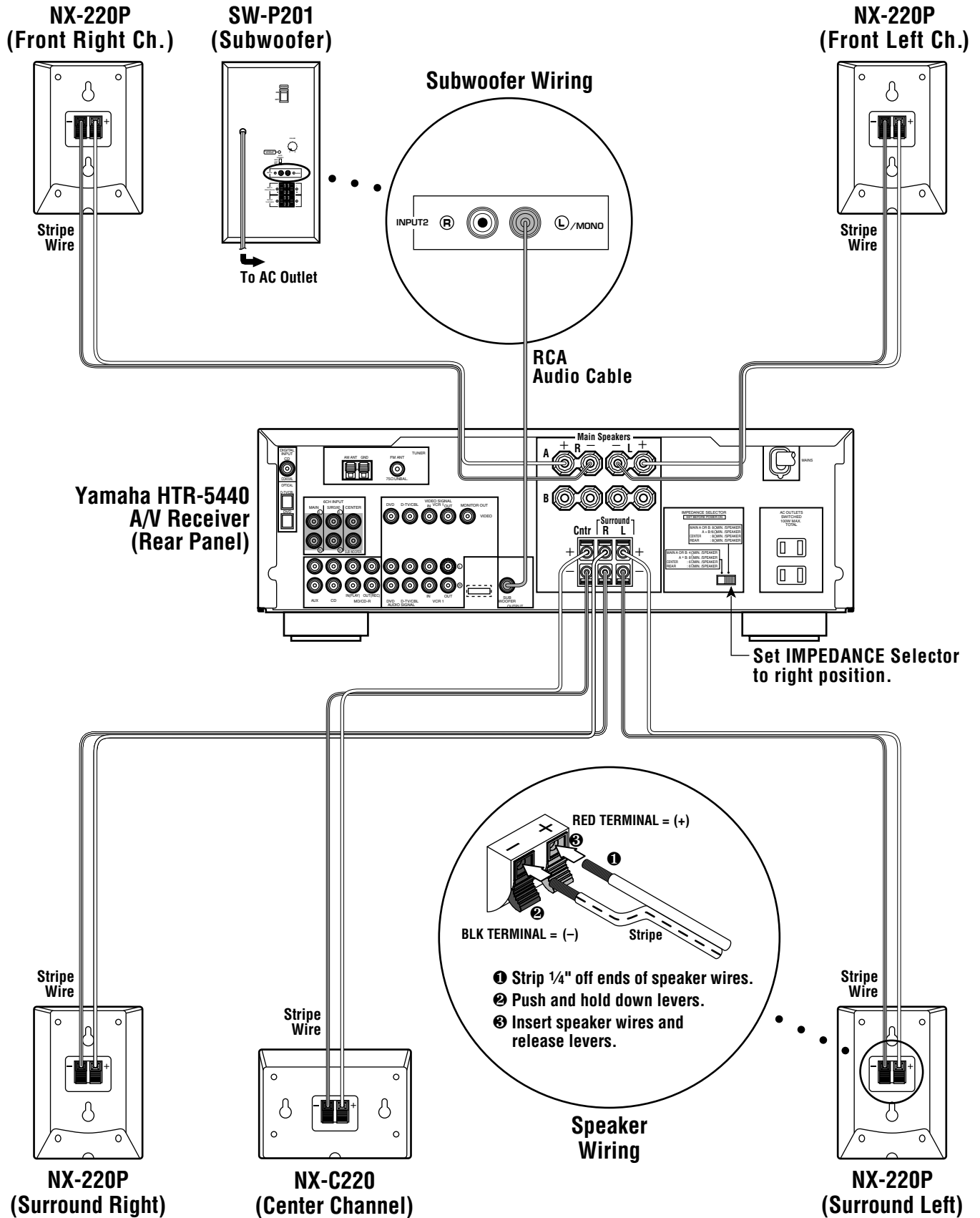

CONNECTING VIDEO CABLES FOR VIDEO COMPONENTS

Yamaha HTR-5440 Receiver (Rear Panel)

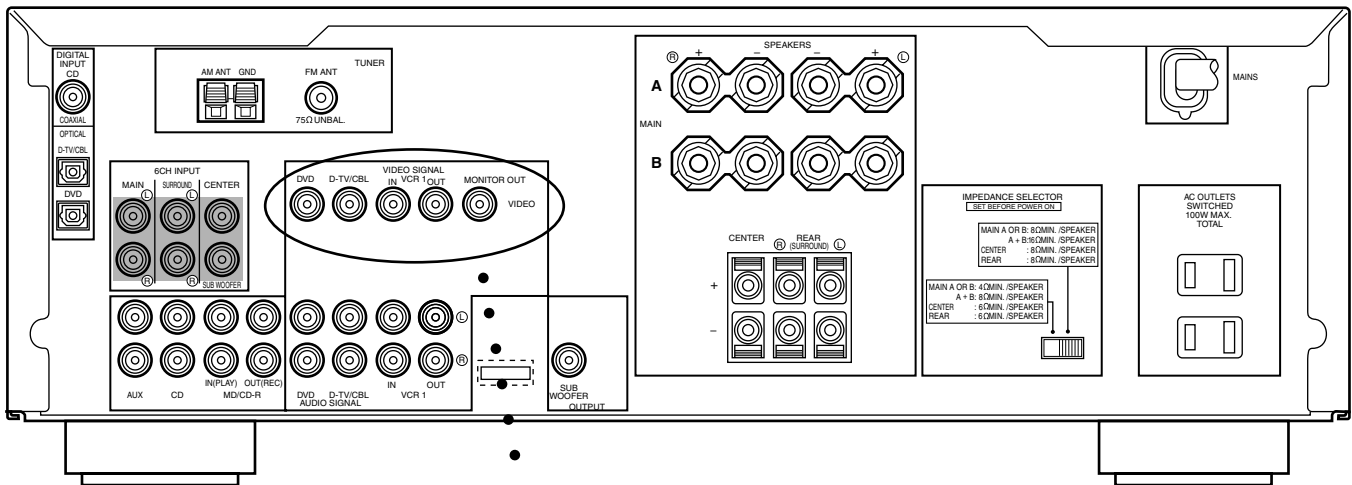

NOTE: When using a hi-fi stereo VCR, set the Tuner/Line switch (on the VCR) to Line position to record from another source connected to the Yamaha HTR-5440 receiver.

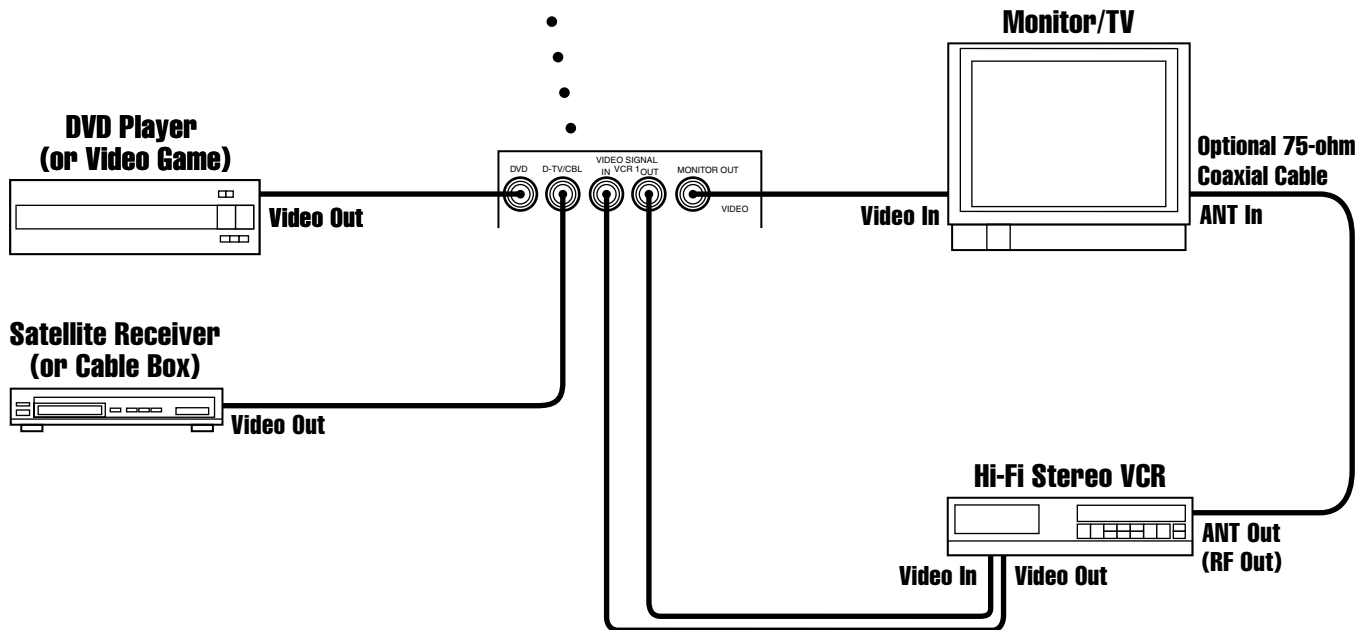

RCA Cable Color Codes
 Yellow = Video
 White = Left Audio
 Red = Right Audio

Use RCA Video Cables And Jacks For Video Interconnections

CONNECTING A DVD PLAYER

Yamaha HTR-5440 Receiver (Rear Panel)

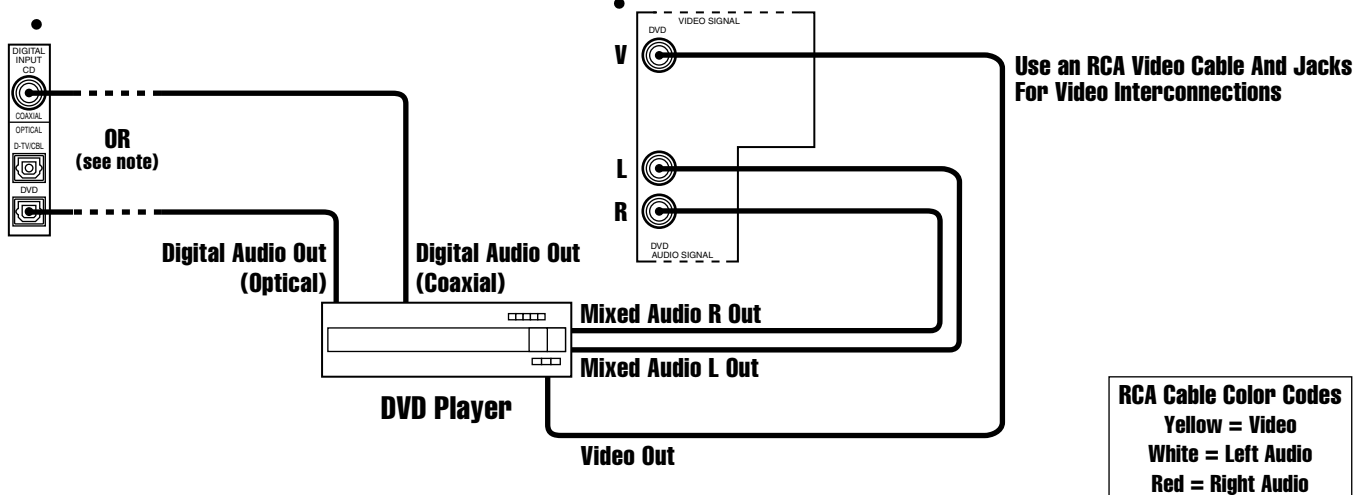
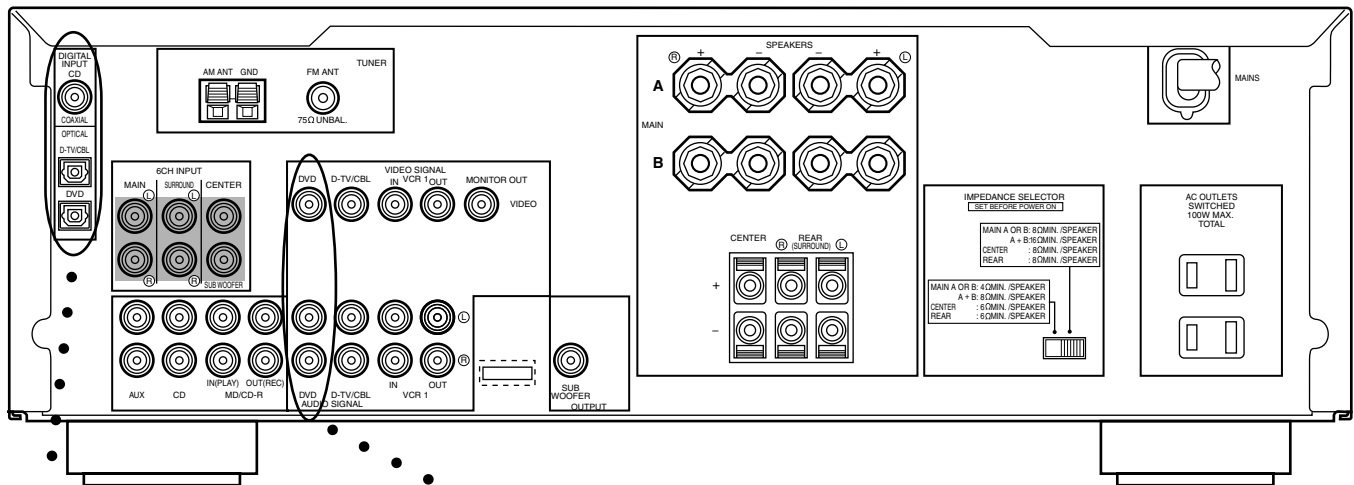

NOTE: Your DVD player may have optical and coaxial digital-audio outputs.

For optical connections, use an optical cable (available from your local audio dealer) to connect the optical output on the DVD player to the optical input, labeled DVD, on the the HTR-5440 receiver (see detail above).

For coaxial connections, use an RCA cable (available from your local audio dealer) to connect the RCA coaxial output on the DVD player to the coaxial input, labeled DIGITAL INPUT CD, on the HTR-5440 receiver (see detail above). Then rename the digital input on the HTR-5440 to "DVD" (see the HTR-5440 Owner's Manual for the procedure).

CONNECTING AUDIO CABLES FOR VIDEO COMPONENTS

Yamaha HTR-5440 Receiver (Rear Panel)

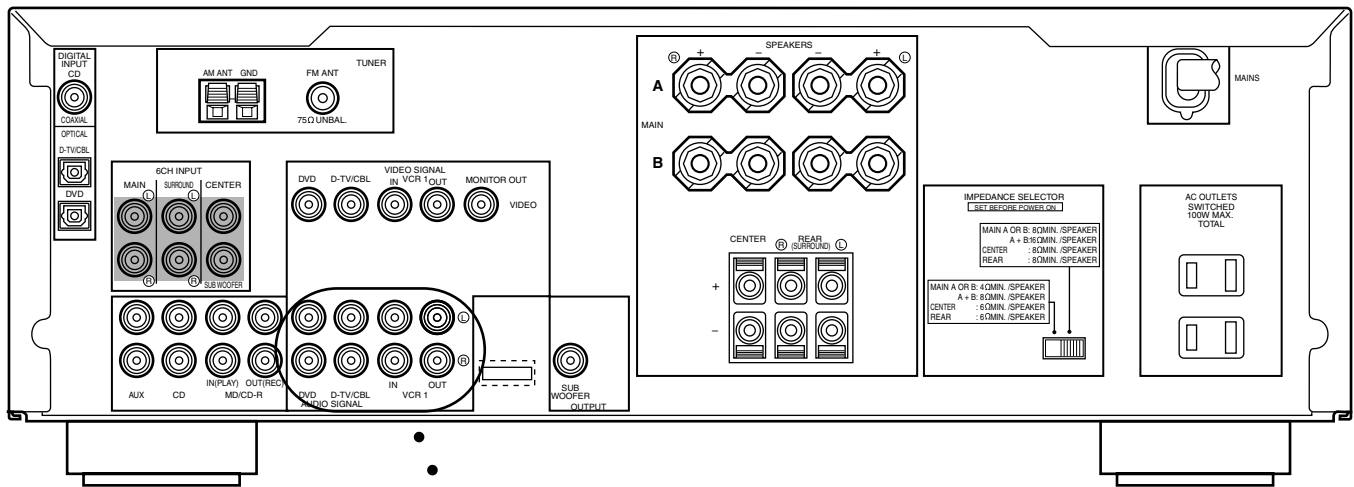

NOTE: When using a hi-fi stereo VCR, set the Tuner/Line switch (on the VCR) to Line position to record from another source connected to the Yamaha HTR-5440 receiver.

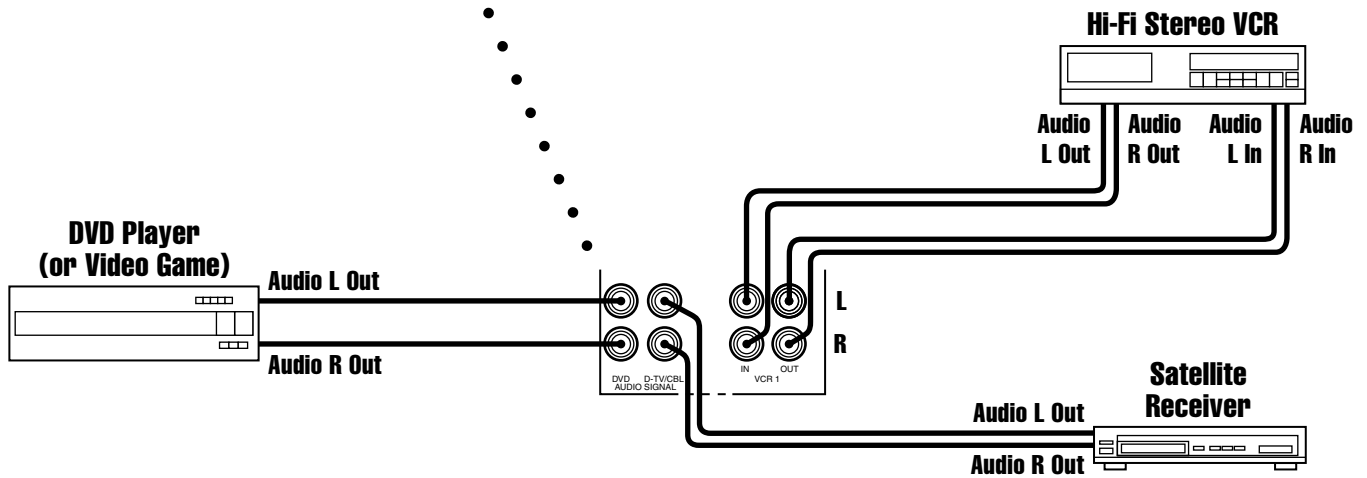

RCA Cable Color Codes
 Yellow = Video
 White = Left Audio
 Red = Right Audio

Use RCA Audio Cables And Jacks For Audio Interconnections

CABLE HOOK-UP (BASIC AND PREMIUM CHANNELS)

Yamaha HTR-5440 Receiver (Rear Panel)

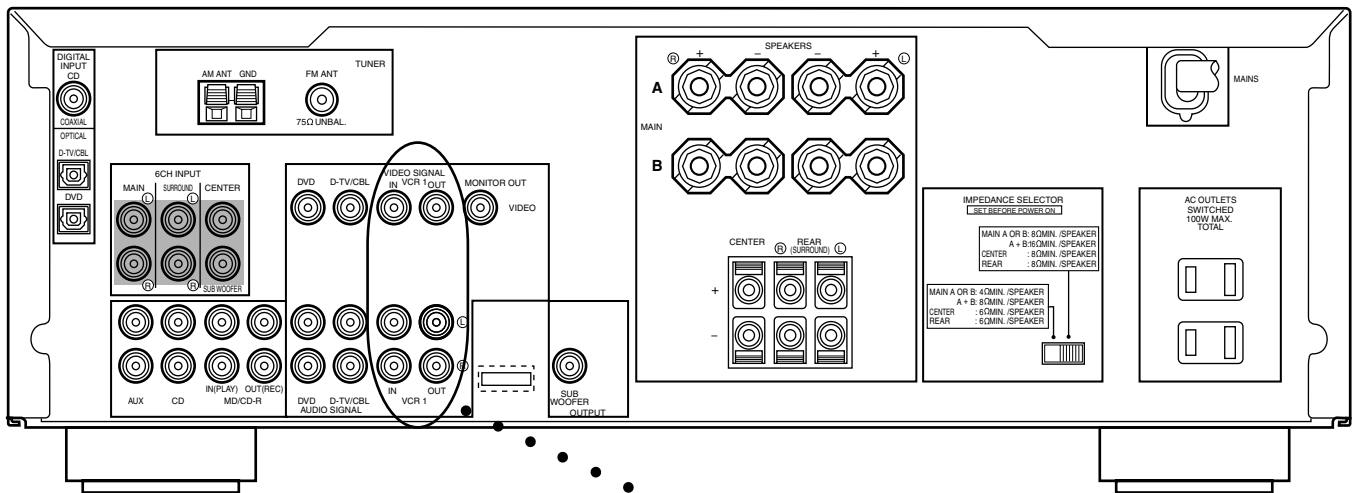

NOTE: When using a hi-fi stereo VCR, set the Tuner/Line switch (on the VCR) to Line position to record from another source connected to the Yamaha HTR-5440 receiver.

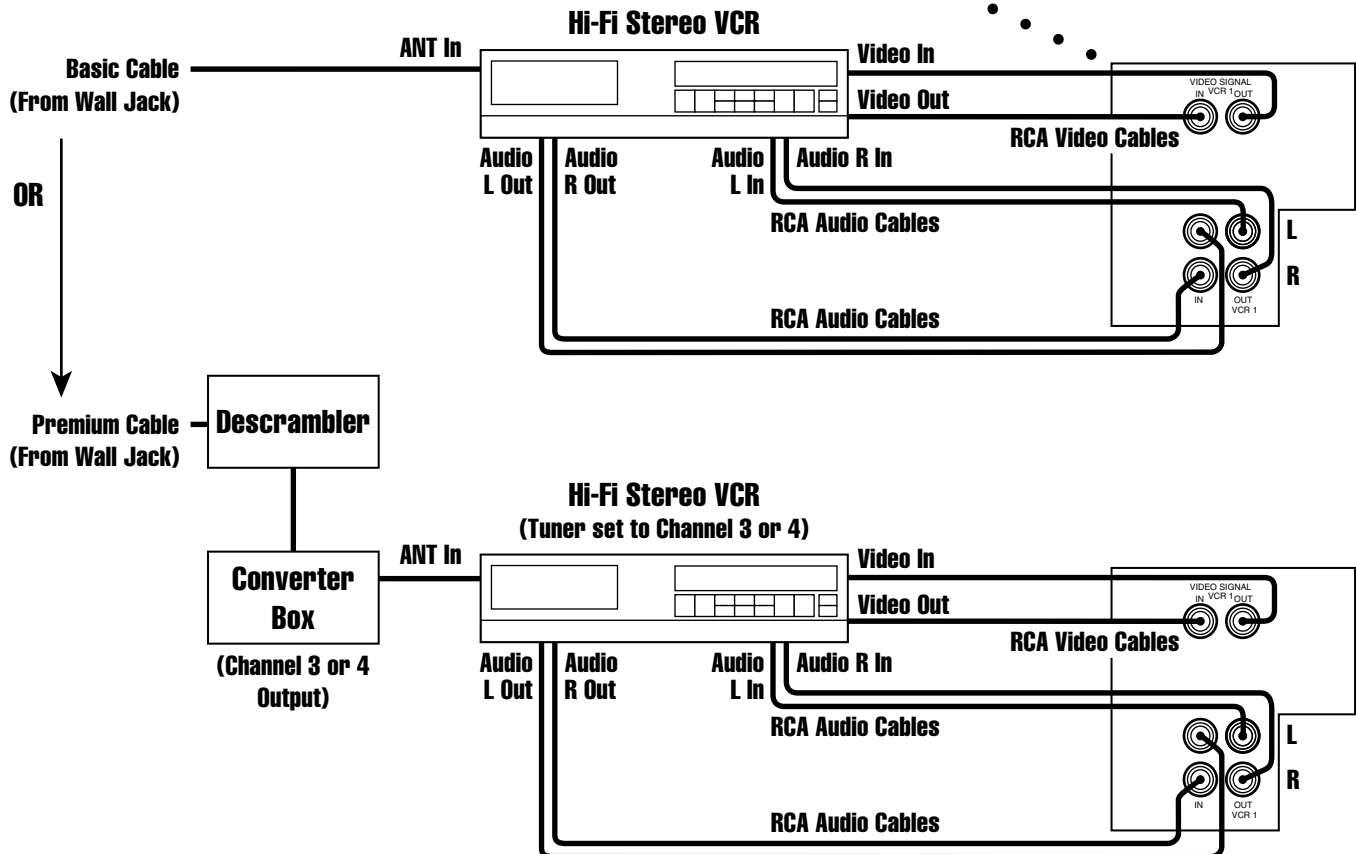

RCA Cable Color Codes
 Yellow = Video
 White = Left Audio
 Red = Right Audio

INITIAL ADJUSTMENT OF THE SW-P201 SUBWOOFER

To achieve the optimum volume balance between the SW-P201 Subwoofer and the NX-220P Main Speakers, perform the following procedure:

1. Insert the SW-P201's power plug into a nearby ac outlet.
2. Set the SW-P201's VOLUME control to 0 (minimum setting), the AUTO STANDBY switch to HIGH, and the HIGH CUT switch to LOW.
3. Press the SW-P201's POWER switch to ON and power on all other components.
4. Play an audio source and adjust the HTR-5440's VOLUME control to a desired listening level.
5. On the SW-P201, increase the volume gradually to adjust the balance the volume between the SW-P201 Subwoofer and the NX-220P Main Speakers.

NOTE: Once the volume is balanced between the subwoofer and the main speakers, you can adjust the volume of your whole sound system by using the HTR-5440's VOLUME control.

SW-P201 Subwoofer (Rear Panel)

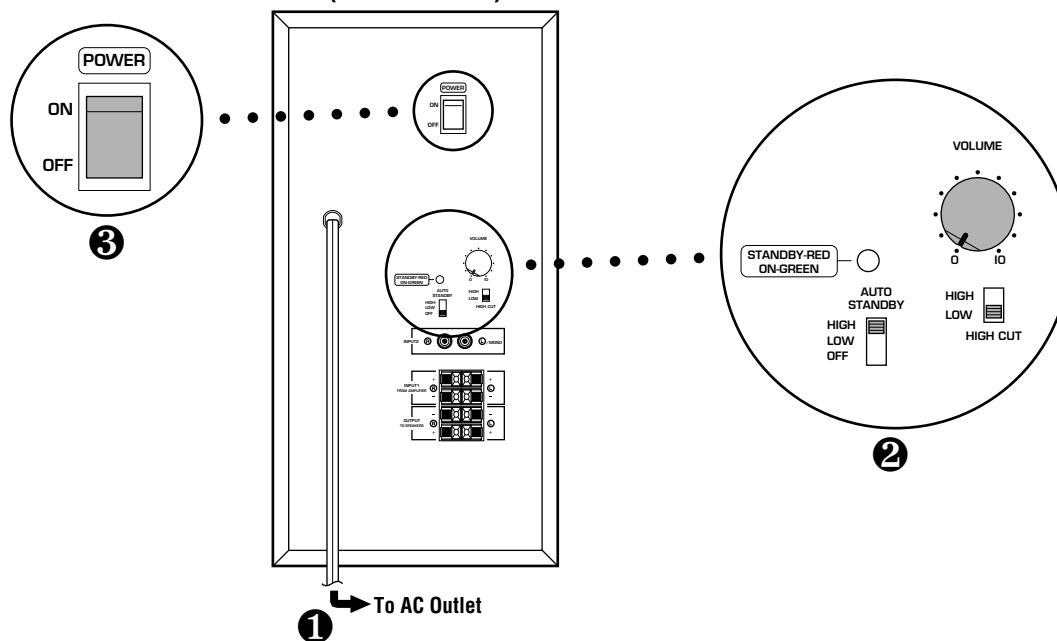

PROGRAMMING THE UNIVERSAL REMOTE CONTROL

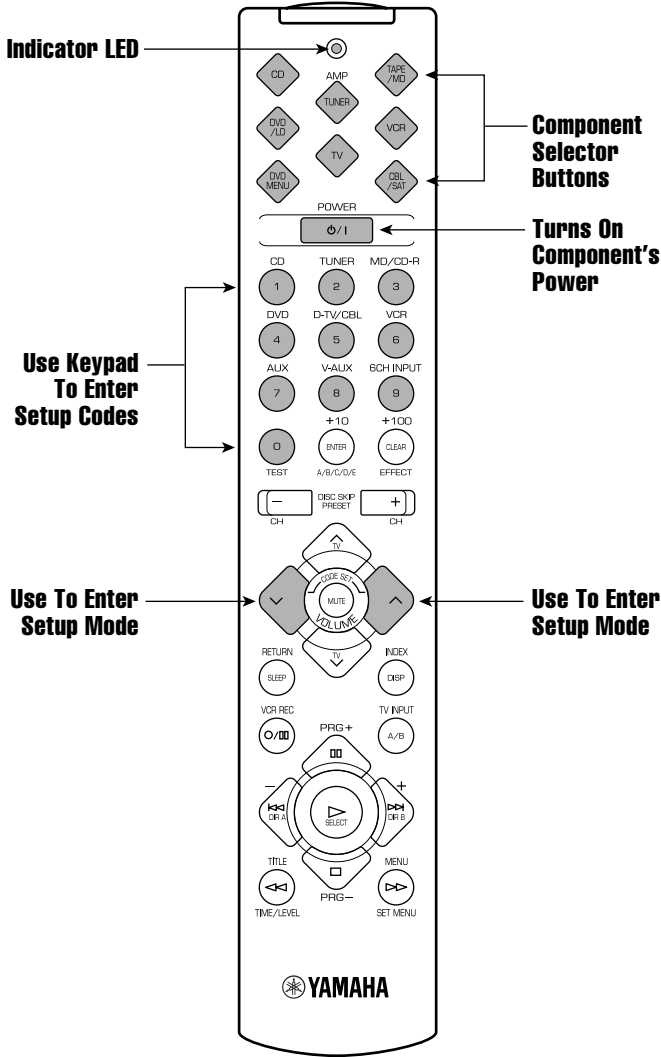

SETTING UP COMPONENTS

Perform the procedure for each component you own. At the end of each step 5, the remote control's processor will automatically assign the selected component's control functions to its own buttons, ready for your use.

SETTING UP YOUR TV

1. Turn on the television set and look up a setup code for your brand of television (codes are located at the back of the *HTR-5440 Owner's Manual*).
2. On the remote control, press TV.

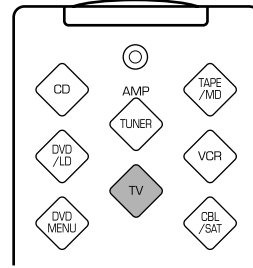

3. Press and hold both VOLUME buttons at least four seconds until the indicator LED flashes twice.

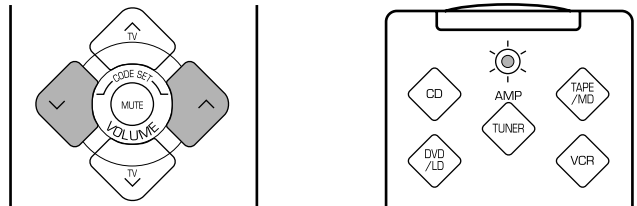

4. Using the keypad, enter the four-digit setup code. The indicator LED will flash twice after your entry. If the LED did not flash twice, repeat steps 3 and 4.

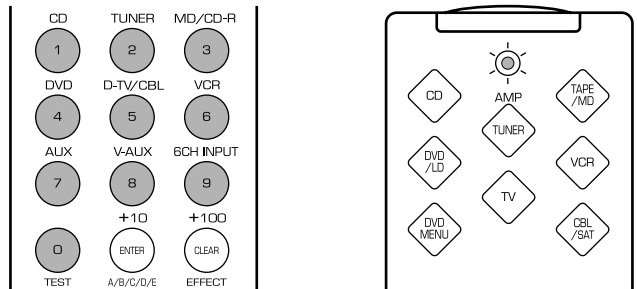

The YHT-18 Home Theater package includes a universal remote control. It comes pre-programmed with factory codes to control your HTR-5440 receiver and most Yamaha audio components. To program other brands of components (i.e., TV, VCR, etc.) or if your Yamaha unit does not respond, you will need to program the remote control with the manufacturer's codes (listed on the back pages of the *HTR-5440 Owner's Manual*).

NOTE: The universal remote control is designed to control most major brands of audio and video components. For other units, use the original remote control supplied with the product.

POWER ON

1. Load the supplied batteries into the remote control.
2. Aim the remote control at the receiver, press AMP/TUNER, and then press POWER.
3. The receiver should turn on.

5. To verify the code works, aim the remote control at the television set, press TV, and then press POWER. The television set should turn off. If it doesn't respond, use another code for the same manufacturer and repeat steps 3 through 5.

PROGRAMMING THE UNIVERSAL REMOTE CONTROL (CONTINUED)

SETTING UP YOUR CABLE BOX (OR DSS)

1. Turn on the cable box (or DSS) and look up a setup code for your brand of cable box (or DSS) (codes are located at the back of the *HTR-5440 Owner's Manual*).
2. On the remote control, press CBL/SAT.

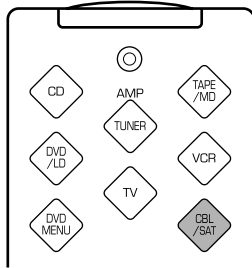

3. Press and hold both VOLUME buttons at least four seconds until the indicator LED flashes twice.
4. Using the keypad, enter the four-digit setup code. The indicator LED will flash twice after your entry. If the LED did not flash twice, repeat steps 3 and 4.
5. To verify the code works, aim the remote control at the cable box (or DSS), press CBL/SAT, and then press POWER. The unit should turn off. If it doesn't respond, use another code for the same manufacturer and repeat steps 3 through 5.

SETTING UP YOUR VCR

1. Turn on the VCR and look up a setup code for your brand of VCR.
2. On the remote control, press VCR.

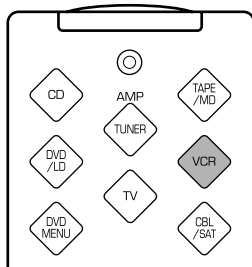

3. Press and hold both VOLUME buttons at least four seconds until the indicator LED flashes twice.
4. Using the keypad, enter the four-digit setup code. The indicator LED will flash twice after your entry. If the LED did not flash twice, repeat steps 3 and 4.
5. To verify the code works, aim the remote control at the VCR, press VCR, and then press POWER. The VCR should turn off. If it doesn't respond, use another code for the same manufacturer and repeat steps 3 through 5.

SETTING UP YOUR DVD (OR LD) PLAYER

1. Turn on the DVD (or LD) player and look up a setup code for your brand of DVD (or LD) player.
2. On the remote control, press DVD/LD.

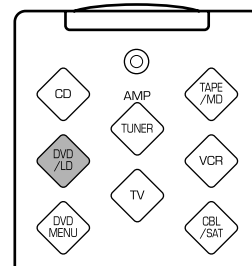

3. Press and hold both VOLUME buttons at least four seconds until the indicator LED flashes twice.
4. Using the keypad, enter the four-digit setup code. The indicator LED will flash twice after your entry. If the LED did not flash twice, repeat steps 3 and 4.
5. To verify the code works, aim the remote control at the DVD (or LD) player, press DVD/LD, and then press POWER. The unit should turn off. If it doesn't respond, use another code for the same manufacturer and repeat steps 3 through 5.

SETTING UP OTHER COMPONENTS

1. Turn on the component (e.g., CD player, tape deck, or MD player) and look up a setup code for your brand of component.
2. On the remote control, press the desired component button (e.g., CD or TAPE/MD).
3. Press and hold both VOLUME buttons at least four seconds until the indicator LED flashes twice.
4. Using the keypad, enter the four-digit setup code. The indicator LED will flash twice after your entry. If the LED did not flash twice, repeat steps 3 and 4.
5. To verify the code works, aim the remote control at the component, press the appropriate component button, and then press POWER. The unit should turn off. If it doesn't respond, use another code for the same manufacturer and repeat steps 3 through 5.

OPERATING THE UNIVERSAL REMOTE CONTROL

OVERVIEW

The universal remote control will control up to seven different types of components (including the HTR-5440 receiver), each of which becomes active when you press a selection (e.g., TV, VCR, etc.). We can only briefly describe some functions here, and we encourage you use the *HTR-5440 Owner's Manual* to gain additional experience with this powerful unit.

PLAYING A VIDEOCASSETTE

1. Aim the remote control at the HTR-5440, press AMP/TUNER to select the component, and then press POWER to turn the receiver on. Press VCR (i.e., 6 on the keypad) as the input for the receiver.
2. Aim the remote control at the TV, press the TV to select the component, and then press POWER to turn the television on. Press TV INPUT (or A/B) to select the correct input.
3. Aim the remote control at the VCR, press VCR to select the component, and then press POWER to turn the VCR on. Put a tape in the VCR, press PLAY.

NOTE: At this point, the VCR controls are assigned to the remote control, since VCR was the last selected component. If you now press the VOLUME up (down) buttons, the TV/VCR volume will be raised (or lowered). To adjust the receiver's volume, you must press AMP/TUNER to activate its functions.

PLAYING A DVD

1. Aim the remote control at the HTR-5440, press AMP/TUNER to select the component, and then press POWER to turn the receiver on. Press DVD (i.e., 4 on the keypad) as the input for the receiver.

NOTE: If the DVD player is connected to an external decoder, press 6CH INPUT (i.e., 9 on the keypad) as the input for the receiver.

2. Press DVD/LD and then press POWER to turn the DVD (or LD) player on.

NOTE: If the DVD player is plugged into the switched ac outlet (on the back of the receiver) and its power switch was already engaged, the unit will come on each time the receiver is powered on.

3. Load a DVD (or LD) into the DVD (or LD) player.
4. Aim the remote control at the DVD (or LD) player, and press > (forward button) to start play.

NOTE: The DVD player's controls are now assigned to the remote control buttons, since DVD was the last selected component.

RESETTING THE REMOTE CONTROL TO FACTORY CODES

You can reset the remote control to factory codes for all components or a desired component, as follows:

RESETTING CODES FOR ALL COMPONENTS

1. Press any component selector button other than AMP/TUNER.
2. Press and hold both VOLUME buttons at least four seconds until the indicator LED flashes twice.
3. Using the keypad, enter the code "9990".
4. The indicator LED will flash twice to confirm all codes have been reset to factory values. If the LED does not flash twice, repeat steps 1 through 3.

RESETTING CODES FOR A DESIRED COMPONENT

1. Press a component selector button that matches the component you wish to reset to factory codes.
2. Press and hold both VOLUME buttons at least four seconds until the indicator LED flashes twice.
3. Using the keypad, enter the code "0000".
4. The indicator LED will flash twice to confirm all codes have been reset to factory values. If the LED does not flash twice, repeat steps 1 through 3.
5. For your convenience, the following reference chart lists the factory codes:

Component Selector Button	Component	Code
TV	TV	0101
CBL/SAT	Cable TV	0006
VCR	VCR	0002
DVD/LD	DVD player	0008 Yamaha
CD	CD player	0005 Yamaha
TAPE/MD	MD recorder	0024 Yamaha