



UAB



# CDC-697

*COMPACT DISC AUTOMATIC CHANGER*



**OWNER'S MANUAL**

# IMPORTANT SAFETY INSTRUCTIONS

	<b>CAUTION</b> RISK OF ELECTRIC SHOCK DO NOT OPEN	
<p>CAUTION: TO REDUCE THE RISK OF ELECTRIC SHOCK, DO NOT REMOVE COVER (OR BACK). NO USER-SERVICEABLE PARTS INSIDE. REFER SERVICING TO QUALIFIED SERVICE PERSONNEL.</p>		

• Explanation of Graphical Symbols



The lightning flash with arrowhead symbol, within an equilateral triangle, is intended to alert you to the presence of uninsulated “dangerous voltage” within the product’s enclosure that may be of sufficient magnitude to constitute a risk of electric shock to persons.



The exclamation point within an equilateral triangle is intended to alert you to the presence of important operating and maintenance (servicing) instructions in the literature accompanying the appliance.

**WARNING**

TO REDUCE THE RISK OF FIRE OR ELECTRIC SHOCK, DO NOT EXPOSE THIS UNIT TO RAIN OR MOISTURE.

**IMPORTANT!**

Please record the serial number of this unit in the space below.

Model:  
Serial No.:

The serial number is located on the rear of the unit. Retain this Owner’s Manual in a safe place for future reference.

**FOR CANADIAN CUSTOMERS**

To prevent electric shock, match wide blade of plug to wide slot and fully insert.  
This Class B digital apparatus complies with Canadian ICES-003.

**POUR LES CONSOMMATEURS CANADIENS**

Pour éviter les chocs électriques, introduire la lame la plus large de la fiche dans la borne correspondante de la prise et pousser jusqu’au fond.  
Cet appareil numérique de la classe B est conforme à la norme NMB-003 du Canada.

- 1 Read these instructions.
- 2 Keep these instructions.
- 3 Heed all warnings.
- 4 Follow all instructions.
- 5 Do not use this apparatus near water.
- 6 Clean only with dry cloth.
- 7 Do not block any ventilation openings. Install in accordance with the manufacturer’s instructions.
- 8 Do not install near any heat sources such as radiators, heat registers, stoves, or other apparatus (including amplifiers) that produce heat.
- 9 Do not defeat the safety purpose of the polarized or grounding-type plug. A polarized plug has two blades with one wider than the other. A grounding type plug has two blades and a third grounding prong. The wide blade or the third prong are provided for your safety. If the provided plug does not fit into your outlet, consult an electrician for replacement of the obsolete outlet.
- 10 Protect the power cord from being walked on or pinched particularly at plugs, convenience receptacles, and the point where they exit from the apparatus.
- 11 Only use attachments/accessories specified by the manufacturer.
- 12 Use only with the cart, stand, tripod, bracket, or table specified by the manufacturer, or sold with the apparatus. When a cart is used, use caution when moving the cart/apparatus combination to avoid injury from tip-over.
- 13 Unplug this apparatus during lightning storms or when unused for long periods of time.
- 14 Refer all servicing to qualified service personnel. Servicing is required when the apparatus has been damaged in any way, such as power-supply cord or plug is damaged, liquid has been spilled or objects have fallen into the apparatus, the apparatus has been exposed to rain or moisture, does not operate normally, or has been dropped.



## FCC INFORMATION (for US customers only)

### 1. IMPORTANT NOTICE: DO NOT MODIFY THIS UNIT!

This product, when installed as indicated in the instructions contained in this manual, meets FCC requirements. Modifications not expressly approved by Yamaha may void your authority, granted by the FCC, to use the product.

### 2. IMPORTANT:

When connecting this product to accessories and/or another product use only high quality shielded cables. Cable/s supplied with this product MUST be used. Follow all installation instructions. Failure to follow instructions could void your FCC authorization to use this product in the USA.

### 3. NOTE:

This product has been tested and found to comply with the requirements listed in FCC Regulations, Part 15 for Class "B" digital devices. Compliance with these requirements provides a reasonable level of assurance that your use of this product in a residential environment will not result in harmful interference with other electronic devices.

This equipment generates/uses radio frequencies and, if not installed and used according to the instructions found in the users manual, may cause interference harmful to the operation of other electronic devices.

Compliance with FCC regulations does not guarantee that interference will not occur in all installations. If this product is found to be the source of interference, which can be determined by turning the unit "OFF" and "ON", please try to eliminate the problem by using one of the following measures:

Relocate either this product or the device that is being affected by the interference.

Utilize power outlets that are on different branch (circuit breaker or fuse) circuits or install AC line filter/s.

In the case of radio or TV interference, relocate/reorient the antenna. If the antenna lead-in is 300 ohm ribbon lead, change the lead-in to coaxial type cable.

If these corrective measures do not produce satisfactory results, please contact the local retailer authorized to distribute this type of product. If you can not locate the appropriate retailer, please contact Yamaha Electronics Corp., U.S.A. 6660 Orangethorpe Ave, Buena Park, CA 90620.

The above statements apply ONLY to those products distributed by Yamaha Corporation of America or its subsidiaries.

## For U.K. customers

If the socket outlets in the home are not suitable for the plug supplied with this appliance, it should be cut off and an appropriate 3 pin plug fitted. For details, refer to the instructions described below.

### Note:

The plug severed from the mains lead must be destroyed, as a plug with bared flexible cord is hazardous if engaged in a live socket outlet.

## SPECIAL INSTRUCTIONS FOR U.K. MODEL

### IMPORTANT:

THE WIRES IN MAINS LEAD ARE COLOURED IN ACCORDANCE WITH THE FOLLOWING CODE:

Blue: NEUTRAL

Brown: LIVE

As the colours of the wires in the mains lead of this apparatus may not correspond with the coloured markings identifying the terminals in your plug, proceed as follows:

The wire which is coloured BLUE must be connected to the terminal which is marked with the letter N or coloured BLACK. The wire which is coloured BROWN must be connected to the terminal which is marked with the letter L or coloured RED. Making sure that neither core is connected to the earth terminal of the three pin plug.

## We Want You Listening For A Lifetime

YAMAHA and the Electronic Industries Association's Consumer Electronics Group want you to get the most out of your equipment by playing it at a safe level. One that lets the sound come through loud and clear without annoying blaring or distortion – and, most importantly, without affecting your sensitive hearing. Since hearing damage from loud sounds is often undetectable until it is too late, YAMAHA and the Electronic Industries Association's Consumer Electronics Group recommend you to avoid prolonged exposure from excessive volume levels.



# CAUTION: READ THIS BEFORE OPERATING YOUR UNIT.

- 1 To assure the finest performance, please read this manual carefully. Keep it in a safe place for future reference.
- 2 Install this sound system in a well ventilated, cool, dry, clean place with at least 10 cm on the top, 10 cm on the left and right, and 10 cm at the back of CDC-697 — away from direct sunlight, heat sources, vibration, dust, moisture, and/or cold.
- 3 Locate this unit away from other electrical appliances, motors, or transformers to avoid humming sounds.
- 4 Do not expose this unit to sudden temperature changes from cold to hot, and do not locate this unit in an environment with high humidity (i.e. a room with a humidifier) to prevent condensation inside this unit, which may cause an electrical shock, fire, damage to this unit, and/or personal injury.
- 5 Avoid installing this unit where foreign object may fall onto this unit and/or this unit may be exposed to liquid dripping or splashing. On the top of this unit, do not place:
  - Other components, as they may cause damage and/or discoloration on the surface of this unit.
  - Burning objects (i.e. candles), as they may cause fire, damage to this unit, and/or personal injury.
  - Containers with liquid in them, as they may fall and liquid may cause electrical shock to the user and/or damage to this unit.
- 6 Do not cover this unit with a newspaper, tablecloth, curtain, etc. in order not to obstruct heat radiation. If the temperature inside this unit rises, it may cause fire, damage to this unit, and/or personal injury.
- 7 Do not plug in this unit to a wall outlet until all connections are complete.
- 8 Do not operate this unit upside-down. It may overheat, possibly causing damage.
- 9 Do not use force on switches, knobs and/or cords.
- 10 When disconnecting the power cable from the wall outlet, grasp the plug; do not pull the cable.
- 11 Do not clean this unit with chemical solvents; this might damage the finish. Use a clean, dry cloth.
- 12 Only voltage specified on this unit must be used. Using this unit with a higher voltage than specified is dangerous and may cause fire, damage to this unit, and/or personal injury. YAMAHA will not be held responsible for any damage resulting from use of this unit with a voltage other than specified.
- 13 Do not attempt to modify or fix this unit. Contact qualified YAMAHA service personnel when any service is needed. The cabinet should never be opened for any reasons.
- 14 When not planning to use this unit for long periods of time (i.e. vacation), disconnect the AC power plug from the wall outlet.
- 15 Be sure to read the “TROUBLESHOOTING” section on common operating errors before concluding that this unit is faulty.
- 16 Before moving this unit, press POWER ON/OFF to release it outward to the OFF position to turn off this unit, and then disconnect the power cable from the AC wall outlet.
- 17 Condensation will form when the surrounding temperature changes suddenly. Disconnect the power cable from the outlet, then leave the unit alone.
- 18 When using the unit for a long time, the unit may become warm. Turn the power off, then leave the unit alone for cooling.
- 19 Install this unit near the wall outlet and where the AC power plug can be reached easily.

- 20 **VOLTAGE SELECTOR (Asia and General models only)**  
The VOLTAGE SELECTOR on the rear panel of this unit must be set for your local main voltage BEFORE plugging into the AC wall outlet. Voltages are 110/120/220/230–240 V AC, 50/60 Hz.
- 21 The batteries shall not be exposed to excessive heat such as sunshine, fire or the like.

## Caution for moving this unit

- When moving this unit, first remove all discs from the disc tray and close the tray by pressing the **OPEN/CLOSE** button, and then switch off the power after you confirm that the front panel display indicates as follows.



Never switch off the power if the front panel display is not pictured as above, otherwise the unit will break down during moving because the internal mechanism is not locked.

This unit is not disconnected from the AC power source as long as it is connected to the wall outlet, even if this unit itself is turned off. This state is called the standby mode. In this state, this unit is designed to consume a very small quantity of power.

## DANGER

When this unit is plugged to the wall outlet, do not place your eyes close to the opening of the disc tray and other openings to look into inside.

## WARNING

TO REDUCE THE RISK OF FIRE OR ELECTRIC SHOCK, DO NOT EXPOSE THIS APPLIANCE TO RAIN OR MOISTURE.

Laser component in this product is capable of emitting radiation exceeding the limit for Class 1.

## Introduction

Thank you for purchasing this YAMAHA product. We hope it will give you many years of trouble-free enjoyment. For the best performance, read this manual carefully. It will guide you in operating your YAMAHA product.

## Features

- 5-Discs Carousel Auto-changer
- Full Opening Disc Tray for Changing 5 Discs at a Time
- PLAYXCHANGE; Disc Changing Capability while Playing back Another
- Repeat, Random and Program Play
- Remote Control Capability

## Contents

### GETTING STARTED

<b>CD PREVENTIVE CARES .....</b>	<b>2</b>
<b>PREPARATIONS .....</b>	<b>3</b>
Supplied Accessories .....	3
Remote Control Transmitter .....	3
Connecting to an Amplifier .....	4
Connecting the AC power cable .....	5
<b>CONTROLS AND FUNCTIONS .....</b>	<b>6</b>
Front Panel .....	6
Remote Control Transmitter .....	7
Display .....	8

### PLAYING CDS

<b>BASIC OPERATION .....</b>	<b>9</b>
Turning On and Off the Power .....	9
Loading and Playing Discs .....	9
PLAYXCHANGE .....	10
Scanning Discs .....	10
Skipping Tracks .....	11
Searching .....	11
CD TEXT .....	11
<b>VARIOUS FUNCTIONS .....</b>	<b>12</b>
Random Sequence Play .....	12
Program Play .....	13
Repeat Play .....	15
Index Search .....	15
Adjusting the Level .....	16
Timer Play .....	16

### FUNCTIONS FOR RECORDING

<b>CD SYNCHRONIZED RECORDING .....</b>	<b>17</b>
<b>TRACK PROGRAMMING FOR RECORDING .....</b>	<b>18</b>
Automatic Tape Programming .....	18
Manual Tape Programming .....	19
Random Tape Programming .....	21
<b>AUTOMATIC PEAK LEVEL SEARCHING ....</b>	<b>22</b>

### ADDITIONAL INFORMATION

<b>TROUBLESHOOTING .....</b>	<b>23</b>
<b>SPECIFICATIONS .....</b>	<b>24</b>

## CD PREVENTIVE CARES

- This compact disc player is designed only for playing back compact discs bearing the marks shown below. Never attempt to load any other type of disc into the unit. The unit can also play back 8 cm (3 inch) compact discs.



### Notes

- This unit may not be able to play back some CD-R/CD-RW discs or discs on which recording was not made correctly.
- This unit is not compatible with a CD-R/CD-RW disc recorded with MP3 or WMA format.
- Compact discs are not subjected to wear during playback, but damage to the disc surface when the disc is being handled can adversely affect the disc playback.
- Do not use cleaning discs or warped discs. All of these could damage the unit.

### To prevent a malfunction of this unit

- Do not use any non standard shaped CD (heart, etc.) available on the market, because it may damage the unit.

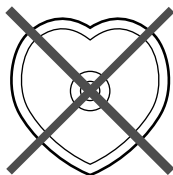

- Do not use a CD with tape, seals, or paste on it, because damage to the unit may result.

- Compact discs are not affected by small particles of dust or fingerprints on their playing surface, but even so they should be kept clean. Wipe by using a clean, dry cloth. Do not wipe with a circular motion; wipe straight outward from the center.

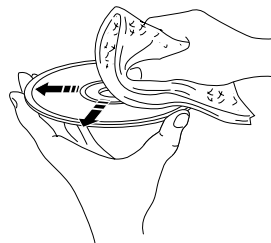

- Do not try to clean the disc's surface by using any type of disc cleaner, record spray, anti-static spray or liquid, or any other chemical-based liquid, because such substances might irreparably damage the disc's surface.
- Do not expose discs to direct sunlight, high temperature or high humidity for a long period of time, because these might warp or otherwise damage the disc.



# PREPARATIONS

## Supplied Accessories

Remote Control Transmitter

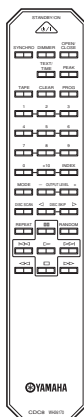

Batteries (AA, R6, UM-3) x 2

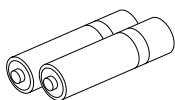

Audio Pin Cable

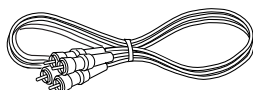

Power cable  
(U.S.A., Canada, Australia, U.K. and Europe models) The shape of the plug may vary depending on the area where you purchased.

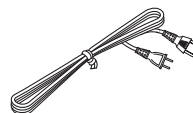

## Remote Control Transmitter

### ■ Battery installation

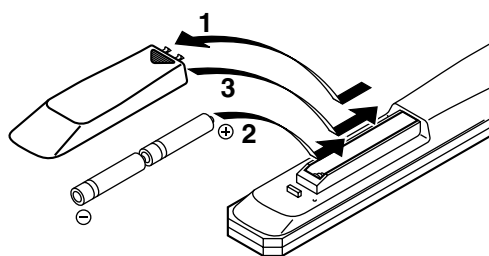

### ■ Battery replacement

If you find that the remote control transmitter must be used closer to the main unit, the batteries are weak. Replace both batteries with new ones.

#### Notes

- Use only AA, R6, UM-3 batteries for replacement.
- Be sure the polarities are correct. (See the illustration inside the battery compartment.)
- Remove the batteries if the remote control transmitter will not be used for an extended period of time.
- If batteries leak, dispose of them immediately. Avoid touching the leaked material or letting it come in contact with clothing, etc. Clean the battery compartment thoroughly before installing new batteries.

### ■ Remote control transmitter operation range

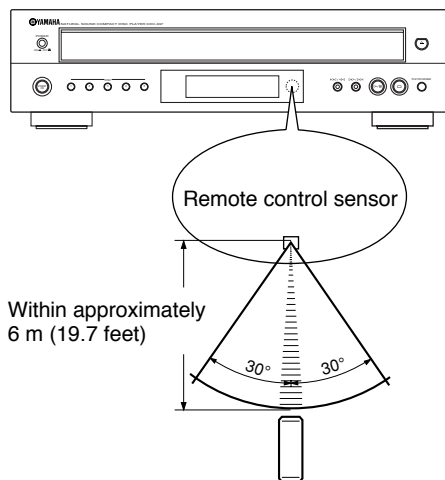

#### Notes

- There should be no large obstacles between the remote control transmitter and the main unit.
- If the remote control sensor is directly illuminated by strong lighting (especially an inverter type of fluorescent lamp, etc.), it might cause the remote control transmitter not to work correctly. In this case, reposition the main unit to avoid direct lighting.

## Connecting an Amplifier

Never plug in this unit and other components until all connections are completed.

- Before making any connections, switch OFF the power to the unit and the amplifier or other components.
- Connections should be made to the correct input terminals of the amplifier or other components.
- If the placement of this unit causes noise in other equipment, such as a tuner, separate them from each other.

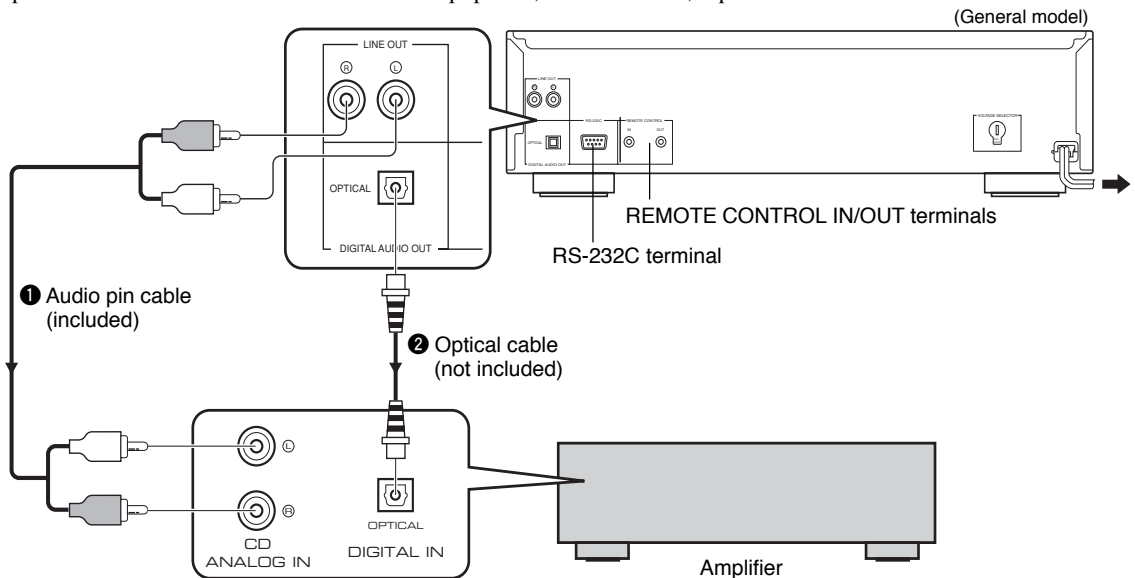

Choose one of the ways listed below to connect this unit to your amplifier.

### ■ When the LINE OUT (analog) terminals of this unit are used (①)

- Be sure that the left (L) and right (R) LINE OUT terminals are connected to the corresponding (left and right) terminals of the amplifier or other components.
- Connect the LINE OUT terminals to the CD (or AUX) terminals of the amplifier. For additional details concerning these connections, refer to the operation instructions for the amplifier being used.

### ■ When the DIGITAL AUDIO OUT (OPTICAL) terminal of this unit is used (②)

- Before using this terminal, remove the terminal cover by pulling it.
- Make the connection from this terminal to the optical input terminal of an amplifier by using a commercially available optical cable.
  - \* Be sure to use a high quality optical fiber cable. Other cables might not function correctly.
- Be sure to attach the terminal cover when this terminal is not being used in order to protect the terminal from dust.
- Set the level of signals output into an amplifier to max by using the **OUTPUT LEVEL**  $-/+$  buttons.

#### For Custom Installer

##### ■ REMOTE CONTROL IN/OUT terminals

These terminals are used for custom installation system. When this unit is connected to the components for custom installation system, you can operate this unit with the system remote control.

Connect the **REMOTE CONTROL IN** terminal of this unit to the output terminal of the central controller for custom installation system.

By connecting the **REMOTE CONTROL OUT** terminal of this unit to the **REMOTE CONTROL IN** terminal of the other component, you can also operate it with the system remote control. In this way, up to 6 components can be connected in series.

##### ■ RS-232C terminal

This terminal does not support normal external component connection. This is an expansion terminal for factory use only.



## Connecting the power cable

After all other connections are completed, plug the power cable to an AC wall outlet.

- China, Asia and General models

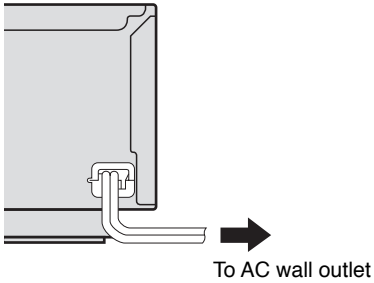

- Other models

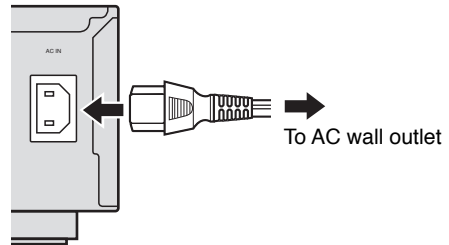

Plug the power cable into the AC IN, then plug the power cable to an AC wall outlet.

### ■ VOLTAGE SELECTOR (Asia and General models only)

The VOLTAGE SELECTOR on the rear panel of this unit must be set for your local main voltage BEFORE plugging into the AC main supply. Voltages are AC 110/120/220/230–240 V, 50/60 Hz.

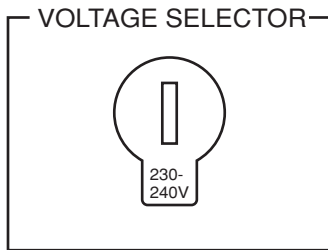

# CONTROLS AND FUNCTIONS

## Front Panel

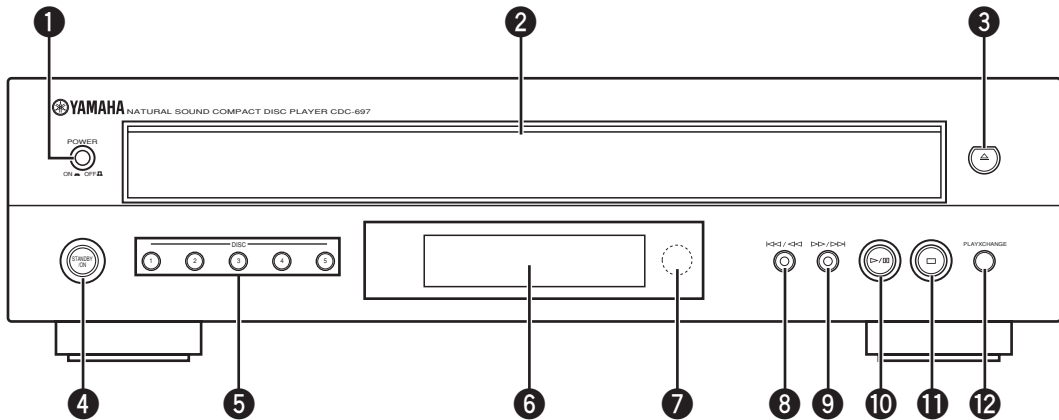

- |                               |      |                                      |      |
|-------------------------------|------|--------------------------------------|------|
| <b>1</b> POWER .....          | P.9  | <b>7</b> Remote control sensor ..... | P.3  |
| <b>2</b> Disc tray .....      | P.9  | <b>8</b> ⏮/⏪ (Skip/Search) .....     | P.11 |
| <b>3</b> △ (Open/Close) ..... | P.9  | <b>9</b> ⏩/⏭ (Skip/Search) .....     | P.11 |
| <b>4</b> STANDBY/ON .....     | P.9  | <b>10</b> ▷/⏸ (Play/Pause) .....     | P.10 |
| <b>5</b> DISC-select .....    | P.10 | <b>11</b> □ (Stop) .....             | P.10 |
| <b>6</b> Display panel .....  | P.8  | <b>12</b> PLAYXCHANGE .....          | P.10 |

# Remote Control Transmitter

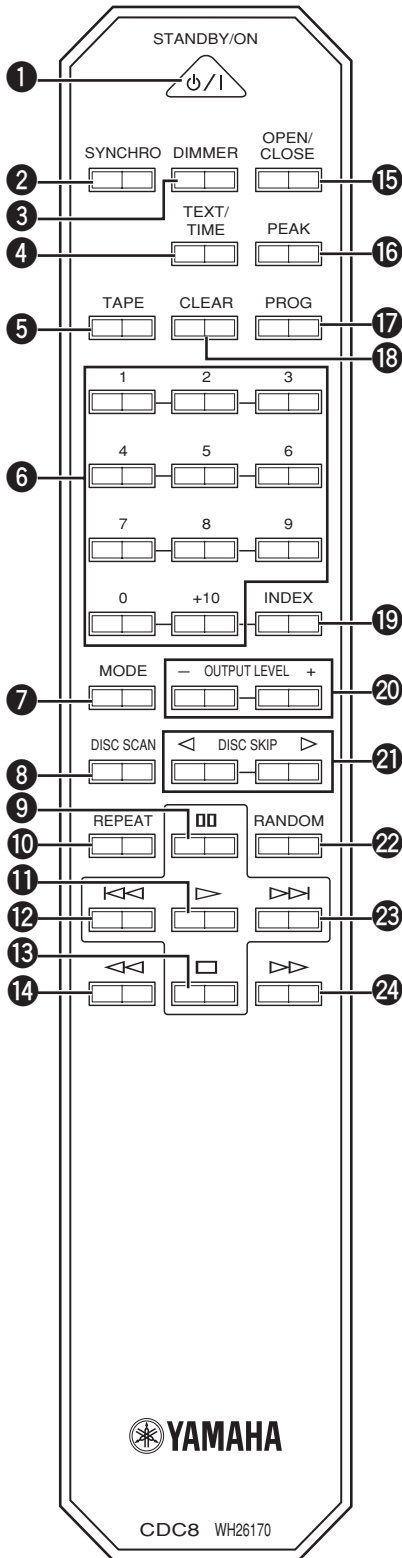

- 1** STANDBY/ON ..... P.9
- 2** SYNCHRO ..... P.17
- 3** DIMMER ..... P.8
- 4** TEXT/TIME ..... P.8
- 5** TAPE ..... P.18
- 6** Numeric buttons ..... P.11
- 7** Disc play **MODE**-select ..... P.9
- 8** DISC SCAN ..... P.10
- 9** (Pause) ..... P.10
- 10** REPEAT ..... P.15
- 11** (Play) ..... P.10
- 12** (Skip) ..... P.11
- 13** (Stop) ..... P.10
- 14** (Search) ..... P.11
- 15** OPEN/CLOSE ..... P.9
- 16** PEAK ..... P.22
- 17** PROG ..... P.13
- 18** CLEAR ..... P.14
- 19** INDEX ..... P.15
- 20** OUTPUT LEVEL +/- ..... P.16
- 21** DISC SKIP ..... P.10
- 22** RANDOM ..... P.12
- 23** (Skip) ..... P.11
- 24** (Search) ..... P.11

# Display

The display located in the center of this unit provides information about discs.

After closing the disc tray by pressing the **OPEN/CLOSE** button or selecting any disc by using the **DISC SKIP** buttons when this unit is stopped, the display shows the total number of tracks and the total recorded time of the selected disc for a few seconds.



## ■ Display information at disc playback

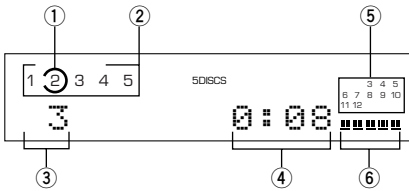

- ① Encloses the tray number of the selected disc.
- ② The numbers corresponding to trays that contain discs light up after discs are selected.
- ③ Shows the selected track number.
- ④ Shows the time displays. (For details, refer to “Selecting time displays and the text data” on the right column.)
- ⑤ Displays the numbers that correspond to the numbers of the tracks (as high as number 20) on the selected disc. After each track is played back, its corresponding number disappears so the number of remaining tracks (and their numbers) can be seen at a glance.
- ⑥ Shows the level of signals output into an amplifier adjusted by using the **OUTPUT LEVEL**  $-/+$  buttons.

## ■ Changing brightness of the display

If desired, you can change brightness of the display in three degrees by pressing the **DIMMER** button.



## ■ Selecting time displays and the text data

You can select any of the four time displays by pressing the **TEXT/TIME** display mode-select button. Since this unit is CD TEXT compatible, the disc title, artist name, and track name are also displayed in addition to the time displays when playing back a CD with CD TEXT. Each time you press the **TEXT/TIME** display mode-select button, the display changes as follows.

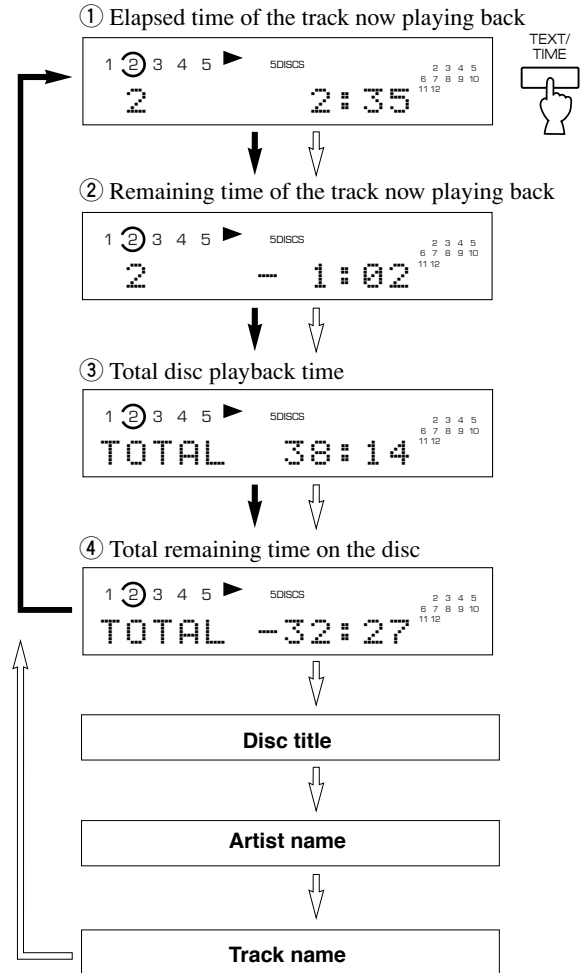

- ➡ when playing back a disc without CD TEXT
- ⇨ when playing back a CD TEXT disc

### Notes

- The remaining time ② will not be displayed if the track number is 21 or higher.
- The disc title, artist names, or track names may not be displayed with some CD TEXT discs. In this case, “NO ENTRY” appears in the display.

# BASIC OPERATION

This manual describes how to operate this unit by using the remote control transmitter.

To operate this unit on the front panel, use the corresponding buttons on the front panel.

## Loading and Playing Discs

### Turning On and Off the Power

#### POWER

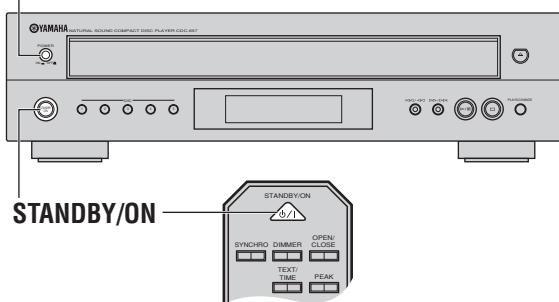

#### ■ To turn on this unit

Press the **POWER** button inward to the **ON** position.



On the front panel

- Press the **STANDBY/ON** button to set this unit to the standby mode.



On the remote control transmitter



On the front panel

- Press the **STANDBY/ON** button to turn on this unit.



On the remote control transmitter



On the front panel

#### Note

You can operate this unit only when the **POWER** button is pressed inward to the **ON** position.

#### ■ To turn off this unit

Press the **POWER** button again to release it outward to the **OFF** position.



On the front panel

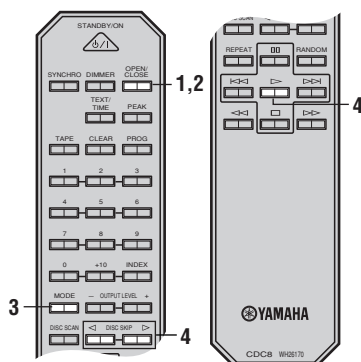

PLAYING CDS

#### 1 Open the disc tray and load discs.

Use the disc guides to align the discs correctly in the tray.

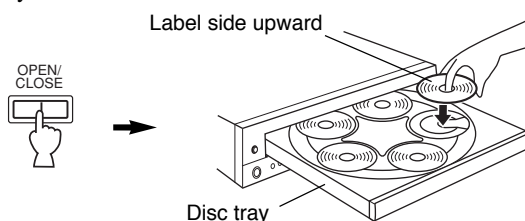

To play back an 8 cm (3 inch) CD, place it in the inner recessed area of the disc tray. Do not put a normal (12 cm (5 inch)) CD on top of an 8 cm CD.

#### 2 Close the disc tray.



- You can also close the disc tray by pressing the  $\triangleright/\square$  button on the front panel, a **DISC-SELECT** button on the front panel, a numeric button or the **RANDOM** button, or by pressing the front edge of the disc tray gently. If the tray is closed in these ways, playback will start automatically, however, the display will not show the total number of tracks and the total recorded time of the first selected disc.

**3 Select a desired disc play mode (1DISC or 5DISCS) confirming it on the display.**

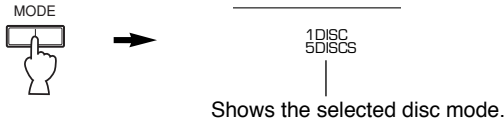

- “1DISC” mode: The unit will play back a designated disc only.
- “5DISCS” mode: The unit will play back all discs on the tray in sequence.

**4 Start playback from the first track of the disc 1.**



\* If necessary, select a desired disc by using the **DISC SKIP** buttons, or a **DISC-select** button on the front panel.

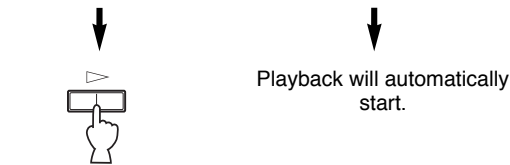
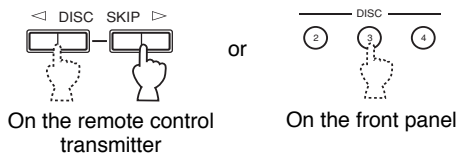

**■ To stop playback temporarily**

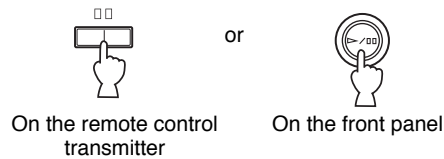

To resume playback, press the **⏏** button again (or press the **▶** button).

\* The **▶/⏏** button on the front panel can also be used to stop playback temporarily or to resume playback.

**■ To stop playback completely**

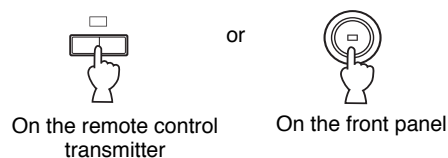

**PLAYXCHANGE**

During playback, you can open the disc tray by pressing the **PLAYXCHANGE** button on the front panel without interrupting disc playback. However, in this case, pressing the **DISC SKIP** buttons has no effect. You can load or replace discs on the trays when the disc tray is opening, however, never load a disc on the tray hidden inside the unit. If doing so, the disc and the unit may be damaged, because the tray already has a disc, which is being played back.

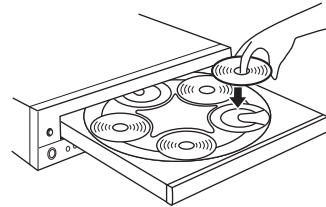

**Scanning Discs**

**■ This mode is convenient to search for a desired disc (or to check discs on the disc tray)**

When the **DISC SCAN** button is pressed in stop mode, this unit will play back a section of each disc in turn for 8 seconds.

If, during this playback, you find a disc that you want to listen to, press the **DISC SCAN** button once again or press the **▶** button to cancel this function. The unit will enter into the normal playback mode.



**Notes**

- During this playback, the disc tray numbers blink in the display. Every time the playback of a disc is finished, the corresponding tray number is changed from flashing to lighting.
- If the disc being played back has a long blank space between tracks, you will hear no sound during disc scan.

## Skipping Tracks

- To play back from the beginning of the track following the one now playing back



- To play back from the beginning of the track now playing back



- To play back from the beginning of the track before the one now playing back

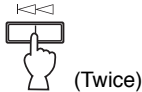

- These operations can also be performed when the unit is paused or stopped.
- When using the <<< or >>> button on the remote control transmitter:
  - \* If the button is pressed and held, the track number is continuously changed to higher numbers (or lower numbers).

## ■ DIRECT PLAY

Select a desired track by using the numeric buttons.

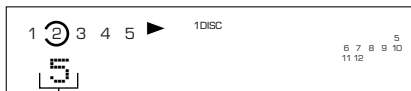
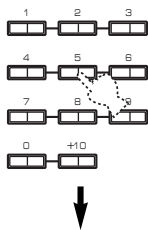

The selected track number is displayed.

### Example: To select track 25

Press +10 twice, then immediately press 5 once.

- \* If a track number higher than the highest track number on the disc is selected, the last track on the disc will be played back.

## Searching

- To go forward rapidly

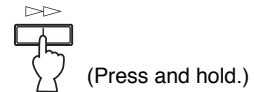

- To go backward rapidly

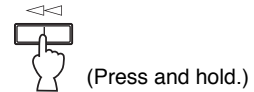

- The sound can be heard (although slightly garbled) during manual search in either direction. This is convenient for locating a precise position within a track, or for reviewing the contents quickly.
- Manual search can also be performed while disc playback is paused. In this case, no sound will be heard.

## CD TEXT

This unit is compatible with the CD TEXT function. The CD TEXT disc has information, such as the disc title, artist names, and track names. If the current disc is a CD TEXT disc, the unit reads the disc title, artist name, and track names from the disc. You can display the CD TEXT data (see "Selecting time displays and the text data" on page 8).

# VARIOUS FUNCTIONS

## Random Sequence Play

You can play back the tracks on one or more discs in a random sequence. The unit will automatically mix up tracks from all discs or a designated disc on the disc tray.

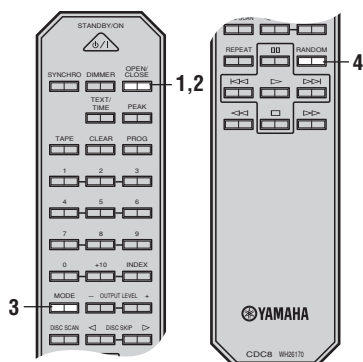

### 1 Load one or more discs.

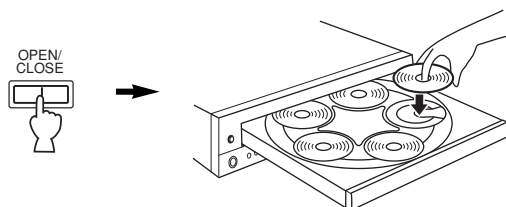

### 2 Close the disc tray.



### 3 Select a desired disc play mode (1DISC or 5DISCS).



- \* If you select "1DISC" mode, next select a desired disc by using the **DISC SKIP** buttons on the remote control transmitter or a **DISC-select** button on the front panel.

### 4 Press the RANDOM button.





"RNDM" lights up in the display.

### To cancel random-sequence play

Press the  button or **RANDOM** button once again, or open the disc tray by pressing the **OPEN/CLOSE** button. "RNDM" disappears from the display.

#### Notes

- This feature will not function during programming, or during program play.
- If the  button is pressed during random-sequence play, the next randomly programmed track will be played back. If the  button is pressed, playback will return to the beginning of the track now being played back.
- This indication appears while the unit is mixing up tracks.

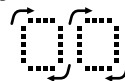

- Total remaining time on the disc will not be displayed during random-sequence play.



# Program Play

You can enjoy listening to your favorite tracks selected from one or more discs in any desired order by programming tracks.

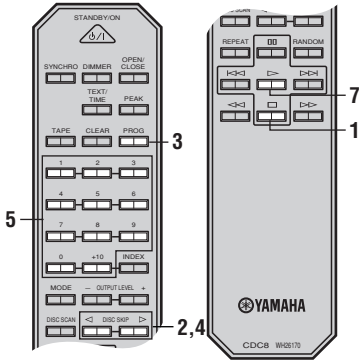

**4** If necessary, select a desired disc.

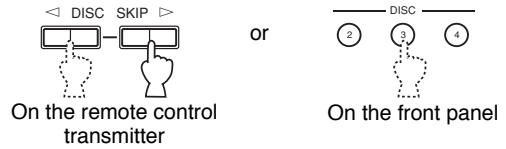

**5** Program a desired track by pressing the corresponding numeric button.

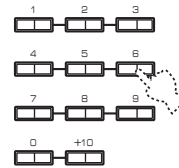

**6** Repeat steps 4 and 5 to program more tracks. You can select the same track again.

**7** When the programming is completed, start the playback.



**1** Stop the unit.



**2** If you will select tracks from a disc (or discs) other than the disc on the Disc 1 tray, make this unit display the total recorded time of each disc to be used by pressing the DISC SKIP buttons in turn.

\* Without this operation, the total time of the programmed tracks will not be displayed during programming.

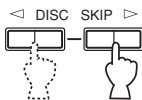

**3** Press the PROG button to start programming.

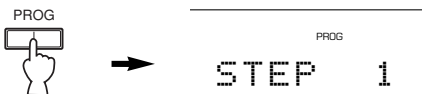

## ■ Display information during programming

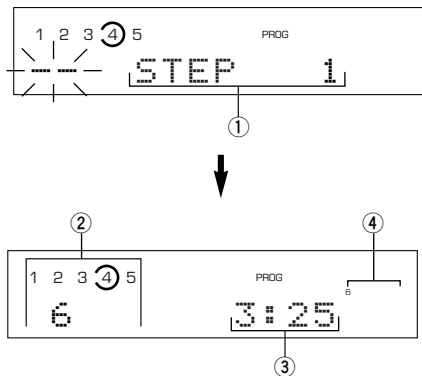

- ① Shows the program number for the track to be programmed next.
- ② Shows the selected disc and track number.
- ③ Shows the total time of the tracks currently programmed.
- ④ Shows only the numbers of programmed tracks on the selected disc.

- \* If "STEP 1" does not appear on the display after the **PROG** button is pressed, press the **TEXT/TIME** display mode-select button.
- \* If the total time exceeds 99 minutes and 59 seconds, the time will not be displayed.

### Notes

- You can program as many as 40 tracks at one time.
- You can program a whole disc by pressing "0", instead of one track. At that time, "ALL" lights up in the display.
- The total time of the programmed tracks will not be displayed, if a track number higher than 20 is programmed.
- If, during programming, the **TEXT/TIME** display mode-select button is pressed, the program number display can be changed to display the total time of the programmed tracks or no information. To return to the previous display, press the **TEXT/TIME** display mode-select button once again.
- The <<< and >>> buttons can be used during playback, but only within the range of the programmed tracks.
- Pressing a numeric button stops the current program and skips to the beginning of the track of the number pressed. Once that track has finished playback, the previously interrupted program resumes playback.
- The <<< and >>> buttons can be used during playback to search all tracks, including unprogrammed tracks.

## ■ To stop program play

Press the □ button. The first programmed track number will be displayed.

To resume playback, press the ▷ button. Playback will start from the beginning of the program.

## ■ To cancel a programmed sequence

There are several methods, as described below.

- Press the □ button or the **CLEAR** button while the unit is stopped.
- Open the disc tray.
- Press the **STANDBY/ON** button.
- Switch off the power.

## ■ To check program data

- 1 During program play, press the □ button.
- 2 Press the **PROG** button.
- 3 Each time the ▷> button is pressed, the track numbers and sequential order of the programmed tracks can be checked one after another. The display of the track number can be returned (sequentially in reverse order) by pressing the <<< button.

## ■ To correct program data

- 1 Follow the procedure described in "To check program data".
- 2 Display the track number to be corrected by pressing the <<< or >>> button.
- 3 Press a numeric button to select a track to replace the one displayed. The previously programmed track will be cleared from the memory and the new one will be programmed.
- 4 After the correction has been completed, press the **PROG** button or ▷ button once again.

## Repeat Play

You can play back any desired track or disc (or a set of discs) repeatedly by pressing the **REPEAT** button. The repeat play mode will change whenever you press the **REPEAT** button.

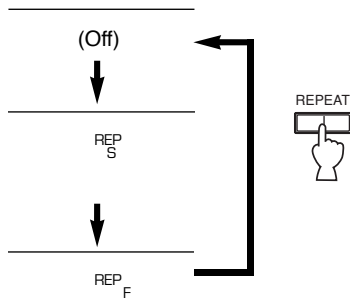

### ■ REP S (Single repeat)

A single track is repeatedly played back.

\* This is also available in the program play mode and the random-sequence play mode. (If the repeat play mode is switched off, the program play mode or the random-sequence play mode will be resumed.)

### ■ REP F (Full repeat)

In the “1DISC” disc play mode: A designated disc is repeatedly played back.

In the “5DISCS” disc play mode: All discs on the disc tray are repeatedly played back.

\* In the program play mode, all programmed tracks are repeatedly played back.

\* In the random-sequence play mode, all randomly sequenced tracks on a designated disc (1DISC) in the same order, or all randomly sequenced discs and tracks (5DISCS) are repeatedly played back.

## Index Search

If the disc includes index numbers, playback can be started from any desired index number.

### 1 Select a track which has index numbers.

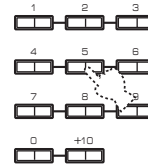

### 2 Press the INDEX button.

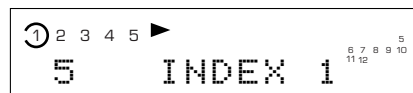

### 3 Select the desired index number.

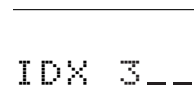

### ■ To cancel the index search function

Press the **INDEX** button.

#### Notes

- Not all discs have index numbers. The index system has a method for sub-dividing tracks into smaller divisions (for example, the movements within classical symphonies) for easier location of those parts. The liner notes with the disc usually tell if such index numbers are included.
- If an index number is selected that is higher than any index number on that disc, playback will start from the last index number point on the disc.
- For some discs, playback may start slightly prior to the actual designated index point.
- If the disc has no encoded index points, playback will start from the beginning of the selected track.

## Adjusting the Level

### ■ Adjusting the level of signals output into an amplifier, etc.

You can adjust the level of sound signals output from the **LINE OUT** terminals on the rear panel into an amplifier, etc.

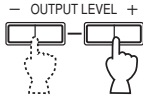

#### For optimum sound quality

- \* When the **DIGITAL AUDIO OUT (OPTICAL)** terminal is used for the connection, set the level of output signals to max.
- \* The level of output signals can be checked in the display.

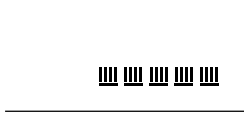

## Timer Play

You can start playback at any specified time by connecting a timer (sold separately). (For details, refer to the owner's manual of the timer.)

- 1** Select the desired play mode (1DISC or 5DISCS).
- 2** Press the **POWER** button to turn the unit off.
- 3** Press the **POWER** button while pressing the  $\triangleright/\square$  button on the front panel.

Shortly thereafter, "TIMER P. ON" appears in the display and the timer play function is on.

(When the timer play function is already on, in which case, "TIMER P. OFF" appears in the display and timer play function is off. In this case, repeat the procedure in steps 2 and 3 to set the timer play function to on.)

- 4** Set the timer to the desired time.  
When the set time comes, the unit turns on and starts playback.

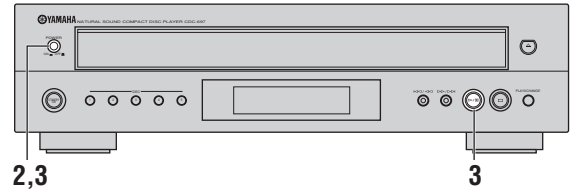

# CD SYNCHRONIZED RECORDING

Using a compatible YAMAHA tape deck, you can synchronize the tape deck to start recording automatically when this unit starts playback. With this function, you can record a CD on tape more easily and precisely. (For details, refer to the operation manual of the tape deck to know whether it is compatible or not.)

\* This unit and the tape deck must be placed close to each other so that both of them can receive the signals from the remote control transmitter of this unit at the same time.

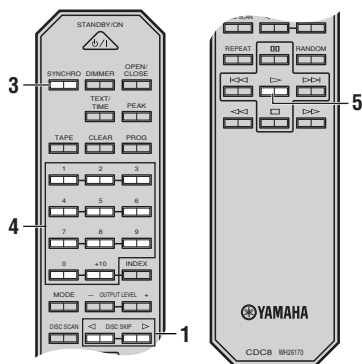

## 1 Select a disc.

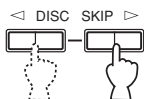

## 2 Load a tape on the tape deck.

\* The peak level searching function of this unit is useful for adjusting recording level on the tape deck. (For details, refer to page 22.)

## 3 Press the SYNCHRO button.



This unit enters into the pause mode, and the tape deck enters into the REC/PAUSE mode.

\* In this mode, the time display on this unit blinks.

## 4 If desired, select the track to be recorded first.

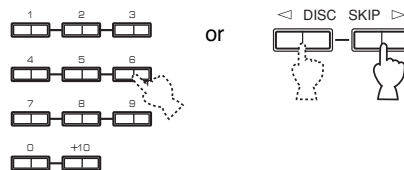

## 5 Press the > button.



Both CD playback and tape deck recording start.

\* CD playback starts a little later than recording.

## 6 If you want to stop recording temporarily and restart recording from a desired track, follow steps 3 to 5 again.

## To cancel this function

Press the □ button.

### Notes

- To finish or stop recording, press the □ button on the tape deck.
- Programmed sequence of tracks can also be recorded with this function, instead of recording an entire disc. (For details, refer to pages 13 to 14.)
- This function can also be used together with the tape-programming function. (For details, refer to pages 18 to 21.)

# TRACK PROGRAMMING FOR RECORDING

This convenient feature can be used to program tracks for recording to tape. By only memorizing the total possible recording time of the tape, the unit will automatically program tracks or help you to program tracks so they will fit onto the tape with the least amount of unrecorded space remaining at each end of the tape.

The peak level searching function of this unit is useful for adjusting recording level on the tape deck. (For details, refer to page 22.)

## Automatic Tape Programming

The unit will automatically program tracks on a disc with the original order of tracks unchanged.

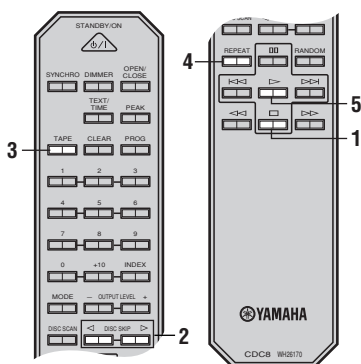

**1** Stop the unit.



**2** Select the disc.

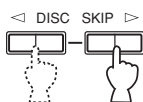

**3** Enter the total possible recording time of the tape (tape length).

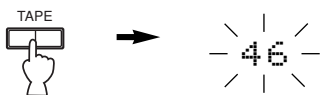

You can select any of four tape lengths by pressing the **TAPE** button.

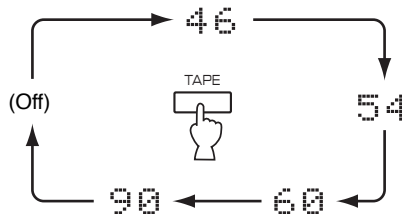

You can also enter the total possible recording time of the tape manually.

**Example:** For a C-64 tape (32 minutes on each side)

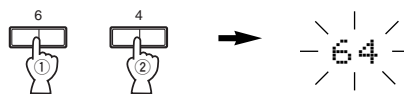

**4** Press the **REPEAT** button.



The unit automatically programs tracks for side A and side B separately considering the total time of the tape.

\* The programmed track numbers and the total number of tracks for side A and B are displayed for a short time.

**5** Start recording on the tape deck and press the **>** button at the same time.

**6** The unit will pause at the end of side A of the tape.

Turn the tape over to side B. Resume recording and, at the same time, press the **>** or **□** button.

### Notes

- It is recommended that you use a tape that is slightly longer in length than the CD you are recording, because the programmed tracks on a CD may not fit properly into the time allowed on each half of the tape.
- CD synchronized recording function can be used if your tape deck is compatible with it. In this case, in step 5 and 6, press the **SYNCHRO** button and then press the **>** button. Recording automatically starts. (For details, refer to page 17.)

## ■ Display information during programming

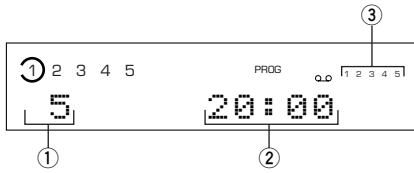

- ① Shows the number of programmed tracks for each side in turn just after the automatic programming is finished, and then it is replaced by the number of the first programmed track for side A.
- ② Shows the total time of programmed tracks for each side.
- ③ Shows the programmed track numbers for each side.

## Manual Tape Programming

With this function, you can program tracks from one or more discs in any order to be recorded onto tape.

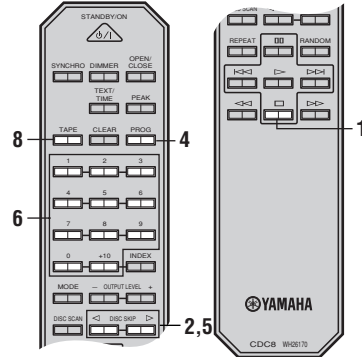

### 1 Stop the unit.



### 2 If you will select tracks from a disc (or discs) other than the disc on the Disc 1 tray, make this unit display the total recorded time of each disc to be used by pressing the DISC SKIP buttons in turn.

\* This unit will read the contents of a disc by this operation. If there is a disc to which this operation is omitted, tracks on the disc cannot be programmed.

### 3 Follow step 3 on page 18.

### 4 Press the PROG button.



### 5 If necessary, select a desired disc by pressing the DISC SKIP buttons.

### 6 Select a desired track.

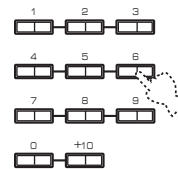

**7 Repeat steps 5 and 6 to program more tracks for side A of the tape.**

You can select the same track again.

- \* If “ERROR” appears in the display, the track number just selected cannot be programmed because there is no enough time remaining on side A of the tape.

**8 When you finish the programming for side A, program the pause mode by pressing the TAPE button.**



- \* “PAUSE” lights up in the display.

**9 Repeat steps 5 and 6 to program more tracks for side B of the tape.**

You can select the same track again.

- \* If “ERROR” appears in the display, the track number just selected cannot be programmed because there is no enough time remaining on side B of the tape.

**10 Start recording on the tape deck and press the ▷ button at the same time.**

**11 The unit will pause at the end of side A of the tape. Turn the tape over to side B. Resume recording and, at the same time, press the ▷ button.**

**Notes**

- In steps 7 and 9, even if “ERROR” appears in the display, you can program another track of which time is shorter than the remaining time on the side of the tape. At this time, if any other track number lights up in the display, you can program it.
- CD synchronized recording function can be used if your tape deck is compatible with it.  
In this case, in steps 10 and 11, press the **SYNCHRO** button and then press the ▷ button. Recording automatically starts. (For details, refer to page 17.)

**Notes on tape programming**

- You can check, cancel or correct program data. (For details, refer to page 14.)
- The maximum number of tracks that can be programmed is 40. If, however, the PAUSE mode is inserted, it is counted as one track.
- This function can be used to program up to track number 20. If the disc has more than 20 tracks, tracks with track number 21 and higher cannot be programmed.

**Display information during programming**

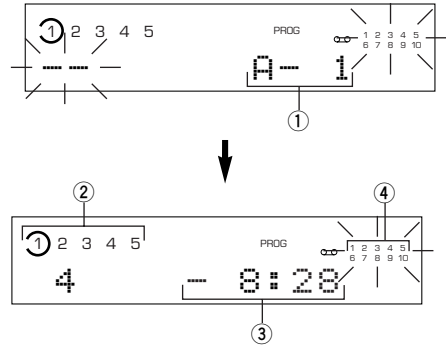

- ① Shows the side of the tape and the program number for the track to be programmed next.
- ② Shows the selected disc and track number.
- ③ Shows the total remaining time on the side of the tape.
- ④ Programmed track numbers light up and programmable track numbers among the unprogrammed ones blink.

- \* If “A-1” does not appear in the display after the **PROG** button is pressed, press the **TEXT/TIME** display mode-select button.
- \* If, during programming, the **TEXT/TIME** display mode-select button is pressed, the program number display can be changed to display the total remaining time on the side of the tape. To return to the previous display, press the **TEXT/TIME** display mode-select button once again.



## Random Tape Programming

The unit will automatically program tracks on a disc in random sequential order for recording to tape.

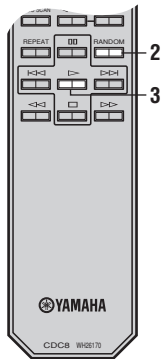

**1** Follow steps 1 to 3 on page 18.

**2** Press the **RANDOM** button.



The unit will automatically program tracks for side A and side B separately considering the total time of the tape.

\* The programmed track numbers and the total number of tracks for side A and B are displayed for a short time.

**3** Start recording on the tape deck and press the **▷** button at the same time.

**4** The unit will pause at the end of side A of the tape.

Turn the tape over to side B. Resume recording and, at the same time, press the **▷** or **□□** button.

### Notes

- Because the programmed data changes every time the **RANDOM** button is pressed, the amount of time remaining at the end of the tape also changes accordingly.
- It is recommended that you use a tape that is slightly longer in length than the CD you are recording, because the programmed tracks on a CD may not fit properly into the time allowed on each half of the tape.
- CD synchronized recording function can be used if your tape deck is compatible with it.  
In this case, in steps 3 and 4, press the **SYNCHRO** button and then press the **▷** button. Recording automatically starts. (For details, refer to page 17.)

### Display information during programming

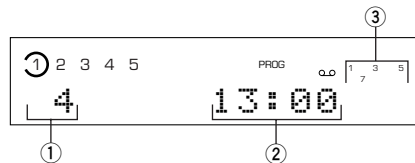

- ① Shows the number of programmed tracks for each side in turn just after the automatic programming is finished, and then it is replaced by the number of the first programmed track for side A.
- ② Shows the total time of programmed tracks for each side.
- ③ Shows the programmed track numbers for each side.

# AUTOMATIC PEAK LEVEL SEARCHING

This unit automatically searches for the peak level of the disc, and play back the part repeatedly. When recording to tape, this feature is very helpful for adjusting the recording level on the tape deck.

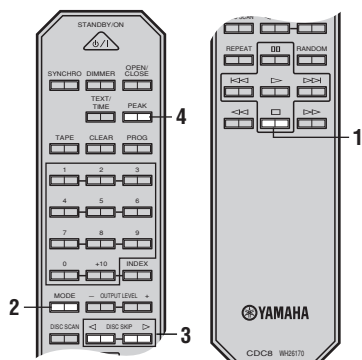

## 1 Stop the unit.



## 2 Select the "1DISC" disc play mode.



## 3 Select the disc.

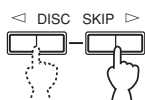

## 4 Press the PEAK button.

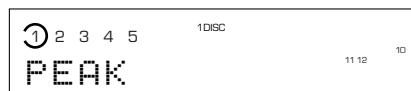

The peak level search is performed on the disc.

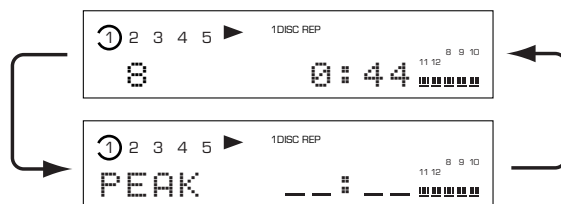

After searching, this unit plays back the part around the peak level.

According to the peak level, adjust the recording level on your tape deck. (For details, refer to the owner's manual of the tape deck.)

## To cancel this function

Press the button.

### Notes

- Even if the peak level search is performed twice or more on the same disc, the same part will not be always selected, because this unit will search for the peak level among parts on the disc that are randomly selected by the internal microcomputer.
- In the program play mode, this feature will function among the programmed tracks only. If program play is being performed, first press the button, and then press the **PEAK** button. If program play is not being performed, only press the **PEAK** button.
- To search for the peak level through all discs on the disc tray, in step 2, select the "5DISCS" disc play mode.

# TROUBLESHOOTING

If the unit fails to operate normally, check the following points to determine whether the problem can be corrected by the simple measures suggested. If it cannot, or if the problem is not listed in the SYMPTOM column, disconnect the unit's power cord and contact your authorized YAMAHA dealer or service center for help.

SYMPTOM	PROBABLE CAUSE	REMEDY
<b>This unit fails to turn on or enters the standby mode soon after the power is turned on.</b>	The power cord is not connected or not completely connected.	Securely connect the power cord.
<b>This unit does not work normally.</b>	There is an influence of strong external noise (lightning, excessive static electricity, etc.) or an incorrect operation was performed while using this unit.	Turn off and disconnect the AC power from the AC wall outlet. After about 30 seconds, connect the power and try again.
<b>The disc tray does not close completely.</b>	A foreign object is obstructing the tray.	Carefully check the disc tray and remove the foreign object.
<b>A disc number does not light up on the display.</b>	The disc has been loaded upside down.	Reload the disc with the label side up.
	The disc is damaged.	Check the disc carefully; replace it if necessary.
	There is moisture on the laser pickup.	Wait 20 to 30 minutes after switching the unit ON before trying to play back a disc.
<b>Playback does not start.</b>	The disc is damaged.	Check the disc carefully; replace it if necessary.
	The disc has been loaded upside down.	Reload the disc with the label side up.
	The disc is dirty.	Clean the disc.
<b>Playback is delayed, or starts at the wrong place.</b>	The disc may be scratched or damaged.	Check the disc carefully; replace it if necessary.
<b>No sound.</b>	Improper output cable connections.	Connect the cables properly. If the problem persists, the cables may be defective.
	Improper amplifier operation.	Set the amplifier controls to the correct input selection.
<b>Sound "skips".</b>	This unit is being subjected to vibrations or impacts.	Relocate this unit.
	The disc is dirty.	Clean the disc.
<b>Sound "hums".</b>	Improper cable connections.	Securely connect the audio cables. If the problem persists, the cables may be defective.
<b>Noise from a nearby tuner.</b>	The tuner is too close to this unit.	Move the tuner and this unit farther apart.
<b>Noise from inside of the disc tray.</b>	The disc may be warped.	Replace the disc.
<b>The remote control transmitter does not work.</b>	The batteries of this remote control transmitter are too weak.	Replace the batteries with new ones.
	Direct sunlight or lighting (of an inverter type of fluorescent lamp, etc.) is striking the remote control sensor of the main unit.	Change position of the main unit.

# SPECIFICATIONS

## Audio Section

Frequency response .....	10 Hz – 20 kHz, $\pm 0.5$ dB
Harmonic distortion + noise (1 kHz) .....	0.003%
S/N ratio .....	106 dB
Dynamic range .....	96 dB
Output level (1 kHz, 0 dB) .....	2.0 $\pm$ 0.5 V

## Laser Diode Properties

Type .....	Semiconductor laser GaAlAs
Wavelength .....	790 nm
Output Power .....	1.23 mW (max)

## General

Power requirements	
U.S.A. and Canada models .....	120 V, 60 Hz
Australia model .....	240 V, 50 Hz
Europe and U.K. models .....	230 V, 50 Hz
Asia and General models	
.....	110/120/220/230-240 V, 50/60 Hz
China model .....	220 V, 50 Hz
Power consumption .....	12 W
Dimensions (W x H x D) .....	435 x 116 x 403 mm (17-1/8" x 4-9/16" x 15-7/8")
Weight .....	5.5 kg (12 lbs. 125 oz.)

Please note that all specifications are subject to change without notice.

**CAUTION**

Use of controls or adjustments or performance of procedures other than those specified herein may result in hazardous radiation exposure.

**VARO!**

AVATTAESSA JA SUOJALUKITUS OHITETTAESSA OLET ALTTIINA NÄKYMÄTTÖMÄLLE LASERSÄTEILYLLE. ÄLÄ KATSO SÄTEESEEN.

**WARNING!**

OSYNLIG LASERSTRÅLNING NÄR DENNA DEL ÄR ÖPPNAD OCH SPÄRREN ÄR URKOPPLAD. BETRAKTA EJ STRÅLEN.

CLASS 1 LASER PRODUCT  
LASER KLASSE 1 PRODUKT  
LUOKAN 1 LASERLAITE  
KLASS 1 LASER APPARAT  
PRODUIT LASER DE CLASSE 1

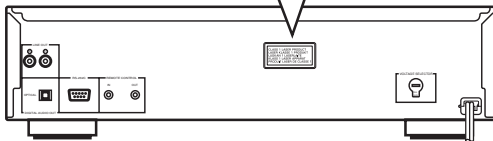

(Example: General model)

CAUTION - VISIBLE AND / OR INVISIBLE LASER RADIATION WHEN OPEN. AVOID EXPOSURE TO BEAM.  
VARNING - SYNLIG OCH / ELLER OSYNLIG LASERSTRÅLNING NÄR DENNA DEL ÄR ÖPPNAD. STRÅLEN ÄR FARLIG.  
VARO! AVATTAESSA OLET ALTTIINA NÄKYMÄLLE JA / TA NÄKYMÄTTÖMÄLLE LASERSÄTEILYLLE. ÄLÄ KATSO SÄTEESEEN.  
VARNING - SYNLIG OCH / ELLER OSYNLIG LASERSTRÅLNING NÄR DENNA DEL ÄR ÖPPNAD. BETRAKTA EJ STRÅLEN.  
VORSICHT! SICHTBARE UND / ODER UNSICHTBARE LASERSTRÄHLUNG WENN ABDECKUNG GEÖFFNET. NICHT DEM STRAHL AUSSETZEN.

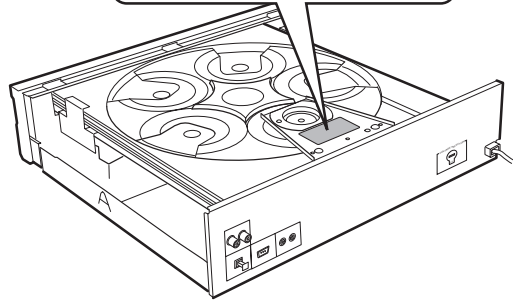

(Example: General model)

**CAUTION**  
VISIBLE AND INVISIBLE LASER RADIATION WHEN OPEN. AVOID EXPOSURE TO BEAM.







© 2006 YAMAHA CORPORATION All rights reserved.

**YAMAHA ELECTRONICS CORPORATION, USA** 6660 ORANGETHORPE AVE., BUENA PARK, CALIF. 90620, U.S.A.  
**YAMAHA CANADA MUSIC LTD.** 135 MILNER AVE., SCARBOROUGH, ONTARIO M1S 3R1, CANADA  
**YAMAHA ELECTRONIK EUROPA G.m.b.H.** SIEMENSSTR. 22-34, 25462 RELLINGEN, BEI HAMBURG, GERMANY  
**YAMAHA ELECTRONIQUE FRANCE S.A.** RUE AMBROISE CROIZAT BP70 CROISSY-BEAUBOURG 77312 MARNE-LA-VALLÉE CEDEX02, FRANCE  
**YAMAHA ELECTRONICS (UK) LTD.** YAMAHA HOUSE, 200 RICKMANSWORTH ROAD WATFORD, HERTS WD18 7GQ, ENGLAND  
**YAMAHA SCANDINAVIA A.B.** J. A. WETTERGRENS GATA 1, BOX 30053, 400 43 VÄSTRA FRÖLUNDA, SWEDEN  
**YAMAHA MUSIC AUSTRALIA PTY, LTD.** 17-33 MARKET ST., SOUTH MELBOURNE, 3205 VIC., AUSTRALIA

YAMAHA CORPORATION

Printed in Malaysia ◀ WH52590