



ELECTRIC GUITAR

OWNER'S MANUAL

CONTENTS

CARE AND MAINTENANCE.....	2	VIBRATO SYSTEM Locking Type (part 2)	7
TUNING MACHINE TENSION ADJUSTMENT	3	BRIDGE/SPRING TENSION ADJUSTMENTS	8
HEIGHT ADJUSTABLE LOCKING NUT	3	TRUSS ROD ADJUSTMENT	9
SETTING THE STRING ACTION	4	PICKUP HEIGHT ADJUSTMENT	9
VIBRATO SYSTEM Vintage Type	5	CORRECT USE AND HANDLING OF BATTERIES.....	10
VIBRATO SYSTEM Locking Type (part 1)	6	Safety Precautions.....	11

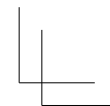
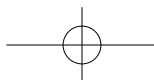

*Congratulations on your purchase of the
YAMAHA electric guitar.
With reasonable care, your YAMAHA elec-
tric guitar will age gracefully and provide
many years of superlative musical service.*

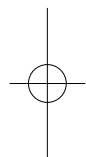

CARE AND MAINTENANCE

- * When connecting or disconnecting cables, turn off the amplifier and other equipment or reduce the volume.
- * After playing, wipe the entire guitar down, including strings, with a good polishing cloth. This will remove corrosive skin oils and acids, and protect the plating, finish, and strings.
- * Avoid exposing the guitar to direct sunlight and extremes of heat and humidity.

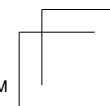
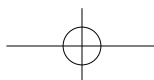
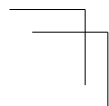
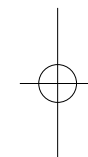

TUNING MACHINE TENSION ADJUSTMENT

The tuning machines have spring-loaded mechanisms which automatically take up wear, preventing backlash. However, it is possible to adjust the amount of pressure required to turn the machines. Each machine has a tension adjustment screw, as illustrated.

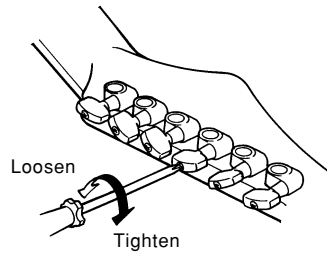

Clockwise screw rotation tightens the machine. The tuning machines should be adjusted to the extent that they are firm, but can turn smoothly. This adjustment is normally unnecessary, and excessive tightening can lead to premature tuning machine wear.

HEIGHT ADJUSTABLE LOCKING NUT

- 1) Remove 3 pcs. of hexagonal screws fixing the Lock Pads. (illustration — A)
- 2) Loosen 4 pcs. of screws fixing the Nut Base. (illustration — B)
- 3) Adjust the height by the Height Adjustment Screw. The Nut Base gets higher by clockwise rotation, and lower by counterclockwise rotation. (illustration — C)

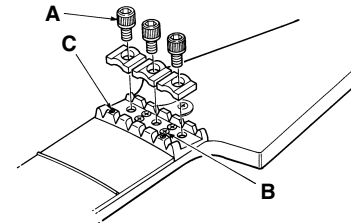

NOTE: As the height has been adjusted in the best condition in the factory, please avoid the adjustment unless you have suitable experience. We suggest that you entrust this adjustment to your dealer.

SETTING THE STRING ACTION

— Bridge —

NOTE: Be sure to perform any necessary adjustments to the truss rod before performing the following adjustments.

String height refers to the space between the strings and frets, and has an effect on playability.

String height is adjusted with the bridge and/or the saddle on the bridge. Adjust height by alternately turning the screws little by little on the left and right sides.

Set too high and the instrument is hard to play. Too low results in fret noise.

Adjust so that the space between the string and the last fret measures as follows:

String	Tuning	Height
1st	E	1.9 mm
2nd	B	2.0 mm
3rd	G	2.1 mm
4th	D	2.2 mm
5th	A	2.3 mm
6th	E	2.4 mm

Height adjustment screws
(for each strings)

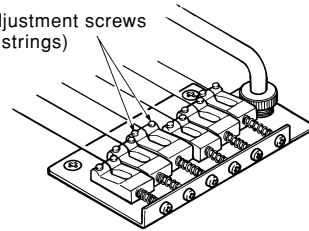

Height adjustment screw

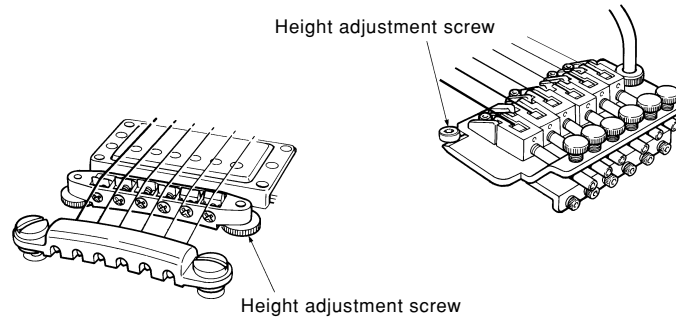

VIBRATO SYSTEM Vintage Type

Following is the procedure for adjusting the vintage vibrato system:

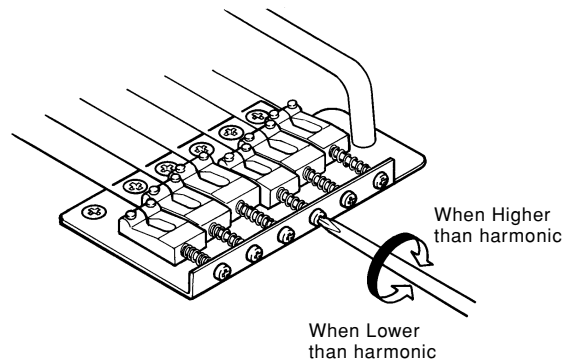

To check intonation, compare the harmonic tone (12th fret) to the fretted tone (12th fret).

- If fretted pitch is higher than harmonic, saddle must be moved backward to lengthen string.

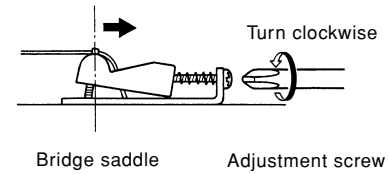

- If fretted pitch is lower than harmonic, saddle must be moved forward to shorten string.

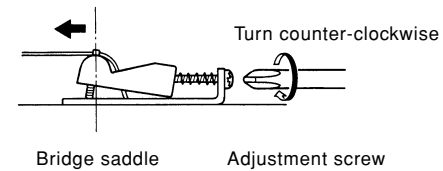

VIBRATO SYSTEM Locking Type (part 1)

When changing strings it is necessary to cut off the ball ends of the strings.

Following is the procedure for changing strings and adjusting the vibrato system:

- 1) Using the supplied hexagonal wrench, loosen the three hexagonal screws on the lock above the nut. (illustration — A)
- 2) Loosen the individual string locks using the supplied hexagonal wrench. (illustration — B)
- 3) Replace the old strings with new strings.
- 4) Using the hexagonal wrench, lock each string. (illustration — B)
After locking the strings, make sure that the fine tuning thumb screws are in the middle of their range of travel. (illustration — C)
- 5) Tune the guitar to the correct pitch.
- 6) Remove the back plate to gain access to the vibrato strings. Three springs are factory installed and we recommend that these springs be adjusted so that the vibrato bridge plate is parallel to the top of the guitar when it is tuned to correct pitch.

7) Lock the strings above the nut. (illustration — A)

8) Use the fine tuning thumb screw to tune the guitar to the correct pitch. (illustration — C)

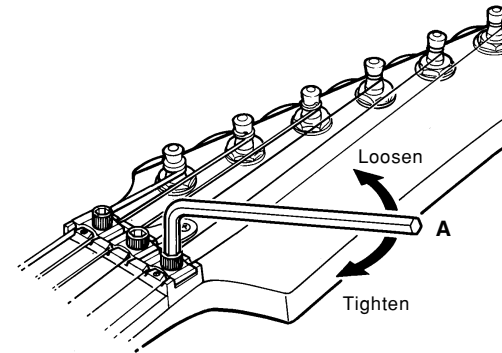

VIBRATO SYSTEM Locking Type (part 2)

Intonation Adjustment in Vibrato Bridge

- 1) Loosen the hexagonal screw located in front of each saddle using the supplied hexagonal wrench. (illustration — D)
- 2) Slide the saddles by hand to adjust the length of each string.
- 3) When the intonation is correct, tighten the hexagonal screw in front of each saddle to ensure that its position stays stationary. (illustration — D)

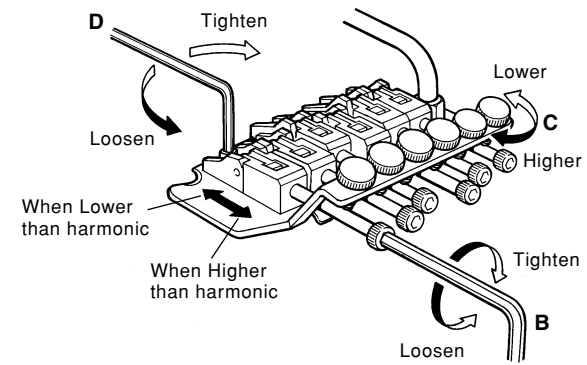

BRIDGE/SPRING TENSION ADJUSTMENTS

For best results the bridge should always be adjusted so it is parallel to the top surface of the guitar as shown in illustration (below). This position is maintained by opposing tension between the strings and the claw springs. If you change string gauge, you will need to readjust the spring tension to return the bridge back to the parallel position.

The adjustment procedures are:

- 1) Remove the screws that attach the tremolo cavity back plate from the back side of the guitar exposing the claw springs.
- 2) Make sure that the guitar is tuned to proper pitch.
- 3) If the bridge is tilted forward (up), tighten spring tension by turning the claw screws clockwise. If the bridge is tilted back (down), loosen the spring tension by turning the claw screws counterclockwise.

(illustration — A)

Be sure to check string pitch after each adjustment to the spring tension.

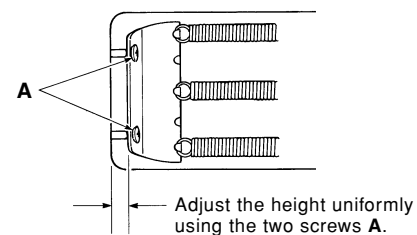
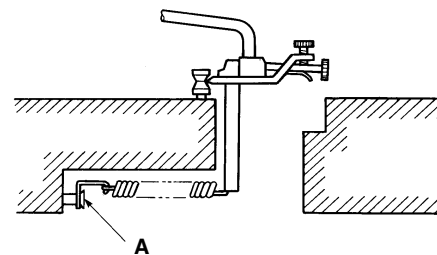

TRUSS ROD ADJUSTMENT

The curvature of the neck should be slightly concave. Clockwise rotation of the nut tightens the rod and corrects for too much concave bow. Counterclockwise rotation of the nut loosens the rod and corrects for too much convex bend. Make any adjustments gradually. Allow five to ten minutes for setting, and check the curvature after each 1/2 turn of the truss rod nut.

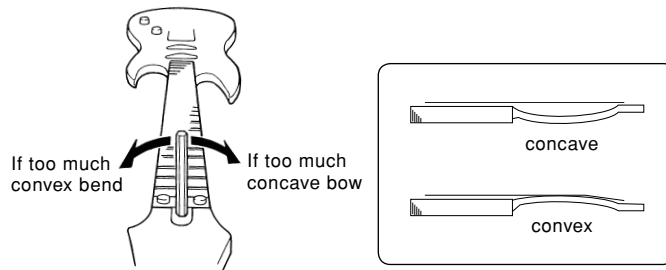

NOTE: Unless you have experience with truss rods, we suggest that you entrust this adjustment to your dealer.

PICKUP HEIGHT ADJUSTMENT

The height of the pickup (i.e. distance from the strings) affects gain — the higher the pickup, the louder the sound, and vice versa. If the pickup is set too high, sustain and playability will suffer because of the magnetic pull on the strings. Adjust overall height using the screws located at either side of the pickup. If the pickup has individually adjustable polepieces (most humbuckers do), these can then be adjusted to achieve the best overall balance. The polepieces should normally be about 2 or 3 millimeters from the strings.

Single-coil Pickup

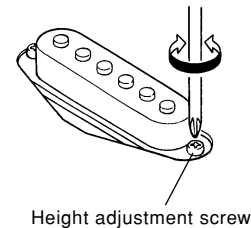

Humbucking Pickup

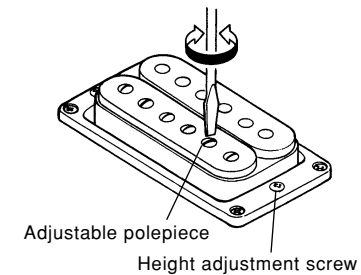

CORRECT USE AND HANDLING OF BATTERIES

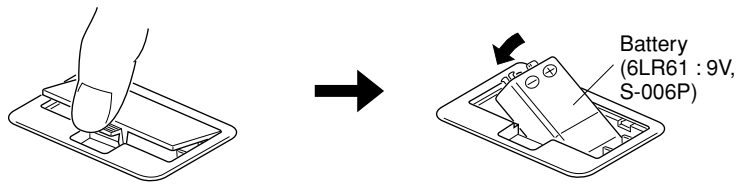
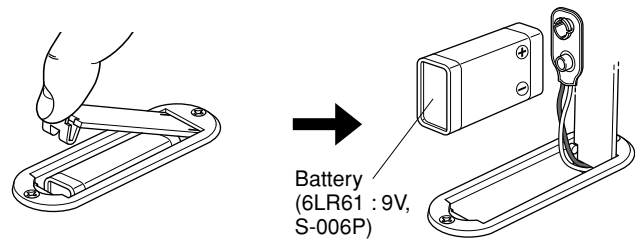

* When changing batteries, pay close attention to the +/- polarity markings as shown in the illustration above.

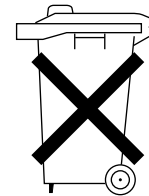

When these run out, don't just throw them away, but dispose of them as minor chemical waste.

Thank you for purchasing this Yamaha Guitar.
To get the most out of this fine instrument, and to use it in a safe manner, we urge you to read this Owner's Manual before using the instrument.
The cautions given in the following Safety Precautions section are provided to prevent unexpected injuries or accidents. Please understand each of the cautions and use the instrument in a safe and proper manner.



Caution

Safety Precautions

Using your Yamaha Guitar in a Safe Manner

Preventing Unexpected Injuries and Accidents

- When using a strap, make sure the strap is securely attached to the guitar.
- Do not lift the guitar by strap. It can cause serious injury or damage to the guitar.
- Do not treat the instrument in a rough manner such as swinging it about, etc.
The strap on the guitar may detach causing unexpected accidents such as the instrument dropping, etc., or injuring persons close by.



- Do not place your face close to the instrument when changing or adjusting the strings. Strings may suddenly break causing injuries to eyes, etc. It can be the cause of other unexpected injuries as well.



- After changing the strings, cut off the leftover string ends. String ends are sharp and can cause injuries.
- Clean the instrument with a soft, dry cloth. And when cleaning the headstock, be careful not to injure yourself on the sharp string ends.

Using Batteries Properly

- For guitars that use a battery, make sure that only the specified battery is used and it is installed with its polarity markings aligned properly.
- On guitars that require two or more batteries, do not mix new batteries with old.
Improper use of batteries can result in the batteries rupturing or leaking, causing injury or damage.
- Never incinerate batteries.
Separate batteries from household garbage and dispose of them in a proper manner.



Preventing Electrical Accidents

- If the instrument must be used outdoors in bad weather, or in a place with high humidity, please use caution. Please read the Owner's Manuals that came with the devices, such as power amplifiers, etc., that you connect your guitar to.
Accidents such as fire or electric shock can occur due to lightning strikes.

Store the Instrument Properly

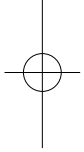
- 
- Do not keep the instrument close to a fire or flame, and keep it on a low, stable surface.
The instrument can catch fire, and earthquakes can cause it to fall if stored in a high location.
 - Do not leave the instrument leaning against the wall, etc., in the vicinity of children.
The instrument may be bumped causing it to fall over resulting in injury.
 - If the instrument is not going to be used for an extended period of time, remove the batteries and keep the instrument in a place other than those listed below.
 - Locations subject to direct sunlight.
 - Locations subject to extremely high or low temperatures.
 - Locations subject to high humidity, dust, or vibration.
 - During the summer season, temperatures inside of a -car can become extremely hot. Do not leave the instrument inside of a car.

Be Careful When Handling and Other Cautions

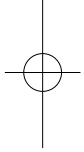
- 
- The guitar has been properly adjusted before being shipped from the factory. In the event adjustment is necessary, contact the dealer from whom you purchased the instrument, if possible, as special skills may be required. For those adjustments that can be performed by the owner, please closely follow the instructions given in the Owner's Manual for the procedure.
 - When playing the instrument, pay attention to the volume level. Especially late at night, take neighbors and those who are close by into consideration.
 - Broken guitar necks are mostly the result of accidents such as dropping the guitar, the guitar falling over, or from shocks occurred during transport. When the guitar is not being used, make sure it is kept on a sturdy stand where it won't fall over, or place it in its case.
 - Do not treat the instrument in a rough manner like throwing objects at the instrument, dropping the instrument, etc. And do not put excessive force on the switches or control knobs, etc.
Doing so can result in damage.
 - When connecting or disconnecting the cable, make sure the guitar amplifier's power is switched OFF, or the amplifier's volume is turned all the way down.
Not doing so can shorten the life of the guitar amplifier.
 - When cleaning the instrument, use a soft, dry cloth. Also, do not spray insecticides close to the instrument.
Doing so can damage the guitar's finish.

Yamaha Representative Offices in Europe

AUSTRIA

Yamaha Music Europe GmbH
Branch Austria
Schleiergasse 20, A-1100 Wien Austria
Tel: +43 (0)1 602 03900
Fax: +43 (0)1 602 039051

BELGIUM

Yamaha Music Europe
Branch Benelux
Clarissenhof 5b NL, 4133 AB. Vianen
The Netherlands
Tel: +31 (0)347 358040
Fax: +31 (0)347 358060

BULGARIA

Yamaha Music Europe GmbH
Branch Austria (Central and Eastern Europe)
Schleiergasse 20, A-1100 Wien Austria
Tel: +43 (0)1 602 03900
Fax: +43 (0)1 602 039051

CYPRUS

NAKAS Music Cyprus Ltd.
31C Nikis Ave., 1086 Nicosia
Tel: +357 (0)22 510 477
Fax: +357 (0)22 511 080

CZECH REPUBLIC

Yamaha Music Europe GmbH
Branch Austria (Central and Eastern Europe)
Schleiergasse 20, A-1100 Wien Austria
Tel: +43 (0)1 602 03900
Fax: +43 (0)1 602 039051

DENMARK

YS Copenhagen Liaison Office
(Yamaha Scandinavia AB Filial Denmark)
Generatorvej 6A, 2730 Herlev, Denmark
Tel: +45 44 92 49 00
Fax: +45 44 54 47 09

ESTONIA

Yamaha Music Europe GmbH
Sp. z o.o. Oddział w Polsce
(Branch Poland)
ul. 17 Stycznia 56
PL-02-146 Warszawa Poland
Tel: +48 (0)22 500 29 25
Fax: +48 (0)22 500 29 30

FINLAND

(For Musical Instrument)
F - Musiikki OY
Kaisaniemenkatu 7, PL260
00101 Helsinki, Finland
Tel: +358 (0)9 618511
Fax: +358 (0)9 61851385

(For Pro Audio)

Yamaha Scandinavia AB
J A Wettergrens gata 1
Västra Frölunda, Sweden
(Box 300 53, 400 43 Goteborg
Sweden - Postal Address)
Tel: +46 (0)31 893400
Fax: +46 (0)31 454026

FRANCE

Yamaha Musique France
Zone d'activité de Pariest
7, rue Ambroise Croizat
77183 Croissy-Beaubourg, France
(B.P. 70, 77312 Marne la Vallée Cedex 2
France-Adresse postale)
Tel: +33 (0)1 64 61 4000
Fax: +33 (0)1 64 61 4079

GERMANY

Yamaha Music Europe GmbH
Siemensstr 22-34
D-25462 Rellingen, b. Hamburg, Germany
Tel: +49 (0)4101 3030
Fax: +49 (0)4101 303 77702

GREECE

PH. Nakas S.A.Music House/Service
19 KM Leoforos Lavriou
19002 Peania / Attiki, Greece
Tel: +30 (0)210 6686260
Fax: +30 (0)210 6686269

HUNGARY

Yamaha Music Europe GmbH
Branch Austria (Central and Eastern Europe)
Schleiergasse 20, A-1100 Wien Austria
Tel: +43 (0)1 602 03900
Fax: +43 (0)1 602 039051

ICELAND

(For Musical Instrument)
HLJODFAERAHUSID EHF
Sidumula 20
108 Reykjavik, Iceland
Tel: +354 525 50 50
Fax: +354 568 65 14

(For Pro Audio)

Yamaha Scandinavia AB
J A Wettergrens gata 1
Västra Frölunda, Sweden
(Box 300 53, 400 43 Goteborg
Sweden - Postal Address)
Tel: +46 (0)31 893400
Fax: +46 (0)31 454026

IRELAND (REPUBLIC OF IRELAND)

Yamaha Music UK Ltd.
Sherbourne Drive
Tilbrook, Milton Keynes MK7 8BL
United Kingdom
Tel: +353 (0) 1526 2449
Fax: +44 (0) 1908 369278

ITALY

Yamaha Musica Italia s.p.a.
Viale Italia 88
20020, Lainate (Milano), Italy
Tel: +39 (0)02 93577 1
Fax: +39 (0)02 937 0956

LATVIA

Yamaha Music Europe GmbH
Sp. z o.o. Oddział w Polsce
(Branch Poland)
ul. 17 Stycznia 56
PL-02-146 Warszawa Poland
Tel: +48 (0)22 500 29 25
Fax: +48 (0)22 500 29 30

LIECHTENSTEIN

Yamaha Music Europe GmbH, Rellingen,
Branch Switzerland in Zurich
Seefeldstrasse 94, CH-8008
Zürich, Switzerland
Tel: +41 (0)1 3833990
Fax: +41 (0)1 3833918

LITHUANIA

Yamaha Music Europe GmbH
Sp. z o.o. Oddział w Polsce
(Branch Poland)
ul. 17 Stycznia 56
PL-02-146 Warszawa Poland
Tel: +48 (0)22 500 29 25
Fax: +48 (0)22 500 29 30

LUXEMBOURG

Yamaha Music Europe
Branch Benelux
Clarissenhof 5b NL, 4133 AB. Vianen
The Netherlands
Tel: +31 (0)347 358040
Fax: +31 (0)347 358060

MALTA

Olimpus Music Ltd.
The Emporium, Level 3, St. Louis Street
Msida MSD06
Tel: +356 (0)2133 2093
Fax: +356 (0)2133 2144

NETHERLANDS

Yamaha Music Europe
Branch Benelux
Clarissenhof 5b NL, 4133 AB. Vianen
The Netherlands
Tel: +31 (0)347 358040
Fax: +31 (0)347 358060

NORWAY

YS Oslo Liaison Office
(Yamaha Scandinavia AB Filial Norway)
Grini Naeringspark 1
1361 Osteras, Norway
Tel: +47 67 16 77 70
Fax: +47 67 16 77 79

POLAND

YAMAHA Music Europe GmbH
Sp. z o.o. Oddział w Polsce
ul. 17 Stycznia 56
02-146 WARSZAWA/POLSKA
Tel: +48 (0)22 500 29 25
Fax: +48 (0)22 500 29 30

PORTUGAL

Yamaha Música Ibérica, S.A.U.
Sucursal Portuguesa
Rua Alfredo da Silva
2610-016 Amadora, Portugal
Tel: +351 214 704 330
Fax: +351 214 718 220

ROMANIA

Yamaha Music Europe GmbH
Branch Austria (Central and Eastern Europe)
Schleiergasse 20, A-1100 Wien Austria
Tel: +43 (0)1 602 03900
Fax: +43 (0)1 602 039051

SLOVAKIA

Yamaha Music Europe GmbH
Branch Austria (Central and Eastern Europe)
Schleiergasse 20, A-1100 Wien Austria
Tel: +43 (0)1 602 03900
Fax: +43 (0)1 602 039051

SLOVENIA

Yamaha Music Europe GmbH
Branch Austria (Central and Eastern Europe)
Schleiergasse 20, A-1100 Wien Austria
Tel: +43 (0)1 602 03900
Fax: +43 (0)1 602 039051

SPAIN

Yamaha Música Ibérica, S.A.U.
Ctra. de la Coruna km.17, 200
28230 Las Rozas de Madrid, Spain
Tel: +34 902 39 8888
Fax: +34 91 638 4660

SWEDEN

Yamaha Scandinavia AB
J A Wettergrens gata 1
Västra Frölunda, Sweden
(Box 300 53, 400 43 Goteborg
Sweden - Postal Address)
Tel: +46 (0)31 893400
Fax: +46 (0)31 454026

SWITZERLAND

Yamaha Music Europe GmbH, Rellingen,
Branch Switzerland in Zurich
Seefeldstrasse 94, CH-8008
Zürich, Switzerland
Tel: +41 (0)1 3833990
Fax: +41 (0)1 3833918

UNITED KINGDOM

Yamaha Music UK Ltd.
Sherbourne Drive
Tilbrook, Milton Keynes MK7 8BL
United Kingdom
Tel: +44 (0) 870 4445575
Fax: +44 (0) 1908 369278



お問い合わせ

- お買い上げのギターの使用法や取り扱いについては、ご購入店または下記ヤマハお客様コミュニケーションセンターへお問い合わせください。

お客様コミュニケーションセンター 管弦打楽器相談窓口

ナビダイヤル



0570-013-808

(全国共通番号)

* 一般電話・公衆電話からは、市内通話料金でご利用いただけます。

携帯電話、PHS、IP 電話からは、TEL.053-411-4744

営業時間：月～金 10:00～18:00 / 土 10:00～17:00 (祝日およびセンター指定休日を除く)

<http://www.yamaha.co.jp/support/>

- 修理につきましては、ご購入店または下記窓口までご相談ください。

<アコースティックギター>

ご購入店までご相談ください。

<エレクトリック・アコースティック・ギター、サイレントギター、エレキギター、エレキベース>

ヤマハ修理ご相談センター

ナビダイヤル



0570-012-808

(全国共通番号)

* 一般電話・公衆電話からは、市内通話料金でご利用いただけます。

携帯電話、PHS、IP 電話からは、TEL.053-460-4830

営業時間：月～金 9:00～18:00、/ 土 9:00～17:00 (祝日およびセンター指定休日を除く)

北海道サービスステーション 〒064-8543 札幌市中央区南 10 条西 1-1-50 ヤマハセンター内

首都圏サービスセンター 〒143-0006 東京都大田区平和島 2-1-1 京浜トラックターミナル内 14 号棟 A-5F

浜松サービスステーション 〒435-0016 浜松市東区和田町 200

名古屋サービスセンター 〒454-0058 名古屋市中川区玉川町 2-1-2 ヤマハ (株) 名古屋流通センター 3F

大阪サービスセンター 〒564-0052 吹田市広芝町 10-28 オーク江坂ビルディング 2F

九州サービスステーション 〒812-8508 福岡市博多区博多駅前 2-11-4

管弦打楽器事業部 GD 推進部 マーケティンググループ 〒438-0192 静岡県磐田市松之木島 203

※住所及び電話番号は変更になる場合があります。

SERVICE / KUNDENDIENST / APRES-VENTE / SERVICIO TÉCNICO / ASSISTENZA TECNICA / POMOHT / 售后服务 / 서비스

If your guitar should need any parts or service, or if you need any information, including the address of your nearest YAMAHA dealer, contact:

Für Ersatzteile, Kundendienstfälle oder Informationen jeglicher Art, einschließlich der Adresse des nächstgelegenen YAMAHA-Händlers, wenden Sie sich bitte an:

Si vous avez besoin d'une pièce, si la guitare doit être réparée, ou si vous avez besoin d'informations, y compris l'adresse du distributeur YAMAHA le plus proche, adressez-vous à:

En caso de requerir alguna pieza o el servicio técnico de la guitarra, así como si necesita alguna información, como pueda ser la dirección del distribuidor YAMAHA que esté más cerca de su casa, póngase en contacto con:

Se la vostra chitarra dovesse richiedere parti o assistenza tecnica o se aveste bisogno di qualsiasi informazione, compreso l'indirizzo del più vicino rivenditore autorizzato di prodotti Yamaha, entrare in contatto con:

Если для гитары требуются запчасти или ремонт, а также если необходимо получить какую-либо информацию, включая адрес ближайшего дилера YAMAHA, обращайтесь:

如果您的吉他需要任何配件或维修，或者您需要任何信息，请找到离您最近的 YAMAHA 分销商并与我们联系。

기타의 부품 또는 서비스가 필요하거나 정보가 필요한 경우 가까운 YAMAHA 판매점에 문의하십시오.

Yamaha Corporation of America Guitar Service Department

6600 Orangethorpe Ave.,
Buena Park, Calif. 90620, U.S.A.
Tel: 714-522-9011

Yamaha Canada Music Ltd.

135 Milner Avenue, Scarborough,
Ontario, M1S 3R1, Canada
Tel: 416-298-1311

Yamaha de México S.A. de C.V.

Calz. Javier Rojo Gómez #1149,
Col. Guadalupe del Moral
C.P. 09300, México, D.F., México
Tel: 55-5804-0600

Yamaha Music Latin America, S.A. Sucursal de Argentina

Olga Cossetini 1553, Piso 4 Norte
Madero Este-C1107CEK
Buenos Aires, Argentina
Tel: 011-4119-7000

Yamaha Music Latin America, S.A.

Torre Banco General, Piso 7, Urbanización
Marbella, Calle 47 y Aquilino de la Guardia,
Ciudad de Panamá, Panamá
Tel: +507-269-5311

Yamaha Music Australia Pty. Ltd.

Level 1, 99 Queensbridge Street,
Southbank, Victoria 3006, Australia
Tel: 3-9693-5111

ООО «ЯМАХА МЮЗИК» (РОССИЯ)

Россия, 107996, Москва, Кузнецкий мост,
д.21/5, подъезд 2, офис 4015
Тел.: (495) 626 0660 Факс: (495) 626 0062

Yamaha Music & Electronics (China) Co., Ltd.

2F, Yunhedasha, 1818 Xinzha-lu, Jingan-qu,
Shanghai, China
Tel: 021-6247-2211

YAMAHA MUSIC KOREA LTD.

Dongsung Bldg, 8F/9F 158-9
Samsung-dong, Kangnam-gu, Seoul, Korea
전화: 02-3467-3300

WS31060 R0

YAMAHA

0904 Printed in Japan