



YAMAHA  
Clavinova  
CLP-170/CLP-150

# Clavinova<sup>®</sup>

## CLP-170

## CLP-150

### Owner's Manual

**IMPORTANT**

**Check your power supply**

Make sure that your local AC mains voltage matches the voltage specified on the name plate on the bottom panel. In some areas a voltage selector may be provided on the bottom panel of the main keyboard unit near the power cord. Make sure that the voltage selector is set for the voltage in your area. The voltage selector is set at 240V when the unit is initially shipped. To change the setting use a "minus" screwdriver to rotate the selector dial so that the correct voltage appears next to the pointer on the panel.

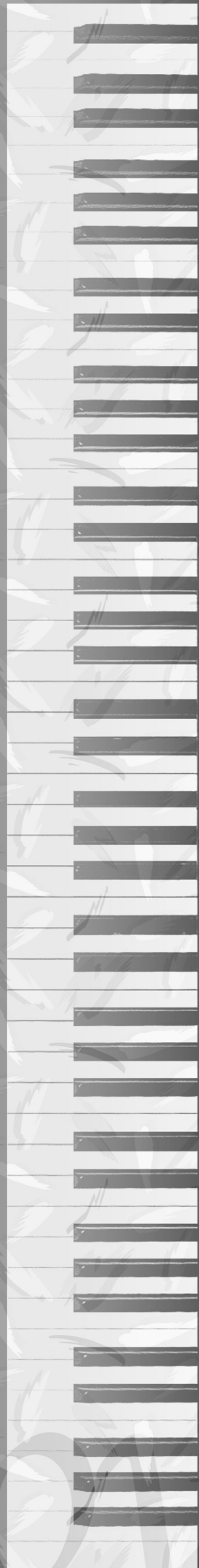

# SPECIAL MESSAGE SECTION

**PRODUCT SAFETY MARKINGS:** Yamaha electronic products may have either labels similar to the graphics shown below or molded/stamped facsimiles of these graphics on the enclosure. The explanation of these graphics appears on this page. Please observe all cautions indicated on this page and those indicated in the safety instruction section.

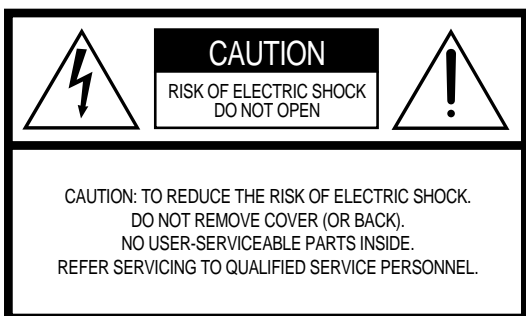

See bottom of Keyboard enclosure for graphic symbol markings



The exclamation point within the equilateral triangle is intended to alert the user to the presence of important operating and maintenance (servicing) instructions in the literature accompanying the product.

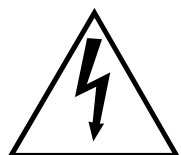

The lightning flash with arrowhead symbol, within the equilateral triangle, is intended to alert the user to the presence of uninsulated “dangerous voltage” within the product’s enclosure that may be of sufficient magnitude to constitute a risk of electrical shock.

**IMPORTANT NOTICE:** All Yamaha electronic products are tested and approved by an independent safety testing laboratory in order that you may be sure that when it is properly installed and used in its normal and customary manner, all foreseeable risks have been eliminated. DO NOT modify this unit or commission others to do so unless specifically authorized by Yamaha. Product performance and/or safety standards may be diminished. Claims filed under the expressed warranty may be denied if the unit is/has been modified. Implied warranties may also be affected.

**SPECIFICATIONS SUBJECT TO CHANGE:** The information contained in this manual is believed to be correct at the time of printing. However, Yamaha reserves the right to change or modify any of the specifications without notice or obligation to update existing units.

**ENVIRONMENTAL ISSUES:** Yamaha strives to produce products that are both user safe and environmentally friendly. We sincerely believe that our products and the production methods used to produce them, meet these goals. In keeping with both the letter and the spirit of the law, we want you to be aware of the following:

**Battery Notice:** This product MAY contain a small non-rechargeable battery which (if applicable) is soldered in place. The average life span of this type of battery is approximately five years. When replacement becomes necessary, contact a qualified service representative to perform the replacement.

**Warning:** Do not attempt to recharge, disassemble, or incinerate this type of battery. Keep all batteries away from children. Dispose of used batteries promptly and as regulated by applicable laws. Note: In some areas, the servicer is required by law to return the defective parts. However, you do have the option of having the servicer dispose of these parts for you.

**Disposal Notice:** Should this product become damaged beyond repair, or for some reason its useful life is considered to be at an end, please observe all local, state, and federal regulations that relate to the disposal of products that contain lead, batteries, plastics, etc.

**NOTICE:** Service charges incurred due to lack of knowledge relating to how a function or effect works (when the unit is operating as designed) are not covered by the manufacturer’s warranty, and are therefore the owners responsibility. Please study this manual carefully and consult your dealer before requesting service.

**NAME PLATE LOCATION:** The graphic below indicates the location of the name plate. The model number, serial number, power requirements, etc., are located on this plate. You should record the model number, serial number, and the date of purchase in the spaces provided below and retain this manual as a permanent record of your purchase.

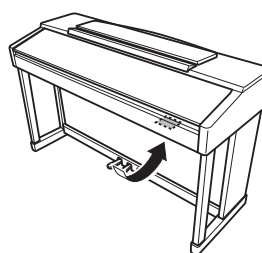

CLP-170

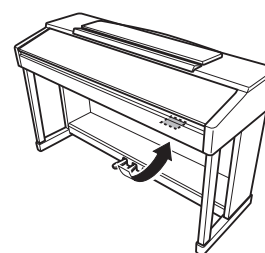

CLP-150

**Model** \_\_\_\_\_

**Serial No.** \_\_\_\_\_

**Purchase Date** \_\_\_\_\_

# PRECAUTIONS

## PLEASE READ CAREFULLY BEFORE PROCEEDING

\* Please keep this manual in a safe place for future reference.

### **WARNING**

Always follow the basic precautions listed below to avoid the possibility of serious injury or even death from electrical shock, short-circuiting, damages, fire or other hazards. These precautions include, but are not limited to, the following:

#### **Power supply/Power cord**

- Only use the voltage specified as correct for the instrument. The required voltage is printed on the name plate of the instrument.
- Check the electric plug periodically and remove any dirt or dust which may have accumulated on it.
- Use only the supplied power cord/plug.
- Do not place the power cord near heat sources such as heaters or radiators, and do not excessively bend or otherwise damage the cord, place heavy objects on it, or place it in a position where anyone could walk on, trip over, or roll anything over it.

#### **Do not open**

- Do not open the instrument or attempt to disassemble the internal parts or modify them in any way. The instrument contains no user-serviceable parts. If it should appear to be malfunctioning, discontinue use immediately and have it inspected by qualified Yamaha service personnel.

#### **Water warning**

- Do not expose the instrument to rain, use it near water or in damp or wet conditions, or place containers on it containing liquids which might spill into any openings.
- Never insert or remove an electric plug with wet hands.

#### **Fire warning**

- Do not put burning items, such as candles, on the unit. A burning item may fall over and cause a fire.

#### **If you notice any abnormality**

- If the power cord or plug becomes frayed or damaged, or if there is a sudden loss of sound during use of the instrument, or if any unusual smells or smoke should appear to be caused by it, immediately turn off the power switch, disconnect the electric plug from the outlet, and have the instrument inspected by qualified Yamaha service personnel.

### **CAUTION**

Always follow the basic precautions listed below to avoid the possibility of physical injury to you or others, or damage to the instrument or other property. These precautions include, but are not limited to, the following:

#### **Power supply/Power cord**

- When removing the electric plug from the instrument or an outlet, always hold the plug itself and not the cord. Pulling by the cord can damage it.
- Remove the electric plug from the outlet when the instrument is not to be used for extended periods of time, or during electrical storms.
- Do not connect the instrument to an electrical outlet using a multiple-connector. Doing so can result in lower sound quality, or possibly cause overheating in the outlet.

#### **Assembly**

- Read carefully the attached documentation explaining the assembly process. Failure to assemble the instrument in the proper sequence might result in damage to the instrument or even injury.

#### **Location**

- Do not expose the instrument to excessive dust or vibrations, or extreme cold or heat (such as in direct sunlight, near a heater, or in a car during the day) to prevent the possibility of panel disfiguration or damage to the internal components.
- Do not use the instrument in the vicinity of a TV, radio, stereo equipment, mobile phone, or other electric devices. Otherwise, the instrument, TV, or radio may generate noise.
- Do not place the instrument in an unstable position where it might accidentally fall over.
- Before moving the instrument, remove all connected cables.
- Do not place the instrument against a wall (allow at least 3 cm/ one-inch from the wall), since this can cause inadequate air circulation, and possibly result in the instrument overheating.

## Connections

- Before connecting the instrument to other electronic components, turn off the power for all components. Before turning the power on or off for all components, set all volume levels to minimum. Also, be sure to set the volumes of all components at their minimum levels and gradually raise the volume controls while playing the instrument to set the desired listening level.

## Maintenance

- In the case of a model with a polished finish, gently remove dust and dirt with a soft cloth. Do not wipe too hard since small particles of dirt can scratch the instrument's finish.
- When cleaning the instrument, use a soft, dry or slightly damp cloth. Do not use paint thinners, solvents, cleaning fluids, or chemical-impregnated wiping cloths.

## Handling caution

- Take care that the key cover does not pinch your fingers, and do not insert a finger or hand in any gaps on the key cover or instrument.
- Never insert or drop paper, metallic, or other objects into the gaps on the key cover, panel or keyboard. If this happens, turn off the power immediately and unplug the power cord from the AC outlet. Then have the instrument inspected by qualified Yamaha service personnel.
- Do not place vinyl, plastic or rubber objects on the instrument, since this might discolor the panel or keyboard.
- In the case of a model with a polished finish, bumping the surface of the instrument with metal, porcelain, or other hard objects can cause the finish to crack or peel. Use caution.
- Do not rest your weight on, or place heavy objects on the instrument, and do not use excessive force on the buttons, switches or connectors.
- Do not operate the instrument for a long period of time at a high or uncomfortable volume level, since this can cause permanent hearing loss. If you experience any hearing loss or ringing in the ears, consult a physician.

## Using the bench (If included)

- Do not place the bench in an unstable position where it might accidentally fall over.
- Do not play carelessly with or stand on the bench. Using it as a tool or step-ladder or for any other purpose might result in accident or injury.
- Only one person should sit on the bench at a time, in order to prevent the possibility of accident or injury.
- In the case of a model which the height adjustable bench included, do not attempt to adjust the bench height while sitting on the bench, since this can cause excessive force to be imposed on the adjustment mechanism, possibly resulting in damage to the mechanism or even injury.
- If the bench screws become loose due to extensive long-term use, tighten them periodically using the included tool.

## Saving data

### Saving and backing up your data

- Current data (see page 46) is lost when you turn off the power to the instrument. Save the data to a floppy disk (CLP-170)/ the storage memory (see page 46).

Saved data may be lost due to malfunction or incorrect operation. Save important data to a floppy disk (CLP-170).

### Backing up the floppy disk (CLP-170)

- To protect against data loss through media damage, we recommend that you save your important data onto two floppy disks.

Yamaha cannot be held responsible for damage caused by improper use or modifications to the instrument, or data that is lost or destroyed.

Always turn the power off when the instrument is not in use.

# Clavinova®



Thank you for choosing the Yamaha Clavinova CLP-170/150. In order to make the most of your Clavinova's performance potential and features, please read this Owner's Manual thoroughly, and keep it in a safe place for later reference.

## *About this Owner's Manual and Reference Booklet*

This manual consists of four main sections: "Introduction," "Basic Operation," "Detailed Settings," and "Appendix." Also, a separate "Reference Booklet" is provided.

**Introduction:** Please read this section first. In the "Application Index" section on page 10 and "Features" on page 14, you can learn how to use the Clavinova and its functions in particular situations.

**Basic Operation:** This main section explains how to use the basic functions. Refer to this section while you play the Clavinova. If you have questions or come across the words you do not know, refer to the section entitled "Questions about Operations and Functions" on page 102, or the "Index" on page 118.

**Detailed Settings:** This section explains how to make detailed settings for the Clavinova's various functions. Refer to this section as necessary.

**Appendix:** This section introduces troubleshooting, a description of preset voices, and other reference material.

**Reference Booklet:** XG Voice List, MIDI Data Format, etc.

- The models CLP-170/150 will be referred to as the CLP/Clavinova in this Owner's Manual.
- The illustrations and LCD screens as shown in this Owner's Manual are for instructional purposes only, and may appear somewhat different from those on your instrument.
- Copying of the commercially available software is strictly prohibited except for your personal use.

### **COPYRIGHT NOTICE**

This product incorporates and bundles computer programs and contents in which Yamaha owns copyrights or with respect to which it has license to use others' copyrights. Such copyrighted materials include, without limitation, all computer software, MIDI files, WAVE data and sound recordings. Any unauthorized use of such programs and contents outside of personal use is not permitted under relevant laws. Any violation of copyright has legal consequences. **DON'T MAKE, DISTRIBUTE OR USE ILLEGAL COPIES.**

### **■ Trademarks**

- Apple and Macintosh are trademarks of Apple Computer, Inc., registered in the U.S. and other countries.
- Windows is the registered trademark of Microsoft® Corporation.

All other trademarks are the property of their respective holders.

**"The Clavinova-Computer Connection,"** is a supplementary guidebook that describes, for beginners, what you can do with your Clavinova and a personal computer and how to set up a Clavinova-Computer system (the manual is not written for any specific models). The document is available as a PDF file (in English) at the following Internet address:

Clavinova Web site (English only):  
Yamaha Manual Library:

<http://www.yamahaclavinova.com/>  
<http://www2.yamaha.co.jp/manual/english/>

# Table of contents

## Introduction..... 2

### PRECAUTIONS ..... 3

About this Owner's Manual and Reference Booklet..... 5

### Table of contents ..... 6

### Application Index ..... 10

### Handling the Floppy Disk Drive (FDD) and Floppy Disk (CLP-170)..... 12

### Maintenance ..... 13

### Included Accessories ..... 13

### Features ..... 14

### Before Using the Clavinova..... 16

About the key cover ..... 16

About the music rest..... 16

About the music braces..... 16

Turning the power on..... 17

Adjusting the display contrast..... 18

Setting the volume ..... 18

Using headphones..... 18

Performing the iAFC automatic adjustment (CLP-170) ..... 18

## Basic Operation ..... 19

### Part Names ..... 20

### Listening to the Demonstration Tunes..... 22

### Listening to 50 Piano Preset Songs ..... 24

Playing the 50 piano preset songs ..... 24

Practicing a one-hand part using 50 preset songs..... 26

### Selecting and Playing Voices ..... 28

Selecting Voices..... 28

Using the pedals ..... 29

Adding variation to the sound [BRILLIANCE]/[REVERB]/[CHORUS]..... 30

To enhance the acoustic realism of the sound ...[iAFC (Instrumental Active Field Control)] (CLP-170) ..... 32

Combining two voices (Dual mode)..... 33

Splitting the keyboard range and playing two different voices (Split mode) ..... 35

Using the metronome..... 37

### Recording Your Performance..... 38

Recording a New Song..... 38

Recording to [TRACK 1]..... 38

Re-recording TRACK 1..... 40

Re-recording TRACK 1 partially..... 41

Recording to [TRACK2]..... 42

Recording to the third or more tracks [EXTRA TRACKS] ..... 43

Other recording techniques..... 43

Changing a voice or tempo after recording .....	44
Adjusting the volume balance between playback and your performance [SONG BALANCE] .....	45
Recording in Dual or Split mode .....	45
<b>Saving Recorded Songs and Handling the Files...[FILE] .....</b>	<b>46</b>
Clavinova memory .....	46
Basic file operation .....	47
Saving recorded or other songs to Clavinova Storage memory...[SaveToMemory] .....	48
Saving recorded or other songs to floppy disk...[SaveToDisk] (CLP-170).....	49
Deletes a song from the Clavinova's save memory or (CLP-170 only) from a floppy disk...[DeleteSong] .....	50
Renaming a song...[RenameSong] .....	51
Copying data from one floppy disk to another...[CopyDisk] (CLP-170).....	52
Formatting a floppy disk...[FormatDisk] (CLP-170).....	53
Automatically open a song when the disk is inserted [FloppyDiskSongAutoOpen] (CLP-170) .....	54
Changing the type of characters on screen...[CharacterCode] .....	54
<b>Playing Back Recorded Songs and Commercially-available Music Data .....</b>	<b>55</b>
Playing back a song .....	55
Turning track playback on and off.....	57
Supported song data type .....	57
<b>Connections .....</b>	<b>59</b>
Connectors .....	59
Connecting a personal computer .....	61

## **Detailed Settings ..... 67**

<b>Detailed Settings.....</b>	<b>68</b>
Parameter List .....	68
Making detailed settings .....	71
<b>Detailed settings for recording and playback [SONG SETTING] .....</b>	<b>73</b>
Correcting note timing [Quantize] .....	73
Specifying whether playback starts immediately along with the first voicing [QuickPlay] .....	74
Auditioning the channels [ChannelListen] .....	74
Deleting data from each channel [ChannelClear].....	74
Specifying the range and playing back repeatedly [FromToRepeat] .....	74
Playing back the phrase specified by the phrase number [PhraseMark] .....	75
Playing back a song repeatedly [SongRepeat] .....	75
<b>Detailed settings for the metronome METRONOME [SETTING] .....</b>	<b>76</b>
Setting the metronome time signature [TimeSignature].....	76
Setting the metronome volume level [MetronomeVolume].....	76
Selecting the metronome voice [MetronomeSound] .....	76
<b>Detailed settings for the voices [VOICE SETTING] .....</b>	<b>77</b>
Setting the octave [Octave] .....	78
Setting the volume level [Volume] .....	78
Setting the position of right and left channels [Pan] .....	78
Make fine adjustments to the pitch (only in Dual mode) [Detune] .....	78
Selecting the reverb type [ReverbType] .....	79

## Table of contents

Setting the reverb depth [ReverbSend] .....	79
Selecting the chorus type [Chorus Type].....	79
Setting the chorus depth [ChorusSend] .....	79
Setting the chorus on/off [ChorusOnOff] .....	80
Selecting the DSP type [DSP Type (DSP)] .....	80
Setting the speed of the vibraphone vibrato effect [VibeRotorSpeed].....	80
Turning the vibraphone vibrato effect on/off [VibeRotorOnOff (RotorOnOff)] .....	81
Setting the rotation speed of the rotary speaker [RotarySpeed (Rot.Speed)].....	81
Adjusting the depth of the DSP effect [DSPDepth].....	81
Adjusting the brightness of the sound [Brightness].....	81
Adjusting the resonance effect [HarmonicContent (Harmonic)] .....	81
Adjusting the low-range frequency of the equalizer [EQ LowFreq. (EQ L.Freq)] .....	82
Adjusting the low-range gain (amount of boost/cut) of the equalizer [EQ LowGain].....	82
Adjusting the high-range frequency of the equalizer [EQ HighFreq. (EQ H.Freq)] .....	82
Adjusting the high-range gain (amount of boost/cut) of the equalizer [EQ HighGain] .....	82
Setting the touch sensitivity [TouchSense].....	83
Setting the right pedal function [RPedal] .....	83
Setting the center pedal function [MPedal] .....	83
Setting the left pedal function [LPedal] .....	84
Setting the auxiliary pedal function [AuxPedal] .....	84
<b>Detailed settings for iAFC [iAFC SETTING] (CLP-170).....</b>	<b>85</b>
Selecting the iAFC type [iAFC Type] .....	85
Adjusting the iAFC depth [iAFC Depth] .....	85
Calibration (automatic adjustment) [Calibration].....	86
Restoring the default iAFC settings [iAFC Default].....	86
<b>MIDI [MIDI SETTING].....</b>	<b>87</b>
About MIDI.....	87
Setting the MIDI transmit channel [MidiOutChannel] .....	88
Setting the MIDI receive channel [MidiInChannel] .....	88
Setting Local control on/off [LocalControl].....	89
Selecting performance from the keyboard or song data for MIDI transmission [MidiOutSelect] .....	89
Selecting a type of data received via MIDI [ReceiveParameter].....	89
Selecting a type of data transmitted via MIDI [TransmitParameter] .....	89
Transmitting the initial settings on the panel [InitialSetup] .....	90
Executing voice data bulk dump [VoiceBulkDump].....	90
<b>Other settings .....</b>	<b>91</b>
Selecting a touch response [TouchResponse] .....	91
Fine tuning the pitch [Tune].....	91
Selecting a tuning curve for a piano voice [PianoTuningCurve] .....	91
Selecting a scale [Scale] .....	92
Specifying the Split Point [Split Point] .....	92
Changing the key [Transpose] .....	92
Adjusting the depth of the Soft pedal [SoftPedalDepth] .....	93
Depth of string resonance [StringResonanceDepth] .....	93
Depth of sustain sampling for the damper pedal [SustainSamplingDepth].....	93
Specify the volume of the key-off sound [KeyOffSamplingDepth] .....	93
Selecting a pedal function for vibraphone [VibraphonePedalMode] .....	93
Assign the SONG [START/STOP] function to the pedal [PedalStart/Stop] .....	94
Selecting a type of auxiliary pedal [AuxPedalType].....	94
Setting the point at which the damper pedal starts to affect the sound [HalfPedalPoint] .....	94



Pitch bend range [PitchBendRange] ..... 94  
 Switch the speaker on/off [Speaker] ..... 95  
 Selecting items saved at shutdown [MemoryBackUp] ..... 95  
 Restoring the normal (default) settings [FactorySet] ..... 95  
 Other method for restoring the normal settings ..... 95  
**Message List ..... 96**  
**Questions about Operations and Functions ..... 102**

**Appendix ..... 105**

Troubleshooting ..... 106  
 Data Compatibility ..... 107  
 Preset Voice List ..... 109  
 Voice Combination Examples (Dual and Split) ..... 111  
 CLP-150: Keyboard Stand Assembly ..... 112  
 CLP-170: Keyboard Stand Assembly ..... 115  
 Index ..... 118

# Application Index

Use this index to find reference pages that may be helpful for your application and situation.

---

## Listening

---

- Listening to demo songs.....“Listening to the Demonstration Tunes” on page 22  
“Playing the 50 piano preset songs” on page 24
- Listening to demo songs with different voices .....“Listening to the Demonstration Tunes” on page 22
- Listening to songs from “50 greats for the Piano” .....“Playing the 50 piano preset songs” on page 24
- Listening to my recorded performance .....“Recording to [TRACK 1]” on page 38  
“Playing back a song” on page 55
- Listening to songs in a floppy disk (CLP-170) .....“Playing back a song” on page 55

---

## Playing

---

- Using three pedals.....“Using the pedals” on page 29
- Playing an accompaniment that matches pitch .....“Changing the key [Transpose]” on page 92

---

## Changing tonal color

---

- Viewing the list of voices.....“Preset Voice List” on page 109
- Simulating a concert hall..... “[REVERB]” on page 31
- Combining two voices .....“Combining two voices (Dual mode)” on page 33
- Playing different sounds with left and right hands  
.....“Splitting the keyboard range and playing two different voices (Split mode)” on page 35
- Making a voice brighter and sharper, or softer and smoother ..... “[BRILLIANCE]” on page 30
- Adding spread to the sound ..... “[CHORUS]” on page 31
- Making the sound three-dimensional  
..... “[iAFC (Instrumental Active Field Control)] (CLP-170)” on page 32

---

## Practicing

---

- Muting the right- or left-hand part .....“Practicing a one-hand part using 50 preset songs” on page 26
- Practicing with an accurate and steady tempo.....“Using the metronome” on page 37
- Practicing using your recorded song .....“Recording Your Performance” on page 38  
“Turning track playback on and off” on page 57

---

## Recording

---

- Recording your performance .....“Recording Your Performance” on page 38
- Saving recorded songs to floppy disks (CLP-170) or memory  
.....“Saving Recorded Songs and Handling the Files...[FILE]” on page 46

---

## **Settings**

---

- Making detailed settings for recording and playback  
..... “Detailed settings for recording and playback [SONG SETTING]” on page 73
- Making detailed settings for the metronome  
..... “Detailed settings for the metronome METRONOME [SETTING]” on page 76
- Making detailed settings for the voices  
..... “Detailed settings for the voices [VOICE SETTING]” on page 77
- Making detailed settings for MIDI ..... “MIDI [MIDI SETTING]” on page 87
- Making detailed settings for the Clavinova ..... “Other settings” on page 91

---

## **Connecting the Clavinova to other devices**

---

- What is MIDI?..... “About MIDI” on page 87
- Recording your performance “AUX OUT [R][L] Pin jacks (LEVEL FIXED), [R][L/L+R] Phone jacks” on page 60
- Raising the volume .. “AUX OUT [R][L] Pin jacks (LEVEL FIXED), [R][L/L+R] Phone jacks” on page 60
- Outputting other instruments’ sound from the Clavinova ..... “AUX IN [R], [L/L+R] jacks” on page 60
- Connecting a computer..... “Connecting a personal computer” on page 61

---

## **Assembling**

---

- Assemble/disassemble the Clavinova..... “CLP-150: Keyboard Stand Assembly” on page 112  
..... “CLP-170: Keyboard Stand Assembly” on page 115

---

## **Quick solution**

---

- What the Clavinova offers..... “Application Index” on page 10  
..... “Features” on page 14
- Returning to the main screen..... “EXIT button” on page 20
- Resetting the Clavinova to the default setting  
..... “Restoring the normal (default) settings [FactorySet]” on page 95
- Meaning of the messages..... “Message List” on page 96
- If you have questions about operations and functions  
..... “Questions about Operations and Functions” on page 102
- Troubleshooting..... “Troubleshooting” on page 106

# Handling the Floppy Disk Drive(FDD) and Floppy Disk (CLP-170)

## Precautions

Be sure to handle floppy disks and treat the disk drive with care. Follow the important precautions below.

## Compatible Disk Type

3.5" 2DD and 2HD type floppy disks can be used.

## Inserting/Ejecting Floppy Disks

To insert a floppy disk into the disk drive:

Hold the disk so that the label of the disk is facing upward and the sliding shutter is facing forward, towards the disk slot. Carefully insert the disk into the slot, slowly pushing it all the way in until it clicks into place and the eject button pops out.

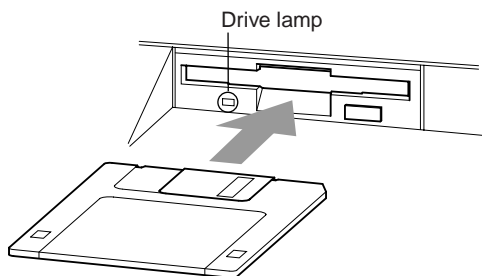

## To eject a floppy disk:

Before ejecting the disk, be sure to confirm that the floppy disk drive is stopped. If the disk drive is operating (during the [SaveToDisk] (P53), [DeleteSong] (P53), [RenameSong] (P54), [CopyDisk] (P55), or [FormatDisk] (P56) operation), the Clavinova displays [Executing].

Never attempt to remove the disk or turn the power off when the disk drive is operating. Doing so can damage the disk and possibly the disk drive.

Press the eject button slowly as far as it will go; the disk will automatically pop out. When the disk is fully ejected, carefully remove it by hand.

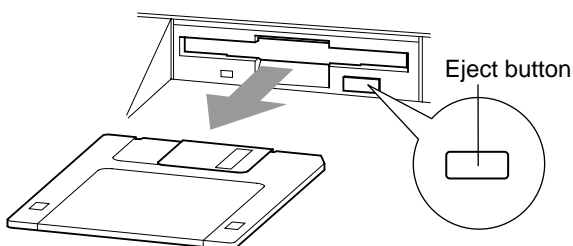

If the eject button is pressed too quickly, or if it is not pressed in as far as it will go, the disk may not eject properly. The eject button may become stuck in a half-pressed position with the disk extending from the drive slot by only a few millimeters. If this happens, do not attempt to pull out the partially ejected disk, since using force in this situation can damage the disk drive mechanism or the floppy disk. To remove a partially ejected disk, try pressing the eject button once again, or push the disk back into the slot and then repeat the eject procedure.

Be sure to remove the floppy disk from the disk drive before turning off the power. A floppy disk left in the drive for extended periods can easily pick up dust and dirt that can cause data read and write errors.

## Cleaning the Disk Drive Read/Write Head

- Clean the read/write head regularly. This instrument employs a precision magnetic read/write head which, after an extended period of use, will pick up a layer of magnetic particles from the disks used that will eventually cause read and write errors.
- To maintain the disk drive in optimum working order Yamaha recommends that you use a commercially-available dry-type head cleaning disk to clean the head about once a month. Ask your Yamaha dealer about the availability of proper head-cleaning disks.
- Never insert anything but floppy disks into the disk drive. Other objects may cause damage to the disk drive or floppy disks.

## About the Floppy Disks

- **To handle floppy disks with care:**
- Do not place heavy objects on a disk or bend or apply pressure to the disk in any way. Always keep floppy disks in their protective cases when they are not in use.
- Do not expose the disk to direct sunlight, extremely high or low temperatures, or excessive humidity, dust or liquids.
- Do not open the sliding shutter and touch the exposed surface of the floppy disk inside.
- Do not expose the disk to magnetic fields, such as those produced by televisions, speakers, motors, etc., since magnetic fields can partially or completely erase data on the disk, rendering it unreadable.
- Never use a floppy disk with a deformed shutter or housing.
- Do not attach anything other than the provided labels to a floppy disk. Also make sure that labels are attached in the proper location.

- **To protect your data (Write-protect Tab):**
- To prevent accidental erasure of important data, slide the disk's write-protect tab to the "protect" position (tab open).

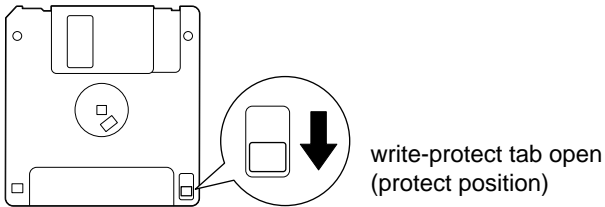

- **Data backup**
- For maximum data security Yamaha recommends that you keep two copies of important data on separate floppy disks. This gives you a backup if one disk is lost or damaged. To make a backup disk use the Copy Disk function on page 52.

# Maintenance

Clean the instrument using a dry or slightly damp soft cloth (wring well).

### ⚠ CAUTION

Do not use benzene, thinner, detergent, or chemically-treated cloth for cleaning. Do not place vinyl, plastic or rubber products on the instrument.

Otherwise, the panel or keys may become discolored or degraded.

### ⚠ CAUTION

Before using the Clavinova, be sure to read "Precautions" on pages 3-4.

## Tuning

Unlike an acoustic piano, the Clavinova does not need to be tuned. It always stays perfectly in tune.

## Transporting

If you move to another location, you can transport the Clavinova along with your other belongings. You can move the unit as it is (assembled) or you can disassemble the unit.

Transport the keyboard horizontally. Do not lean it up against a wall or stand it up on its side. Do not subject the instrument to excessive vibration or shock.

### TIP

The CLP-170 features an iAFC (Instrumental Active Field Control) effect. This produces sound from the speaker located on the rear of the Clavinova, enhancing the reverberation and spaciousness of the sound.

In order to take full advantage of iAFC, we recommend that you do the following.

- Place the Clavinova so that its rear panel is at least 10 cm away from the wall.
- After you move the Clavinova to a different location, perform the automatic adjustment. (page 86)

# Included Accessories

"50 greats for the Piano" Score Collection

Owner's Manual

Reference Booklet

Recording disk (CLP-170)

Save your recorded performance to this disk. (page 49)

Bench

(included or optional depending on locale)

# Features

The Yamaha CLP-170/150 Clavinova features rich sounds produced by Yamaha’s proprietary “**AWM dynamic stereo sampling**” tone generator system, a “**Graded Hammer**” keyboard (CLP-150) that varies the key weight according to the key range, and a “**GH3**” keyboard (CLP-170) that enhances the graded hammer keyboard by allowing you to play a note to be played repeatedly without pressing the pedal, giving these electronic pianos a “playing-feel” that is very close to the keyboard of a genuine grand piano. The CLP-170/150 GrandPiano1 voice features 3 velocity-switched samples (**Dynamic Sampling**), “**String Resonance**” (page 93) that recreates resonance of piano strings, special “**Sustain Sampling**” (page 93) that samples the unique resonance of an acoustic grand piano’s soundboard and strings when the damper pedal is pressed, and “**Key-off Samples**” that add the subtle sound produced when the keys are released. The CLP-170/150 comes much closer to the sound of a true acoustic piano.

The illustration shows the CLP-170

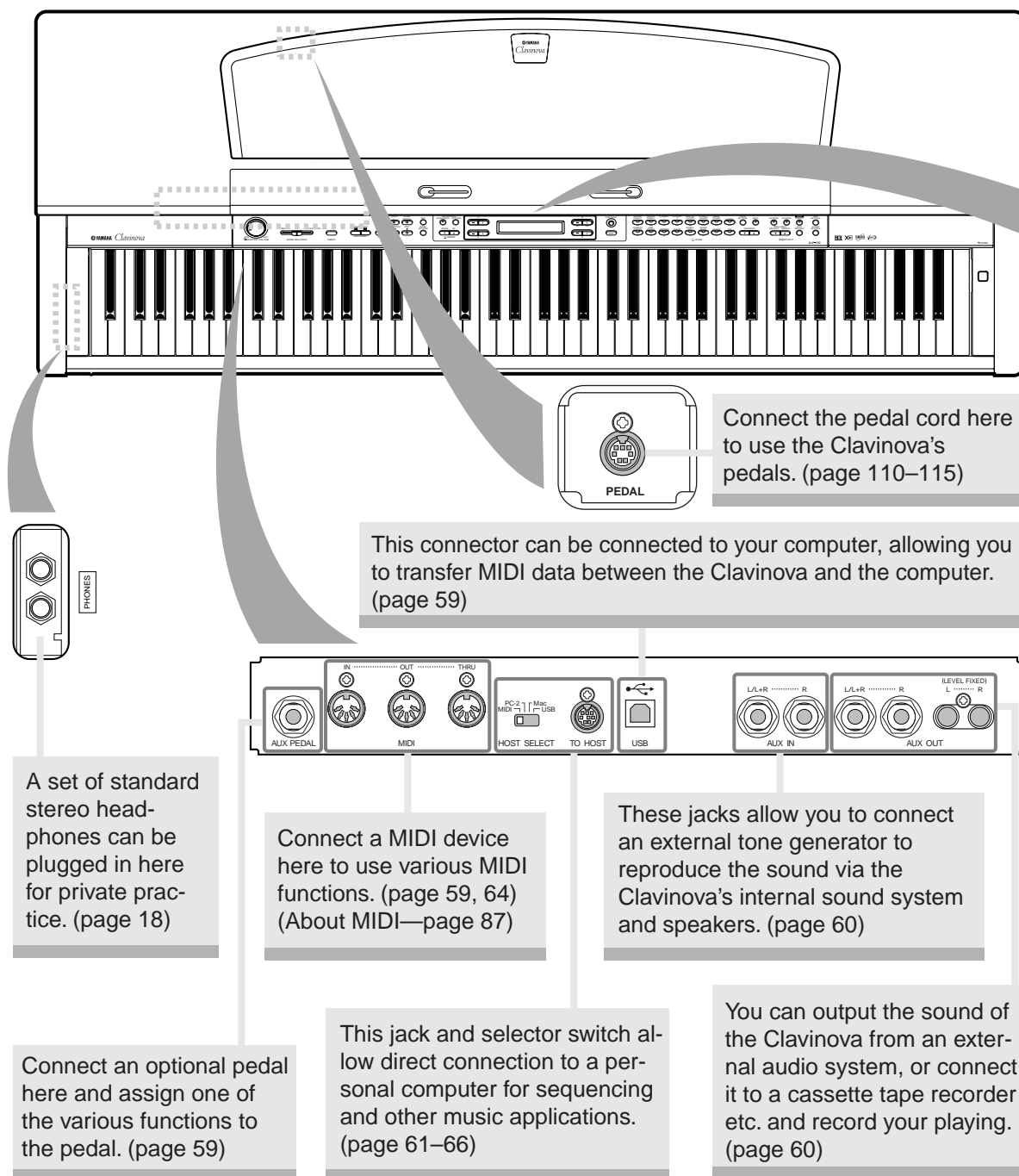

**The Clavinova includes 50 preset songs.**

This section enables you to listen to these songs, practice using a convenient practice function, play back Clavinova music data (sold in music stores), and record and play back your performance. (page 24, 38, 55)

**[FILE]**

Save recorded songs and manage song files. (page 46)

**[MIDI SETTING]**

Make detailed MIDI settings, such as MIDI receive/transmit channels. (page 87)

**[METRONOME]**

Use the metronome functions. (page 37)

**[REVERB] / [CHORUS]**

Add reverb (reverberation) and spread (chorus) to the sound. (page 31)

**Voice group buttons**

You can choose from sixteen groups of voices, including grand piano. You can also combine two sounds and use them together. (page 28)

**[MASTER VOLUME]**

Adjust the volume level using this dial. (page 18)

**[DEMO]**

Demonstration playback is available for each voice. (page 22)

**[CONTRAST]**

Adjust the brightness of the display using this control. (page 18)

**[SPLIT]**

You can play different voices on the left- and right-hand sections of the keyboard. (page 35)

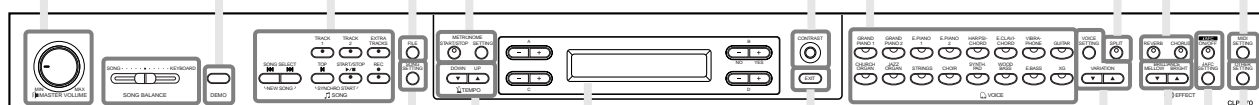

**[SONG SETTING]**

Make detailed settings for song recording and playback. (page 73)

The display allows accurate control and operation. (page 21)

**[EXIT]**

The screen returns to its main display when you press this button. (page 21)

**[SONG BALANCE]**

This lets you adjust the volume balance between the song playback and the sound you are playing on the keyboard. (page 45)

**[VOICE SETTING] / [VARIATION]**

You can make detailed settings for tone and effects. (page 77)

**TEMPO [DOWN] [UP]**

You can change the song tempo (speed). (page 25, 37, 39, 55)

**BRILLIANCE [MELLOW] [BRIGHT]**

Adjust the brightness of the tone using these buttons. (page 30)

**[iAFC ON/OFF] (CLP-170)**

This enhances the acoustic realism of the sound produced from the Clavinova, similar to the sound of an acoustic instrument. (page 32)

**[iAFC SETTING] (CLP-170)**

You can select the iAFC type and make other detailed settings for iAFC. (page 85)

**TIP**

In order to obtain optimal results from iAFC (CLP-170), we recommend that you do the following:

- Position the Clavinova so that its rear panel is at least 10 cm away from the wall.
- Perform the automatic adjustment after you turn on the power of the Clavinova for the first time, and after each time you re-locate the Clavinova.

**[OTHER SETTING]**

This lets you make detailed settings, such as adjusting the keyboard touch or making fine adjustments to the pitch. (page 91)

# Before Using the Clavinova

## About the key cover

### To open the key cover:

Lift the cover slightly, then push and slide it open.

### To close the key cover:

Slide the cover toward you and gently lower the cover over the keys.

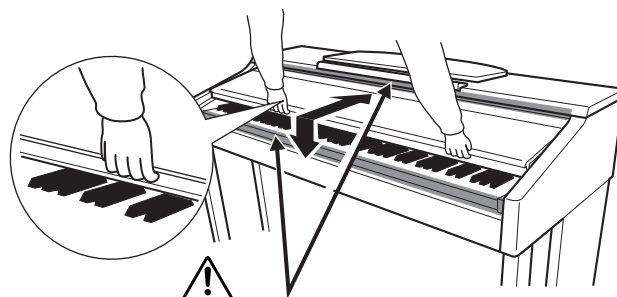

Be careful to avoid catching your fingers when opening or closing the cover.

### ⚠ CAUTION

Hold the cover with both hands when opening or closing it. Do not release it until it is fully opened or closed. Be careful to avoid catching fingers (yours or others, especially children's) between the cover and the unit.

Do not place objects such as a piece of metal or paper on top of the key cover. Small objects placed on the key cover may fall inside the unit when the cover is opened and may be nearly impossible to remove. This could cause electric shock, short circuit, fire or other serious damage to the instrument.

## About the music rest

### To raise the music rest:

1. Pull the music rest up and toward yourself as far as it will go.
2. Flip down the two metal supports at the left and right on the rear of the music rest.
3. Lower the music rest so that it rests on the metal supports.

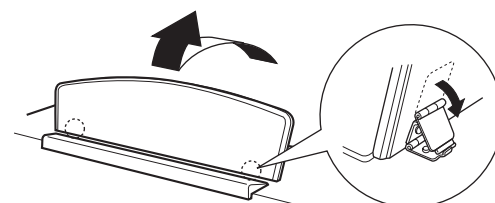

### To lower the music rest:

1. Pull the music rest toward yourself as far as it will go.
2. Raise the two metal supports (at the rear of the music rest).
3. Gently lower the music rest backward until it is all the way down.

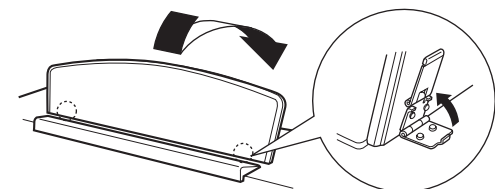

### ⚠ CAUTION

Do not try to use the music rest in a half-raised position. When lowering the music rest, do not release your hands from the music rest until it is all the way down.

## About the music braces

These braces are for holding the pages of music books in place.

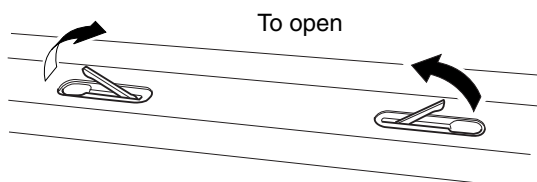

To open

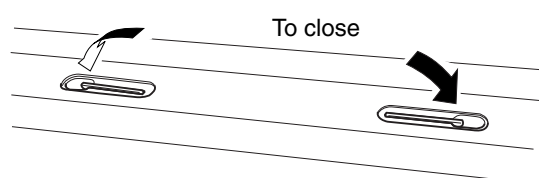

To close



## Turning the power on

### 1. Connect the power cable.

First insert the plug of the power cable into the AC connector on the Clavinova, then plug the other end of the cable into the proper AC outlet on the wall.

In some areas a plug adaptor may be provided to match the pin configuration of the AC wall outlets in your area.

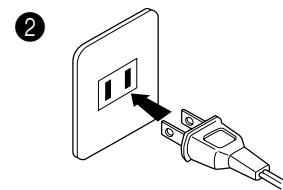
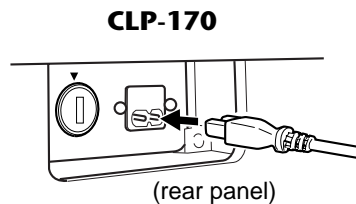
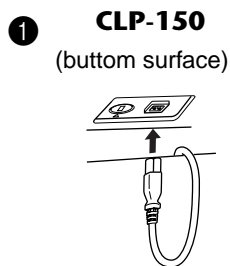

(The shape of plug differs depending on locale.)

#### **⚠ WARNING!**

Make sure your CLP-170/150 is rated for the AC voltage supplied in the area in which it is to be used (voltage rating appears on the name plate on the bottom panel). In some areas, a voltage selector may be provided on the bottom panel of the main keyboard unit near the power cord. Make sure that the voltage selector is set for the voltage in your area. Connecting the unit to the wrong AC supply can cause serious damage to the internal circuitry and may even pose a shock hazard!

Use only the AC power cord supplied with the CLP-170/150. If the supplied cord is lost or damaged and needs to be replaced, contact your Yamaha dealer. The use of an inappropriate replacement can pose a fire and shock hazard!

The type of AC power cord provided with the CLP-170/150 may be different depending on the country in which it is purchased. (In some areas a plug adaptor may be provided to match the pin configuration of the AC wall outlets in your area.) Do NOT modify the plug provided with the CLP-170/150. If the plug will not fit the outlet, have a proper outlet installed by a qualified electrician.

### 2. Turn on the power to the Clavinova.

Press the [POWER] switch located on the right of the keyboard to turn the power on.

- The screen located in the center of the front panel and the power indicator located below the left end of the keyboard lights up.

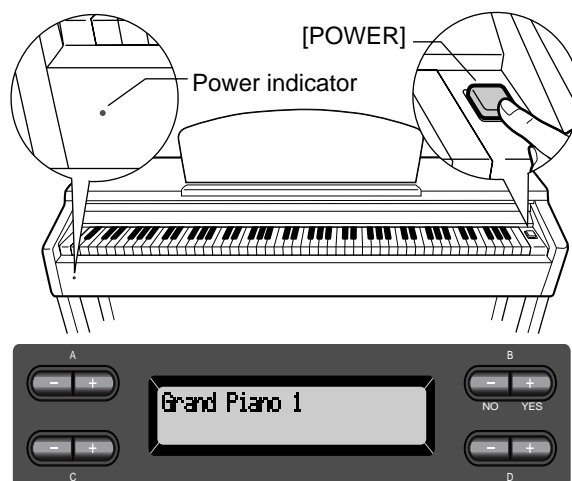

When you turn on the power to the Clavinova, a voice name appears on the screen.

Press the [POWER] switch again to turn off the power to the Clavinova.

- The screen and the power indicator turn off.

#### **TIP**

##### **Power indicator**

If you close the key cover without turning the power off, the power indicator remains lit, indicating that the power is still on.

## Adjusting the display contrast

You can adjust the contrast of the display by turning the [CONTRAST] knob located to the right of the LCD.



Use this knob.

### TERMINOLOGY

**CONTRAST:** difference between brightness and darkness

## Setting the volume

To adjust the volume, use the [MASTER VOLUME] located at the left of the panel. Play the keyboard to actually produce sound while you adjust the volume.

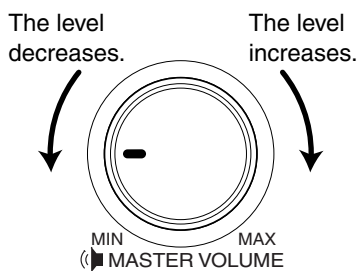

**CAUTION**  
Do not use the Clavinova at a high volume level for a long period of time, or your hearing may be damaged.

### TERMINOLOGY

**MASTER VOLUME:** The volume level of the entire keyboard sound

### TIP

You can also adjust the [PHONES] output level, the AUX IN input level and the AUX OUT [L/L+R][R] output level using the [MASTER VOLUME] dial.

## Using headphones

Connect a pair of headphones to one of the [PHONES] jacks. When the headphones are plugged into either of the [PHONES] jacks, the internal speaker system is automatically shut off. Two [PHONES] jacks are provided. Two sets of standard stereo headphones can be plugged in. (If you are using only one pair of headphones, you can plug them into either of these jacks.)

**CAUTION**  
Do not use headphones at a high volume for an extended period of time. Doing so may cause hearing loss.

### Using the Headphone Hanger

A headphone hanger is included in the CLP-170/150 package so that you can hang the headphones on the Clavinova. Install the headphone hanger using included two screws (4 × 10mm) as shown in the figure.

**CAUTION**  
Do not hang anything other than the headphones on the hanger. Otherwise, the Clavinova or the hanger may be damaged.

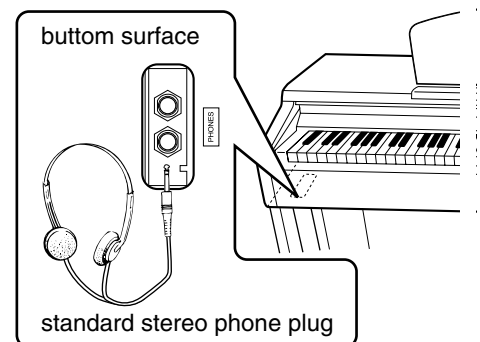

### TIP

**Optional headphones**  
HPE-160 Yamaha headphones.

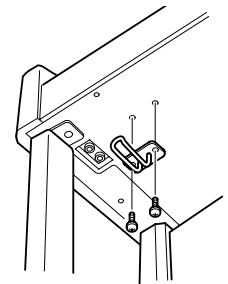

## Performing the iAFC automatic adjustment (CLP-170)

The CLP-170 features an iAFC (Instrumental Active Field Control) effect. This produces sound from the speaker located on the rear of the Clavinova, enhancing the reverberation and spaciousness of the sound. In order to take full advantage of iAFC, perform the automatic adjustment. (page 86)

# *Basic Operation*

# Part Names

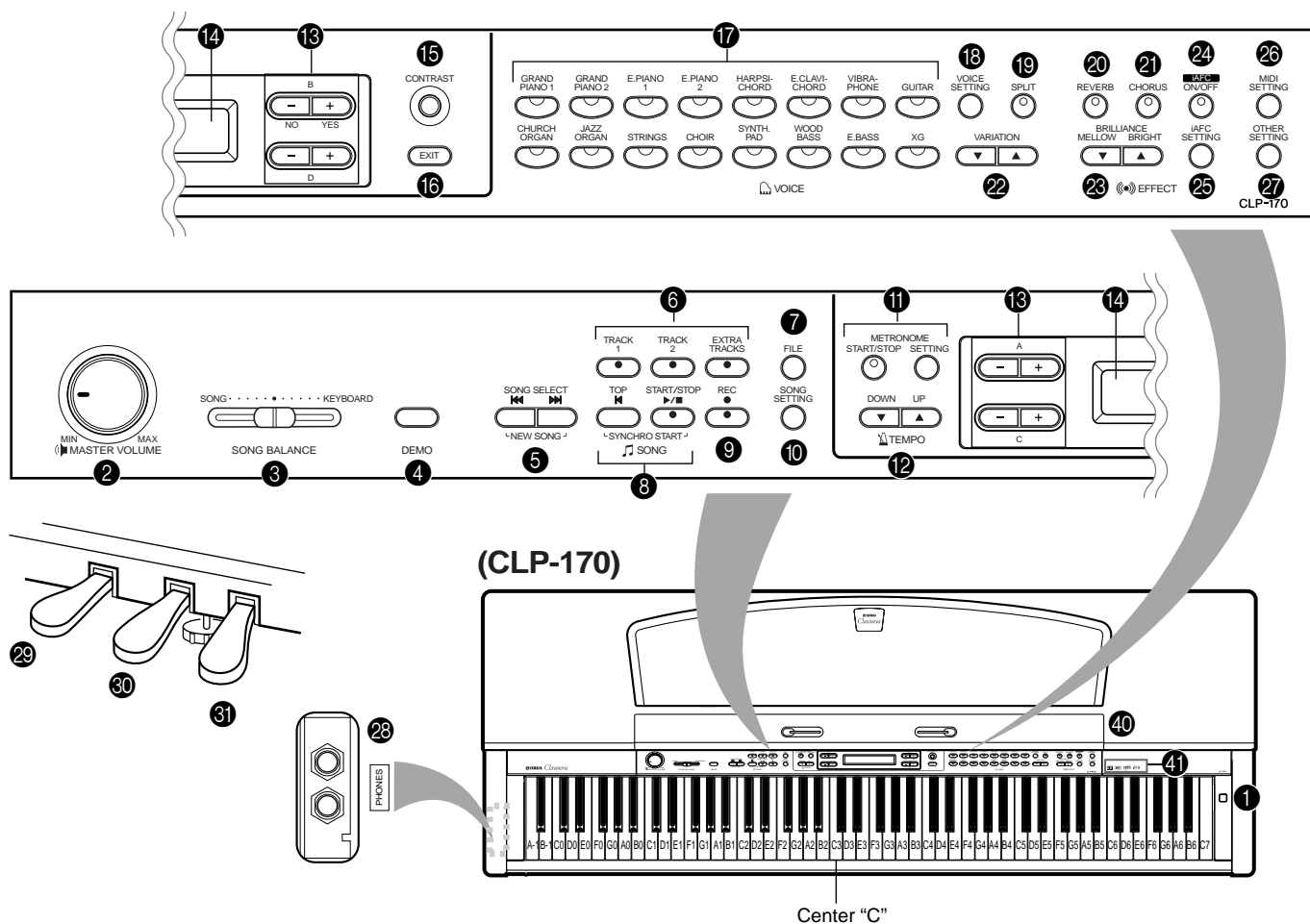

## Top panel

- |  |                 |                                     |     |
|--|-----------------|-------------------------------------|-----|
| ① [POWER].....   | P17             | ⑮ [CONTRAST] knob.....              | P18 |
| ② [MASTER VOLUME].....   | P18             | ⑯ [EXIT].....                       | P21 |
| ③ SONG BALANCE.....  | P45             | ⑰ Voice group buttons .....         | P28 |
| ④ [DEMO] .....   | P22             | ⑱ [VOICE SETTING] .....             | P77 |
| ⑤ SONG SELECT [◀◀] [▶▶].....   | P24, 38, 55     | ⑲ [SPLIT] .....                     | P35 |
| ⑥ [TRACK1] [TRACK2] /<br>[EXTRA TRACKS] .....                              | P26, 38–43, 57  | ⑳ [REVERB].....                     | P31 |
| ⑦ [FILE] .....   | P46             | ㉑ [CHORUS].....                     | P31 |
| ⑧ [TOP] / SONG [START/STOP]<br>.....                                       | P24, 39, 56     | ㉒ VARIATION [▼] [▲] .....           | P28 |
| ⑨ [REC].....   | P37             | ㉓ BRILLIANCE [MELLOW] [BRIGHT]..... | P30 |
| ⑩ [SONG SETTING] .....   | P73             | ㉔ iAFC [ON] / [OFF] (CLP-170).....  | P32 |
| ⑪ METRONOME [START/STOP] /<br>[SETTING].....                               | P37, 76         | ㉕ [iAFC SETTING] (CLP-170) .....    | P85 |
| ⑫ TEMPO [DOWN] [UP] .....  | P25, 37, 39, 56 | ㉖ [MIDI SETTING].....               | P87 |
| ⑬ LCD buttons A [-] [+] / B [- (NO)] [+ (YES)] /<br>C [-] [+] / D [-] [+]. | P21             | ㉗ [OTHER SETTING] .....             | P91 |
| ⑭ LCD screen .....   | P21             | ㉘ [PHONES] .....                    | P18 |
|  |                 | ㉙ Soft pedal .....                  | P29 |
|  |                 | ㉚ Sostenuto pedal .....             | P29 |
|  |                 | ㉛ Damper pedal .....                | P29 |

**Connectors**

- 32 [AUX PEDAL] ..... P59
- 33 MIDI [IN] [OUT] [THRU] ..... P59
- 34 HOST SELECT ..... P59
- 35 [TO HOST] ..... P59
- 36 [USB] ..... P59
- 37 AUX IN ..... P60
- 38 AUX OUT ..... P60

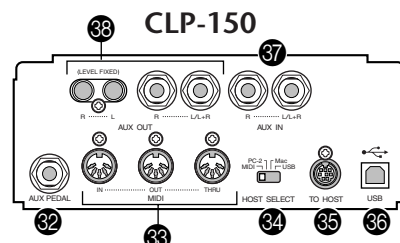
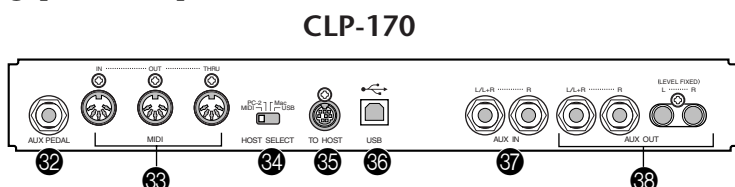

- 39 [PEDAL] ..... P113, 116
- 40 Floppy disk drive (CLP-170) ..... P12
- 41 Panel logos



**GM System Level 1**

“GM System Level 1” is an addition to the MIDI standard which guarantees that any data conforming to the standard will play accurately on any GM-compatible tone generator or synthesizer from any manufacturer.



**XG Format**

XG is a new Yamaha MIDI specification which significantly expands and improves on the “GM System Level 1” standard with greater voice handling capacity, expressive control, and effect capability while retaining full compatibility with GM.



**DOC (Disk Orchestra Collection) (CLP-170)**

This is a sound map format supported by Clavinovas and many other Yamaha MIDI instruments. Tone generators and music data compatible with this format carry the DOC logo.



**iAFC (Instrumental Active Field Control) (CLP-170)**

This is functionality that uses a multi-channel speaker system to generate three-dimensional acoustical effects from musical instruments.

**13 LCD buttons**

**14 LCD**

Use the LCD button A, B, C, or D to select the contents displayed on the LCD. Check the screen located in the center of the top panel after every operation. A voice name appears on the screen when you turn on the power to the unit.



**16 [EXIT] button**

When you press this button, the unit returns to the default screen (the screen that indicates a voice name(s) and is displayed when the power is turned on).

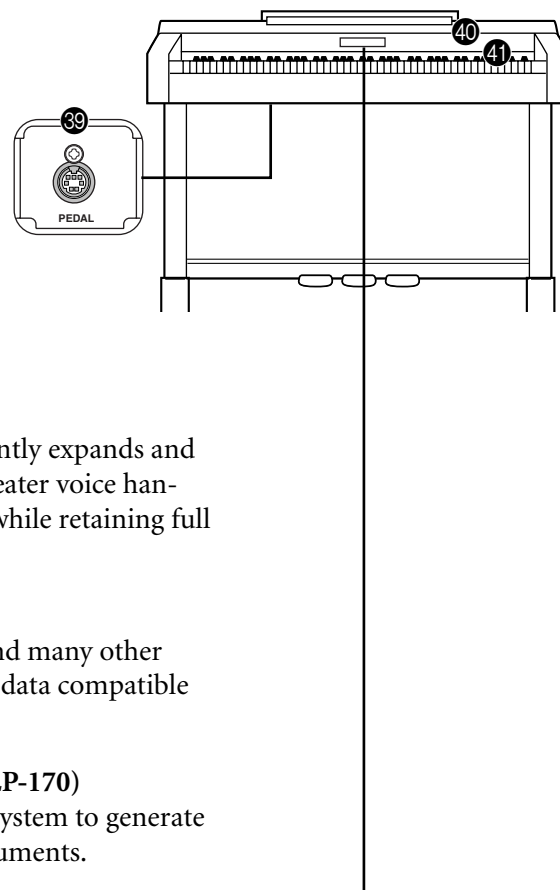

# Listening to the Demonstration Tunes

For each voice group, the Clavinova contains one demo song that shows off the character of the voices. This section explains how to listen to the demo songs for the voice groups listed below.

## Demonstration tunes

Voice group	Tunes	Composer
GRAND PIANO1	Consolation No.3	F.Liszt
HARPSICHORD	Gavotte	J.S.Bach

The demonstration pieces listed above are short rearranged excerpts the original compositions.

All other songs are original (©2002 Yamaha Corporation).



## Procedure

- Engage the demo mode.  
Press the [DEMO] button to engage the demo mode.

The indicators of the voice group buttons will blink in succession.



### TERMINOLOGY

#### Mode:

A mode is a status under which you can execute a certain function. In demo mode, you can play back demonstration tunes.

- 2. Select a tune and start playback.**  
*Press the voice group button for the demo song that you want to hear.*

The indicator of the voice group button you pressed will light, and the demo song will begin playing. Subsequently, the demo songs will play back consecutively from the upper left voice group button until you stop the playback.

- 3. Stop the playback.**  
*Press the button of the voice group being played or the SONG [START/STOP] button.*

- 4. Exit from demo mode.**  
*Press the [DEMO] or [EXIT] button to exit from demo mode.*

**NOTE**  
 To adjust the volume level of the demo songs, use the [MASTER VOLUME] dial.

**TIP**  
 To adjust the volume balance between the song playback and the sound you are playing on the keyboard, use the [SONG BALANCE] slider (page 45) .

By holding down [DEMO] and pressing A[-][+] to get the [Piano-Demo] display, you can hear the piano demo / iAFC demo (CLP-170). The piano demo lets you compare the result of enabling/disabling each sampling technology.

The iAFC demo (CLP-170) lets you compare three iAFC types. The demo songs are assigned to the sound buttons as follows.

GRAND PIANO1 .....	Stereo Piano (stereo sampling)
GRAND PIANO2 .....	Mono Piano (mono sampling)
E.PIANO1 .....	mezzo piano (dynamic sampling, mezzopiano)
E.PIANO2 .....	mezzo forte (dynamic sampling, mezzoforte)
HARPSICHORD .....	forte (dynamic sampling, forte)
E.CLAVICHORD .....	with Sustain (with sustain sampling)
VIBRAPHONE .....	no Sustain (without sustain sampling)
GIUITAR .....	with KeyOff (with key-off sampling)
CHURCH ORGAN .....	no KeyOff (without key-off sampling)
JAZZ ORGAN .....	with StringRes (with string resonance)
STRINGS .....	no StringRes (without string resonance)
GHOIR (CLP-170) .....	with iAFC SEE(iAFC spatial ensemble effect)
SYNTH.PAD (CLP-170) .....	with iAFC NSB (iAFC natural soundboard)
WOOD BASS (CLP-170) .....	with iAFC DDE (iAFC dynamic damper effect)

# Listening to 50 Piano Preset Songs

The Clavinova provides performance data of 50 piano songs. You can just listen to these songs (page 24) or use them for practice (page 26). You can also refer to the included “50 greats for the Piano” that contains the scores for 50 piano preset songs.

## Playing the 50 piano preset songs

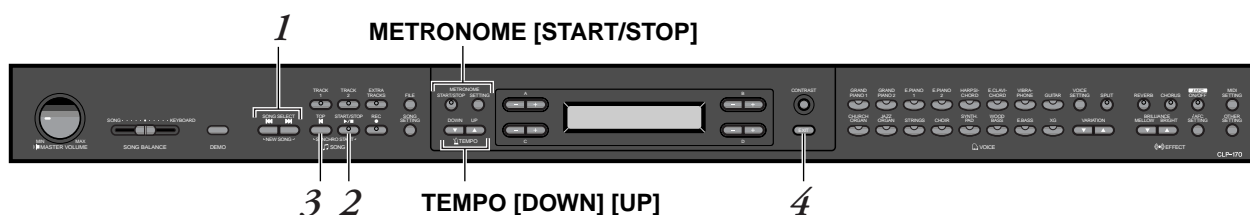

### Procedure

1. Select a song.  
Press one of the [SONG SELECT] buttons repeatedly to select the desired piano song from P-001 to P-050.

Song select screen



The song number appears on the display.

2. Play a preset song.  
Press the SONG [START/STOP] button to start playback.

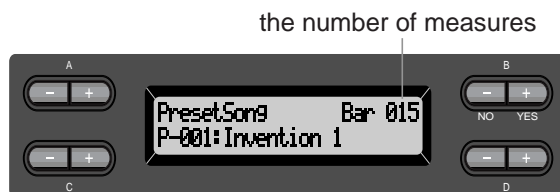

### TERMINOLOGY

#### Song:

On the Clavinova, performance data is called a “Song.” This includes demonstration tunes and piano preset tunes.

### TIP

- You can also use the C [-]/[+] buttons to select a song after pressing the [SONG SELECT] button.
- [P-000: NewSong] is a blank song provided for you to record your performance. (See page 38.)
- Use the SongRepeat parameter in the “SONG SETTING” menu to select repeat playback of all songs or repeat playback of a single song. (See page 75.)

### TIP

You can play the keyboard along with the preset song playback. You can change the voice playing on the keyboard.



---

## Adjusting the tempo

---

You can use the TEMPO [DOWN]/[UP] buttons to adjust the playback tempo as required. The default tempo (the song's original tempo) is set when you press the [DOWN] and [UP] buttons simultaneously.

Press either of the SONG SELECT [◀◀]/[▶▶] buttons to return to the song select screen.

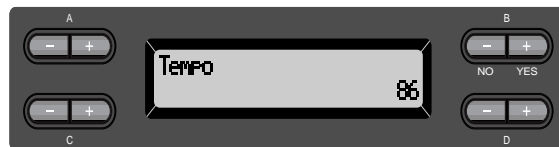

### 3. Stop the song playback.

When playback is complete, it automatically stops and the Clavinova locates the top of the song. To stop playback in the middle of a song, press the [TOP] button. You can also pause playback by pressing the SONG [START/STOP] button. Playback stops when you press the button.

---

## Fast forward and rewind

---

You can perform the following operations in the song select screen:

- Use the B [-]/[+] buttons to move back and forth (rewind and fast forward) through the song while the song is played or stopped.
- Press the SONG SELECT [◀◀] or the C [-] button during playback to restart playback from the top of the song.
- Press the SONG SELECT [▶▶] or the C [+] button during playback to start playback from the next song.
- Press the SONG SELECT [◀◀] or the C [-] button while playback is stopped in the middle of the song to locate the top of the song.

### 4. Return to the default screen.

Press the [EXIT] button.

#### TIP

You can also use the D[-]/[+] buttons to change the tempo.

#### NOTE

##### Resetting the tempo

Whenever you select a new preset song, the tempo is automatically reset to the song's original value.

#### TIP

If you have selected a disc song (CLP-170) and there is a folder before the song, the folder will appear on the display when you press the SONG SELECT [◀◀] [▶▶] buttons or C [-]/[+] buttons during song playback.

#### TERMINOLOGY

##### Default screen:

The default screen is a voice select screen (page 28) that appears when you turn on the power to the Clavinova.

## Practicing a one-hand part using 50 preset songs

The 50 preset songs have separate left- and right-hand parts on individual tracks. You can turn the left- and right-hand parts on or off as required so you can practice the corresponding part (the part that is turned off) on the keyboard. The right-hand part is played by [TRACK 1] and the left-hand part is played by [TRACK 2].

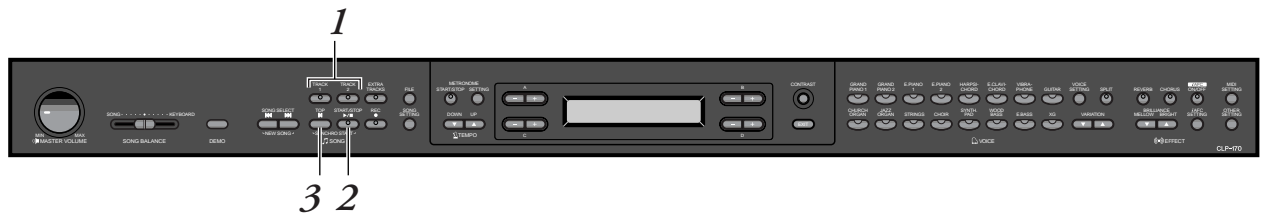

### procedure

1. Turn off the playback part you wish to practice.  
After you select a song to practice, press the [TRACK1] or [TRACK2] button to turn off the corresponding part.

When you first select a song, both [TRACK1] and [TRACK2] indicators light up, indicating that you can play back both parts. When you press one of the buttons to turn off playback, the corresponding button indicator turns off and the corresponding part playback is muted. Pressing the buttons repeatedly toggles between playback on and off.

2. Start playback and playing.  
Press the SONG [START/STOP] button to start playback.  
Play the part you just turned off.

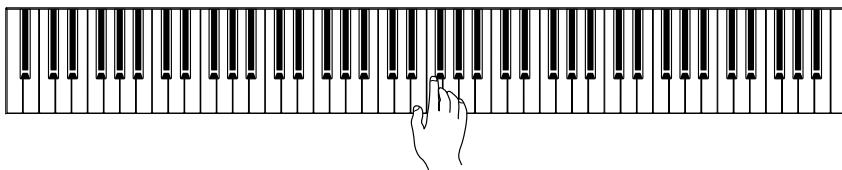

#### Starting playback automatically as you start playing the keyboard (Synchro Start)

You can cause playback to begin when you play the keyboard (Synchro Start).

Hold down [TOP] and press SONG [START/STOP]. The SONG [START/STOP] indicator will blink, and the Clavinova will wait for Synchro Start.

Now when you play the keyboard, playback will begin at the same moment.

If you press [TOP] while waiting, Synchro Start will be cancelled.

#### TIP

You can turn parts on or off, even during playback.

#### TERMINOLOGY

##### Synchro:

Synchronous; occurring at the same time

### 3. Stop playback.

When playback is complete, it automatically stops and the Clavinova locates the top of the song. If you wish to stop playback in the middle of a song, press the [TOP] button. You can also pause playback by pressing the SONG [START/STOP] button. Playback stops when you press the button.

*You can also assign a phrase in a song to repeatedly practice that part. Refer to the [FromToRepeat] option in the “SONG SETTING” menu on page 74.*

#### **TIP**

#### **Resetting the part playback**

Both parts are automatically turned ON whenever you select a new song.

# Selecting and Playing Voices

## Selecting Voices

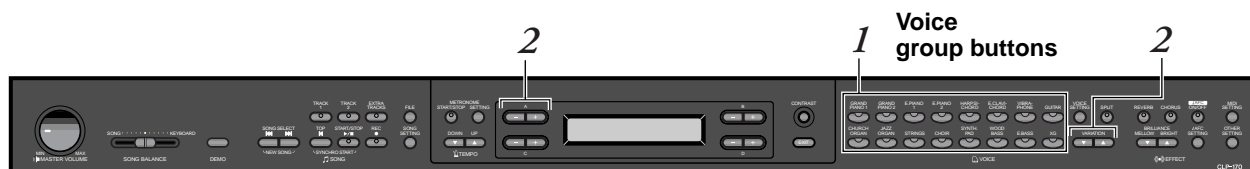

### Procedure

1. Select a voice group.  
Press a voice group button.
2. Select a voice.  
Use VARIATION [▼][▲] or A [-][+] to select a voice.

### If you select XG

If you select XG, you can select the XG voice group first, then select the desired voice.

- 2-1. Simultaneously press the [-][+] screen buttons located beside the XG voice name display, to access a screen where you can select XG voices.
- 2-2. Use A [-][+] to select the voice group.
- 2-3. Use C [-][+] to select the desired voice.

Voice group	Voice name	Voice group	Voice name
GRANDPIANO1	GrandPiano1	CHURCHORGAN	PipeOrganPrincipal
	MellowPiano		PipeOrganTutti
	RockPiano		PipeOrganFlute1
	HonkyTonkPiano		PipeOrganFlute2
GRANDPIANO2	GrandPiano2	JAZZORGAN	JazzOrgan
	BrightPiano		RotaryOrgan
E.PIANO1	E.Piano1		STRINGS
	SynthPiano	Strings	
E.PIANO2	E.Piano2	CHOIR	SynthStrings
	Vintage E.Piano		SlowStrings
HARPSICHORD	Harpsichord8'	CHOIR	Choir
	Harpsichord8'+4'		SlowChoir
E.CLAVICHORD	E.Clavichord	SYNTH.PAD	Scat
	Wah Clavi.		SynthPad1
VIBRAPHONE	Vibraphone	WOOD BASS	SynthPad2
	Marimba		WoodBass
	Celesta	Bass&Cymbal	
GUITAR	NylonGuitar	E.BASS	ElectricBass
	SteelGuitar		FretlessBass
		XG	XGVoice

- For details on XG voices, refer to "XG voice list" (the separate data list booklet).

### TERMINOLOGY

#### Voice

On the Clavinova, a voice means "tone" or "tonal color."

### TIP

You can also switch between voices in the same group by pressing a voice group button repeatedly.

### TIP

To learn characteristics of the voices, listen to demo songs for each voice group (page 22). Refer to "Preset Voice List" on page 109 for more information on characteristics of each preset voice.

### TIP

You can control the loudness of a voice by how hard you play the keyboard, although different playing styles (touch sensitivities) have little or no effect with the sound of certain musical instruments. Refer to "Preset Voice List" on page 109.

### TIP

XG is a major enhancement of the GM System level 1 format, and was developed by Yamaha specially to provide more voices and variations, as well as greater expressive control over voices and effects, and to ensure compatibility of data well into the future.

### TIP

If you select XG and then simultaneously press the VARIATION [▼][▲] buttons, the XG voice select screen will appear.

## Using the pedals

The Clavinova has three foot pedals: damper pedal (right), sostenuto pedal (center), and soft pedal (left) that produce a range of expressive effects similar to those produced by the pedals on an acoustic piano.

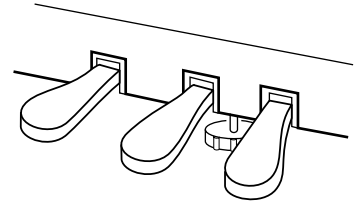

### Damper (right) pedal

When you press the damper pedal, the notes you play have a longer sustain. When you select Grand Piano 1, pressing the damper pedal activates the instrument's special "Sustain Samples" to accurately recreate the unique resonance of an acoustic grand piano's soundboard and strings.

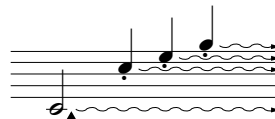

When you press the damper pedal here, the notes you play before you release the pedal have a longer sustain.

### Sostenuto (center) pedal

If you play a note or chord on the keyboard and press the sostenuto pedal while holding the note(s), the notes will sustain as long as the pedal is held. All subsequent notes will not sustain.

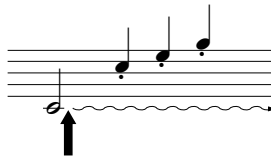

When you press the sostenuto pedal here while holding the note(s), the notes will sustain as long as you hold the pedal.

### Soft pedal (left)

The soft pedal reduces the volume and slightly changes the timbre of notes played while the pedal is pressed. (The soft pedal will not affect notes that are already playing when it is pressed. Press the pedal immediately before you play the target notes.)

With the Vibraphone and Jazz Organ voices, this pedal turns vibrato on and off or toggles the speed of vibrato. (See page 93.)

#### TIP

If the damper pedal doesn't work, or notes are sustained even when the pedal is not pressed, make sure that the pedal cord is properly plugged into the PEDAL jack on the unit (see step 5 on page 113 (CLP-150), see step 6 on page 116 (CLP-170)). Also, make sure that the RPedal parameter in the "VOICE SETTING" menu is set to ON (see page 83).

#### TIP

You can adjust the depth of the resonance produced by the "Sustain Samples" using the Sustain Sampling Depth parameter in the "OTHER SETTING" menu. (See page 93.)

#### TIP

You can assign a function to each pedal via the "R Pedal", "M Pedal", and "L Pedal" parameters in the "VOICE SETTING" menu. (See pages 83, 84.)

#### TIP

The center and left pedals can also be assigned to song start/stop operation (START/STOP function) via the "PedalStart/Stop" parameter in the "OTHER SETTING" menu (on page 94).

## Adding variation to the sound [BRILLIANCE]/[REVERB]/[CHORUS]

The Effect function enables you to add expression to the sound. The Clavinova effects include Brilliance, Reverb, and Chorus.



### [BRILLIANCE]

You can use this control to adjust the brilliance of the tone and change the tonality to suit your preference.

#### Procedure

Press one of the **BRILLIANCE [MELLOW]/ [BRIGHT]** buttons to select the desired tonality.



- Mellow3 } Soft and mellow tone.
- Mellow2 } The sound becomes more mellow and rounder as the
- Mellow1 } number increases.
- Normal..... Standard tone

- Bright1 } Bright tone.
- Bright2 } The sound becomes brighter as the number increases.
- Bright3 }

Press the **[EXIT]** button to return to the main screen.

#### TIP

You can press **BRILLIANCE [MELLOW] [BRIGHT]**, and then use **D [-][+]** to select the desired tonality.

#### TIP

Normal setting = Normal

#### TERMINOLOGY

**Normal setting:**  
The "Normal setting" refers to the default setting (factory setting) obtained when you first turn on the power to the Clavinova.

#### NOTE

If you select **[Bright1]**, **[Bright2]** or **[Bright3]** as the type of brilliance, the volume level will increase slightly. Under this condition, if you raise the **[MASTER VOLUME]** dial setting, the sound may become distorted. In this case, lower the volume accordingly.

---

**[REVERB]**

---

This control adds reverberation to the sound by simulating the natural reverberation of a concert hall.

**Procedure**

***Pressing the [REVERB] button repeatedly toggles the reverb on and off.***

Even if the reverb effect is turned off, a “soundboard reverb” effect will be applied when the GrandPiano1 or GrandPiano2 voice is selected.

**TIP**

You can select a reverb type via the Reverb Type parameter in the “VOICE SETTING” menu, and adjust the reverb depth for the selected voice via the Reverb Send parameter. (See page 79.)

**TIP**

Normal setting = ON

---

**[CHORUS]**

---

This control adds spread and spaciousness to the sound.

**Procedure**

***Pressing the [CHORUS] button repeatedly toggles the chorus on and off.***

You can turn the chorus effect on and off by pressing the [CHORUS] ON/OFF buttons on the panel and by setting the Chorus On Off parameter in the VOICE SETTING menu (see page 80). The [CHORUS] ON/OFF button setting on the panel is temporary. That is, if you select another voice, the chorus setting for the previous voice is cancelled. The Chorus On Off parameter setting is saved for each voice. That is, if you select a given voice, the chorus setting is automatically turned on or off according to the saved chorus setting.

**TIP**

You can select a chorus type via the Chorus Type parameter in the “VOICE SETTING” menu, and adjust the chorus depth for the selected voice via the Reverb Send parameter. You can also turn chorus on or off via the Chorus On Off parameter. (See page 79.)

**TIP**

**Normal Setting**

The normal chorus on/off setting is different for each voice.

## To enhance the acoustic realism of the sound ...[iAFC (Instrumental Active Field Control)] (CLP-170)

When iAFC is engaged, the Clavinova will sound deeper and more resonant, similar to an acoustic musical instruments.

Perform the automatic adjustment after you turn on the power of the Clavinova for the first time, and after each time you move the Clavinova. (page 86)



### Procedure

*iAFC will toggle on or off each time you press iAFC [ON/OFF] switch.*

#### TIP

##### How iAFC works

Sounds picked up by a mic and sounds produced internally by the Clavinova are processed and output from the rear speaker to enhance acoustic realism of the sound.

iAFC uses Yamaha's EMR (Electronic Microphone Rotator) technology to ensure stability against acoustic feedback.

#### TIP

**iAFC cannot be used in the following cases.**

- When the Speaker setting is Normal, and headphones are connected.
- When the Speaker setting is Off.

#### TIP

When using iAFC, do not block the speaker located on the rear panel of the Clavinova. The optimal iAFC effect cannot be obtained if this speaker is blocked.

#### TIP

[iAFC SETTING] lets you select the type of iAFC and adjust the depth of the effect. (page 85)

#### TIP

Normal setting = ON



## Combining two voices (Dual mode)

You can play two voices simultaneously across the entire range of the keyboard. In this way, you can simulate a melody duet or combine two similar voices to create a thicker sound. Refer to “Voice Combination Examples (Dual and Split)” on page 111 for examples of effective voice combinations.

The numbers on the upper row indicate the steps in Dual mode using voices from different groups.



The numbers on the bottom row indicate the steps in Dual mode using voices from the same group.

### Dual mode using voices in different voice groups

#### Procedure

#### 1. Enter Dual mode.

Press two voice group buttons simultaneously.

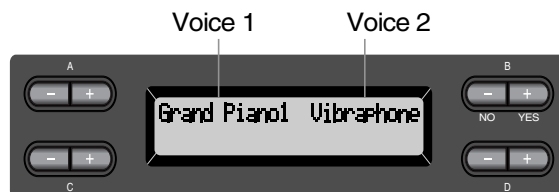

#### 2. Select a voice.

Use the A [-]/[+] buttons and B [-]/[+] buttons to select a voice.

The voices listed in the upper row in “Preset Voice List” on page 109 are called voice 1, and those listed in the bottom row are called voice 2.

#### 3. Exit Dual mode and return to normal play mode.

Press any voice group button.

#### TIP

If you want to select Dual mode for the left-hand area when the entire keyboard is divided into left and right areas (page 35), hold down [SPLIT] and simultaneously press two voice group buttons.

#### TIP

You can also use the VARIATION [▼]/[▲] buttons to select the voice 1.

#### TIP

Refer to page 28 for details on how to select XG voices.

---

## Dual mode using voices in the same voice group

---

### Procedure

---

- 1. Select a voice group.**  
*In normal play mode, press the desired voice group button.*
- 2. Select a voice.**  
*Use the A [-]/[+] buttons to select a voice.*
- 3. Select another voice.**  
*Use the B [-]/[+] buttons to select another voice in the same voice group.*

To use the identical voices, press the B [-]/[+] buttons once. To use different voices within the same voice group, press the B [-]/[+] buttons repeatedly.



- 4. Exit Dual mode and return to normal play mode.**  
*Press any voice group button.*

#### TIP

If you want to select Dual mode for the left-hand area when the entire keyboard is divided into left and right areas (page 35), press D [-] [+].

## Splitting the keyboard range and playing two different voices (Split mode)

Split mode enables you to play two different voices on the keyboard — one with the left hand and another with the right hand. For example, you can play a bass part using the [WOOD BASS] or [E. BASS] voice with the left hand, and a melody with the right hand. Refer to “Voice Combination Examples (Dual and Split)” on page 111 for examples of effective voice combinations.

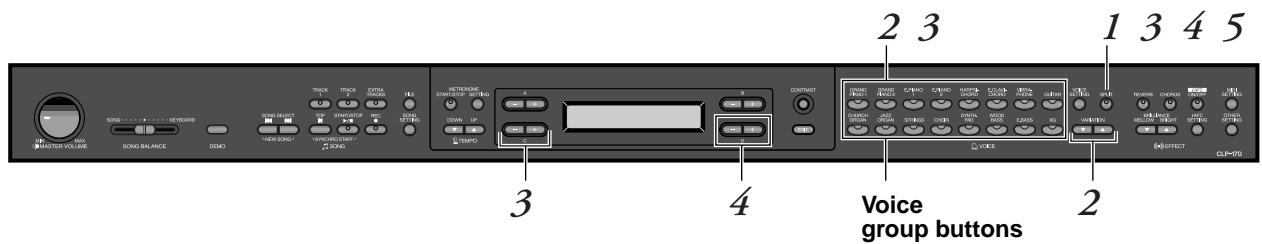

### Procedure

1. Enter Split mode.  
Press [SPLIT].
2. Select a voice for the right hand.  
Use the voice group buttons and VARIATION [▼][▲] to select the voice for the right-hand area.
3. Select a voice for the left hand.  
Hold down [SPLIT], and press a voice group button to select the voice group for the left-hand area.  
Use C [-][+] to select a voice.

**TIP**

You can also use A [-][+] to select a voice for the right-hand area.

**TIP**

Refer to page 28 for details on how to select XG voice.

**4. Specify the split point (the border between the right- and left-hand range).**

The normal setting of the split point is “F#2.”

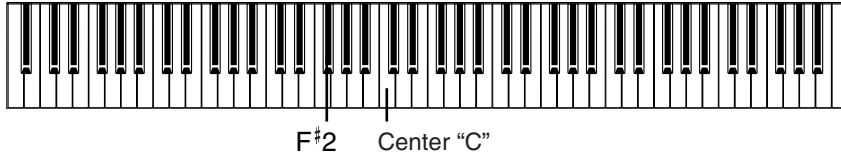

To change the split point setting:

**Hold down [SPLIT], then use the D [-]/[+] to specify the split point.**

**(Optional) Press and hold down the [SPLIT] and play the key you wish to assign as the split point.**



Release the [SPLIT] button to return to the main screen.

**5. Exit Split mode and return to normal play mode.**  
**Press [SPLIT].**

You can use Dual (see page 33) in each area (right-hand and left-hand) of Split mode.



**TIP**

A specified “split point” key is included in the left-hand range.

**TIP**

The split point can also be set by the [OTHER SETTING] parameter [Split-Point]. (page 92)

## Using the metronome

The Clavinova is built-in metronome (a device that keeps an accurate tempo) is a convenient feature for practice.

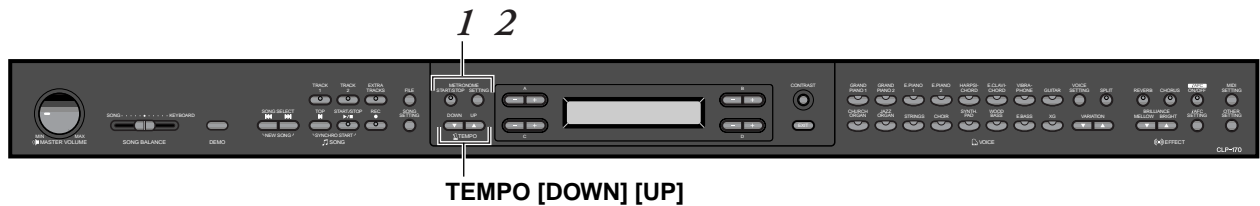

### Procedure

1. Start the metronome.  
Press the **METRONOME [START/STOP]** button.

When the metronome is sounding, the beat indicator flashes at the current tempo.

### Adjusting the tempo

Press the **TEMPO [DOWN]** or **[UP]** button.

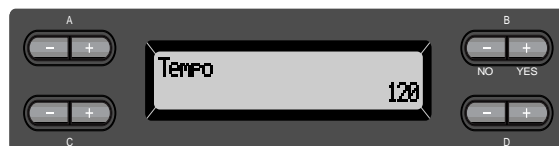

To adjust the tempo (number of beats per minute: 10–500), use the **TEMPO [DOWN]/[UP]** or the **D [-]/[+]** buttons. To reset the tempo to the normal (default) setting, press the **[DOWN]** and **[UP]** keys or the **D [-]** and **[+]** keys simultaneously.

Press the **[EXIT]** button to return to the normal screen.

2. Stop the metronome.  
Press the **METRONOME [START/STOP]** button.

#### TIP

The default tempo is 120. (If a song has been selected, the song tempo is used.)

#### TIP

You can set the time signature, metronome volume, and metronome tone using the **METRONOME [SETTING]** button. (See page 76.)

# Recording Your Performance

This chapter explains how to record your performance using the Clavinova recording function.

You can, for example, play back what you have played on the Clavinova keyboard for an effective practice aid. You can also record just the left-hand part, then practice the right-hand part while playing back the recorded left-hand part.

Since you can record up to sixteen tracks separately, you could record the left- and right-hand parts separately, or record each part of a four-handed performance or ensemble song one by one to build a song.

## TIP

You can record your performance (audio data) to a cassette tape recorder or other recording devices via the AUX OUT connector. (see page 60.)

## TERMINOLOGY

### Recording vs. Saving:

The format of performance data recorded on a cassette tape differs from that of data recorded on the Clavinova. A cassette tape records audio signals. On the other hand, the Clavinova “saves” information regarding note timing, voices, and a tempo value, but not audio signals. When you play back recorded songs, the Clavinova produces sound based on the saved information. Therefore, recording on the Clavinova may be more accurately called “saving information.” However, this book often uses the word “recording” because it seems to make more sense.

A message (information or confirmation dialog) sometimes appears on the screen to facilitate operation. Refer to the “Message List” on page 96 for an explanation of each message, appropriate actions to take, and troubleshooting information.

## Recording a New Song

### Recording to [TRACK 1]

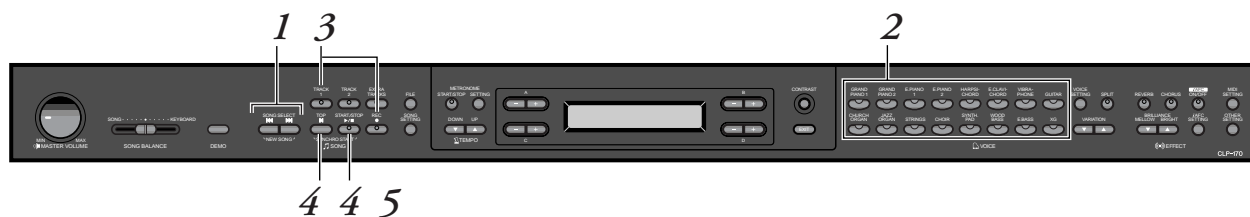

## Procedure

1. Select “NewSong” for recording.  
Press the SONG SELECT [◀◀] [▶▶] buttons simultaneously.

New Song screen



## NOTE

If you select a song other than “P-000: NewSong” and record on a track that already has data, the existing data on the track will be lost.

## 2. Select a voice.

**Select a voice (or voices) for recording (see page 28).**

Set the other parameters, such as reverb and chorus.

Adjust the [MASTER VOLUME] dial to set the volume level to suit your preference. You can also use the dial to adjust the level during playback.

After you set the tempo or if the record standby screen does not appear, press one of the SONG SELECT [◀◀] [▶▶] buttons once to return to the New Song screen.

## 3. Enter record mode and select a recording track.

**Press and hold down the [REC] button and press the [TRACK 1] button.**

The [TRACK 1] indicator flashes in red. (To cancel recording, press the [REC] or [TOP] button.)

**Record standby screen**



Set the tempo, if necessary.

If this record standby screen does not appear, press one of the SONG SELECT [◀◀] [▶▶] buttons once.

## 4. Start and stop recording.

**Recording begins automatically as soon as you play a note on the keyboard.**

(Optional) Press the SONG [START/STOP] button to start recording. The recording screen displays the current measure number.

**Record screen**



Measure number in recording

**To stop recording, press the [TOP] button. The Clavinova locates the top of the song.**

The [TRACK 1] indicator lights up in green. (Record mode is automatically cancelled.)

### NOTE

Set the tempo in Step 3.

### NOTE

See page 45 for more information on recording in Dual/Split mode.

### TIP

You can record data while using the metronome. The metronome is not recorded.

### TIP

When you press the SONG [START/STOP] button during recording, recording is paused. To resume recording, press the SONG [START/STOP] button again or play a note on the keyboard.

### TIP

When you press the [REC] button, recording pauses.

- 5. Play back the recorded performance.**  
***Press the SONG [START/STOP] button to play back the recorded performance.***

When playback is complete, it automatically stops and the Clavinova locates the top of the song. To stop playback in the middle of a song, press the [TOP] button. You can also pause playback by pressing the SONG [START/STOP] button. Playback stops when you press the button.

When you turn off the power to the Clavinova, the recorded performance data will be lost. If you wish to keep the recording, save the data using the SaveToMemory parameter (page 48) or SaveToDisk parameter (CLP-170) (page 49) in the File menu.

**NOTE**

To erase recorded data from a track, use the Channel Clear parameter in the "SONG SETTING" menu. (See page 74.)

---

## Re-recording TRACK 1

---

This section explains how to record again in case your performance was not satisfactory.

### ***Procedure***

---

- 1. Select a voice or voices for recording, if necessary.**  
***Repeat Step 2 on page 39 if you wish to change the previous settings.***

Follow the procedure from Step 3 on page 39 to re-record.

The original performance data will be overwritten by new performance data.



## Re-recording TRACK 1 partially

This section explains how to record part of a song again.

### Procedure

1. Pause the song at the beginning of the part you wish to re-record.  
Use the B [-]/[+] buttons while the playback screen is displayed to move through the measures or play back the recording and press the SONG [START/STOP] button to locate a point slightly prior to the beginning of the part you wish to re-record.

Playback screen



2. Select a voice or voices for recording, if necessary.  
Repeat Step 2 on page 39 if you wish to change the previous settings.
  3. Select the recording method and enter record mode.
- 3-1** Press and hold down the [REC] button, and press the C [-]/[+] buttons repeatedly to specify how the recording should start and press the D [-]/[+] buttons repeatedly to specify how the recording should end.  
While you are holding down the [REC] button, the following recording method select screen appears.

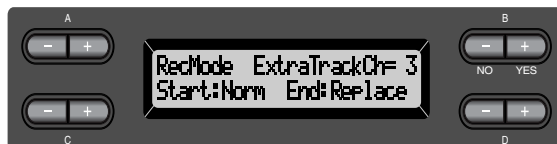

#### Starting methods:

Norm (Normal) — The existing data will be erased after re-recording starts.

Key On — Data that exists prior to the point where you start playing a note will not be erased.

#### NOTE

If the playback screen is not displayed, press one of the SONG SELECT [◀◀] [▶▶] buttons once.

### Ending methods:

Replace – The data after the point you stop recording will also be erased.

Punch Out — The data after the point you stop recording will remain.

## 3-2 Keep holding down the [REC] button and press the [TRACK 1] button.

The [TRACK 1] indicator flashes in red.

(To stop recording, press the [REC] button again or press the [TOP] button.)

Follow the procedure beginning with Step 4 on page 39.

### TIP

If you cancel recording by pressing the [REC] button, recording stops when you press the button. If you cancel recording by pressing the [TOP] button, the Clavinova locates the top of the song.

---

## Recording to [TRACK2]

---

This section explains how to record another part on the second track.



### Procedure

- 1. Select a voice.**  
*Select a voice (or voices) for recording.*  
*Repeat Step 2 on page 39.*
- 2. Enter record mode and select a recording track.**  
*Press and hold down the [REC] button and press the [TRACK 2] button.*

The [TRACK 2] indicator flashes in red. (To cancel recording, press the [REC] or [TOP] button.)

### TIP

Pressing the [TRACK 1] button repeatedly toggles between playback on (the indicator lights up in green) and off (the indicator turns off).

Make the recording by following the procedure beginning with Step 4 on page 39.

You can record a new part while listening to playback of the recorded [TRACK 1] data.

---

## Recording to the third or more tracks [EXTRA TRACKS]

---

You can continue recording other parts into tracks 3–16 [EXTRA TRACKS] one by one.

### Procedure

1. Hold down the [REC] button in step 2 in the “Recording to [TRACK2]” on page 42 and use the B [-]/[+] buttons to select a recording track (3–16).

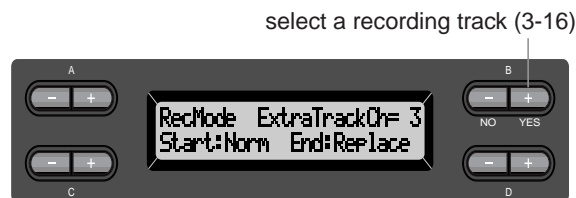

2. While holding down the [REC] key, press the [EXTRA TRACKS] button.

Then, follow the procedure beginning with Step 4 on page 39.

---

## Other recording techniques

---



---

### Adding data to or recording over an existing song

---

The previous section explains how to record your performance from the beginning by selecting a blank “P-000: NewSong.” You can also add your performance to or overwrite existing songs (such as 50 preset songs [P-001—P-050], commercially-available music data [see page 58], or your old recorded performances [see page 46]).

### Procedure

1. **Select a song for recording (P-001 – P-050).**  
Select one of the preset songs (P-001–P-050) instead of “P-000: NewSong” as described in Step 1 of “Recording to [TRACK1]” on page 38. To select a song from commercial music data sold in stores or from already-recorded data, see Steps 1 and 2 on page 55.

#### NOTE

If you record on a track that already has data, the existing data on the track will be lost.

To continue recording, follow the procedure described in “Recording a New Song” from page 38 to 43.

---

## Changing a voice or tempo after recording

---

You can change the voice and tempo after recording to change a song's feel or to set a more suitable tempo. You can also change these elements in the middle of a song.

### Procedure

**1. Select a song you wish to change by using the SONG SELECT [◀◀] [▶▶] buttons.**

**2. To change the voice or tempo in the middle of the song, specify the measure to change using the B [-]/[+] buttons.**

**3. Change the settings (voice, reverb, etc.).**  
For example, if you wish to change the recorded E.Piano1 voice to E.Piano2, use the voice group buttons and the A [-]/[+] buttons to select E.Piano2.

When the setting is complete, press one of the SONG SELECT [◀◀] [▶▶] buttons once to return to the song select screen.

**4. Press and hold down the [REC] button and select the track to change.**

The indicator for the selected track lights up in red. Change the tempo setting now, if necessary.

At this point, do not play the keyboard or press the SONG [START/STOP] button. Otherwise, recording will start, erasing the recorded data.

**5. Press the [TOP] or [REC] button to exit record mode.**

#### NOTE

Before changing a voice or tempo, set the starting method to "Normal." (page 41)

When the starting method is set to "KeyOn," you cannot change a voice or tempo.

#### TIP

Refer to "Questions about Operations and Functions" on page 102 for information on the settings that can be changed here.

#### TIP

Change the tempo in Step 4.

#### CAUTION

The edited settings (except for the tempo setting) will be saved in memory and you will not be able to restore the previous settings. Proceed with caution.

## Adjusting the volume balance between playback and your performance [SONG BALANCE]

While recording multiple parts into tracks one by one, you can adjust the volume balance between the playback of the recorded parts and your current performance.

### Procedure

1. Move [SONG BALANCE] to the left or right to make adjustments.

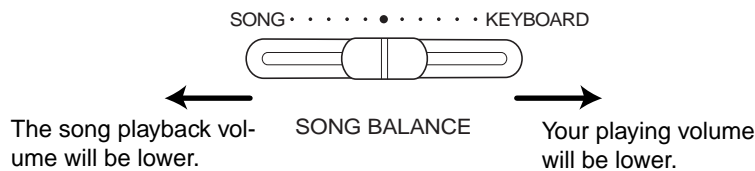

**TIP**

Some commercially-available music data contains extremely high volumes. When using such data, please adjust the song balance.

**TIP**

The song balance setting is also used during playback. (See page 55.)

## Recording in Dual or Split mode

When you record in Dual or Split mode, the Clavinova records each voice onto a separate track. The following table shows how tracks are assigned to each voice.

**CAUTION**

When you record multiple parts into tracks one by one, or when you record new data over an existing song (see page 43), the existing data will be erased. Proceed with caution.

In the following example, Tracks 1, 2, and EXTRA TRACKn have been selected for recording.

Tracks assigned for recording	Dual			Split			Split+Dual		
	TRACK1	TRACK2	EXTRA TRACKn	TRACK1	TRACK2	EXTRA TRACKn	TRACK1	TRACK2	EXTRA TRACKn
	↓	↓	↓	↓	↓	↓	↓	↓	↓
Tracks used for recording	MAIN (voice 1)	TRACK1	TRACK2	TRACKn	TRACK1	TRACKn	TRACK1	TRACKn	
	LEFT (voice 1)	—			TRACK2	TRACKn+1	TRACK2	TRACKn +1	
	MAIN (voice 2)	TRACK3	TRACK4	TRACKn +2	—			TRACK3	TRACKn +2
	LEFT (voice 2)	—			—			TRACK4	TRACKn +3

Note: TRACKn = TRACK 3 – TRACK 16  
If “n+1,” “n+2,” and “n+3” exceed 16, TRACKs 1, 2, and 3 are used.

**TIP**

Switching between Dual and Split mode in a song is not recorded.

# Saving Recorded Songs and Handling the Files...[FILE]

File screens (accessed via the [FILE] button) enables you to handle song files (e.g., save, delete, and rename recorded songs), copy and format disks (CLP-170), and change the characters on the screen.

The following parameters are provided for these operations:

Settings	Parameter name	Reference page
Saves recorded and other songs in Clavinova memory	SaveToMemory	48
Saves recorded and other songs on floppy disks (CLP-170)	SaveToDisk	49
Deletes a song from the Clavinova's save memory or (CLP-170 only) from a floppy disk	DeleteSong	50
Changes the title of songs	RenameSongs	51
Copies data from floppy disk to floppy disk (CLP-170)	CopyDisk	52
Formats a floppy disk (CLP-170)	FormatDisk	53
Automatically open a song when the disk is inserted (CLP-170)	FloppyDisk SongAutoOpen	54
Change the type of characters on the screen	CharCode	54

## Clavinova memory

The Clavinova has the following three types of memory:

- **Current memory:**  
This is a temporary memory area where you can temporarily place and edit the currently-selected song before playback or recording.
- **Preset song memory:**  
This read-only memory area saves 50 piano preset songs.
- **Storage memory:**  
This memory area enables you to save recorded songs or song data loaded from floppy disk (CLP-170).

When you select a song in the song select screen, it is loaded from Preset song memory, Storage memory, or floppy disk (CLP-170), into Current memory. You will use Current memory to play back and record songs. When you turn off the power to the Clavinova, songs saved in Preset song memory and Storage memory are not erased. On the other hand, songs in Current memory are lost. If you wish to keep a song in Current memory, you must save it in Storage memory or on a floppy disk (CLP-170) (see pages 48, 49).

In this manual, a song located in a song recorded in Current memory, is referred to as a “**Current song**,” a song in Storage memory is a “**Memory song**,” and a song on a floppy disk is a “**Disk song**” (CLP-170).

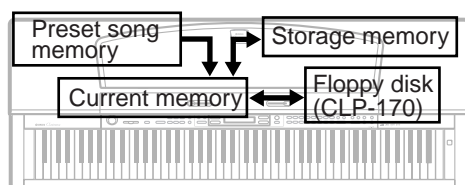

Clavinova

## TERMINOLOGY

### File

A file contains a group of data. On the Clavinova, a song file includes song data and a song number.

### Memory

Memory is a location inside the Clavinova in which you can save and edit data.

### Formatting (Initializing) (CLP-170)

Floppy disks are a convenient media that allow you to save various data for personal computers and other devices. There are many ways (formats) to save data on floppy disks, depending on the device. Therefore, you need to prepare a floppy disk by assigning a format before you can use it on a particular type of device. This operation is called “formatting.”

### Character code

Type of characters

## TIP

Please note that the copy features are intended for your personal use only.

## Basic file operation

A message (information or confirmation dialog) sometimes appears on the screen to facilitate operation. Refer to the “Message List” on page 96 for an explanation of each message, appropriate actions to take.

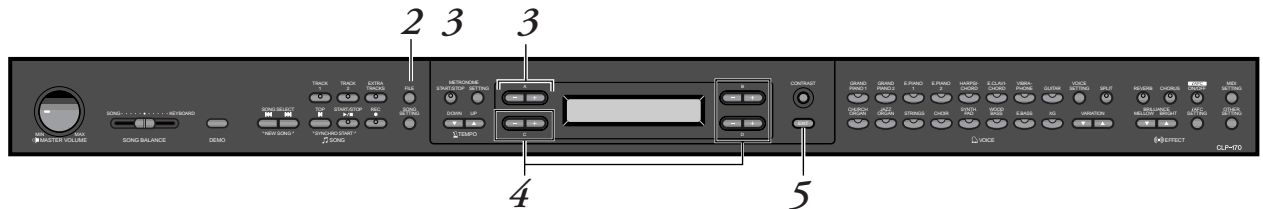

## Procedure

### 1. Select a song / (CLP-170 only) Prepare a disk.

Select a song you wish to save or rename.

(Optional) Insert a floppy disk for copying or formatting into the disk drive (CLP-170).

### 2. Access the File menu.

Press the [FILE] button.



To close the File menu, press the [EXIT] button once or twice.

### 3. Select the desired parameter.

Press the [FILE] or A [-]/[+] buttons repeatedly to display the desired item from the following:

“SaveToMemory”, “SaveToDisk” (CLP-170), “DeleteSong”, “Rename-Song”, “CopyDisk” (CLP-170), “FormatDisk” (CLP-170), “Floppy-DiskSongAutoOpen” (CLP-170), “CharacterCode”.

### 4. Set the parameter or execute the command.

Use the B [- (NO)]/[+ (YES)], C [-]/[+], D [-]/[+] buttons.

For more information regarding this procedure, refer to the corresponding section below.

### 5. Close the File menu.

Press the [EXIT] button.

## Saving recorded or other songs to Clavinova Storage memory...[SaveToMemory]

If you record a song, then turn off the power to the Clavinova, the song will be erased. To save the recorded song, you must save it into the Clavinova Storage memory or to a floppy disk (CLP-170). (To save a song to a floppy disk, refer to the next section [SaveToDisk].) You can also save the preset songs, disk songs, and additional or overwriting recordings (page 43) to Storage memory.



### Procedure

See page 47 the basic operation information. The following is a detailed procedure of Step 4.

#### 4-1 Name the song.

To move the cursor (a small underline), use the C [-]/[+] buttons.  
 To insert a space, press the C [-]/[+] buttons simultaneously.  
 To select a character on the cursor, use the D [-]/[+] buttons.  
 To delete a character, press the D [-]/[+] buttons simultaneously.

You can use up to 58 characters for a song name. If the name is longer than the screen, use the C [-]/[+] buttons to move the cursor and scroll the name.

#### 4-2 Execute the operation.

Press the B [+ (YES)] button located next to "Execute?->".  
 "Sure?->" appears on the screen. Press the B [+ (YES)] button again to confirm the operation. (To cancel the operation, press the B [- (NO)] button.)  
 The Clavinova displays "Executing" on the screen during the operation. When the operation is complete, "Completed" appears.  
 The song is automatically numbered as "M—," where "M" means "Memory" and "—" is a number.

#### TIP

If Storage memory contains one or more songs, and you save a new song, the Clavinova automatically sorts the songs alphabetically and renumbers them.

#### TIP

- You can change the type of characters on the screen using the CharacterCode parameter.
- When you select a saved song later, the name with an extension ".MID" will appear.

#### TERMINOLOGY

"Execute?->": Do you wish to execute the operation?

"Sure?->": Are you sure?

"Executing": The Clavinova is executing the operation.

"Completed": The operation is complete.

#### CAUTION

Do not turn off the power while the screen displays "Executing."



## Saving recorded or other songs to floppy disk...[SaveToDisk] (CLP-170)

Songs you record, memory songs, or recordings you added or recorded over (page 43) previously-recorded memory songs can be saved on a floppy disk.



### Procedure

See page 47 for basic operation information. The following is a detailed procedure of Step 4.

#### 4. Make sure that a formatted floppy disk (page 53) is inserted in the disk drive.

Follow the steps for the [SaveToMemory] operation (see page 48) to name and save the song.

The song is automatically numbered as “D—,” where “D” means “Disk” and “—” is a number.

#### TIP

The song data is saved in the SMF format (format 0). Therefore, you can play the disk on instruments that support the SMF format.

#### TIP

To specify a folder on the disk as the save location ... When the “Sure?->” display appears, press either C [-][+] to display the folder. Use C [-][+] to select the folder. You can use D [+] to enter a folder. Press D [-] to return to the previous (higher) level.

#### CAUTION

Do not turn off the power or eject the floppy disk while the screen displays “Executing.”

## Deletes a song from the Clavinova's save memory or (CLP-170 only) from a floppy disk...[DeleteSong]

This deletes a song from memory or (CLP-170 only) from disk. It is not possible to delete a preset song or the current song.



### TIP

To delete a Current song, select "ALL" for the Channel-Clear parameter in the "SONG SETTING" menu (page 74). Alternatively, press the SONG SELECT [◀◀]/[▶▶] buttons simultaneously to display "Song Changed Save?". This means "A song has been edited. Do you wish to save the change?" Press the B [-] (NO) button. The Current song is deleted and a blank "NewSong" is selected.

### Procedure

See page 47 for basic operation information. The following is a detailed procedure of Step 4.

#### 4-1 Select a song to delete.

Use the C [-]/[+] buttons to select a song.

#### 4-2 Execute the operation.

Press the B [+ (YES)] button located next to "Execute?->".  
Follow the instructions on screen.

### TIP

If you select a Memory song or Disk song, deleting the song does not erase song data from Current memory. However, if you return to the song select screen, song information other than the song name is replaced by "-----".

### TIP

After you delete a song, the Clavinova automatically updates the song numbers.

### TIP

When you delete a folder from disk, all files within that folder will be deleted. (CLP-170)

### TIP

If a folder is displayed for a disk song (CLP-170), the [↑/↓] indicator is displayed in the lower right of the screen. In this case, you can use the D [+] key to open the folder. Press the D [-] key to return to the previous (upper) level.

### CAUTION

Never turn off the power or remove the floppy disk while [Executing] is displayed.

## Renaming a song...[RenameSong]

You can change a song's title except for the preset songs and [P-000: NewSong].



### Procedure

See page 47 for basic operation information. The following is a detailed procedure for Step 4.

4. Name the song as described in the [SaveToMemory] section (page 48).

#### CAUTION

Do not turn off the power or eject the floppy disk while the screen displays "Executing."

#### TIP

After you rename a song, the Clavinova sorts songs alphabetically and renumbers them.

---

## Copying data from one floppy disk to another...[CopyDisk] (CLP-170)

---

You can copy the entire contents of one floppy disk to another floppy disk.



### Procedure

---

See page 47 for basic operation information. The following is a detailed procedure for Step 4.

- 4-1** Make sure that a formatted floppy disk is inserted in the disk drive.
- 4-2** Press the B [+ (YES)] button located next to “Execute?->.”
- 4-3** When the screen indicates “Insrt Target Disk”, eject the source disk and insert the destination disk.  
When the copy operation is complete, the Clavinova displays “Completed.”

#### TIP

Use the same type of disk (2DD or 2HD) for the destination disk as the source disk.

#### TERMINOLOGY

**Insrt Target Disk:**  
Insert the destination (target) disk.

#### CAUTION

Do not turn off the power or eject the floppy disk while the screen displays “Executing.”

---

## Formatting a floppy disk...[FormatDisk] (CLP-170)

---

You can format a floppy disk so that it can be used with the Clavinova.



### Procedure

Refer to page 47 for the basic procedure.

Perform the following operations in step 4.

**4-1** Make sure that the formatted floppy disk is inserted in the disk drive.

**4-2** Press the B [+ (YES)] button located next to "Execute?->."

Follow the instructions on screen.

#### CAUTION

Do not turn off the power or eject the floppy disk while the screen displays "Executing."

## Automatically open a song when the disk is inserted [FloppyDiskSongAutoOpen] (CLP-170)

Specify whether a song will automatically be opened when you insert a disk.



### Procedure

Refer to page 47 for the basic procedure.  
Perform the following operation in step 4.

- 4 Use D [-][+] to select ON or OFF.

## Changing the type of characters on screen...[CharacterCode]

You can change the type of characters that appear on screen.  
The default setting is “International.” To input katakana, change this setting to “Japanese.”



Options: International, Japanese

### Character list

#### [International]

0~9	A~Z	a~z	Ä	Ë	Ï	Ö	Ü	ä	ë	ï	ö	ü	à	è	ì	ò	ù	á	é	í	ó	ú	â	ê	î	ô	û	Ñ	ñ	Ç	ç	°	ı	ı	!	#	\$	%	&	'	(	)
+ , - . ; = @ [ ] ^ _ ` { } ~																																										

#### [Japanese]

0~9	A~Z	a~z	ア	ン	ア	オ	ヤ	ユ	ヨ	ツ	ッ	°	ー	。	「	」	、	・	!	#	\$	%	&	'	(	)	+	,	-	.	;	=	@	[	]	^	_	`	{	}	~
-----	-----	-----	---	---	---	---	---	---	---	---	---	---	---	---	---	---	---	---	---	---	----	---	---	---	---	---	---	---	---	---	---	---	---	---	---	---	---	---	---	---	---

# Playing Back Recorded Songs and Commercially-available Music Data

You can play back songs recorded using the Record function (page 38) as well as commercially-available music data. You can also play the keyboard along with the playback.

## TIP

Songs containing a large amount of data may not be able to be read properly by the instrument, and as such you may not be able to select them. The maximum capacity is about 200–300KB, however this may differ depending on the data contents of each song.

## TIP

See page 57 for information on the types of song data that can be played on the Clavinova.

## TIP

Change the Clavinova's character type ([Character-Cord]) as appropriate for the selected song.

## Playing back a song

If you want to play back a disk song on the CLP-170, insert the floppy disk into the disk drive.

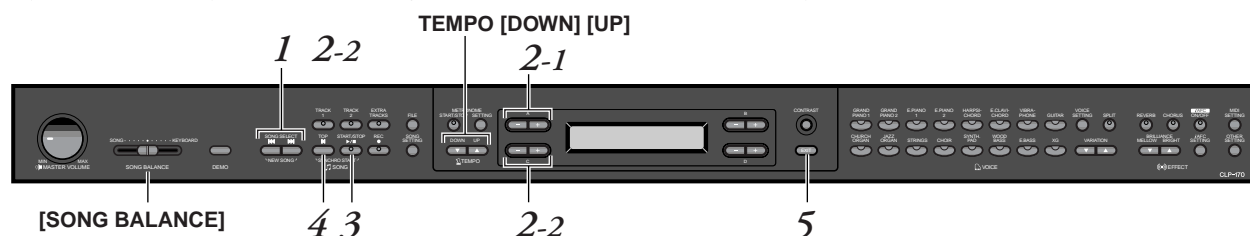

## Procedure

1. Display the song select screen.  
Press either the SONG SELECT [ $\ll$ ]/[ $\gg$ ] buttons.

Song select screen



2. Select the desired song.
  - 2-1 Use the A [-]/[+] buttons to select the song type: "PresetSong," "MemorySong," or "DiskSong" (CLP-170).  
If the internal Storage memory contains one or more songs, the Clavinova displays "MemorySong." If a floppy disk that contains song data is inserted in the drive, the Clavinova displays "DiskSong" (CLP-170).
  - 2-2 Use the C [-]/[+] or SONG SELECT [ $\ll$ ]/[ $\gg$ ] buttons to select a song.

## TIP

You can enjoy ensemble performance by yourself. Record the parts for a four-handed song or a piano duet, then play the recorded part while playing the other part on the keyboard.

## TIP

Use the SongRepeat parameter in the "SONG SETTING" menu (page 75) to select repeat playback of all songs or repeat playback of a single song.

## TIP

If a folder is displayed for a disk song (CLP-170), the [ $\uparrow$ ]/[ $\downarrow$ ] indicator is displayed in the lower right of the screen. In this case, you can use the D [+] key to open the folder. Press the D [-] key to return to the previous (upper) level.

## TIP

If the song name extends beyond what can be displayed in the screen, you can press D [+] to move toward the right in steps of one character. Press D [-] to move back to the left in steps of one character.

### 3. Start playback.

Press the SONG [START/STOP] button.

#### Starting playback automatically as you start playing the keyboard (Synchro Start)

You can start playback as soon as you start playing the keyboard. This is called the “Synchro Start” function.

To enter Synchro Start standby mode, press and hold down the [TOP] button and press the SONG [START/STOP] button. The SONG [START/STOP] indicator flashes.

Now play the keyboard. Playback starts simultaneously.

To cancel the Synchro Start function, press the [TOP] button while the Clavinova is in Synchro Start standby mode.

You can move back and forth (rewind and fast forward) through the bars by using the B [-]/[+] buttons in the song select screen while the Clavinova is playing or stopped.

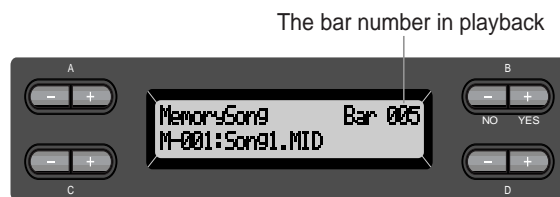

You can play the keyboard while the Clavinova is playing back a song. You can also play the notes in a voice different from the playback voice by selecting the voice from the panel, and adjusting the volume balance between the playback parts and your current performance using the [SONG BALANCE] slider. (See page 45.)

Press either of the SONG SELECT [◀◀]/[▶▶] buttons to return to the song select screen.

#### Adjusting the tempo

You can use the TEMPO [DOWN]/[UP] buttons to adjust the playback tempo as required before or during playback. The default tempo (the song’s original tempo) is set when you press the [DOWN] and [UP] buttons simultaneously.

Press either of the SONG SELECT [◀◀]/[▶▶] buttons to return to the song select screen.

### 4. Stop playback.

When playback is complete, the Clavinova automatically stops and locates the top of the song. To stop playback in the middle of a song, press the [TOP] button. You can also pause playback by pressing the SONG [START/STOP] button. Playback stops when you press the button.

#### TERMINOLOGY

**Bar:** measure

#### TIP

You can play the metronome along with the song playback. When you stop playback, the metronome is also stopped.

#### TIP

**In the song select screen:**

- Press the SONG SELECT [◀◀] or the C[-] button while playback is stopped in the middle of the song to locate the top of the song. However, if you have selected a disc song (CLP-170) and there is a folder before the song, the folder will appear on the display when you press the SONG SELECT [◀◀] [▶▶] buttons or C [-]/[+] buttons during song playback.
- Press the SONG SELECT [◀◀] or the C[-] button during playback to restart playback from the top of the song.
- Press the SONG SELECT [▶▶] or the C[+] button during playback to start playback from the next song.



**5. Return to the main screen.**  
**Press the [EXIT] button.**

Eject the floppy disk from the disk drive if you have been playing a disk song (CLP-170).

---

## ***Turning track playback on and off***

---

When you select a song on the Clavinova, the indicators for tracks that contain data ([TRACK 1], [TRACK 2], [EXTRA TRACKS]) are lit in green. While the Clavinova is playing or stopped, pressing these track buttons turn off the indicators, and the data on those tracks will not be played. Pressing the track buttons toggles track playback on and off. You can play the part that is turned off.

**TIP**

You can practice a part or phrase using the FromToRepeat (page 74) and Phrase-Mark parameters (page 75) in the "SONG SETTING" menu.

---

## ***Supported song data type***

---

### **Data formats that can be played on the CLP-170/150**

The Clavinova CLP-170/150 plays song data in the following formats:

#### Floppy disk format (CLP-170)

- 3.5-inch 2DD disks in the MS-DOS 720KB format
- 3.5-inch 2HD disks in the MS-DOS 1.44MB format

#### Sequence format

- SMF (Standard MIDI File) formats 0 and 1
- ESEQ
- Performance data recorded on the CLP-170 is saved in the SMF format 0 in a floppy disk.

**TERMINOLOGY**

**Disk format (CLP-170):**

A structured method for writing data to disk.

**TERMINOLOGY**

**Sequence format:**

A structured method for recording performance data.

Voice arrangement format

- XG voice arrangement
- GM system level 1 voice arrangement
- DOC voice arrangement (CLP-170)

Performance data recorded with preset XG voices on the CLP-170/150 can be played on other XG-compatible instruments.

See page 6 of the separate “Reference Booklet” for the XG voice list. Refer to “Data compatibility” on page 107 for more information on formats.

**TERMINOLOGY**

**Voice arrangement format:**

A structured method for numbering the voices for assignment.

# Connections

## Connectors

### ⚠ CAUTION

Before connecting the Clavinova to other electronic components, turn off the power to all the components. Before turning the power on or off to all components, set all volume levels to minimum (0). Otherwise, electrical shock or damage to the components may occur.

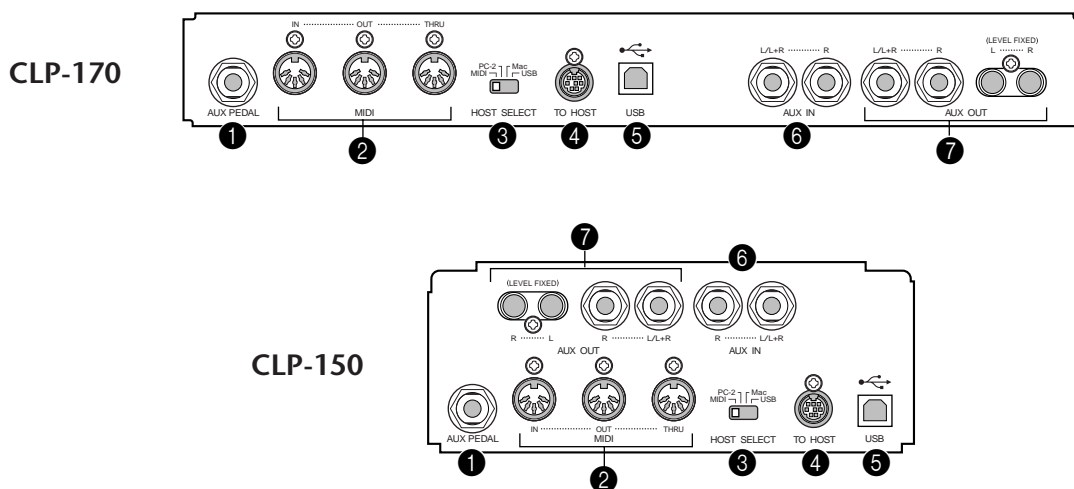

### ❶ AUX PEDAL jack

A separately sold FC7 foot controller or FC4/FC5 foot switch can be connected to this jack. By using an FC7 you can control the volume while playing to add expression to your performance, or control various other functions. By using an FC4/FC5, you can switch various selected functions on/off. To select the function that will be controlled, use the [VOICE SETTING] parameter [AuxPedal] (See page 84). The SONG [START/STOP] function can also be assigned to a foot switch (See page 94).

### ❷ MIDI [IN], [OUT], [THRU] connectors

Use MIDI cables to connect external MIDI devices to these connectors. Make sure you set the HOST SELECT switch (described on the previous page) to MIDI when you use these connectors.

### ❸ HOST SELECT switch

This switch should be set according to the type of connected MIDI device or personal computer. (Refer to “Connecting a personal computer” on page 61 for more information.)

### ❹ TO HOST jack

This jack allows direct connection to a personal computer. (Refer to “Connecting a personal computer” on page 61 for more information.)

### ❺ USB jack

This jack allows direct connection to a personal computer. (Refer to “Connecting a personal computer” on page 61 for more information.)

### TIP

Connect or disconnect the pedal when the power is off.

**6 AUX IN [R], [L/L+R] jacks**

The stereo outputs from another instrument can be connected to these jacks, allowing the sound of an external instrument to be reproduced via the Clavinova's speakers. Refer to the diagram below and use audio cables for connection.

**⚠ CAUTION**

When the Clavinova's AUX IN jacks are connected to an external device, first turn on the power to the external device, then to the Clavinova. Reverse this order when you turn the power off.

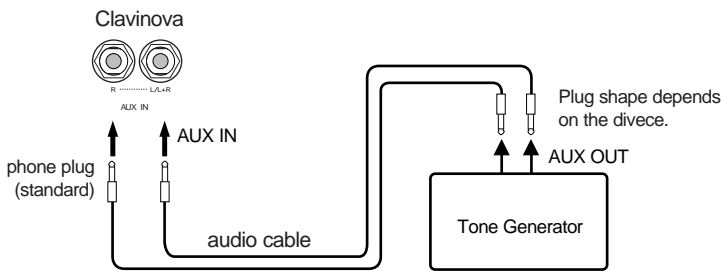

**7 AUX OUT [R][L] Pin jacks (LEVEL FIXED), [R][L/L+R] Phone jacks**

These jacks let you connect the Clavinova to your stereo system etc. to play at higher volumes, or connect a cassette recorder etc. to record your playing. Use audio cables to make connections as shown in the diagram.

**⚠ CAUTION**

When the Clavinova's AUX OUT jacks are connected to an external audio system, first turn on the power to the Clavinova, then to the external audio system. Reverse this order when you turn the power off.

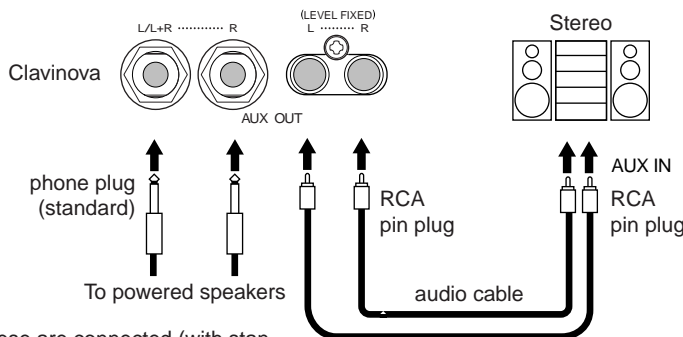

When these are connected (with standard phone plugs), you can use the [MASTER VOLUME] control to adjust the volume of the sound output to the external device.

When these are connected (with RCA pin plug; LEVEL FIXED), the sound is output to the external device at a fixed level, regardless of the [MASTER VOLUME] control setting.

**TIP**

The Clavinova's [MASTER VOLUME] dial setting affects the input signal from the AUX IN jacks, but the [REVERB], [CHORUS], and BRILLIANCE [MELLOW] [BRIGHT] (page 30) settings do not.

**TIP**

If you connect the Clavinova to a monaural device, use only the AUX IN [L/L+R] jack or AUX OUT [L/L+R] jack.

**⚠ CAUTION**

Do not route the output from the AUX OUT jacks to the AUX IN jacks. That is, when you connect an external audio device to the AUX OUT jacks, do not connect the audio device to the Clavinova's AUX IN jacks. If you make this connection, the signal input at the AUX IN jacks will be output from AUX OUT. This creates an audio loop, causing audio oscillation and abnormal playback, and leading to malfunction of both pieces of equipment.

**TIP**

Use audio cables and adaptor plugs with no resistance.

**TIP**

The Clavinova's [MASTER VOLUME] setting will not affect the sound that is output from AUX OUT (LEVEL FIXED).

---

## Connecting a personal computer

---

You can connect the [TO HOST], MIDI [IN][OUT][THRU], or [USB] connector of the Clavinova to your personal computer and enjoy using the Clavinova in conjunction with musical software on your computer.

“**The Clavinova-Computer Connection,**” is a supplementary guidebook that describes, for beginners, what you can do with your Clavinova and a personal computer and how to set up a Clavinova-Computer system (the manual is not written for any specific models). The document is available as a PDF file (in English) at the following Internet address:

Clavinova Web site (English only):

<http://www.yamahaclavinova.com/>

Yamaha Manual Library:

<http://www2.yamaha.co.jp/manual/english/>

There are the three methods by which to connect the Clavinova to a personal computer:

1. Connecting the serial port on the computer to the Clavinova's TO HOST jack (page 59)
2. Using a MIDI interface and the Clavinova's MIDI connectors (page 59)
3. Connecting the USB port on the computer to the Clavinova's USB jack (page 59)

For more information, refer to the following pages.

### TIP

When connecting the Clavinova to a personal computer, first turn off the power to both the Clavinova and the computer before connecting any cables and setting the HOST SELECT switch. After making connections and switch settings, turn on the power to the computer first, then to the Clavinova.

### TIP

If you are not using the connection between the Clavinova and your computer, you must disconnect the cable from the [TO HOST] jack or [USB] jack. The Clavinova may not operate correctly if a cable is left connected.

### TIP

The connectors that can be used will depend on the setting of the HOST SELECT switch.

#### HOST SELECT switch setting

[MIDI]

[PC-2], [Mac]

[USB]

#### Usable connectors

[MIDI] connectors (all: [IN][OUT][THRU])

[TO HOST] jack

[USB] jack

# 1. Connecting the serial port on the computer to the Clavinova's TO HOST jack

Connect the computer's serial port (RS-232C or RS-422) to the Clavinova's TO HOST jack.

In this connection, the Clavinova functions as a MIDI interface. Therefore, you do not need a special MIDI interface.

---

## Connection

---

Use a special serial cable (page 63) to connect the computer's serial port (RS-232C or RS-422) to the Clavinova's TO HOST jack.

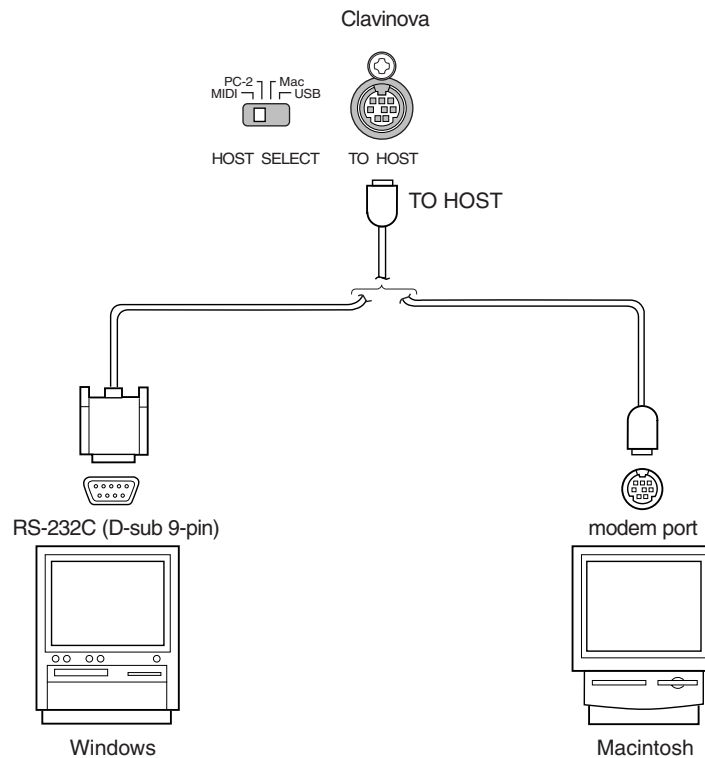

### Note for Windows users (regarding the MIDI driver)

To transfer data via the computer's serial port and the Clavinova's TO HOST jack, you need to install a specific MIDI driver (the Yamaha CBX driver for Windows). You can download this driver from XG Library on the Yamaha Web site (<http://www.yamaha-xg.com>) or install from the Accessory CD-ROM included with the Clavinova.

## Type of serial cables and connection pin assignments

According to the type of computer you connect, use one of the following serial cables.

- **Windows (with a serial port of D-sub 9-pin)**

8-pin mini DIN plug → D-sub 9-pin plug  
(Yamaha CCJ-PC2 or equivalent)

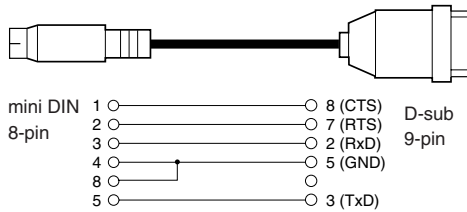

- **Macintosh**

System peripheral plug → 8-pin plug  
(Yamaha CCJ-MAC or equivalent)

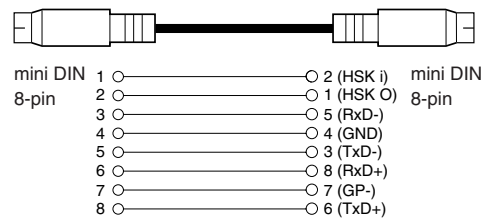

- **Pin assignment**

The following diagram shows the pin assignments for each cable.

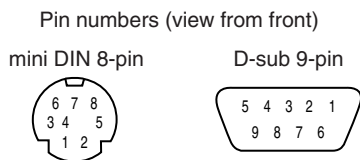

## Clavinova HOST SELECT switch setting

Set the Clavinova HOST SELECT switch properly according to the type of connected computer.

- **Macintosh:** “Mac” (data transfer rate: 31,250bps, 1MHz clock)
- **Windows:** “PC-2” (data transfer rate: 38,400bps)

**TIP**

If your system does not work properly with the connections and settings listed above, your software may require different settings. Check your software operation manual and set the HOST SELECT switch to the proper data transfer rate.

## 2. Using a MIDI interface and the Clavinova's MIDI connectors

---

### Connection

---

Use a MIDI interface device to connect a computer to the Clavinova using special MIDI cables.

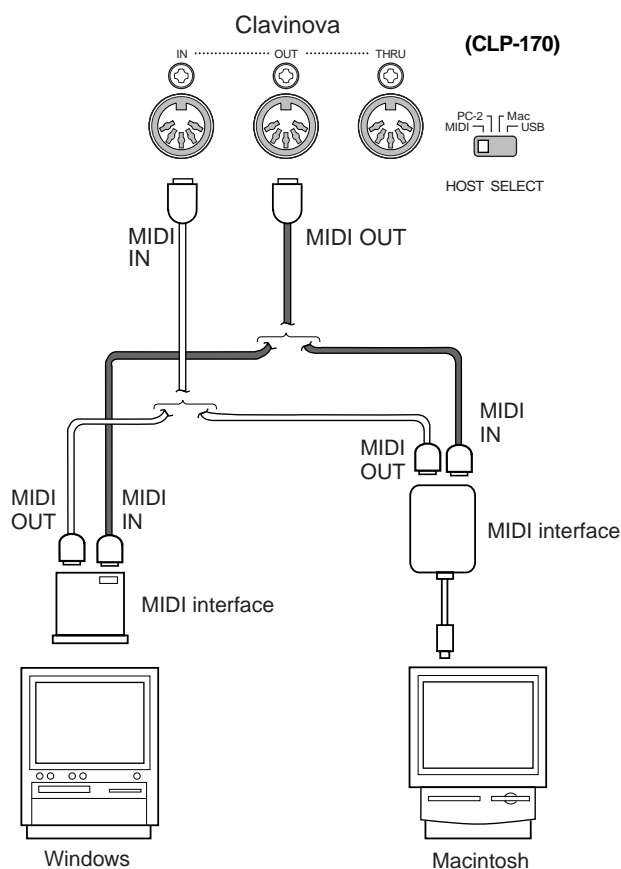

---

### Clavinova HOST SELECT switch setting

---

Set the Clavinova HOST SELECT switch to "MIDI."



### 3. Connecting the USB port on the computer to the Clavinova's USB jack

If you connect the Clavinova to your computer, you can transfer MIDI data between your computer and the Clavinova. You can also use the included File Utility (software for your computer) to transfer files between your computer and the internal memory of the Clavinova.

#### Connections

Use a USB cable to connect the USB port on your computer to the [USB] jack on the Clavinova.

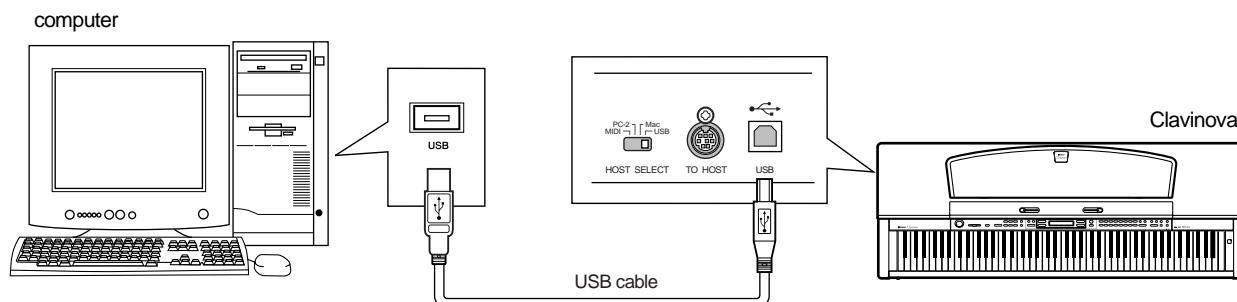

#### TIP

There are two types of USB connectors: A and B. The USB jack on the Clavinova accepts a B-type connector. Connect the A-type connector of the USB cable to the USB port on your computer. Connect the B-type connector to the USB jack on the Clavinova.

---

### Clavinova HOST SELECT switch setting

---

Set the Clavinova HOST SELECT switch to "USB."

#### About the USB driver

You must install the specified USB driver (YAMAHA USB MIDI Driver) in your computer before you can transfer data between the computer and the Clavinova.

The YAMAHA USB MIDI Driver can be installed from the Accessory CD-ROM included with the Clavinova.

The YAMAHA USB MIDI Driver supports the following OS versions.

Windows 98, Windows 98SE, Windows Me, Windows 2000, Windows XP  
Mac OS 8.6–9.2.1

### About the USB connector

- In order to use MIDI on your computer, you will need application software that is appropriate for your computer and that meets your needs.
- If you want to use a USB cable to connect the Clavinova to your computer, you must connect the USB cable before turning on the power of the Clavinova.  
Also, do not turn the power of the Clavinova on or off while application software that uses USB MIDI is running.
- The Clavinova will begin transmission a short time after the USB connection is made.
- When using a USB cable to connect the Clavinova to your computer, make the connection directly without passing through a USB hub.
- Depending on the state of your computer, the operating state of the Clavinova may become unstable. Do not use your computer in a way that causes it to enter an unstable state.

### CAUTION

- If you turn the power of the Clavinova on/off or connect/disconnect the USB cable in the following states, problems will occur in the computer system, possibly causing it to “freeze” (hang up), or causing the Clavinova to stop functioning.
  - While installing the driver
  - While starting-up or shutting-down the operating system
  - While your computer is suspended (sleeping)
  - While a MIDI application is running
- Performing the following actions may cause your computer to hang up or the Clavinova to stop functioning.
  - Rapidly turning the power on/off or connecting/disconnecting the cable
  - Shifting to power-conservation (sleep) mode while MIDI data is being transferred, or returning from sleep mode
  - Connecting/disconnecting the cable while the power of the Clavinova is on
  - Turning the power of the Clavinova on/off, starting up your computer, or installing the driver while a large amount of data is being transferred

# *Detailed Settings*

# Detailed Settings

You can set various parameters to make the best use of Clavinova functions, such as fine tuning the pitch, selecting a voice for the metronome, repeating playback, etc. For the basic procedure to make these settings, refer to page 95.

---

## Parameter List

---

The following parameters are available.

### Recording and playback [SONG SETTING]

Settings	Parameter name	Reference page
Correcting note timing	Quantize	73
Specifying whether playback starts immediately along with the first voicing	QuickPlay	74
Auditioning the channels	ChannelListen	74
Deleting data by each channel	ChannelClear	74
Specifying the range and playing back repeatedly	FromToRepeat	74
Playing back the phrase specified by the phrase number	PhraseMark	75
Playing back a song repeatedly	SongRepeat	75

### Metronome METRONOME [SETTING]

Settings	Parameter name	Reference page
Metronome time signature	TimeSignature	76
Metronome volume level	MetronomeVolume	76
Metronome voice	MetronomeSound	76

**Voices [VOICE SETTING]**

In Dual mode, parameters with the “\*” mark are set for Voice 1 and Voice 2 individually.

Settings	Parameter name	Reference page
Octave*	Octave	78
Volume level*	Volume	78
Position of right and left channels*	Pan	78
Fine pitch adjustment (only in Dual mode)	Detune	78
Reverb type	ReverbType	79
Reverb depth*	ReverbSend	79
Chorus type	ChorusType	79
Chorus depth*	ChorusSend	79
Chorus on/off	ChorusOnOff	80
Select the DSP type*	DSP Type (DSP)	80
Set the speed of the vibraphone vibrato effect*	VibeRotorSpeed	80
Turn the vibraphone vibrato effect on/off*	VibeRotorOnOff (RotorOnOff)	81
Adjust the speed of the rotary speaker*	RotarySpeed (Rot.Speed)	81
Adjust the DSP effect depth*	DSPDepth	81
Adjust the brightness of the sound*	Brightness	81
Adjust the resonance effect*	HarmonicContent (Harmonic)	81
Adjust the low-range frequency of the equalizer*	EQ LowFreq. (EQ L.Freq)	82
Adjust the low-range gain (boost/cut) of the equalizer*	EQ LowGain	82
Adjust the high-range frequency of the equalizer*	EQ HighFreq. (EQ H.Freq)	82
Adjust the high-range gain (boost/cut) of the equalizer*	EQ HighGain	82
Touch sensitivity*	TouchSense	83
Right pedal function	RPedal	83
Center pedal function	MPedal	83
Left pedal function	LPedal	84
Auxiliary pedal function	AuxPedal	84

**iAFC [iAFC SETTING] (CLP-170)**

Settings	Parameter name	Reference page
Select the iAFC type	iAFC Type	85
Adjust the iAFC depth	iAFC Depth	85
Calibrate (automatically adjust) iAFC	Calibration	86
Restore the basic iAFC settings	iAFC Default	86

### MIDI [MIDI SETTING]

Settings	Parameter name	Reference page
MIDI transmit channel	MidiOutChannel	88
Specify the MIDI receive channel	MidiInChannel	88
Local control on/off	LocalControl	89
Selecting performance from the keyboard or song data for MIDI transmission	MidiOutSelect	89
Type of data received via MIDI	ReceiveParameter	89
Type of data transmitted via MIDI	TransmitParameter	89
Song data bulk dump	SongBulkDump	90
Transmitting the initial settings	InitialSetup	90
Voice data bulk dump	VoiceBulkDump	90

### [OTHER SETTING]

Settings	Parameter name	Reference page
Selecting a touch response	TouchResponse	91
Make fine pitch adjustments	Tune	91
Selecting a tuning curve for a piano voice	PianoTuningCurve	91
Selecting a scale	Scale	92
Specifying the Split Point	Split Point	92
Change the key	Transpose	92
Specify the depth of the Soft pedal	SoftPedalDepth	93
Depth of string resonance	StringResonanceDepth	93
Depth of sustain sampling for the damper pedal	SustainSamplingDepth	93
Specify the volume of the key-off sound	KeyOffSamplingDepth	93
Selecting a pedal function for vibraphone	VibraphonePedalMode	93
Assign the SONG [START/STOP] function to the pedal	PedalStart/Srop	94
Selecting a type of auxiliary pedal	AuxPedalType	94
Setting the point at which the damper pedal starts to affect the sound	HalfPedalPoint	94
Pitch bend range	PitchBendRange	94
Switch the speaker on/off	Speaker	95
Selecting the items saved at the time of shutdown	MemoryBackUp	95
Restoring the normal (default) settings	FactorySet	95

## Making detailed settings

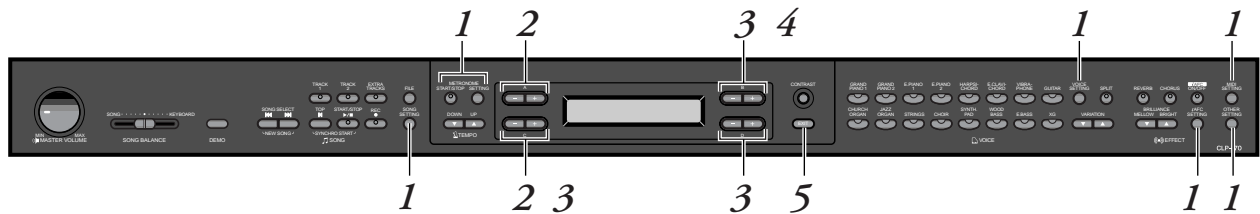

### Procedure

1. **Access a setting menu.**  
 Press the desired setting button ([SONG SETTING], METRONOME [SETTING], [VOICE SETTING], [iAFC SETTING] (CLP-170), [MIDI SETTING], or [OTHER SETTING]) to access the corresponding setting menu.

Press the [EXIT] button any time to close the setting menu.

2. **Select the desired parameter or part.**  
 Press the setting button, A [-]/[+], and/or C [-]/[+] buttons repeatedly as required.

3. **Set the parameter or part.**  
 Some parameters or parts lead you to more options. Use the B [- (NO)]/[+ (YES)], C [-]/[+], and D [-]/[+] buttons to select or set the option.

To restore the normal parameter value, press the [-] and [+] buttons simultaneously.

#### 4. Write, execute, or save the data.

There are two ways to respond to the messages.

##### *If “Execute?→” or “Start?→” appears:*

Press the B [+ (YES)] button to display confirmation ([Sure?→]). To proceed, press the B [+ (YES)] button again. The Clavinova displays “Executing” and writes the data. When the operation is complete, it displays “Completed” for three seconds, then returns to the previous screen.

To cancel the operation, press the B [- (NO)] button instead of the B [+ (YES)] button.



##### *If “Set?→” appears:*

Press the B [+ (YES)] button to execute the setting. The Clavinova displays “Executing” and saves the data. When the operation is complete, it displays “Completed” for three seconds, then returns to the previous screen.

However, the “Completed” display that appears when [Calibration] (page 86) and [VoiceBulkDump] (page 90) is finished will not change back to the previous display after three seconds. Press any button on the panel to return to the previous display.

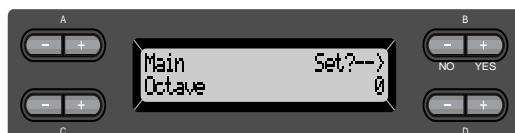

#### 5. Close the setting menu.

Press the [EXIT] button.



# Detailed settings for recording and playback [SONG SETTING]

You can make detailed settings for the selected song. First, select the desired song from preset songs (“Preset-Song”), memory songs (“MemorySong”), or disk songs (“DiskSong”) (CLP-170) (see page 55).

## Procedure

Select the desired song and press the [SONG SETTING] button to access the “Song Setting” menu.

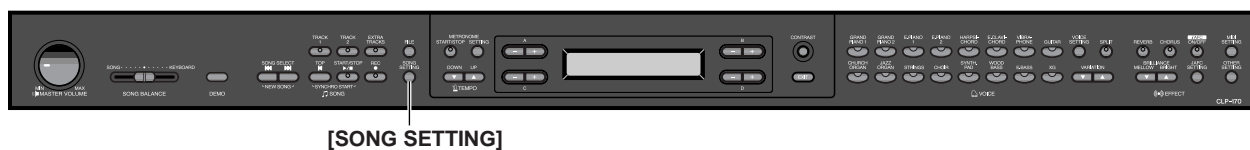

### Correcting note timing [Quantize]

You can correct the timing of notes. For example, you can adjust recorded notes to precise eighth or sixteenth notes, or make the entire feel of a song more lively (with a swing type of rhythm).

- Changes are made by song.
- You can also listen to the sound while changing the setting. To change the data, you need to respond to “Execute?→.”

See the procedure on page 71.

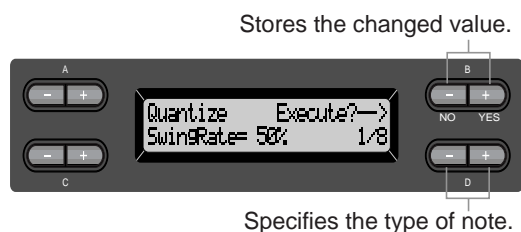

#### Notes for which you can adjust the timing:

##### [OFF]

- [1/4] ..... ♩ quarter note
- [1/8] ..... ♪ eighth note
- [1/12] .... ♪♪ eighth note triplets
- [1/16] .... ♪♪♪ sixteenth note
- [1/24] .... ♪♪♪ sixteenth note triplets

If you select “1/8” or “1/16” for correction, the Clavinova displays “SwingRate=xx%”, which enables you to make the entire feel of a song more lively and swinging.

#### Setting range:

0% - 100%

If you select “1/8” for correction:

#### Performance data

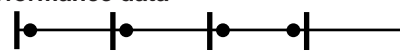

Swing rate = 50% : not swinging

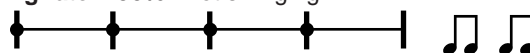

Swing rate = 75% (51% or higher) :

The timing of even beat notes is slightly delayed.

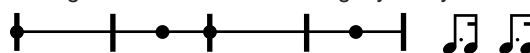

Swing rate = 25% (49% or lower) :

The timing of even beat notes is slightly early.

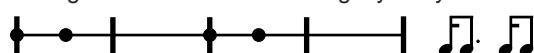

Swing rate = 67% :

The timing of the even beat notes is moved to the third beat of the triplets.

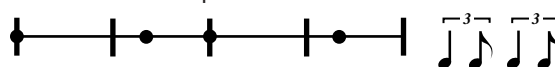

#### TIP

Save the edited song data to memory or (CLP-170 only) a disk. (See page 48.)

### Specifying whether playback starts immediately along with the first voicing [QuickPlay]

This parameter enables you to specify whether a song that starts from the middle of a bar, or a song with a silence prior to the first note, should be played from the first note or from the top of the bar (rest or blank).

See the procedure on page 71.

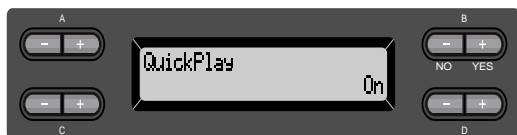

#### Setting range:

[On] Playing from the first note

[Off] Playing from the top of the bar (including a rest or blank)

### Auditioning the channels [ChannelListen]

You can select a single channel to listen to its contents. Playback starts from the first note.

See the procedure on page 71.

Playback continues as long as you press and hold down this button.



Use these buttons to select the desired channel for playback.

#### Setting range:

Ch1 - Ch16

#### TIP

Usually, channels that do not contain any data are not displayed. However, for some songs, all channels (including the channels that contain no data) may be displayed.

### Deleting data from each channel [ChannelClear]

You can delete data from each of 16 channels. See the procedure on page 71.

Press this button to delete data.



Use these buttons to select the desired channel for deletion.

#### Setting range:

Ch1 - Ch16, ALL (all channels)

#### TIP

- Channels that do not contain any data are not displayed. However, for some songs, all channels (including the channels that contain no data) may be displayed.
- Save the edited song data to memory or disk (CLP-170). (See page 48.)

### Specifying the range and playback repeatedly [FromToRepeat]

You can specify a range (in steps of beats) in a song to play back repeatedly.

- Playback repeats after it reaches just prior to the beat specified as the end point.
  - If you start playing back a song with "Repeat On" selected, the count down starts, followed by the repeated playback of the specified part until you press the [TOP] button.
  - If you select "Repeat Off," normal playback starts.
- See the procedure on page 71.

Use these buttons to select "Repeat On."



Use these buttons to specify the start point of the repeated range.

Use these buttons to specify the end point of the repeated range.

**TIP**

Use the following buttons to specify the range to be repeated during song playback.

C [-]/[+] ..... specifies the start point of the repeat.

D [-]/[+] .....specifies the end point of the repeat.

**NOTE**

When you select another song, the specified range is automatically cancelled and the Repeat function is turned off.

**Playing back the phrase specified by the phrase number [PhraseMark]**

If you select a song from an ensemble collection disk, such as the “Disk Orchestra Collection” or one of the “XG for Piano” disks, you can specify phrase numbers in the score to play back from the score from the mark point, or to play back the phrase repeatedly.

- If you start playing back a song with “Repeat On” selected, the count down starts, followed by the repeated playback of the specified phrase until you press the [TOP] button.
- If you select “Repeat Off,” normal playback starts from the specified phrase.

See the procedure on page 71.

Use these buttons to select “Repeat On.”



Use these buttons to specify the phrase number.

**Setting range of the phrase number:**

Off (not specified)

1 - the last phrase number of the song

If you select any song other than those from the “Disk Orchestra Collection” or one of the “XG for Piano” disks, you can select only “Off.”

**Playing back a song repeatedly [SongRepeat]**

You can repeatedly play back all songs or a single song selected from the 50 preset songs or from the floppy disks (CLP-170).

- When you start playback, the Clavinova plays the song you selected using the front panel, then starts repeat playback of the specified songs until you press the [TOP] button.

See the procedure on page 71.

Use these buttons to select “On.”



Use these buttons to specify the repeated songs.

**Setting range:**

- [DiskSongs] All songs in the floppy disk inserted in the disk drive
- [MemorySongs] All songs in the Clavinova’s memory
- [Disk+Memory] All songs from “DiskSongs” and “MemorySongs”
- [PresetSongs] All 50 preset songs
- [ALL] All songs from “DiskSongs,” “MemorySongs,” and “Preset-Songs”
- [OneSong] One song selected from the front panel

# Detailed settings for the metronome METRONOME [SETTING]

You can set the time signature, volume level, and voice of the Clavinova metronome.

## Procedure

Press the [METRONOME SETTING] button to access the Metronome Setting menu.

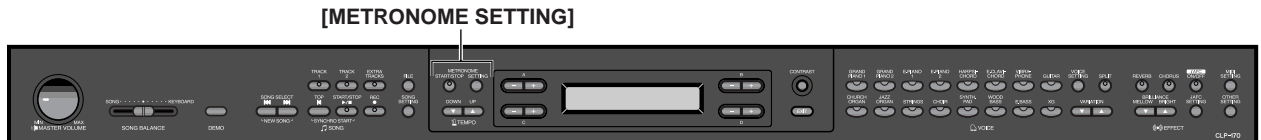

### Setting the metronome time signature [TimeSignature]

See the procedure on page 71.

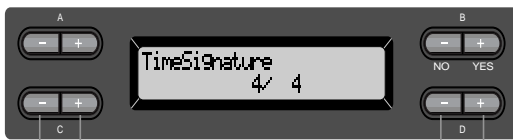

Use these buttons to set the numerator of the time signature.

Use these buttons to set the denominator of the time signature.

For example, to specify “3/4,” use the C [-]/[+] buttons to select “3” and the D [-]/[+] buttons to select “4.”

#### Setting range for the numerator:

1 - 16

#### Setting options for the denominator:

2, 4, and 8

### Setting the metronome volume level [MetronomeVolume]

See the procedure on page 71.



#### Setting range:

0-127

### Selecting the metronome voice [MetronomeSound]

See the procedure on page 71.



#### Setting range:

- [BellOff] Click (standard metronome sound)
- [EnglishVoice] Click and “1, 2, 3, 4” in English
- [GermanVoice] Click and “1, 2, 3, 4” in German
- [JapaneseVoice] Click and “1, 2, 3, 4” in Japanese
- [FrenchVoice] Click and “1, 2, 3, 4” in French
- [SpanishVoice] Click and “1, 2, 3, 4” in Spanish
- [BellOn] Click and bell

#### TIP

To mute the beat count, select “BellOff.”

# Detailed settings for the voices [VOICE SETTING]

This menu enables you to make various detailed settings for the voices in Dual or Split mode and the effects. You can make these settings for each voice (or each combination of voices) individually. You can listen to the notes you play on the keyboard while changing the settings.

## Procedure

1. Select a voice and press the [VOICE SETTING] button to access the “Voice Setting” menu.



2. Press the A [-]/[+] buttons to select the part for which you wish to change the voice.

The range of the displayed part varies depending on the selected voice.

- |                |   |
|----------------|---|
| [Main]         | MAIN voices (displayed with a single voice or in Split mode)            |
| [Main × Layer] | MAIN Voice 1 and Voice 2 (displayed when the MAIN side is in Dual mode) |
| [Left]         | LEFT voice (displayed in Split mode)                                    |
| [Left × Layer] | LEFT Voice 1 and Voice 2 (displayed when the LEFT side is in Dual mode) |

## Detailed settings for the voices [VOICE SETTING]

### TIP

In Dual mode, parameters with the “\*\*” mark are set for Voice 1 and Voice 2 individually.

### TIP

Parameter names enclosed in parentheses ( ) are displayed in Dual mode.

## Setting the octave [Octave]\*

The pitch of a note can be shifted upward or downward in steps of an octave.

See the procedure on page 71.

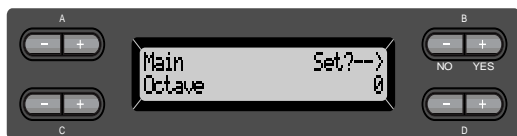

In Dual mode:

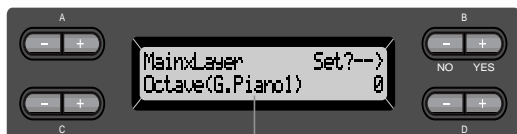

Voice for editing (Voice 1 or Voice 2)

**Setting range:**

-2 (two octaves lower) - 0 (no pitch shift) - +2 (two octaves higher)

## Setting the volume level [Volume]\*

You can set the volume level for each voice part. See the procedure on page 71.

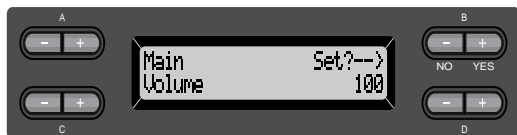

In Dual mode:



Voice for editing (Voice 1 and Voice 2)

**Setting range:**

0 - 127

## Setting the position of right and left channels [Pan]\*

You can specify the position in the stereo image from which you hear the sound.

See the procedure on page 71.

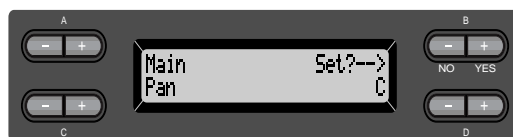

In Dual mode:



Voice for editing (Voice 1 or Voice 2)

**Setting range:**

L64 (hard left) - C (center) - R63 (hard right)

## Make fine adjustments to the pitch (only in Dual mode) [Detune]

The pitch of the two sounds selected in Dual mode can be “skewed” slightly away from each other.

See the procedure on page 71.

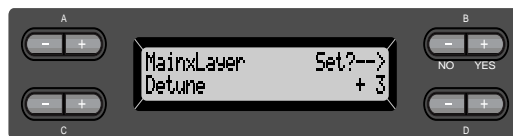

**Setting range:**

-20+20 (Positive (+) settings will raise the pitch of the first sound and lower the pitch of the second sound. Negative (-) settings will do the opposite.)

## Selecting the reverb type [ReverbType]

**TIP**

You cannot set this parameter for the voice parts “Left” and “LeftXLayer.”

See the procedure on page 71.

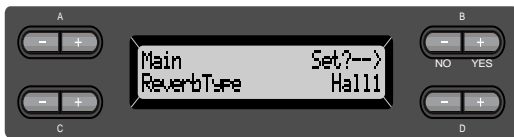

**Setting range:**

- Room Simulates reverberation in a room.
- Hall1 Simulates reverberation in a concert hall.
- Hall2 Reverberation is slightly longer than that of “Hall1.”
- Stage Reverberation suitable for a solo instrument sound.
- Plate Reverberation from the vibration of a metal plate.

## Setting the reverb depth [ReverbSend]\*

**TIP**

The reverb effect is not applied if the ReverbSend parameter is set to “0.”

See the procedure on page 71.



**In Dual mode:**



Voice for editing (Voice 1 or Voice 2)

**Setting range:**

0 - 127

## Selecting the chorus type [Chorus Type]

**TIP**

You cannot set this parameter for the voice parts “Left” and “Left x Layer.”

See the procedure on page 71.



**Setting range:**

- Chorus Adds a rich, spacious sound.
- Celeste Adds swell and a spacious sound.
- Flanger Adds swell effects of an ascending or descending jet plane.

## Setting the chorus depth [ChorusSend]\*

See the procedure on page 71.



**In Dual mode:**

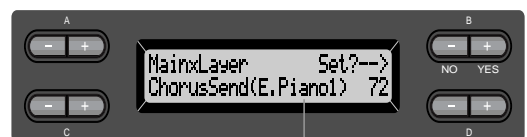

Voice for editing (Voice 1 or Voice 2)

**Setting range:**

0 - 127

### Setting the chorus on/off [ChorusOnOff]

You can set the [CHORUS] button on or off for each voice. When you select a voice, the chorus on/off setting for the voice automatically changes according to this parameter.

**TIP**

Even if this parameter is turned on, the chorus effect is disabled if the ChorusSend parameter is set to 0.

See the procedure on page 71.



**Setting range:**  
On/Off

### Selecting the DSP type\* [DSP Type (DSP)]

You can select other effects (than reverb and chorus).  
See the procedure on page 71.



**Setting range:**

- DelayLCR Delay applied at left, center, and right positions.
- DelayLR Delay applied at left and right positions.
- Echo Echo-like delay
- CrossDelay Left and right delays are crossed.
- Symphonic Adds a rich and deep acoustic effect.
- RotarySpeaker Adds the vibrato effect of a rotary speaker.
- Tremolo The volume level changes in rapid cycles.
- VibeRotor The vibrato effect of a vibraphone.

- AutoPan The sound pans left to right and back and forth.
- Phaser The phase changes periodically, swelling the sound.
- AutoWah The center frequency of the wah filter changes periodically.
- SoundBoardRev Simulates the reverberation of a piano soundboard.
- Off No effect.

### Setting the speed of the vibraphone vibrato effect\* [VibeRotorSpeed]

**TERMINOLOGY**

Rotor= The rotating portion of an electrical device etc.

This will be displayed only if VibeRotor is selected for the DSP Type parameter explained above. This sets the speed of the vibrato effect that is applied when you have selected Vibraphone and are using the VibeRotor pedal.  
See the procedure on page 71.

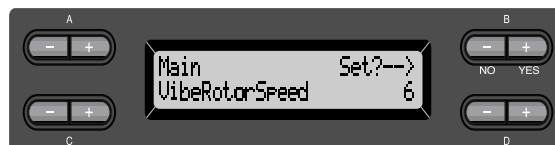

**Setting range:**  
1-10



### Turning the vibraphone vibrato effect on/off\* [VibeRotorOnOff (RotorOnOff)]

This will be displayed only if VibeRotor is selected for the DSP Type parameter explained above. It turns on/off the vibrato effect that is applied when you use the VibeRotor pedal. See the procedure on page 71.



**Setting range:**  
On/Off

### Setting the rotation speed of the rotary speaker\* [RotarySpeed (Rot.Speed)]

This will be displayed only if RotarySpeaker is selected for the DSP Type parameter explained above. It sets the rotation speed of the rotary speaker effect. See the procedure on page 71.



**Setting range:**  
Slow/Fast

### Adjusting the depth of the DSP effect\* [DSPDepth]

This sets the depth of the DSP effect (page 80). Some DSP Type settings do not allow you to set the DSPDepth. See the procedure on page 71.



**Setting range:**  
1 (output only the original sound with almost no effect applied)–127 (output only the sound processed by the effect)

### Adjusting the brightness of the sound\* [Brightness]

See the procedure on page 71.



**Setting range:**  
–64–+63

### Adjusting the resonance effect\* [HarmonicContent (Harmonic)]

See the procedure on page 71.



**Setting range:**  
–64–+63

#### TIP

Resonance can produce a distinctive “peaky” tone, making the sound brighter and harder.

### Adjusting the low-range frequency of the equalizer\* [EQ LowFreq. (EQ L.Freq)]

#### TERMINOLOGY

Equalizer:

An audio equalizer divides the frequency spectrum into multiple regions and enables the user to adjust the relative amplitude of each region.

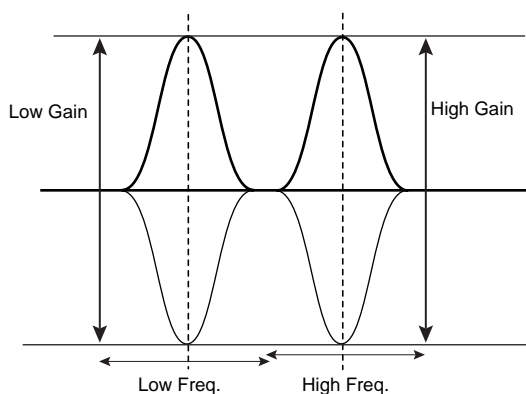

See the procedure on page 71.



**Setting range:**  
32 Hz–2.0 kHz

### Adjusting the low-range gain (amount of boost/cut) of the equalizer\* [EQ LowGain]

See the procedure on page 71.

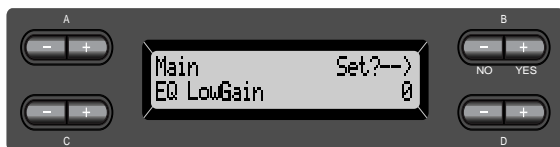

**Setting range:**  
–12–+12 dB

### Adjusting the high-range frequency of the equalizer\* [EQ HighFreq. (EQ H.Freq)]

See the procedure on page 71.



**Setting range:**  
500 Hz–16.0 kHz

### Adjusting the high-range gain (amount of boost/cut) of the equalizer\* [EQ HighGain]

See the procedure on page 71.



**Setting range:**  
–12–+12 dB

## Setting the touch sensitivity [TouchSense]\*

This parameter enables/determines the manner and degree to which the volume level changes in response to your touch on the keyboard (how hard you play). Since the volume level of the harpsichords and pipe organs do not change regardless of how you play the keyboard, the normal setting for these voices is 127. (See the setting range below.) See the procedure on page 71.

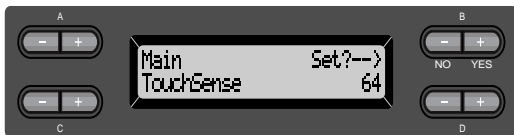

In Dual mode:

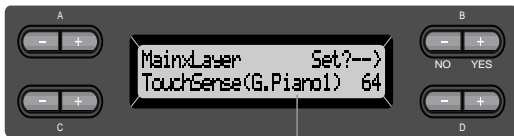

Voice for editing (Voice 1 or Voice 2)

### Setting range:

0 (softest) - 64 (largest changes in the level) - 127 (loudest and fixed)

## Setting the right pedal function [RPedal]

See the procedure on page 71.

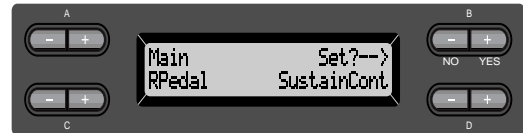

### Setting range:

- Sustain ON/OFF switch type damper
- SustainCont Damper that sustains the sound proportionately to how deeply you press the pedal
- Sostenuto Sostenuto (page 29)
- Soft Soft (page 29)
- Expression A function that lets you create changes in dynamics (volume) as you play
- PitchBend Up A function that smoothly raises the pitch
- PitchBend Down A function that smoothly lowers the pitch
- RotarySpeed Change the rotational speed of the JazzOrgan rotary speaker (switch between fast/slow each time you press the pedal)
- Viberotor Switch the vibraphone vibrato on/off (switch on/off each time you press the pedal)
- Off No function

### Normal setting:

SustainCont

## Setting the center pedal function [MPedal]

See the procedure on page 71.

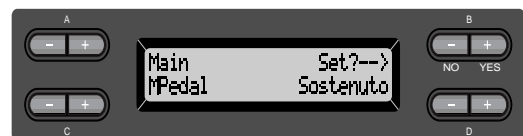

### Setting range:

Same as "Specifying the function of the right pedal," above.

### Normal Setting:

Sostenuto

## Setting the left pedal function [LPedal]

See the procedure on page 71.

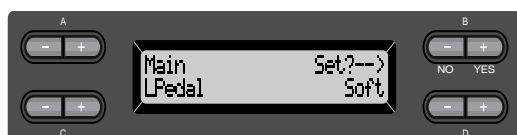

### Setting range:

Same as "Right pedal function assignment" (page 83).

### Normal Setting:

Soft (for all voices other than JazzOrgan and VibraPhone)

Rotary Speed (JazzOrgan), Vibraphone (VibeRotor)

## Setting the auxiliary pedal function [AuxPedal]

You can assign a function to the pedal connected to the Clavinova's AUX PEDAL jack.

See the procedure on page 71.



### Setting range:

Same as "Right pedal function assignment" (page 83).

### Normal setting:

Expression

### TIP

YAMAHA FC7 foot controller

This foot controller is suitable for controlling Expression, SustainCont, or PitchBend Up/Down.

YAMAHA FC4 foot switch

YAMAHA FC5 foot switch

These foot switches are suitable for controlling Sustain, Sostenuto, Soft, RotarySpeed, or VibeRotor.

# Detailed settings for iAFC [iAFC SETTING] (CLP-170)

This section describes how to adjust various iAFC settings, such as selecting the iAFC type and adjusting the depth. You can also perform an automatic adjustment in order to obtain the optimal iAFC effect.

## Procedure

Press [iAFC SETTING] to enter iAFC Setting mode.

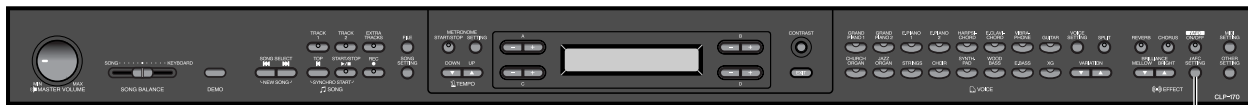

[iAFC SETTING]

### TIP

Perform the automatic adjustment when you turn on the power of the Clavinova for the first time, and also after you have moved the Clavinova. (page 86)

## Selecting the iAFC type [iAFC Type]

See the procedure on page 71.



Select the iAFC type

Select the iAFC variation

### TIP

To understand the character of each iAFC type ... Listen to the demo song for each iAFC type. (page 32)

### Settings:

SpatialEnsEfx (Spatial Ensemble Effect)

This lets you experience the ambience and reverberation that are characteristic of performing on stage. Ambience and reverberation are also added to the performance of the musicians playing together with you, letting you enjoy the sensation of playing together on stage. The sound of the instrument itself and the sound of singing and other instruments played nearby is picked up by a mic, and processed to simulate the spatial characteristic of performing together on stage.

NaturalSndBrd (Natural Soundboard)

This creates the resonance and enhances the acoustic realism of the sound that is characteristic of acoustic instruments. When used on a grand piano sound, it produces a more natural-sounding piano. The sound of the instrument itself is picked up by a mic, and processed to create a virtual soundboard.

DynDmpEfx (Dynamic Damper Effect)

This simulates the sustain sound that occur when you press the damper pedal of a grand piano. The mic is not used, but the sound produced within the Clavinova is processed to create a spacious sensation.

This parameter is effective only on the voice group "GRANDPIANO1."

### Setting range:

DynDmpEfx	GrandPiano, SemiConcert, FullConcert
NaturalSndBrd/SpatialEnsEfx	Small, Medium, Large

### Normal setting:

DynDmpEfx	SemiConcert
NaturalSndBrd/SpatialEnsEfx	Medium

## Adjusting the iAFC depth [iAFC Depth]

See the procedure on page 71.



### Setting range:

0–127

### Normal setting:

106

### TIP

If you select [DynDamEfx] for the iAFC type, lower the Depth value slightly if the rear of the Clavinova is closer to the wall, and raise the Depth value slightly if the rear is far from the wall, to obtain the optimal iAFC effect.

### Calibration (automatic adjustment) [Calibration]

This automatically adjusts the sensitivity and response of iAFC so that the optimal iAFC effect will be obtained.

When automatic adjustment begins, a fairly loud harpsichord note will sound four times at a fixed interval.

Automatic adjustment will end in approximately two and a half minutes.

While automatic adjustment is being performed, do not make audible noises in the vicinity of the Clavinova.

See the procedure on page 71.



#### TIP

iAFC cannot be used in the following cases.

- When the Speaker setting is Normal, and headphones are connected.
- When the Speaker setting is Off.

#### TIP

The keyboard will not produce sound while automatic adjustment is being performed. Nor is it possible to adjust the volume of the Clavinova.

#### TIP

If a sound occurs in the vicinity of the Clavinova during automatic adjustment, the automatic adjustment may be aborted, and the settings reset to their default values. If this occurs, we recommend that you perform the automatic adjustment once again.

#### TIP

If any low-range noise (such as an air conditioner or traffic) is audible around the Clavinova during the automatic adjustment, the adjustment may abort and the settings reset to their default values. If this occurs, we recommend that you perform the automatic adjustment once again after you eliminate the noise.

#### TIP

If you re-locate the Clavinova after making the automatic adjustment, first reset the iAFC settings to their default values before re-locating the unit. (See the following.)

### Restoring the default iAFC settings [iAFC Default]

This sets the iAFC function to the default setting. See the procedure on page 71.



# MIDI [MIDI SETTING]

You can make detailed MIDI settings, such as setting up MIDI transmit/receive channels.

## About MIDI

MIDI (Musical Instrument Digital Interface) is a standard format for data transmission/reception. It enables the transfer of performance data and commands between MIDI devices and personal computers. Using MIDI, you can control a connected MIDI device from the Clavinova, or control the Clavinova from a connected MIDI device or computer.

### MIDI connectors

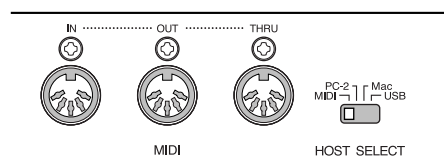

MIDI [IN]: Receives MIDI data.

MIDI [OUT]: Transmits MIDI data.

MIDI [THRU]: Transmits data received at the MIDI [IN] connector as it is.

#### TIP

Prepare dedicated MIDI cables.

### [TO HOST] connector

Use this connector to connect the Clavinova to a computer.

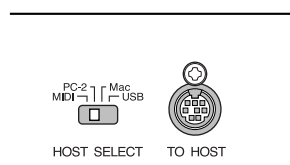

#### TIP

The type connecting cable varies depending on the computer. Refer to "Connecting a Personal Computer" on page 61 for more information.

### [USB] connector

Use this connector to connect the Clavinova and computer.

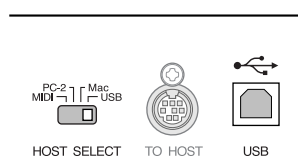

#### TIP

MIDI performance data and commands are transferred in the form of numeric values.

Since MIDI data that can be transmitted or received varies depending on the type of MIDI device, check the "MIDI Implementation Chart" to find out what MIDI data and commands your devices can transmit or receive. The Clavinova's MIDI Implementation Chart is listed on pages 31 and 32 in the "Reference Booklet" for the CLP-170/150.

When you are using the MIDI connectors, set the [HOST SELECT] switch to "MIDI." (See page 59.)

#### TIP

When you are using the [TO HOST] connector, set the [HOST SELECT] switch correctly, according to the type of computer you are using. (See page 59.)

#### NOTE

When you are using the [USB] connector, set the [HOST SELECT] switch to "USB."

#### TIP

You can also obtain detailed information about MIDI from various music magazines and books.

## Procedure

Press the [MIDI SETTING] button to enter MIDI setting mode.



### Setting the MIDI transmit channel [MidiOutChannel]

This parameter enables you to specify the channel on which the Clavinova transmits MIDI data. See the procedure on page 71.



Select a voice part.

Specify the channel.

#### Setting for:

Main, Left, Layer, Left Layer

#### Setting range:

Ch1 - Ch16, Off (Not transmitted.)

#### Normal setting:

Main — Ch1

Left — Ch2

Layer — Ch3

Left Layer — Ch4

### Setting the MIDI receive channel [MidiInChannel]

You can specify whether each channel of data from MIDI [IN], [TO HOST], and [USB] will be received. See the procedure on page 71.

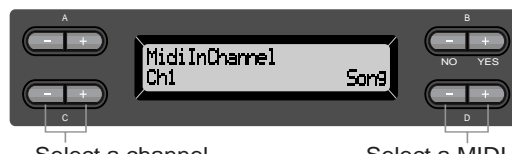

Select a channel.

Select a MIDI receive part.

#### Setting for:

Ch1 - Ch32

#### Setting range:

Song, Main, Left, Layer, LeftLayer, Keyboard, Off

#### Normal setting:

Ch1-16 — Song

Ch17 — Keyboard

Ch18 — Main

Ch19 — Left

Ch20 — Layer

Ch21 — LeftLayer

Others — Off

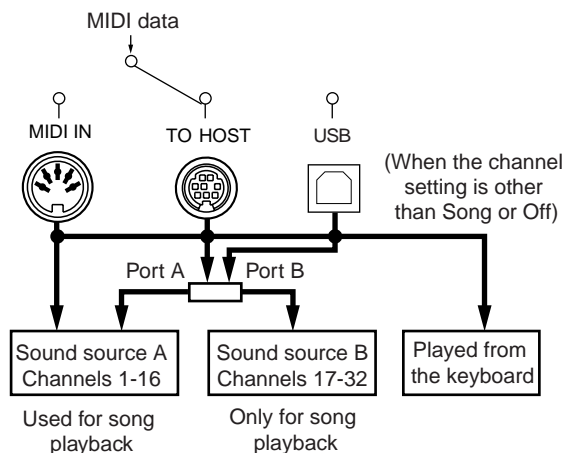



## Setting Local control on/off [LocalControl]

“Local Control On” is a state in which the Clavinova produces the sound from its tone generator when you play the keyboard. In “Local Control Off” state, the keyboard and the tone generator are cut off from each other. This means that even if you play the keyboard, the Clavinova will not produce the sound. Instead, the keyboard data can be transmitted via MIDI to a connected MIDI device, which can produce the sound. The “Local Control Off” setting is useful when you wish to play an external sound source while playing the keys on the Clavinova.

See the procedure on page 71.



### Setting range:

On/Off

### Normal setting:

On

## Selecting performance from the keyboard or song data for MIDI transmission [MidiOutSelect]

You can select whether your performance data or song playback data (including demo songs) is sent via MIDI.

See the procedure on page 71.



### Setting range:

Keyboard performance data played on the keyboard

Song song playback data

### Normal setting:

Keyboard

## Selecting a type of data received via MIDI [ReceiveParameter]

This parameter enables you to specify which MIDI data the Clavinova can receive.

See the procedure on page 71.

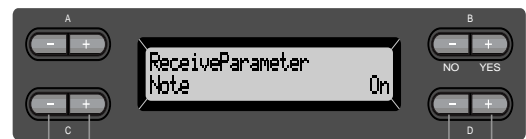

Select a type of data.

Select On or Off.

### Type of data:

Note, Control, Program, Pitch Bend, SysEx (System Exclusive)

### Setting range:

On/Off

### Normal setting:

On for all types of data

## Selecting a type of data transmitted via MIDI [TransmitParameter]

This parameter enables you to specify which MIDI data the Clavinova can transmit.

See the procedure on page 71.



Select a type of data.

Select On or Off.

### Type of data:

Note, Control, Program, Pitch Bend, SystemReal-Time, SysEx (System Exclusive)

### Setting range:

On/Off

### Normal setting:

On for all types of data

### Transmitting the initial settings on the panel [InitialSetup]

You can transmit the panel data, such as voice selection, to a connected sequencer. Before you record performance data to a connected MDF3 or sequencer, it is useful if you first send and record (at the beginning of the performance data) the panel setup data for your performance during playback.

See the procedure on page 71.



### Executing voice data bulk dump [VoiceBulkDump]

You can transmit the voice data specified in the “Voice Setting” menu (page 77) as MIDI bulk data. You can interrupt voice data bulk dump transmission by pressing the B [- (NO)] button.

See the procedure on page 71.



# Other settings

You can make detailed settings for touch, tuning, scale, etc.

## Procedure

Press the [OTHER SETTING] button to enter Other Setting mode.



[OTHER SETTING]

### Selecting a touch response [TouchResponse]

You can specify a touch response (how the sound responds to the way you play the keys). See the procedure on page 71.



#### Setting range:

- Light** With a soft touch, the Clavinova produces a loud sound. The volume level of tones tends to be consistent.
- Medium** Standard touch response.
- Heavy** You must hit the key very hard to generate a loud volume. This allows for versatile expression, from pianissimo to fortissimo tones.
- Fixed** No touch response. The volume level will be the same regardless of how hard you play the keys. Use the B [-]/[+] buttons to set the volume level.

#### Setting range of the "Fixed" volume level:

1 - 127

### Fine tuning the pitch [Tune]

You can fine tune the pitch of the entire instrument. This function is useful when you play the Clavinova along with other instruments or CD music.

See the procedure on page 71.



#### Setting range:

A3=427.0Hz - 453.0Hz (0.1Hz steps)

### Selecting a tuning curve for a piano voice [PianoTuningCurve]

You can select a tuning curve from "GrandPiano1" and "GrandPiano2." Select "Flat" if you feel the tuning curve of the piano voice does not quite match that of other instruments voices.

See the procedure on page 71.

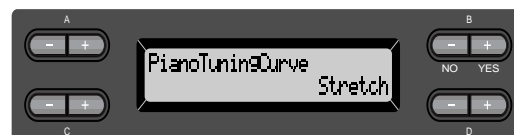

#### Setting range:

- Stretch** Tuning curve particularly for pianos
- Flat** Tuning curve in which the frequency is octave doubled over the entire keyboard range

## Selecting a scale [Scale]

You can select various scales. Equal Temperament is the most common contemporary piano tuning scale. However, history has known numerous other scales, many of which serve as the basis for certain genres of music. You can experience the tunings of these genres. See the procedure on page 71.

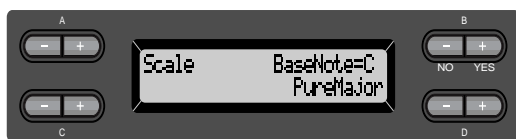

### Setting range:

Equal

One octave is divided into twelve equal intervals. Currently most popular piano tuning scale.

PureMajor/PureMinor

Based on natural overtones, three major chords using these scales produce a beautiful, pure sound. They are sometimes used for chorus parts.

Pythagorean

This scale, designed by Pythagoras, a Greek philosopher, is based on the interval of a perfect 5th. The 3rd produces swells, but the 4th and 5th are beautiful and suitable for some leads.

MeanTone

This scale is an improvement of the Pythagorean in that the swell of the 3rd has been eliminated. It spread during the late 16th century through the late 18th century. Handel used this scale.

WerckMeister/KirnBerger

These scales combine Mean Tone and Pythagorean in different ways. With these scales, modulation changes the impression and feel of the songs. They were often used in the era of Bach and Beethoven. They are also often used now to reproduce the music of that era on harpsichords.

### Normal setting:

Equal

If you select a scale other than Equal, you need to specify the root note using the B [-]/[+] buttons.



### Setting range:

C, C<sup>♯</sup>, D, E<sup>b</sup>, E, F, F<sup>♯</sup>, G, A<sup>b</sup>, A, B<sup>b</sup>, B

## Specifying the Split Point [Split Point]

You can specify the split point (the boundary between the right-hand and left-hand keyboard areas). See the procedure on page 71.



### Setting range:

A-1-C7

### NOTE

You can also use [SPLIT] to set the split point. (page 36)

## Changing the key [Transpose]

### TIP

TRANSCOPE= To change the key

(Changing the key: To raise or lower the overall pitch of the entire song.)

The Clavinova's Transpose function makes it possible to shift the pitch of the entire keyboard up or down in semi-tone intervals to facilitate playing in difficult key signatures, and to let you easily match the pitch of the keyboard to the range of a singer or other instruments. For example, if you set the transposition amount to "5," playing key C produces pitch F. In this way, you can play the song as if it were in C major, and the Clavinova will transpose it to the key of F.



### Setting for:

- Master The sound of the entire instrument (the manually-played sound and the song playback)
- Keyboard The manually-played sound
- Song The song playback

**Setting range:**

-12 (-1 octave)-0 (normal pitch)-+12 (+1 octave)

**Adjusting the depth of the Soft pedal [SoftPedalDepth]**

See the procedure on page 71.

**Setting range:**

1-10

**Depth of string resonance [StringResonanceDepth]**

This parameter is effective on the voices, such as "Grand Piano 1."

See the procedure on page 71.

**Setting range:**

Off, 1 - 10

**Depth of sustain sampling for the damper pedal [SustainSamplingDepth]**

This parameter is effective only on the voice group "GRANDPIANO1."

See the procedure on page 71.

**Setting range:**

Off, 1 - 10

**Specify the volume of the key-off sound [KeyOffSamplingDepth]**

You can adjust the volume of the key-off sound (the subtle sound that occurs when you release a key) This is effective on the voice groups "Grand Piano1," "Harpichord," and "E.Clavichord" and on the voice "E.Piano2."

See the procedure on page 71.

**Setting range:**

Off, 1 - 10

**Selecting a pedal function for vibraphone [VibraphonePedalMode]**

This parameter enables you to select whether the sound is sustained while you press the keys on the keyboard ("PianoLike") or the sound is sustained only while you press and hold down the sustain pedal, like playing a real vibraphone ("Normal"). See the procedure on page 71.

**Setting range:**

PianoLike, Normal

**Normal setting:**

PianoLike

## Assign the SONG [START/STOP] function to the pedal [PedalStart/Stop]

### TIP

If you assign the SONG START/STOP function to a pedal and turn the function On, the pedal function assigned to the pedal in the Voice Setting menu (pages 83 and 84) is disabled.

See the procedure on page 71.



Select a pedal to assign the function.

Set to On or Off.

### Setting for:

Left, Middle, AUX

### Setting range:

On/Off

### Normal setting:

Off for all pedals

## Selecting a type of auxiliary pedal [AuxPedalType]

A pedal connected to the [AUX PEDAL] connector may switch on and off differently. For example, some pedals turn on the effects and others turn them off when you press them.

Use this parameter to reverse this mechanism.

See the procedure on page 71.



### Setting range:

Make, Break

## Setting the point at which the damper pedal starts to affect the sound [HalfPedalPoint]

Here you can specify the point to which you must depress the pedal (right, center, left, AUX) before the assigned effect begins to be applied. (This setting applies to effects that can be assigned to each pedal, such as damper or sostenuto (page 83). Expression is not affected by this setting.)

If the effect is an on/off type effect, this setting specifies the point at which the effect will be switched on/off.



### Setting range:

-2 (effective with the shallowest press) - 0 - +2 (effective with the deepest press)

## Pitch bend range [PitchBendRange]

This specifies the amount of change that can be produced by the pitch bend function which smoothly varies the pitch.

- This setting applies only to the manually-played sound.
- This setting can be made in semitone steps.
- You can set the pedal function (page 83) to specify whether the pitch will be raised or lowered.

See the procedure on page 71.



### Setting range:

0→+12 (Pressing the pedal will raise/lower the pitch by 12 semitones [1 octave])

### Normal setting:

-2

## Switch the speaker on/off [Speaker]

This setting lets you switch the speaker on/off. See the procedure on page 71.

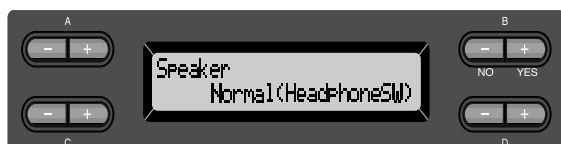

Normal (HeadphoneSW)

The speaker will sound only if headphones are not connected.

On The speaker will always sound.

Off The speaker will not sound.

## Selecting items saved at shut-down [MemoryBackUp]

You can back up some settings, such as voice selection and metronome setting, so that they will not be lost after you turn off the power to the Clavinova.

- Memory songs (saved in the Clavinova's memory), the backup on/off setting (this parameter setting), and the "CharacterCode" parameter setting (page 54) are always backed up.

See the procedure on page 71.



Select the desired item.

Select on or off.

### Setting for:

Transpose, Brilliance, ReverbOnOff, iAfcOnOff (CLP-170), SplitPoint, Main/LeftVoice, MetronomeSetting, SongSetting, iAfcSetting (CLP-170), MidiSetting, and OtherSetting (except for Transpose and SplitPoint setting).

### Setting range:

On/Off

### Normal setting:

The Transpose, Main/LeftVoice, MetronomeSetting, and OtherSetting (except for Transpose and SplitPoint setting) parameters are set to Off. Other parameters are set to On.

## Restoring the normal (default) settings [FactorySet]

You can reset the Clavinova to its normal (factory default) settings.

- The CharacterCode parameter setting in the File menu does not change.
- The MemoryBackUp parameter setting (On/Off) (left column) is reset to the normal setting.
- You can specify whether the memory songs are erased or kept.

See the procedure on page 71.

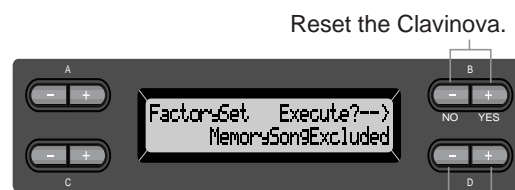

Reset the Clavinova.

Select a value for memory songs.

### Selecting for "MemorySong":

MemorySongExcluded Memory songs are kept.

MemorySongIncluded Memory songs are erased.





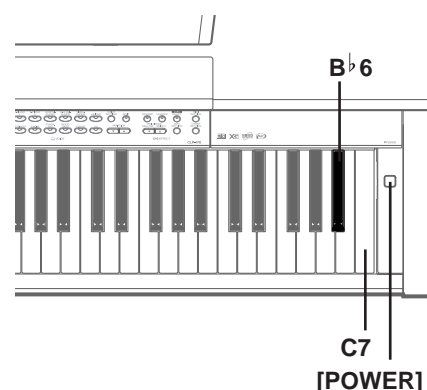



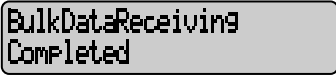

## Other method for restoring the normal settings

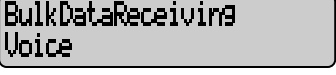
Press and hold down the white key on the right end (C7) and press the [POWER] switch to turn on the power to the Clavinova. In this case, the Memory songs saved in the storage memory are not erased. If you wish to erase Memory songs at this time, press and hold down the right-most white key (C7) and black key (B<sup>b</sup>6) and press the [POWER] switch to turn on the power to the Clavinova.



# Message List

The messages are listed in alphabetical order.

Message	Meaning
	This will be displayed following the “BulkDataReceiving Voice” message. This indicates that the Clavinova finished receiving the bulk data. Once you have verified this message, you may proceed to the next step.
	Receiving bulk data has failed. Check the parameter settings and try again.
	The Clavinova is receiving the voice setting bulk data while this message is displayed. Wait until the message disappears, then proceed to the next step.
(CLP-170) 	This message will appear if a sound is audible in the vicinity of the Clavinova during automatic adjustment. The automatic adjustment may abort, and the settings reset to their default values. In this case, perform the automatic adjustment once again.
(CLP-170) 	This message means that when the “Speaker” setting is set to Normal and headphones are connected, no sound is output from the rear speaker, and therefore automatic adjustment of iAFC is not possible. In this case, unplug the headphones.
(CLP-170) 	This message means that automatic adjustment of iAFC is not possible because no sound is output from the rear speaker. In this case if the “Speaker” setting is Off, turn “Speaker” On. If “Speaker” is set to Normal and headphones are connected, unplug the headphones.
	This message confirms that in the “VoiceBulkDump” operation (page 90), you pressed B [-(NO)] to cancel while data was being transmitted.
	This message is displayed following the message “Executing.” The Clavinova’s internal processing is complete. You may proceed to the next step.
(CLP-170) 	When you delete a folder, this message asks you whether you want to delete all of the files in that folder. To delete all files in the folder, press the D [+ (YES)] button. To cancel, press the D [-(NO)] button.
(CLP-170) 	Writing or reading data from the disk has failed. Try again. If you still see this message, the disk may be damaged or the disk drive may have malfunction. If you see this message while using a brand new disk, it is more likely that the disk drive is malfunctioning. Ask your Yamaha dealer for repair.
(CLP-170) 	The floppy disk space is full and can no longer record data. Use a new disk (page 48) or delete unnecessary files from the disk (page 49) to make room for new data.



Message	Meaning
(CLP-170) DiskRemoved	You attempted to eject a floppy disk from the disk drive while the drive was writing or reading. The writing or reading operation is not complete yet. Try it again.
DuplicateName	When you attempted to rename a song and save it in “RenameSong” (page 51), this message will appear if an identically-named song already exists in the save memory / floppy disk that contains that song. Three seconds after this message is displayed, you will return to the previous screen. Please specify a different name.
Execute?→	This message prompts you to execute a file-related operation. Press the B [+ (YES)] button to proceed, or press the [EXIT] button to cancel.
Executing	The Clavinova is processing the data internally. Wait until the message disappears, then proceed to the next step.
FactorySet Completed MemorySongExcluded	The normal (factory default) settings (except for the memory song setting) (“FactorySet” on page 95) have been restored. This message also appears if you press and hold down the C7 key and turn on the power to the Clavinova (page 95).
FactorySet Completed MemorySongIncluded	The normal (factory default) settings (including the memory song setting) (“FactorySet” on page 95) have been restored. This message also appears if you press and hold down the C7 and B <sup>b</sup> 6 keys and turn on the power to the Clavinova (page 95).
FlashMemoryLifeTime Exit→	The Clavinova’s flash memory (storage memory) has expired. Consult your Yamaha dealer. If this message appears, the Clavinova will not back up the songs and settings in memory. Press the [EXIT] button to return to the previous screen.
HostError	<p>There is a problem with the TO HOST/USB connector</p> <p><b>When using the CLP-170/150 connected to your personal computer ...</b> The driver or MIDI application on your computer is not functioning correctly, perhaps because the computer is turned off, the cable is not connected correctly, or the HOST SELECT switch is not set correctly. In this case, turn off the power of the CLP-170/150 and your computer, and check the cable connections and HOST SELECT switch setting. Then turn on the power in the order of your computer → CLP-170/150, and check that the driver and MIDI application on your computer are functioning correctly.</p> <p><b>When using the CLP-170/150 by itself ...</b> This message may appear if a cable is left connected to the [TO HOST] or [USB] connector of the CLP-170/150. In this case, turn off the power of the CLP-170/150, disconnect the cable, and then turn on the power again. If the cable is left connected, the CLP-170/150 may not function correctly.</p>

## Message List

Message	Meaning
(CLP-170) InsrtSourceDisk	In the CopyDisk operation (page 52), the copy source disk has not been inserted to the disk drive. Insert the disk.
(CLP-170) InsrtTargetDisk	In the CopyDisk operation (page 52), the copy destination disk has not been inserted into the disk drive. Insert the disk.
LastPowerOffIllegal MemorySongChecking	You turned off the power to the Clavinova while it was writing a song to storage memory. This message appears next time you turn on the power. The Clavinova checks if the contents of storage memory can be recovered.
LastPowerOffIllegal MemorySongErrorRecovered	This message appears following the message “LastPowerOffIllegalMemorySongChecking,” indicating that the Clavinova recovered data in the storage memory as much as possible.
LastPowerOffIllegal MemorySongErased	This message appears following the message “LastPowerOffIllegalMemorySongChecking,” indicating that the Clavinova could not recover data in the storage memory and that all memory songs were deleted.
MemoryError	While a preset song was being read, the Clavinova detected defects in memory. Reset the Clavinova to its normal (factory default) settings with “MemorySongIncluded” (page 95) after you back up all song data.
MemoryError	This message indicates that there may be a problem with the memory. If the message appears repeatedly when you continue using the Clavinova, back up the song data, then restore the default setting by using “FactorySet” with “MemorySongIncluded” selected (page 95).
MemoryFull	There is not enough memory space left and you cannot save any more songs. Save songs to a floppy disk (page 52) or delete some songs in the storage memory, then save new data to memory.
(CLP-170) NoDisk	A floppy disk has not been inserted into the disk drive for a disk-related operation. Insert the disk and continue.
NoSong	This message will appear if there is no song for the “SaveToMemory” (page 48) or “SaveToDisk” (CLP-170) (page 49) operation to save. In this case, no song will be saved.
NoSongsToDelete	You tried to delete a song that does not exist in the storage memory or on disk. You cannot delete the song.

Message	Meaning
<div style="border: 1px solid black; padding: 5px; text-align: center;">OverWrite?</div>	<p>This message prompts you to select whether you wish to overwrite the existing data with new data when you add recordings to a song. Press the B [+ (YES)] button to allow overwriting. Press the B [- (NO)] button to cancel.</p>
<div style="border: 1px solid black; padding: 5px; text-align: center;">PleaseWait</div>	<p>You tried to start playing a song or perform another operation right after you select the song. Wait until the message disappears.</p>
<p>(CLP-170)</p> <div style="border: 1px solid black; padding: 5px; text-align: center;">ProtectedDisk</div>	<ol style="list-style-type: none"> <li>1. You tried to write, copy, or delete data on a disk that has its “write protect” tab on, or a disk that is internally protected against writing. Set the protect tab to off (unprotected) (page 13) and try again. If you still see this message, the disk is internally protected (such as commercially available music data). You cannot write or copy to such a disk.</li> <li>2. This message also appears when you try to copy data on an internally-protected disk onto another disk using the CopyDisk function (page 52). You cannot duplicate such a disk.</li> </ol>
<div style="border: 1px solid black; padding: 5px; text-align: center;">ProtectedFile</div>	<p>You tried to copy or delete data in internally-protected files (such as commercially available music data). You cannot write to, copy, or delete such files.</p>
<div style="border: 1px solid black; padding: 5px; text-align: center;">ProtectedSong</div>	<p>After you load an internally-protected song into the Clavinova’s Current memory or storage memory, you tried to save the song to a floppy disk. You cannot save such a song to another disk. You cannot write or copy to such a disk.</p>
<div style="border: 1px solid black; padding: 5px; text-align: center;">Set?—&gt;</div>	<p>This message prompts you to select whether you wish to save the edited settings. Press the B [+ (YES)] button to save the settings. Press the [EXIT] button to cancel.</p>
<div style="border: 1px solid black; padding: 5px; text-align: center;">SongChanged Save?</div>	<p>You tried to perform another operation before saving the recorded song to storage memory or a floppy disk. If you continue the operation, the recorded song will be lost. To delete the new recording, press the B [- (NO)] button. To keep the recording, press the B [+ (YES)] button. The Clavinova displays the “SaveToMemory” (page 48) or “SaveToDisk” (CLP-170) (page 49) parameter screen. If necessary, select “SaveToMemory” or “SaveToDisk” accordingly and save the recorded song, then proceed to another operation.</p>

Message	Meaning
<code>SongError</code>	<ol style="list-style-type: none"> <li>1. This message will appear if a problem is found with the song data when you select a song or while the song is playing. In this case, re-select the song, and try once again to play it back. If the message still appears, the song data may have been damaged.</li> <li>2. This message will appear if a different “CharacterCode” (page 54) is selected than when you assigned the song name. In this case, switch the “CharacterCode”, re-select the song, and play back.</li> </ol>
<code>SongTooBig</code>	<ol style="list-style-type: none"> <li>1. This message will be displayed if current memory fills up during recording. Recording will stop automatically at this point. The data that had been recorded up to that point will remain. This message will also be displayed when you attempt to enter Record mode for additional recording if that song already occupies all of current memory. In this case, additional recording will not be possible. If there is an already-recorded track that you do not need to keep, you can use “ChannelClear” (page 74) to delete the unneeded track, so that you will then be able to record the equivalent amount of additional material.</li> <li>2. This message will be displayed when you select a song if that song is larger than the capacity of the current memory (page 102). This song cannot be loaded into the CLP-170/150, and cannot be played back. Please select a different song.</li> </ol>
<code>SongTooBig</code>	This message will be displayed when you edit a song if that song is larger than the capacity of the current memory (page 102). This song cannot be edited on the CLP-170/150.
<code>Start?--&gt;</code>	This message prompts you to start the operation. To start, press the B [+ (YES)] button. Press the [EXIT] button to cancel the operation.
<code>Sure?--&gt;</code>	This message prompts you to confirm the execution. Press the B [+ (YES)] button to continue. Press the B [- (NO)] button to cancel.
(CLP-170) <code>UnformattedDisk</code>	You tried to perform a file- or disk-related operation using an unformatted disk. Eject the disk, format it using the “FormatDisk” parameter (page 53), and try again.
(CLP-170) <code>UnformattedDisk Format?</code>	You tried to perform a file- or disk-related operation using an unformatted disk. To cancel the operation, press the B [- (NO)] button. To format the disk and try again, press the B [+ (YES)] button to display the “FormatDisk” parameter (page 53).

Message	Meaning
VoiceBulkDump Error	This message means that the Clavinova was unable to transmit voice bulk data. If this message appears, make sure that the power of your computer is not turned off, that the cable is connected correctly, that the HOST SELECT switch is set correctly, and that the driver on your computer is functioning correctly. Then try transmitting the data once again.
(CLP-170) WrongDisk	You tried to copy data to a different type of disk (e.x.: 2DD→2HD, 2HD→2DD) during the CopyDisk operation (page 52). Eject the disk and insert an appropriate disk.
WrongName	You used a period or space at the beginning of a song name or you tried to change a song name that includes a character (or characters) not supported by the CLP-170/150, and the CLP-170/150 could not process the name. The Clavinova displays the previous screen in three seconds. Rename the song correctly.

# Questions about Operations and Functions

## ■ The buttons do not respond.

While you are using a function, some buttons not used for the function are disabled. If the song is playing, stop the playback. Otherwise, press the [EXIT] button to return to the main screen. Then, perform the desired operation.

## ■ The sound sustains and does not decay when I press the sostenuto pedal.

With the voices in the CHURCH ORGAN, JAZZ ORGAN, STRINGS, CHOIR group, or some voices in the XG group, the sound continues sustaining while you are holding down the sostenuto pedal.

## ■ Higher or lower notes does not sound correctly when the transpose or octave setting is made.

The setting range for the transposition and octave setting is C-2 - G8. (With the normal setting, the Clavinova's 88 keys covers the range of A-1 - C7.) If the lowest key is set to a note lower than C-2, it will produce a sound one octave higher. If the highest key is set to a note higher than G8, it will produce a sound one octave lower.

## ■ How can I return to the recording or song select screen during song recording or playback?

Press one of the SONG SELECT [◀◀] and [▶▶] buttons once.

## ■ The tempo does not change even though I recorded with tempo changes.

Depending on the timing of tempo changes, the changed tempo may not be recorded. In this case, the recording will be played back at the original tempo.

Make tempo changes when the recording track is selected and a red track indicator is flashing. The same trick applies to editing the tempo after recording.

## ■ Performance in Dual or Split mode is not recorded.

### Track data is lost unexpectedly.

For Dual or Split mode recording, the recording track for the second voice (that is, the voice for the left-hand part) is automatically assigned (page 33). Therefore, if the track already has data, the data will be overwritten during recording. Also, switching to Dual mode or Split mode in the middle of the song is not recorded. Therefore, the notes you played with the second voice (or the notes lower than the Split point) are not recorded.

## ■ What type of data is recorded?

### Data recorded in the tracks:

- Note data (notes you play)
- Voice selection
- Clavinova pedals and external pedal on/off
- Reverb depth [ReverbSend]
- Chorus depth [ChorusSend]
- DSP effect depth [DSPDepth]
- Sound brightness [Brightness]
- Resonance effect setting [Harmonic Content]
- Equalizer's low-range frequency setting [EQLowFreq.]
- Equalizer's low-range gain setting [EQLowGain]
- Equalizer's high-range frequency setting [EQHighFreq.]
- Equalizer's high-range gain setting [EQHighGain]
- Octave setting of the voice [Octave]
- Volume setting of each voice [Volume]
- Left/right position of each sound [Pan]
- Fine pitch adjustment between two voices (Dual only) [Detune]
- Volume change in response to playing strength for each voice [TouchSense]

### Data recorded globally in all tracks:

- Tempo
- Time signature
- Reverb type
- Chorus type
- DSP effect type

*You can change all data except for note data after recording.*

*You can change the time signature at the beginning of the song, or at a position in the song to which you move, by using the B [-]/[+] buttons while the song is stopped.*

■ **I cannot change the key signature in the song after recording.**

Press the [TOP] button to locate the top of the song, use the B [-]/[+] buttons to locate the measure in which you wish to change the key signature, then change it.

■ **How much data can I record?**

- Current memory (page 48): About 800KB
- Storage memory (page 48): About 750KB
- 2DD floppy disk (CLP-170) (page 12): about 720KB
- 2HD floppy disk (CLP-170) (page 12): about 1.4MB

■ **The on/off setting of the pedal connected to the AUX PEDAL jack is reversed.**

Some types of pedals may turn on and off in opposite fashion. Use the "AuxPedalType" parameter (page 84) in the "OTHER SETTING" menu to change the external pedal setting.

■ **The song title is not correct.**

The "CharacterCode" setting may be different than that used when you named the song. Also, if the song was recorded on another instrument, the title might be displayed incorrectly. Use the "CharacterCode" parameter (page 54) in the FILE menu to change the setting. However, if the song was recorded on another instrument, changing the "CharacterCode" parameter setting may not resolve the problem.

■ **What is the difference between "TouchSense" and "TouchResponse" MIDI data?**

"TouchSense" determines the manner and degree to which the volume level changes in response to your touch on the keyboard. The MIDI note-on velocity data is not changed. It changes the volume level at the same velocity data.

"TouchResponse" determines the touch sensitivity of an instrument. The MIDI note-on velocity data is changed when you play the keyboard with a consistent touch.

**MEMO**



# *Appendix*

# Troubleshooting

Problem	Cause	Solution
The power of the Clavinova does not turn on.	The power cable is not plugged in (check at the Clavinova and at the electrical outlet).	Insert the power cable plug firmly into the Clavinova and into the electrical outlet of the correct voltage. (page 17)
There is a clicking noise when you press [POWER] to turn the power on or off.	This is caused by the electrical power within the instrument.	This is not a malfunction.
Noise is heard from the Clavinova.	A portable telephone is being used near the Clavinova (or the ring tone is sounding).	Turn off the power of the portable telephone located near the Clavinova. Noise may be heard if a portable telephone is used near the Clavinova or if the ring tone occurs.
The overall volume is too low. Or, there is no sound at all.	The [MASTER VOLUME] is lowered.	Raise [MASTER VOLUME]. (page 18)
	Headphones are connected (only if the Speaker setting is "Normal HeadphoneSW"). (page 95)	Disconnect the headphone plug.
	Speaker setting is off.	Set [Speaker] to "Normal" or "ON". (page 95)
	Local Control is turned off.	Set Local control ON. (page 89)
"Expression" is assigned to one of the right, center, and left pedals.		Assign any function other than "Expression" to the pedal.
The keyboard volume is lower than the song playback volume.	The volume level for the keyboard performance is set too low.	Move [SONG BALANCE] toward the keyboard to increase the keyboard volume.
Sound is still heard from the speakers even though headphones are plugged in.	Speaker setting is On.	Set the speaker setting to "Normal (HeadphoneSW)". (page 95)
iAFC is not effective when it is turned ON.	The iAFC mic cords are not inserted into the jacks firmly.	Insert the iAFC mic cords firmly into the jacks. (page 116)
Feedback occurs when you turn iAFC on. (CLP-170)	iAFC was not automatically adjusted correctly.	Turn iAFC OFF, and perform the automatic adjustment (page 86).
Damper pedal does not function, or notes are sustained even though the damper pedal is not pressed.	The plug of the pedal cable is not inserted into the [PEDAL] jack.	Plug the pedal cable firmly into the [PEDAL] jack. (Refer to "CLP-150: Keyboard Stand Assembly" beginning on page 112, or "CLP-170: Keyboard Stand Assembly" on page 115.)

# Data Compatibility

This section covers basic information on data compatibility: whether or not other MIDI devices can playback the data recorded by CLP-170/150, and whether or not the CLP-170/150 can playback commercially available song data or song data created for other instruments or on a computer.

Depending on the MIDI device or data characteristics, you may be able to play back the data without any problem, or you may have to perform some special operations before the data can be played back. If you run into problems playing back data, please refer to the information below.

---

## Basic Check Points

---

The data and the MIDI device must match in regards to the items below.

- Disk Format (CLP-170)
- Sequence format
- Voice allocation format

---

## Disk format (CLP-170)

---

Floppy disks are the main storage medium for data used with various devices, including computers. Different devices have different systems of saving data, therefore it is necessary to first configure the floppy disk to the system of the device being used. This operation is called “formatting.”

- There are two types of floppy disks: MF2DD (double sided, double density) and MF2HD (double sided, high density), and each type has different formatting systems.
- CLP-170 can record and playback with both types of floppy disks.
- When formatted by the CLP-170, a 2DD disk saves up to 720 KB (kilobytes) and a 2HD disk saves up to 1.44 MB (megabytes). (The figures “720 KB” and “1.44 MB” indicate the data memory capacity. They are also used to indicate the format type of disk.)
- Playback is only possible when the MIDI device to be used is compatible with the format of the disk.

---

## Sequence Format

---

The system which records song data is called “sequence format.”

- Playback is only possible when the sequence format of the disk matches that of the MIDI device.

[Common Sequence Formats]

### ■ SMF (Standard MIDI File)

This is the most common sequence format.

- Standard MIDI Files are generally available as one of two types: Format 0 or Format 1.
- Many MIDI devices are compatible with Format 0, and most commercially available software is recorded as Format 0.
- The CLP-170/150 is compatible with both Format 0 and Format 1.
- Performance data recorded on the CLP-170/150 is saved in the SMF format 0 in a floppy disk.

### ■ ESEQ

This sequence format is compatible with many of Yamaha’s MIDI devices, including the Clavinova series instruments. This is a common format used with various Yamaha software.

- The CLP-170/150 is compatible with ESEQ.

---

### Voice Allocation Format

---

With MIDI, voices are assigned to specific numbers, called “program numbers.” The numbering standard (order of voice allocation) is referred to as the “voice allocation format.”

- Voices may not play back as expected unless the voice allocation format of the song data matches that of the compatible MIDI device used for playback.

[Main Voice Allocation Formats]

#### ■ GM System Level 1

This is one of the most common voice allocation formats.

- Many MIDI devices are compatible with GM System Level 1, as is most commercially available software.
- The CLP-170/150 is compatible with GM System Level 1.

#### ■ XG

XG is a major enhancement of the GM System Level 1 format, and was developed by Yamaha specifically to provide more voices and variations, as well as greater expressive control over voices and effects, and to ensure compatibility of data well into the future.

- The CLP-170/150 is compatible with XG.
- Performance data recorded with preset voices on the CLP-170/150 can be played on other XG-compatible instruments.

#### ■ DOC (Disk Orchestra Collection)

This voice allocation format is compatible with many of Yamaha’s MIDI devices, including the Clavinova series instruments.

This is also common format used with various Yamaha software.

The CLP-170 is compatible with DOC.

- Even if the devices and data used satisfy all the conditions above, the data may still not be completely compatible, depending on the specifications of the devices and particular data recording methods.

# Preset Voice List

○: YES, ×: No

Voice group	Voice name	Stereo sampling	Touch Sense	Dynamic sampling	Key-off samples	String resonance	Voice description
GRAND PIANO1	GrandPiano1	○	○	○	○	○	This sound was sampled from a full concert grand piano. Three stages of dynamics were sampled, and no effort has been spared in making the sound virtually identical to that of an acoustic piano. Even the tonal changes produced by the damper pedal and the subtle sounds of releasing a key are reproduced. The sympathetic vibration (string resonance) that occurs between the strings of an acoustic piano has also been simulated. Suitable not only for classical compositions but also for piano pieces of any style.
	MellowPiano	○	○	○	○	○	A warm and mellow piano sound. Ideal for classical music.
	RockPiano	○	○	○	○	○	A bright-sounding piano. Ideal for rock styles.
	HonkyTonk Piano	○	○	○	○	×	A honky-tonk style piano. Enjoy a tonal character that is quite different than a grand piano.
GRAND PIANO2	GrandPiano2	○	○	×	×	×	A spacious and clear piano sound with a bright resonance. Ideal for popular music.
	BrightPiano	○	○	×	×	×	A spacious and bright piano sound. Ideal for popular and rock music.
E.PIANO1	E.Piano1	×	○	○	×	×	An electronic piano sound produced by an FM synthesizer. The tone will change as you vary your playing touch. Ideal for popular music.
	SynthPiano	×	○	×	×	×	This voice simulates the electric piano sound produced by synthesizers in popular music. It also goes well with the acoustic piano sound.
E.PIANO2	E.Piano2	×	○	○	○	×	The sound of an electric piano using hammer-struck metallic "tines." Soft tone when played lightly, and an aggressive tone when played hard.
	Vintage E.Piano	×	○	○	×	×	A different type of electric piano sound. Widely used in rock and popular music.
HARPSICHORD	Harpsichord 8'	○	×	×	○	×	The sound of the instrument frequently used in baroque music. Variations in playing touch will not affect the volume, and a characteristic sound will be heard when you release the key.
	Harpsichord 8'+4'	○	×	×	○	×	A harpsichord with an added upper octave. Produces a more brilliant sound.
E.CLAVICHORD	E.Clavichord	×	○	×	○	×	This is the voice of a keyboard that produces sound by striking the strings with magnetic pickups. This funky sound is popular in black contemporary music. Because of its unique structure, the instrument produces a peculiar sound when you release the keys.
	Wah Clavi.	×	○	×	○	×	A distinctive effect is preset.
VIBRA-PHONE	Vibraphone	○	○	○	×	×	Vibraphone played with relatively soft mallets. The tone becomes more metallic the harder you play.
	Marimba	○	○	×	×	×	A marimba sound, sampled in stereo for spaciousness and realism.
	Celesta	○	○	○	×	×	The sound of a celesta (a percussion instrument in which hammers strike metallic bars to produce sound). This instrument is well-known for its appearance in "Dance of the Sugar-plum Fairies" from Tchaikovsky's "Nutcracker Suite."

## Preset Voice List

Voice group	Voice name	Stereo sampling	Touch Sense	Dynamic sampling	Key-off samples	String resonance	Voice description
GUITAR	NylonGuitar	(○)	○	(○)	×	×	A warm and natural nylon-string guitar sound. Enjoy the atmosphere it adds to a quiet song. (On the CLP-170, stereo sampling is used for realism. Strongly-played notes will sound a harmonic, producing an even more guitar-like impression.)
	SteelGuitar	×	○	×	×	×	A bright steel guitar sound. Ideal for popular music.
CHURCH ORGAN	PipeOrgan Principal	○	×	×	×	×	This voice features the combination of pipes (8'+4'+2') of a principal (brass instrument) organ. It is suitable for Baroque church music.
	PipeOrgan Tutti	○	×	×	×	×	This voice features a full coupler of a pipe organ, famous for the sound used in Toccatta and Fugue by Bach.
	PipeOrgan Flute1	○	×	×	×	×	A pipe organ sound that combines flute-type (woodwind type) stops of different pitches (8' + 4'). This is a gentle sound that is ideal for accompanying hymns.
	PipeOrgan Flute2	○	×	×	×	×	A pipe organ sound that combines flute-type (woodwind type) stops of different pitches (8' + 4' + 1-1/3'). This is brighter than PipeOrganFlute1, and is suitable for solos.
JAZZORGAN	JazzOrgan	×	×	×	×	×	The sound of a "tonewheel" type electric organ. Often heard in jazz and rock idioms.
	RotaryOrgan	×	×	×	×	×	A bright electric organ sound.
	MellowOrgan	×	×	×	×	×	A mellow electric organ sound. Ideal for calmer songs.
STRINGS	Strings	○	○	×	×	×	Stereo-sampled, large-scale strings ensemble with realistic reverb. Try combining this voice with piano in the Dual mode.
	SynthStrings	×	○	×	×	×	A bright and spacious strings sound. Suitable for sustained parts in the background of an ensemble.
	SlowStrings	○	○	×	×	×	The sound of a string ensemble, with a slow attack. Suitable for use in Dual mode with GRAND PIANO or E.PIANO.
CHOIR	Choir	×	○	×	×	×	A big, spacious choir voice. Perfect for creating rich harmonies in slow pieces.
	SlowChoir	×	○	×	×	×	The sound of a choir with a slow attack. Suitable for use in Dual mode with GRAND PIANO or E.PIANO.
	Scat	×	○	○	×	×	You can enjoy jazz "scatting" with this voice. Depending on how hard and what note range you play, different sounds will be produced.
SYNTH.PAD	SynthPad1	×	○	×	×	×	A warm, mellow, and spacious synth sound. Ideal for sustained parts in the background of an ensemble.
	SynthPad2	×	○	×	×	×	A clear and spacious synth sound. Ideal for sustained parts in the background of an ensemble.
WOOD BASS	WoodBass	×	○	×	×	×	The sound of a finger-plucked upright bass. Frequently used in jazz and Latin music.
	Bass&Cymbal	×	○	×	×	×	The sound of a cymbal has been layered onto the bass. Effective when used for jazz walking-bass lines.
E.BASS	ElectricBass	×	○	×	×	×	The sound of an electric bass. Frequently used in jazz, rock, and popular music.
	FretlessBass	×	○	×	×	×	The sound of a fretless bass. Suitable for styles such as jazz and fusion.

\* (○) are provided only on the CLP-170.

# Voice Combination Examples (Dual and Split)

## Dual

MAIN + MAIN	GrandPiano1 + E.Piano1 GrandPiano1 + E.Piano2	This combination is often used in popular music.
MAIN + MAIN	GrandPiano1 + SynthPiano	This produces a fantasy, spacious piano sound.
MAIN + MAIN	GrandPiano2 + GrandPiano2	This combination sounds as if you are playing two notes that are one octave apart. It is suitable for the accompaniment of Salsa music.
MAIN + MAIN	E.Piano1 + SlowChoir	This is suitable for romantic ballads.
MAIN + MAIN	E.Piano2 + E.Clavichord	This is suitable for funk, rhythm & blues, and soul music.
MAIN + MAIN	Harpsichord8' + Strings	This combination is very suitable for Baroque music.
MAIN + MAIN	Celesta + SynthStrings	This combination adds strings and bell sound. A delay effect is automatically applied.

## Split

MAIN / LEFT	GrandPiano1 / WoodBass or Bass&Cymbal	This is recommended for light Jazz music. The damper pedal is effective on the voice assigned to the right-hand range.
MAIN / LEFT	Celesta / Choir	This is suitable for a peaceful, somewhat cute song.
MAIN / LEFT	Choir / GrandPiano1	Play these voices elegantly along with piano arpeggio. Playing the Choir voice in chords would be more effective.
MAIN / LEFT	Scat / WoodBass	This combination features a cool (stylish) jazz chorus. The Scat voice is touch sensitive, adding a variety of expressions.
MAIN / LEFT	E.Piano2 / Scat	Playing the Scat voice for a bass part may create an interesting sound.

## Dual + Split

MAIN + MAIN / LEFT	GrandPiano1 + SynthString / GrandPiano1	This combination creates the thick sound of a layered piano and strings.
MAIN + MAIN / LEFT	GrandPiano2 + E.Piano1 / ElectricBass	This sound is suitable for fusion. Deeper reverb and chorus (page 79) will improve the groove. The damper pedal is effective on the voice assigned to the right-hand range.
MAIN + MAIN / LEFT + LEFT	Harpsichord8' + 4' + Strings / Harpsichord8' + Strings	This combination makes a very brilliant sound.

# CLP-150: Keyboard Stand Assembly

## ⚠ CAUTION

- Be careful not to confuse parts, and be sure to install all parts in the correct direction. Please assemble in accordance with the sequence given below.
- Assembly should be carried out by at least two persons.
- Be sure to use the correct screw size, as indicated below. Use of incorrect screws can cause damage.
- Be sure to tighten up all screws upon completing assembly of each unit.
- To disassemble, reverse the assembly sequence given below.

Have a Phillips-head (+) screwdriver ready.

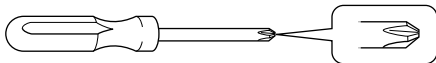

Remove the following parts from the package.

### Assembly Parts

6 × 25 mm long screws ×4 ❶



4 × 20 mm tapping screws ×4 ❷



6 × 16 mm short screws ×6 ❸



Cord holders ×2



4 × 12 mm thin screws ×2 ❹

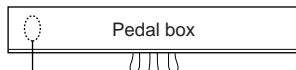
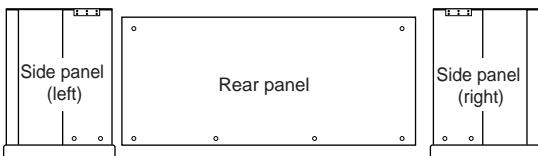
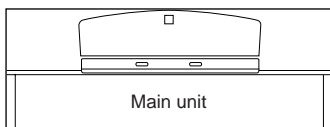

Bundled pedal cord inside

AC power cord



## 1. Attach the side panels to the pedal box.

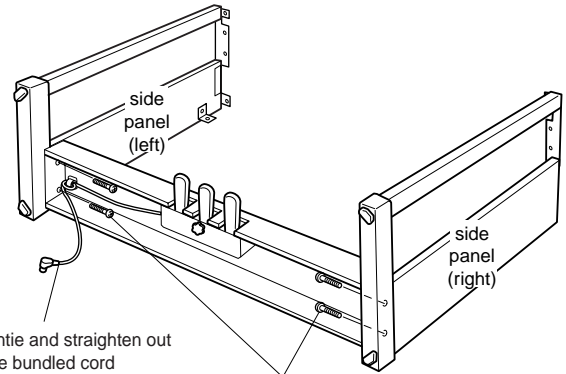

(1) Untie and straighten out the bundled cord attached to the bottom of the pedal box.

(2) Use the four 6×25 mm long screws ❶ to attach the pedal box. First attach one side panel, then attach the other side panel.

## 2. Attach the rear panel.

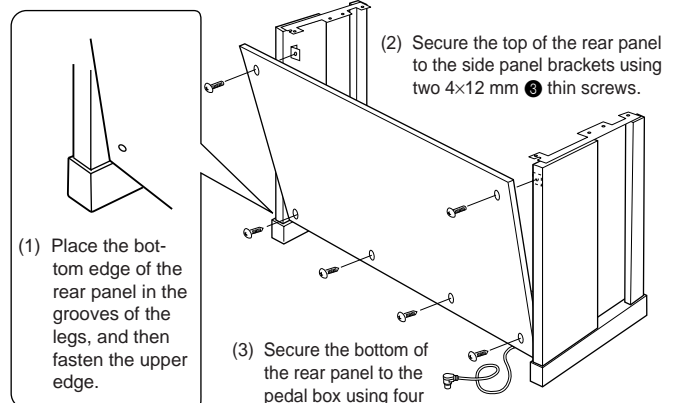

(1) Place the bottom edge of the rear panel in the grooves of the legs, and then fasten the upper edge.

(2) Secure the top of the rear panel to the side panel brackets using two 4×12 mm ❹ thin screws.

(3) Secure the bottom of the rear panel to the pedal box using four 4×20 mm ❷ tapping screws.



### 3. Fix the main unit.

**⚠ CAUTION**

Fingers can become pinched between the main unit and the rear or side panels, be extra careful so as not to drop the main unit.

**⚠ CAUTION**

Do not hold the keyboard in any position other than the position shown in the illustration.

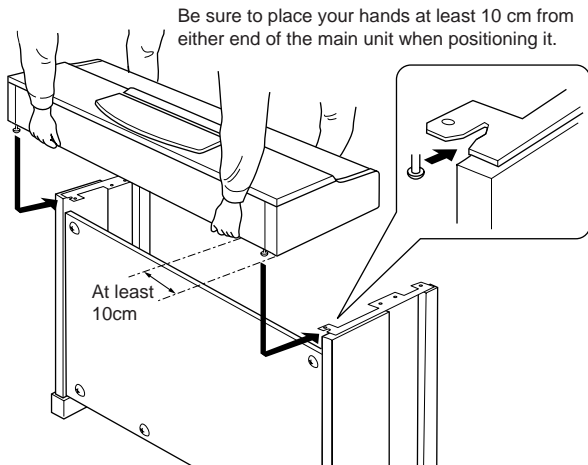

### 4. Connect the pedal cord.

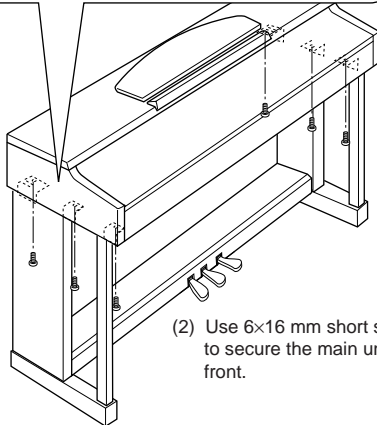
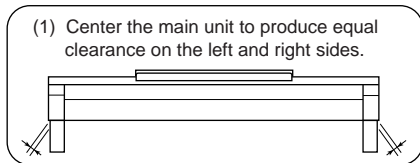

### 5. Secure the pedal cord.

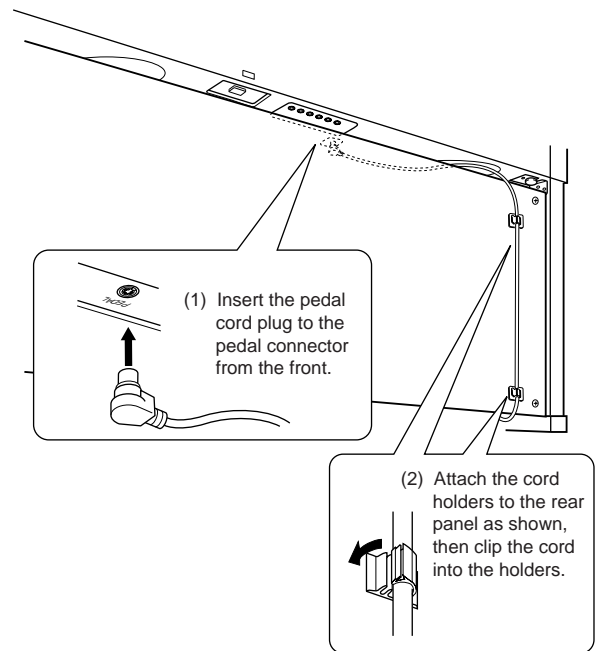

### 6. Set the voltage selector and connect the power cord.

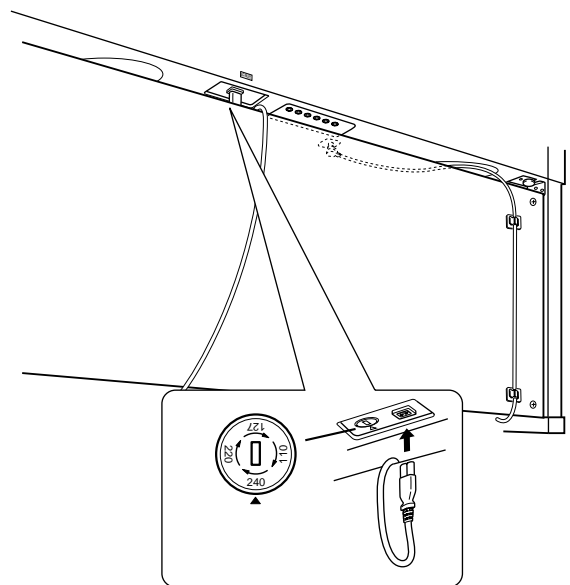

#### Voltage Selector

Before connecting the AC power cord, check the setting of the voltage selector which is provided in some areas. To set the selector for 110V, 127V, 220V or 240V main voltages, use a "minus" screwdriver to rotate the selector dial so that the correct voltage for your region appears next to the pointer on the panel. The voltage selector is set at 240V when the unit is initially shipped.

After the proper voltage has been selected, connect the AC power cord to the AC INLET and an AC wall outlet. A plug adaptor may be also provided in some areas to match the pin configuration of the AC wall outlets in your area.

**⚠ WARNING**

An improper voltage setting can cause serious damage to the Clavinova or result in improper operation.

## 7. Set the adjuster.

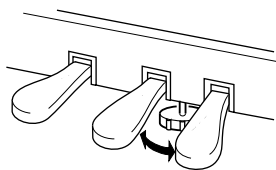

Rotate the adjuster until it comes in firm contact with the floor surface.

After completing the assembly, please check the following.

- **Are there any parts left over?**
  - Review the assembly procedure and correct any errors.
- **Is the Clavinova clear of doors and other movable fixtures?**
  - Move the Clavinova to an appropriate location.
- **Does the Clavinova make a rattling noise when you shake it?**
  - Tighten all screws.
- **Does the pedal box rattle or give way when you step on the pedals?**
  - Turn the adjuster so that it is set firmly against the floor.
- **Are the pedal and power cords inserted securely into the sockets?**
  - Check the connection.
- **If the main unit creaks or is otherwise unsteady when you play on the keyboard, refer to the assembly diagrams and retighten all screws.**

*When moving the instrument after assembly, always hold the bottom of the main unit.*

### ⚠ CAUTION

Do not hold the keyboard cover or top portion. Improper handling can result in damage to the instrument or personal injury.

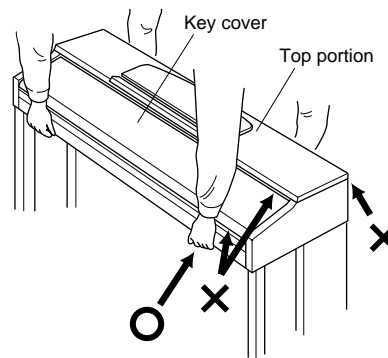

# CLP-170: Keyboard Stand Assembly

## ⚠ CAUTION

- Be careful not to confuse parts, and be sure to install all parts in the correct direction. Please assemble in accordance with the sequence given below.
- Assembly should be carried out by at least two persons.
- Be sure to use the correct screw size, as indicated below. Use of incorrect screws can cause damage.
- Be sure to tighten up all screws upon completing assembly of each unit.
- To disassemble, reverse the assembly sequence given below.

## TIP

The CLP-170 has an iAFC (Instrumental Active Field Control) effect. This uses the speaker on the rear of the instrument to create a sense of reverberation and spaciousness. In order to take full advantage of iAFC, we recommend that you do the following.

- Position the Clavinova so that its rear panel is at least 10 cm away from the wall.
- Perform the automatic adjustment after you turn on the power of the Clavinova for the first time, and after each time you move the Clavinova to a different location (page 86).

Have a Phillips-head (+) screwdriver ready.

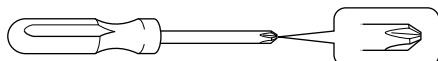

Remove the following parts from the package.

### Assembly Parts

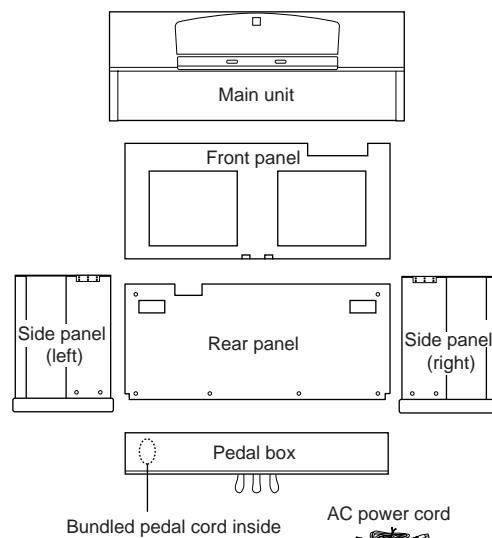
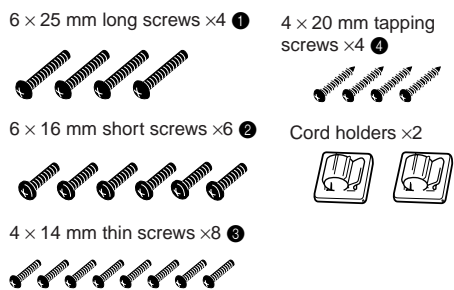

## 1. Attach the side panels to the pedal box.

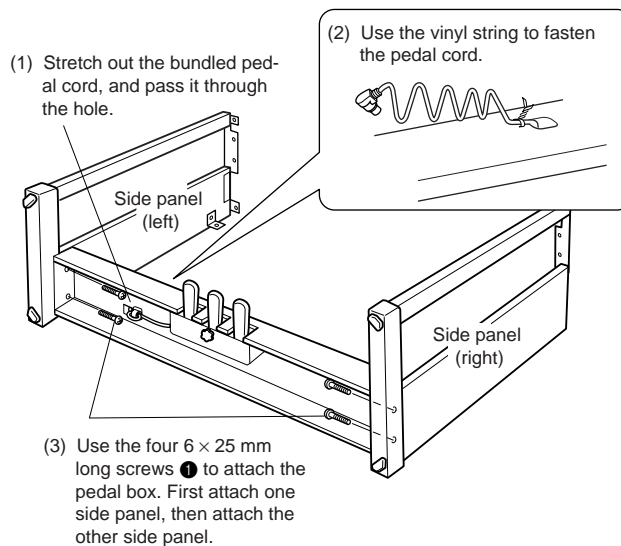

## CLP-170: Keyboard Stand Assembly

### 2. Attach the front panel.

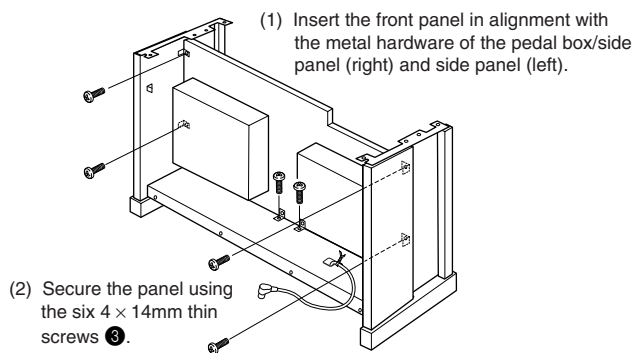

- \* Make sure that there is no gap between the front panel and the side panel (right) and side panel (left)
- \* Insert six screws into the smaller holes on the brackets.

### 3. Mount the main unit.

#### ⚠ CAUTION

Fingers can become pinched between the main unit and the rear or side panels, be extra careful so as not to drop the main unit.

#### ⚠ CAUTION

Do not hold the keyboard in any position other than the position shown in the illustration.

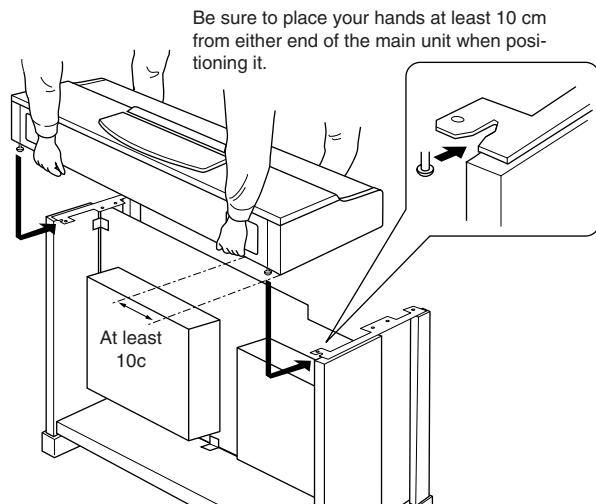

### 4. Fix the main unit.

- (1) Center the main unit to produce equal clearance on the left and right sides.

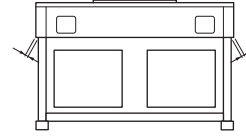

- (3) Use 6 × 16 mm short screws ② to fasten the main unit from the front.

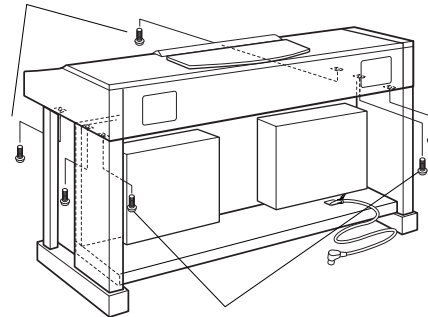

- (2) Use 6 × 16 mm short screws ② to secure the main unit from the rear.

### 5. Connect the speaker cord and iAFC mic cords.

- (1) Unbundle the speaker cord.

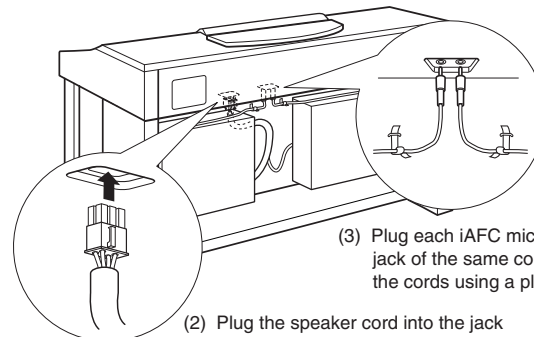

- (2) Plug the speaker cord into the jack so that the tab extends toward the right when viewed from the rear.
- (3) Plug each iAFC mic cord into a jack of the same color, and affix the cords using a plastic band.

### 6. Connect the pedal cord.

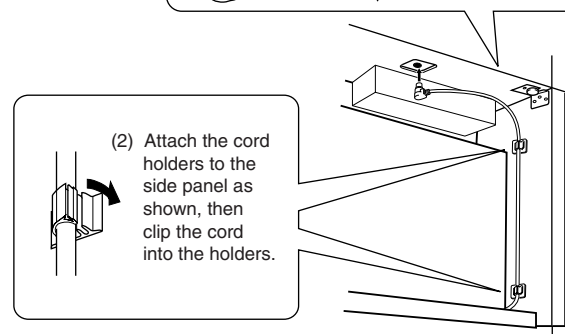
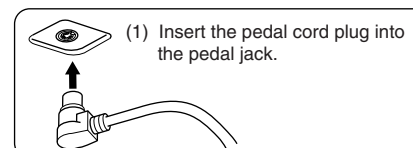

## 7. Fasten the rear panel.

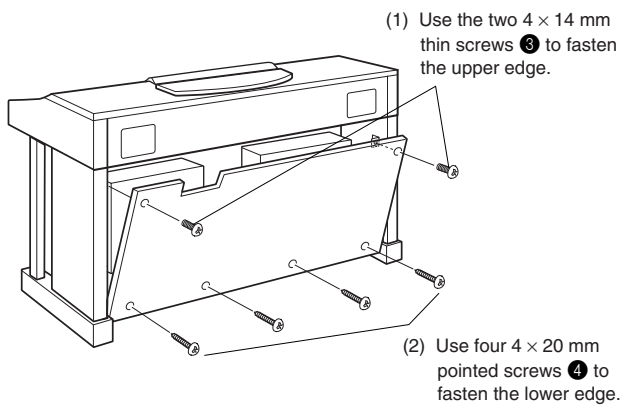

## 8. Set the adjuster.

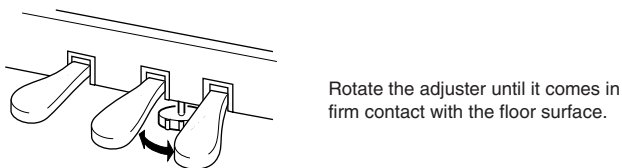

## 9. Set the voltage selector and connect the power cord.

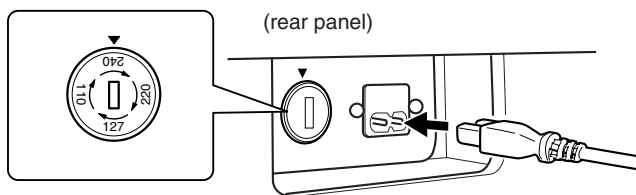

### Voltage Selector

Before connecting the AC power cord, check the setting of the voltage selector which is provided in some areas. To set the selector for 110V, 127V, 220V or 240V main voltages, use a "minus" screwdriver to rotate the selector dial so that the correct voltage for your region appears next to the pointer on the panel. The voltage selector is set at 240V when the unit is initially shipped. After the proper voltage has been selected, connect the AC power cord to the AC INLET and an AC wall outlet. A plug adaptor may be also provided in some areas to match the pin configuration of the AC wall outlets in your area.

### ⚠ WARNING

An improper voltage setting can cause serious damage to the Clavinova or result in improper operation.

After completing the assembly, please check the following.

- **Are there any parts left over?**
  - Review the assembly procedure and correct any errors.
- **Is the Clavinova clear of doors and other movable fixtures?**
  - Move the Clavinova to an appropriate location.
- **Does the Clavinova make a rattling noise when you shake it?**
  - Tighten all screws.
- **Does the pedal box rattle or give way when you step on the pedals?**
  - Turn the adjuster so that it is set firmly against the floor.
- **Are the pedal and power cords inserted securely into the sockets?**
  - Check the connection.
- **If the main unit creaks or is otherwise unsteady when you play on the keyboard, refer to the assembly diagrams and retighten all screws.**

*When moving the instrument after assembly, always hold the bottom of the main unit.*

### ⚠ CAUTION

Do not hold the keyboard cover or top portion. Improper handling can result in damage to the instrument or personal injury.

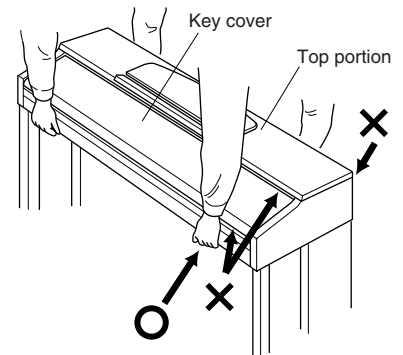

# Index

You can search the desired section using not only the terminology in this manual but also commonly-used words. The \* mark indicates that the corresponding page includes the terminology explanation in the right column.

## Numerics

---

- 50 greats for the Piano 13
- 50 Piano Preset Songs 24
  - Practicing a one-hand part 26

## A

---

- Adding variation to the sound
  - Effect function 30
- Assembly (CLP-150) 112
- Assembly (CLP-170) 115
- Assigning the START/STOP function to a pedal 94
- AUX IN jacks 60
- AUX OUT jacks 60
- AUX PEDAL jacks 59
- Auxiliary pedal function 84

## B

---

- BackUp 95
- Bench 13
- BRILLIANCE 30

## C

---

- Center pedal 29
- Center pedal function 83
- Character Code 54
- Characters 54
- CHORUS 31
- combining two voices
  - Dual mode 33
- Connection
  - Audio 60
  - computer 61
  - MIDI 64
  - Other Components 59
  - Serial 62
  - Speaker 60
  - USB 65
- Connectors
  - MIDI IN/OUT/THRU 59, 64
- CONTRAST\* 18

## D

---

- Damper (right) pedal 29
- Data Compatibility 107
- Data type 57
- Default (Normal) setting\* 30
- Demonstration tunes 22
- Detailed Settings 68
  - iAFC 85
  - Metronome 76
  - MIDI 87
  - Other settings 91
  - recording and playback 73
  - voices 77
- Disk
  - Copy 52
  - Format 53
  - SongAutoOpen 54
- Disk song 46
- Display contrast 18
- DOWN (TEMPO)
  - 50 Piano Preset Songs 25
  - metronome 37
- Dual
  - Detailed settings 77
  - Recording 45
- Dual mode
  - combining two voices 33

## E

---

- Effect function 30
- equalizer 82
- EXIT 21
- EXTRA TRACKS
  - the third or more tracks 43

## F

---

- FactorySet 95
- Fast forward 25, 56
- FILE\* 46
- Floppy Disk 12
- Formatting a floppy disk 53

## H

---

- Headphones 18
- HOST SELECT switch 59

## I

---

- iAFC 32
- iAFC
  - iAFC Detailed settings 85

## J

---

- Jacks
  - AUX IN 60
  - AUX OUT 60
  - AUX PEDAL 59
  - PHONES 18
  - TO HOST 59, 62
  - USB 59

## L

---

- LCD → Screen 21
  - Contrast 18
- Left pedal 29
- Left pedal function 84
- List
  - Demonstration tunes 22
  - Detailed Settings 68
  - Message 96
  - Preset Voice 109

## M

---

- Maintenance 13
- MASTER VOLUME\* 18
- Memory 46
- Memory song 46
- MemoryBackUp 95
- Message List 96
- Metronome 37
  - Detailed settings 76
- METRONOME SETTING 76
- MIDI 87
  - Detailed settings 87
- MIDI cables 64
- MIDI connectors 61, 64
- MIDI driver 62
- MIDI SETTING 87
- Music braces 16
- Music Data 55
- Music rest 16

## N

---

New Song 38  
Normal setting\* 30

## O

---

Other settings 91

## P

---

Pedal Function  
  Auxiliary 84  
  Center 83  
  Left 84  
  Right 83  
Pedals 29  
Personal computer 61  
PHONES jacks 18  
Playback  
  50 Piano Preset Songs 24  
  Demo Songs 23  
  Recorded Songs and Music Data 56  
Playing back repeatedly (song) 75  
Playing back repeatedly  
  (specifying the range) 74  
playing two voices → Split mode 35  
POWER 17  
Practicing a one-hand part  
  (50 preset songs) 26  
Preset song memory 46  
Preset Voice List 109

## R

---

Recording  
  Tape Recorder 60  
Recording in Dual 45  
Recording in Split 45  
Recording Your Performance 38  
Re-recording 40  
REVERB 31  
Rewind 25, 56  
Right pedal 29  
Right pedal function 83

## S

---

Scale 92  
Screen 21  
Select  
  50 piano preset songs 24  
  Demo Songs 23  
  Recorded Songs and Music Data 55  
Selecting a touch response 91  
SETTING  
  metronome 76  
  Volume 18  
SMF (Standard MIDI File) 107  
Soft (left) pedal 29  
Song  
  Data Type 57  
  Delete 50  
  Detailed settings 73  
  Playing back repeatedly 75  
  Rename 51  
  Store 46  
  Store (Floppy disk) 49  
  Store (Storage memory) 49  
SONG [START/STOP]  
  50 Piano Preset Songs 24  
  Recorded Songs and Music Data 56  
  Recording 39  
SONG BALANCE 45  
SONG SELECT  
  50 Piano Preset Songs 24  
  Recorded Songs and Music Data 55  
  Recording 38  
SONG SETTING 73  
Sostenuto (center) pedal 29  
Sound  
  brilliance 30  
  expression 30  
  reverberation 31  
  spread and spaciousness 31  
Soundboard reverb 31  
Split  
  Detailed settings 77  
  Recording 45  
Split mode → playing two voices 35  
Split point 36  
Splitting the keyboard range and playing  
  two different voices 35  
START/STOP  
  metronome 37

Storage memory 46  
StringResonance 93  
SustainSampling 93  
Synchro Start  
  50 preset songs 26  
  Recorded Songs and Music Data 56

## T

---

TEMPO  
  50 Piano Preset Songs 25  
  metronome 37  
  Recorded Songs and Music Data 56  
the third or more tracks → EXTRA  
  TRACKS 43  
TO HOST jack 59, 62  
TOP  
  50 Piano Preset Songs 25  
  Recorded Songs and Music Data 56  
  Recording 39  
TouchResponse 91  
Track playback on and off 57  
TRACK1/TRACK2  
  50 Piano Preset Songs 26  
  Recording 38, 42  
Troubleshooting 106  
Tune 91  
Type of characters 54  
Type of data (recorded) 102

## U

---

UP (TEMPO)  
  50 Piano Preset Songs 25  
  metronome 37  
USB jack 59

## V

---

Voice group buttons 28, 35  
VOICE SETTING 77  
Voices\* 28  
  Detailed settings 77  
Volume  
  Balance (SONG BLANCE) 45  
  Setting 18

## X

---

XG 108

**MEMO**



# IMPORTANT SAFETY INSTRUCTIONS

## INFORMATION RELATING TO PERSONAL INJURY, ELECTRICAL SHOCK, AND FIRE HAZARD POSSIBILITIES HAS BEEN INCLUDED IN THIS LIST.

**WARNING-** When using any electrical or electronic product, basic precautions should always be followed. These precautions include, but are not limited to, the following:

- 1.** Read all Safety Instructions, Installation Instructions, Special Message Section items, and any Assembly Instructions found in this manual **BEFORE** making any connections, including connection to the main supply.
- 2.** Main Power Supply Verification: Yamaha products are manufactured specifically for the supply voltage in the area where they are to be sold. If you should move, or if any doubt exists about the supply voltage in your area, please contact your dealer for supply voltage verification and (if applicable) instructions. The required supply voltage is printed on the name plate. For name plate location, please refer to the graphic found in the Special Message Section of this manual.
- 3.** This product may be equipped with a polarized plug (one blade wider than the other). If you are unable to insert the plug into the outlet, turn the plug over and try again. If the problem persists, contact an electrician to have the obsolete outlet replaced. Do **NOT** defeat the safety purpose of the plug.
- 4.** Some electronic products utilize external power supplies or adapters. Do **NOT** connect this type of product to any power supply or adapter other than one described in the owners manual, on the name plate, or specifically recommended by Yamaha.
- 5.** **WARNING:** Do not place this product or any other objects on the power cord or place it in a position where anyone could walk on, trip over, or roll anything over power or connecting cords of any kind. The use of an extension cord is not recommended! If you must use an extension cord, the minimum wire size for a 25' cord (or less) is 18 AWG. **NOTE:** The smaller the AWG number, the larger the current handling capacity. For longer extension cords, consult a local electrician.
- 6.** Ventilation: Electronic products, unless specifically designed for enclosed installations, should be placed in locations that do not interfere with proper ventilation. If instructions for enclosed installations are not provided, it must be assumed that unobstructed ventilation is required.
- 7.** Temperature considerations: Electronic products should be installed in locations that do not significantly contribute to their operating temperature. Placement of this product close to heat sources such as; radiators, heat registers and other devices that produce heat should be avoided.
- 8.** This product was **NOT** designed for use in wet/damp locations and should not be used near water or exposed to rain. Examples of wet/damp locations are; near a swimming pool, spa, tub, sink, or wet basement.
- 9.** This product should be used only with the components supplied or; a cart, rack, or stand that is recommended by the manufacturer. If a cart, rack, or stand is used, please observe all safety markings and instructions that accompany the accessory product.
- 10.** The power supply cord (plug) should be disconnected from the outlet when electronic products are to be left unused for extended periods of time. Cords should also be disconnected when there is a high probability of lightning and/or electrical storm activity.
- 11.** Care should be taken that objects do not fall and liquids are not spilled into the enclosure through any openings that may exist.
- 12.** Electrical/electronic products should be serviced by a qualified service person when:
  - a. The power supply cord has been damaged; or
  - b. Objects have fallen, been inserted, or liquids have been spilled into the enclosure through openings; or
  - c. The product has been exposed to rain; or
  - d. The product does not operate, exhibits a marked change in performance; or
  - e. The product has been dropped, or the enclosure of the product has been damaged.
- 13.** Do not attempt to service this product beyond that described in the user-maintenance instructions. All other servicing should be referred to qualified service personnel.
- 14.** This product, either alone or in combination with an amplifier and headphones or speaker/s, may be capable of producing sound levels that could cause permanent hearing loss. **DO NOT** operate for a long period of time at a high volume level or at a level that is uncomfortable. If you experience any hearing loss or ringing in the ears, you should consult an audiologist. **IMPORTANT:** The louder the sound, the shorter the time period before damage occurs.
- 15.** Some Yamaha products may have benches and/or accessory mounting fixtures that are either supplied as a part of the product or as optional accessories. Some of these items are designed to be dealer assembled or installed. Please make sure that benches are stable and any optional fixtures (where applicable) are well secured **BEFORE** using. Benches supplied by Yamaha are designed for seating only. No other uses are recommended.

## PLEASE KEEP THIS MANUAL

## FCC INFORMATION (U.S.A.)

### 1. **IMPORTANT NOTICE: DO NOT MODIFY THIS UNIT!**

This product, when installed as indicated in the instructions contained in this manual, meets FCC requirements. Modifications not expressly approved by Yamaha may void your authority, granted by the FCC, to use the product.

2. **IMPORTANT:** When connecting this product to accessories and/or another product use only high quality shielded cables. Cable/s supplied with this product **MUST** be used. Follow all installation instructions. Failure to follow instructions could void your FCC authorization to use this product in the USA.
3. **NOTE:** This product has been tested and found to comply with the requirements listed in FCC Regulations, Part 15 for Class "B" digital devices. Compliance with these requirements provides a reasonable level of assurance that your use of this product in a residential environment will not result in harmful interference with other electronic devices. This equipment generates/uses radio frequencies and, if not installed and used according to the instructions found in the users manual, may cause interference harmful to the operation of

other electronic devices. Compliance with FCC regulations does not guarantee that interference will not occur in all installations. If this product is found to be the source of interference, which can be determined by turning the unit "OFF" and "ON", please try to eliminate the problem by using one of the following measures:

Relocate either this product or the device that is being affected by the interference.

Utilize power outlets that are on different branch (circuit breaker or fuse) circuits or install AC line filter/s.

In the case of radio or TV interference, relocate/reorient the antenna. If the antenna lead-in is 300 ohm ribbon lead, change the lead-in to co-axial type cable.

If these corrective measures do not produce satisfactory results, please contact the local retailer authorized to distribute this type of product. If you can not locate the appropriate retailer, please contact Yamaha Corporation of America, Electronic Service Division, 6600 Orangethorpe Ave, Buena Park, CA90620

The above statements apply **ONLY** to those products distributed by Yamaha Corporation of America or its subsidiaries.

\* This applies only to products distributed by YAMAHA CORPORATION OF AMERICA.

(class B)

### IMPORTANT NOTICE FOR THE UNITED KINGDOM

#### Connecting the Plug and Cord

**IMPORTANT.** The wires in this mains lead are coloured in accordance with the following code:

BLUE : NEUTRAL  
BROWN : LIVE

As the colours of the wires in the mains lead of this apparatus may not correspond with the coloured markings identifying the terminals in your plug proceed as follows:

The wire which is coloured BLUE must be connected to the terminal which is marked with the letter N or coloured BLACK.

The wire which is coloured BROWN must be connected to the terminal which is marked with the letter L or coloured RED.

Making sure that neither core is connected to the earth terminal of the three pin plug.

(2 wires)

- This applies only to products distributed by Yamaha-Kemble Music (U.K.) Ltd.

**CAUTION:** TO PREVENT ELECTRIC SHOCK, MATCH WIDE BLADE OF PLUG TO WIDE SLOT, FULLY INSERT.

**ATTENTION:** POUR ÉVITER LES CHOCS ÉLECTRIQUES, INTRODUIRE LA LAME LA PLUS LARGE DE LA FICHE DANS LA BORNE CORRESPONDANTE DE LA PRISE ET POUSSER JUSQU'AU FOND.

(polarity)

- This applies only to products distributed by Yamaha Canada Music Ltd.
- Ceci ne s'applique qu'aux produits distribués par Yamaha Canada Musique Ltée.

For details of products, please contact your nearest Yamaha or the authorized distributor listed below.

Pour plus de détails sur les produits, veuillez-vous adresser à Yamaha ou au distributeur le plus proche de vous figurant dans la liste suivante.

Die Einzelheiten zu Produkten sind bei Ihrer unten aufgeführten Niederlassung und bei Yamaha Vertragshändlern in den jeweiligen Bestimmungsländern erhältlich.

Para detalles sobre productos, contacte su tienda Yamaha más cercana o el distribuidor autorizado que se lista debajo.

## NORTH AMERICA

### CANADA

**Yamaha Canada Music Ltd.**  
135 Milner Avenue, Scarborough, Ontario,  
M1S 3R1, Canada  
Tel: 416-298-1311

### U.S.A.

**Yamaha Corporation of America**  
6600 Orangethorpe Ave., Buena Park, Calif. 90620,  
U.S.A.  
Tel: 714-522-9011

## CENTRAL & SOUTH AMERICA

### MEXICO

**Yamaha de Mexico S.A. De C.V.,  
Departamento de ventas**  
Javier Rojo Gomez No.1149, Col. Gpe Del  
Moral, Deleg. Iztapalapa, 09300 Mexico, D.F.  
Tel: 686-00-33

### BRAZIL

**Yamaha Musical do Brasil LTDA.**  
Av. Rebouças 2636, São Paulo, Brasil  
Tel: 011-853-1377

### ARGENTINA

**Yamaha de Panamá S.A. Sucursal de Argentina**  
Viamonte 1145 Piso 2-B 1053,  
Buenos Aires, Argentina  
Tel: 1-4371-7021

### PANAMA AND OTHER LATIN AMERICAN COUNTRIES/ CARIBBEAN COUNTRIES

**Yamaha de Panamá S.A.**  
Torre Banco General, Piso 7, Urbanización Marbella,  
Calle 47 y Aquilino de la Guardia,  
Ciudad de Panamá, Panamá  
Tel: +507-269-5311

## EUROPE

### THE UNITED KINGDOM

**Yamaha-Kemble Music (U.K.) Ltd.**  
Sherbourne Drive, Tilbrook, Milton Keynes,  
MK7 8BL, England  
Tel: 01908-366700

### IRELAND

**Danfay Ltd.**  
61D, Sallynoggin Road, Dun Laoghaire, Co. Dublin  
Tel: 01-2859177

### GERMANY

**Yamaha Music Central Europe GmbH**  
Siemensstraße 22-34, 25462 Rellingen, Germany  
Tel: 04101-3030

### SWITZERLAND/LIECHTENSTEIN

**Yamaha Music Central Europe GmbH,  
Branch Switzerland**  
Seefeldstrasse 94, 8008 Zürich, Switzerland  
Tel: 01-383 3990

### AUSTRIA

**Yamaha Music Central Europe GmbH,  
Branch Austria**  
Schleiergasse 20, A-1100 Wien, Austria  
Tel: 01-60203900

### THE NETHERLANDS

**Yamaha Music Central Europe GmbH,  
Branch Nederland**  
Clarissenhof 5-b, 4133 AB Vianen, The Netherlands  
Tel: 0347-358 040

### BELGIUM/LUXEMBOURG

**Yamaha Music Central Europe GmbH,  
Branch Belgium**  
Rue de Geneve (Genevstraat) 10, 1140 - Brussels,  
Belgium  
Tel: 02-726 6032

### FRANCE

**Yamaha Musique France, S.A.  
Division Professionnelle**  
BP 70-77312 Marne-la-Vallée Cedex 2, France  
Tel: 01-64-61-4000

### ITALY

**Yamaha Musica Italia S.P.A.  
Combo Division**  
Viale Italia 88, 20020 Lainate (Milano), Italy  
Tel: 02-935-7711

### SPAIN/PORTUGAL

**Yamaha-Hazen Música, S.A.**  
Ctra. de la Coruna km. 17, 200, 28230  
Las Rozas (Madrid), Spain  
Tel: 91-201-0700

### GREECE

**Philippos Nakas S.A. The Music House**  
147 Skiathou Street, 112-55 Athens, Greece  
Tel: 01-228 2160

### SWEDEN

**Yamaha Scandinavia AB**  
J. A. Wettergrens Gata 1  
Box 30053  
S-400 43 Göteborg, Sweden  
Tel: 031 89 34 00

### DENMARK

**YS Copenhagen Liaison Office**  
Generatorvej 8B  
DK-2730 Herlev, Denmark  
Tel: 44 92 49 00

### FINLAND

**F-Musiikki Oy**  
Kluuvikatu 6, P.O. Box 260,  
SF-00101 Helsinki, Finland  
Tel: 09 618511

### NORWAY

**Norsk filial av Yamaha Scandinavia AB**  
Grini Næringspark 1  
N-1345 Østerås, Norway  
Tel: 67 16 77 70

### ICELAND

**Skiðan HF**  
Skeifan 17 P.O. Box 8120  
IS-128 Reykjavik, Iceland  
Tel: 525 5000

### OTHER EUROPEAN COUNTRIES

**Yamaha Music Central Europe GmbH**  
Siemensstraße 22-34, 25462 Rellingen, Germany  
Tel: +49-4101-3030

## AFRICA

**Yamaha Corporation,  
Asia-Pacific Music Marketing Group**  
Nakazawa-cho 10-1, Hamamatsu, Japan 430-8650  
Tel: +81-53-460-2312

## MIDDLE EAST

### TURKEY/CYPRUS

**Yamaha Music Central Europe GmbH**  
Siemensstraße 22-34, 25462 Rellingen, Germany  
Tel: 04101-3030

### OTHER COUNTRIES

**Yamaha Music Gulf FZE**  
LB21-128 Jebel Ali Freezone  
P.O.Box 17328, Dubai, U.A.E.  
Tel: +971-4-881-5868

## ASIA

### HONG KONG

**Tom Lee Music Co., Ltd.**  
11/F., Silvercord Tower 1, 30 Canton Road,  
Tsimshatsui, Kowloon, Hong Kong  
Tel: 2737-7688

### INDONESIA

**PT. Yamaha Music Indonesia (Distributor)  
PT. Nusantik**  
Gedung Yamaha Music Center, Jalan Jend. Gatot  
Subroto Kav. 4, Jakarta 12930, Indonesia  
Tel: 21-520-2577

### KOREA

**Yamaha Music Korea Ltd.**  
Tong-Yang Securities Bldg. 16F 23-8 Yoido-dong,  
Yongdungpo-ku, Seoul, Korea  
Tel: 02-3770-0661

### MALAYSIA

**Yamaha Music Malaysia, Sdn., Bhd.**  
Lot 8, Jalan Perbandaran, 47301 Kelana Jaya,  
Petaling Jaya, Selangor, Malaysia  
Tel: 3-703-0900

### PHILIPPINES

**Yupangco Music Corporation**  
339 Gil J. Puyat Avenue, P.O. Box 885 MCPO,  
Makati, Metro Manila, Philippines  
Tel: 819-7551

### SINGAPORE

**Yamaha Music Asia Pte., Ltd.**  
11 Ubi Road #06-00, Meiban Industrial Building,  
Singapore  
Tel: 65-747-4374

### TAIWAN

**Yamaha KHS Music Co., Ltd.**  
3F, #6, Sec.2, Nan Jing E. Rd. Taipei.  
Taiwan 104, R.O.C.  
Tel: 02-2511-8688

### THAILAND

**Siam Music Yamaha Co., Ltd.**  
121/60-61 RS Tower 17th Floor,  
Ratchadaphisek RD., Dindaeng,  
Bangkok 10320, Thailand  
Tel: 02-641-2951

### THE PEOPLE'S REPUBLIC OF CHINA AND OTHER ASIAN COUNTRIES

**Yamaha Corporation,  
Asia-Pacific Music Marketing Group**  
Nakazawa-cho 10-1, Hamamatsu, Japan 430-8650  
Tel: +81-53-460-2317

## OCEANIA

### AUSTRALIA

**Yamaha Music Australia Pty. Ltd.**  
Level 1, 99 Queensbridge Street, Southbank,  
Victoria 3006, Australia  
Tel: 3-9693-5111

### NEW ZEALAND

**Music Houses of N.Z. Ltd.**  
146/148 Captain Springs Road, Te Papapa,  
Auckland, New Zealand  
Tel: 9-634-0099

### COUNTRIES AND TRUST TERRITORIES IN PACIFIC OCEAN

**Yamaha Corporation,  
Asia-Pacific Music Marketing Group**  
Nakazawa-cho 10-1, Hamamatsu, Japan 430-8650  
Tel: +81-53-460-2312

**HEAD OFFICE** Yamaha Corporation, Pro Audio & Digital Musical Instrument Division  
Nakazawa-cho 10-1, Hamamatsu, Japan 430-8650  
Tel: +81-53-460-3273



*Clavinova Web site (English only)*

**<http://www.yamahaclavinova.com/>**

*Yamaha Manual Library*

**<http://www2.yamaha.co.jp/manual/english/>**