

# YAMAHA RX-V990

---

*Natural Sound Stereo Receiver*

*Récepteur stéréo “Son Naturel”*

---

**OWNER'S MANUAL  
MODE D'EMPLOI**

# SAFETY INSTRUCTIONS



**CAUTION**

RISK OF ELECTRIC SHOCK  
DO NOT OPEN



CAUTION: TO REDUCE THE RISK OF ELECTRIC SHOCK, DO NOT REMOVE COVER (OR BACK). NO USER-SERVICEABLE PARTS INSIDE. REFER SERVICING TO QUALIFIED SERVICE PERSONNEL.

• Explanation of Graphical Symbols



The lightning flash with arrowhead symbol, within an equilateral triangle, is intended to alert you to the presence of uninsulated "dangerous voltage" within the product's enclosure that may be of sufficient magnitude to constitute a risk of electric shock to persons.



The exclamation point within an equilateral triangle is intended to alert you to the presence of important operating and maintenance (servicing) instructions in the literature accompanying the appliance.

**WARNING**  
TO REDUCE THE RISK OF FIRE OR ELECTRIC SHOCK, DO NOT EXPOSE THIS UNIT TO RAIN OR MOISTURE.

**IMPORTANT!**  
Please record the serial number of this unit in the space below.

Model:  
Serial No.:

The serial number is located on the rear of the unit. Retain this Owner's Manual in a safe place for future reference.

- 1 Read Instructions — All the safety and operating instructions should be read before the unit is operated.
- 2 Retain Instructions — The safety and operating instructions should be retained for future reference.
- 3 Heed Warnings — All warnings on the unit and in the operating instructions should be adhered to.
- 4 Follow Instructions — All operating and other instructions should be followed.
- 5 Water and Moisture — The unit should not be used near water – for example, near a bathtub, washbowl, kitchen sink, laundry tub, in a wet basement, or near a swimming pool, etc.
- 6 Carts and Stands — The unit should be used only with a cart or stand that is recommended by the manufacturer.
- 6A An unit and cart combination should be moved with care. Quick stops, excessive force, and uneven surfaces may cause the unit and cart combination to overturn.



- 7 Wall or Ceiling Mounting — The unit should be mounted to a wall or ceiling only as recommended by the manufacturer.
- 8 Ventilation — The unit should be situated so that its location or position does not interfere with its proper ventilation. For example, the unit should not be situated on a bed, sofa, rug, or similar surface, that may block the ventilation openings; or placed in a built-in installation, such as a bookcase or cabinet that may impede the flow of air through the ventilation openings.
- 9 Heat — The unit should be situated away from heat sources such as radiators, stoves, or other appliances that produce heat.
- 10 Power Sources — The unit should be connected to a power supply only of the type described in the operating instructions or as marked on the unit.
- 11 Power-Cord Protection — Power-supply cords should be routed so that they are not likely to be walked on or pinched by items placed upon or against them, paying particular attention to cords at plugs, convenience receptacles, and the point where they exit from the unit.
- 12 Cleaning — The unit should be cleaned only as recommended by the manufacturer.
- 13 Nonuse Periods — The power cord of the unit should be unplugged from the outlet when left unused for a long period of time.
- 14 Object and Liquid Entry — Care should be taken so that objects do not fall into and liquids are not spilled into the inside of unit.
- 15 Damage Requiring Service — The unit should be serviced by qualified service personnel when:
  - A. The power-supply cord or the plug has been damaged; or
  - B. Objects have fallen, or liquid has been spilled into the unit; or
  - C. The unit has been exposed to rain; or
  - D. The unit does not appear to operate normally or exhibits a marked change in performance; or
  - E. The unit has been dropped, or the enclosure damaged.
- 16 Servicing — The user should not attempt service the unit beyond those means described in the operating instructions. All other servicing should be referred to qualified service personnel.
- 17 Power Lines — An outdoor antenna should be located away from power lines.
- 18 Grounding or Polarization — Precautions should be taken so that the grounding or polarization is not defeated.

**19 Outdoor Antenna Grounding** — If an outside antenna is connected to this unit, be sure the antenna system is grounded so as to provide some protection against voltage surges and built-up static charges. Article 810 of the National Electrical Code, ANSI/NFPA 70, provides information with regard to proper grounding of the mast and supporting structure, grounding of the lead-in wire to an antenna discharge unit, size of grounding conductors, location of antenna discharge unit, connection to grounding electrodes, and requirements for the grounding electrode.

EXAMPLE OF ANTENNA GROUNDING

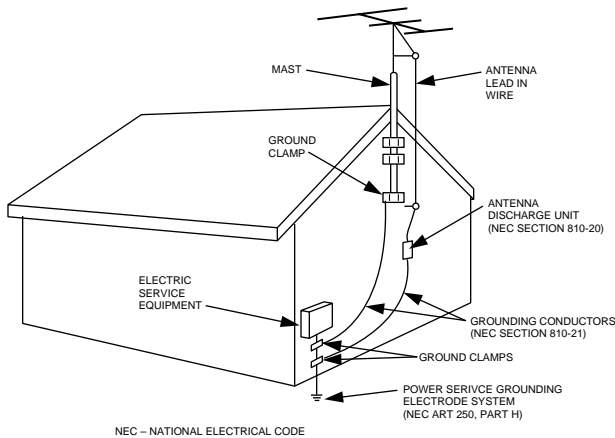

**Note to CATV system installer:**

This reminder is provided to call the CATV system installer's attention to Article 820-40 of the NEC that provides guidelines for proper grounding and, in particular, specifies that the cable ground shall be connected to the grounding system of the building, as close to the point of cable entry as practical.

**CAUTION (FOR CANADA MODEL)**

TO PREVENT ELECTRIC SHOCK, MATHC WIDE BLADE OF PLUG TO WIDE SLOT AND FULLY INSERT.

**FOR CANADIAN CUSTOMERS**

THIS DIGITAL APPARATUS DOES NOT EXCEED THE "CLASS B" LIMITS FOR RADIO NOISE EMISSIONS FROM DIGITAL APPARATUS SET OUT IN THE RADIO INTERFERENCE REGULATIONS OF THE CANADIAN DEPARTMENT OF COMMUNICATIONS.

**FCC INFORMATION**

**1. IMPORTANT NOTICE: DO NOT MODIFY THIS UNIT!** This product, when installed as indicated in the instructions contained in this manual, meets FCC requirements. Modifications not expressly approved by Yamaha may void your authority, granted by the FCC, to use the product.

**2. IMPORTANT:** When connecting this product to accessories and/or another product use only high quality shielded cables. Cable/s supplied with this product **MUST** be used. Follow all installation instructions. Failure to follow instructions could void your FCC authorization to use this product in the USA.

**3. NOTE:** This product has been tested and found to comply with the requirements listed in FCC Regulations, Part 15 for Class "B" digital devices. Compliance with these requirements provides a reasonable level of assurance that your use of this product in a residential environment will not result in harmful interference with other electronic devices.

This equipment generates/uses radio frequencies and, if not installed and used according to the instructions found in the users manual, may cause interference harmful to the operation of other electronic devices.

Compliance with FCC regulations does not guarantee that interference will not occur in all installations. If this product is found to be the source of interference, which can be determined by turning the unit "OFF" and "ON", please try to eliminate the problem by using one of the following measures:

Relocate either this product or the device that is being affected by the interference.

Utilize power outlets that are on different branch (circuit breaker or fuse) circuits or install AC line filter/s.

In the case of radio or TV interference, relocate/reorient the antenna. If the antenna lead-in is 300 ohm ribbon lead, change the lead-in to coaxial type cable.

If these corrective measures do not produce satisfactory results, please contact the local retailer authorized to distribute this type of product. If you can not locate the appropriate retailer, please contact Yamaha Electronics Corp., U.S.A. 6600 Orangethorpe Ave, Buena Park, CA 90620

The above statement apply **ONLY** to those products distributed by Yamaha Corporation of America or its subsidiaries.

## CAUTION: READ THIS BEFORE OPERATING YOUR UNIT

---

- 1 To ensure the finest performance, please read this manual carefully. Keep it in a safe place for future reference.
- 2 Install your unit in a cool, dry, clean place – away from windows, heat sources, and too much vibration, dust, moisture or cold. Avoid sources of hum (transformers, motors). To prevent fire or electrical shock, do not expose to rain and water.
- 3 Do not operate the unit upside-down. It may overheat, possibly causing damage.
- 4 Never open the cabinet. If a foreign object drops into the set, contact your dealer.
- 5 Do not use force on switches, knobs or cords. When moving the set, first turn the unit off. Then gently disconnect the power plug and the cords connecting to other equipment. Never pull the cord itself.
- 6 Do not attempt to clean the unit with chemical solvents; this might damage the finish. Use a clean, dry cloth.
- 7 Always set the volume control to “– ∞” before starting the audio source play: increase the volume gradually to an appropriate level after the play is started.
- 8 To prevent lightning damage, pull out the power cord and remove the antenna cable during an electrical storm.
- 9 Be sure to read the “Troubleshooting” section on common operating errors before concluding that your unit is faulty.
- 10 Do not connect audio equipment to the AC outlets on the rear panel if that equipment requires more power than the outlets are rated to provide.
- 11 When not planning to use this unit for long periods of time (ie., vacation, etc.), disconnect the AC power plug from the wall outlet.

The apparatus is not disconnected from the AC power source as long as it is connected to the wall outlet, even if the apparatus itself is turned off.

## We Want You Listening For A Lifetime

---

YAMAHA and the Electronic Industries Association’s Consumer Electronics Group want you to get the most out of your equipment by playing it at a safe level. One that lets the sound come through loud and clear without annoying blaring or distortion – and, most importantly, without

affecting your sensitive hearing. Since hearing damage from loud sounds is often undetectable until it is too late, YAMAHA and the Electronic Industries Association’s Consumer Electronics Group recommend you to avoid prolonged exposure from excessive volume levels.



---

## Contents

PROFILE OF THIS UNIT .....	7	TUNING OPERATIONS .....	24
SPEAKER SETUP FOR THIS UNIT .....	8	USING THE DIGITAL SOUND FIELD	
CONTROLS AND FUNCTIONS .....	10	PROCESSOR (DSP) .....	28
CONNECTIONS .....	12	SETTING THE SLEEP TIMER .....	33
ADJUSTMENT BEFORE OPERATION .....	18	REMOTE CONTROL TRANSMITTER .....	34
BASIC OPERATIONS .....	21		

# SUPPLIED ACCESSORIES

After unpacking, check that the following parts are contained.

- Remote Control Transmitter

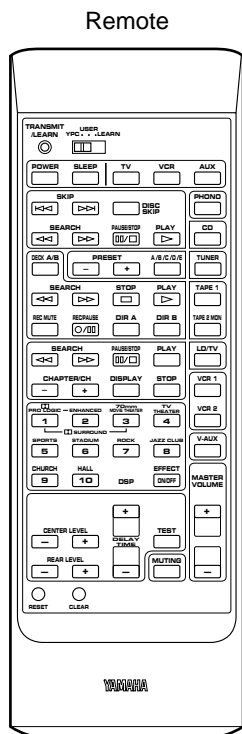

- Indoor FM Antenna

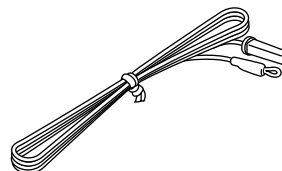

- AM Loop Antenna

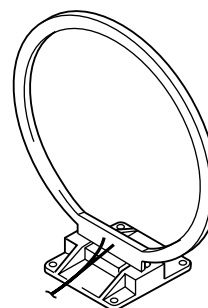

- Batteries (size AA, LR6, UM-3)

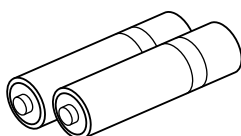

- User Program Sheets

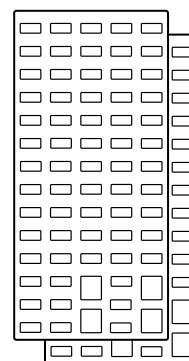

- Adapter for F-type connector

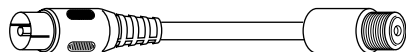

## Features

---

- Five Speaker Configuration
  - Front: 100 W + 100 W (8 $\Omega$ ) RMS Output Power, 0.015% THD, 20-20,000 Hz  
120 W + 120 W (6 $\Omega$ ) RMS Output Power, 0.04% THD, 20-20,000 Hz (USA Model Only)
  - Center: 100 W (8 $\Omega$ ) RMS Output Power, 0.015% THD, 1 kHz
  - Rear: 25 W + 25 W (8 $\Omega$ ) RMS Output Power, 0.08% THD, 1 kHz
- Digital Sound Field Processor
  - 10 Programs including "Cinema DSP" 70mm Movie Theater
- 5 Channel Discrete Input for Dolby Surround Digital AC-3
- Automatic Input Balance Control for Dolby Pro Logic Surround
- Test Tone Generator for Easier Speaker Output Balance Adjustment
- 3 Center Channel Modes (NORMAL/WIDE/PHANTOM)
- 40-Station Random Access Preset Tuning
- Automatic Preset Tuning (FM only)
- Preset Station Shifting Capability (Preset Editing)
- IF Count Direct PLL Synthesizer Tuning System
- Video Signal Input/Output Capability
- SLEEP Timer
- Remote Control Capability
- Program and status messages superimposed on connected video monitor

# PROFILE OF THIS UNIT

You are the proud owner of a Yamaha stereo receiver –an extremely sophisticated audio component. The Digital Sound Field Processor (DSP) built into this unit takes full advantage of Yamaha’s undisputed leadership in the field of digital audio processing to bring you a whole new world of listening experiences. Follow the instructions in this manual carefully when setting up your system, and this unit will sonically transform your room into a totally new listening environments –movie theater, concert hall, and so on. In addition, you get incredible realism from Dolby-encoded video sources using the built-in Dolby Pro Logic Surround Decoder. Please read this owner’s manual carefully and store it in a safe place for later reference.

## Digital Sound Field Processing

What is it that makes live music so good? Today’s advanced sound reproduction technology lets you get extremely close to the sound of a live performance, but chances are you’ll still notice something missing: the acoustic environment of the live concert hall. Extensive research into the exact nature of the sonic reflections that create the ambience of a large hall has made it possible for Yamaha engineers to bring you

this same sound in your own listening room, so you’ll feel all the sound of a live concert.

Furthermore, our technicians, armed with sophisticated measuring equipment, have even made it possible to capture the acoustics of a variety of venues such as an actual concert hall, theater, etc. to allow you to accurately recreate one of several actual live performance environments, all in your own home.

## Dolby Pro Logic Surround

The Dolby Pro Logic Surround Decoder program lets you experience the dramatic realism and impact of Dolby Surround movie theater sound in your own home. Dolby Pro Logic gets its name from its professional-grade steering logic circuitry, which provides greater effective front and rear channel separation for a much higher degree of realism than the “passive” Dolby Surround circuits found in less sophisticated home audio/video equipment. Dolby Pro Logic Surround provides a true center channel, so that there are four independent channels, unlike passive Dolby Surround which has in effect only three channels: left, right, and rear. This center channel allows listeners

seated in even less-than-ideal positions to hear the dialog originating from action on the screen while getting a stereo effect as well.

This Dolby Pro Logic Surround Decoder employs a digital signal processing system. This system increases sound stability at each channel and minimizes crosstalk between channels compared to conventional analog Dolby signal processing.

In addition, this unit features a built-in automatic input balance control. This circuit always presents you the best surround conditions without performing manual adjustments.

## Dolby Pro Logic Surround + DSP

You can also enjoy Dolby Pro Logic with two modes of Digital Sound field processing. These combinations expand the surround effect. One is the “ENHANCED” Dolby Pro Logic Surround which recreates the surround effect of the 35 mm film movie theater. The other is the sound field program “70 mm MOVIE THEATER”. Which recreates the listening experience of a 70mm film theater.

### **CINEMA DSP**

The YAMAHA “CINEMA DSP” logo indicates these programs are created by the combination of Dolby Pro Logic and YAMAHA DSP technology.

## Directional Enhancement Circuit + DSP

The newly featured directional enhancement circuit expands and focuses the digital sound field by emphasizing position of sound.

This effect puts you in the midst of the action, while centering and focusing your attention to the screen. This circuit is available on the sound field program “TV THEATER” and “SPORTS”.

# SPEAKER SETUP FOR THIS UNIT

## SPEAKERS TO BE USED

This unit is designed to provide the best sound-field quality with a fivespeaker configuration. The speakers to be used with this unit will be front speakers, rear speakers, and a center speaker.

The front speakers are used for the main source sound. These are usually a much larger, high-quality loudspeaker than you will use for the surround sound effects. The center speaker is used for the center sound (dialog, etc.) encoded with the Dolby Surround. And the rear speakers are used for special effects that enhance the surround sound. The rear and center speakers do not need to be equal to the front speakers. However, all the speakers should have high enough power handling to accept the maximum output of this unit.

## SPEAKER CONFIGURATION

### Five-Speaker Configuration

This configuration is the most effective and recommended one. In this configuration, the center speaker is used for dialog when you select the digital sound field program DOLBY PRO LOGIC, DOLBY PRO LOGIC ENHANCED, 70mm MOVIE THEATER, TV THEATER, or SPORTS.

- Set the center channel mode to the "NORMAL" or "WIDE" position. (For details, refer to page 19.)

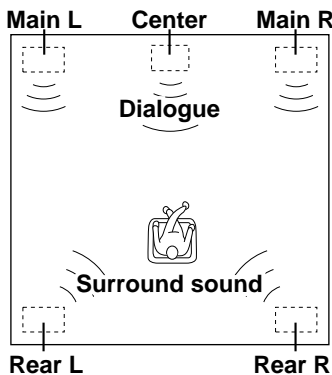

### Four-Speaker Configuration

The center speaker is not used in this configuration. If the digital sound field program DOLBY PRO LOGIC, DOLBY PRO LOGIC ENHANCED, 70mm MOVIE THEATER, TV THEATER, or SPORTS is selected, the center sound along with the front effects are output from the left and the right front speakers. However, the sound effect of other programs can be the same as that of the other configurations.

- Be sure to set the center channel mode to the "PHANTOM" position. (For details, refer to page 19.)

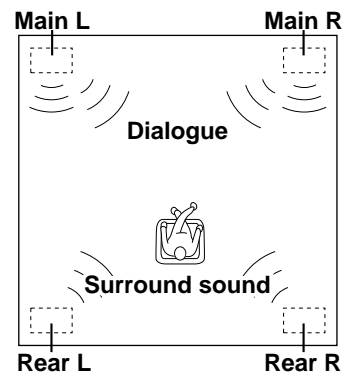



## SPEAKER PLACEMENT

The recommended speaker configuration, the five-speaker configuration, will require two speaker pairs: front speakers and rear speakers, plus a center speaker. When you place these speakers, refer to the following:

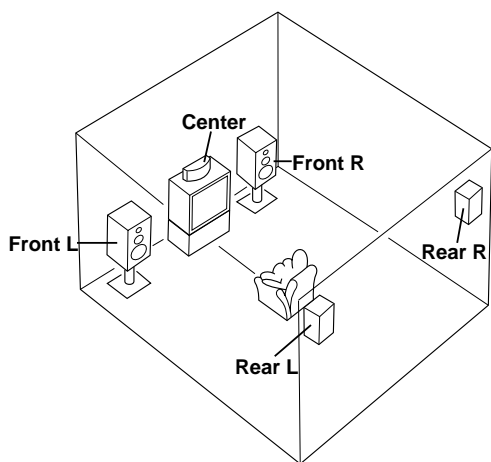

- Front:** In normal position. (The position of a standard stereo speaker setup)
- Center:** Precisely between the front speakers. (To avoid interference with TV sets, use a magnetically shielded speaker.) When two center speakers are used, place these to the right and left of your TV set or video monitor.
- Rear:** Behind your listening position, facing slightly inward. Nearly six feet (approx. 1.8 m) up from the floor.

# CONTROLS AND FUNCTIONS

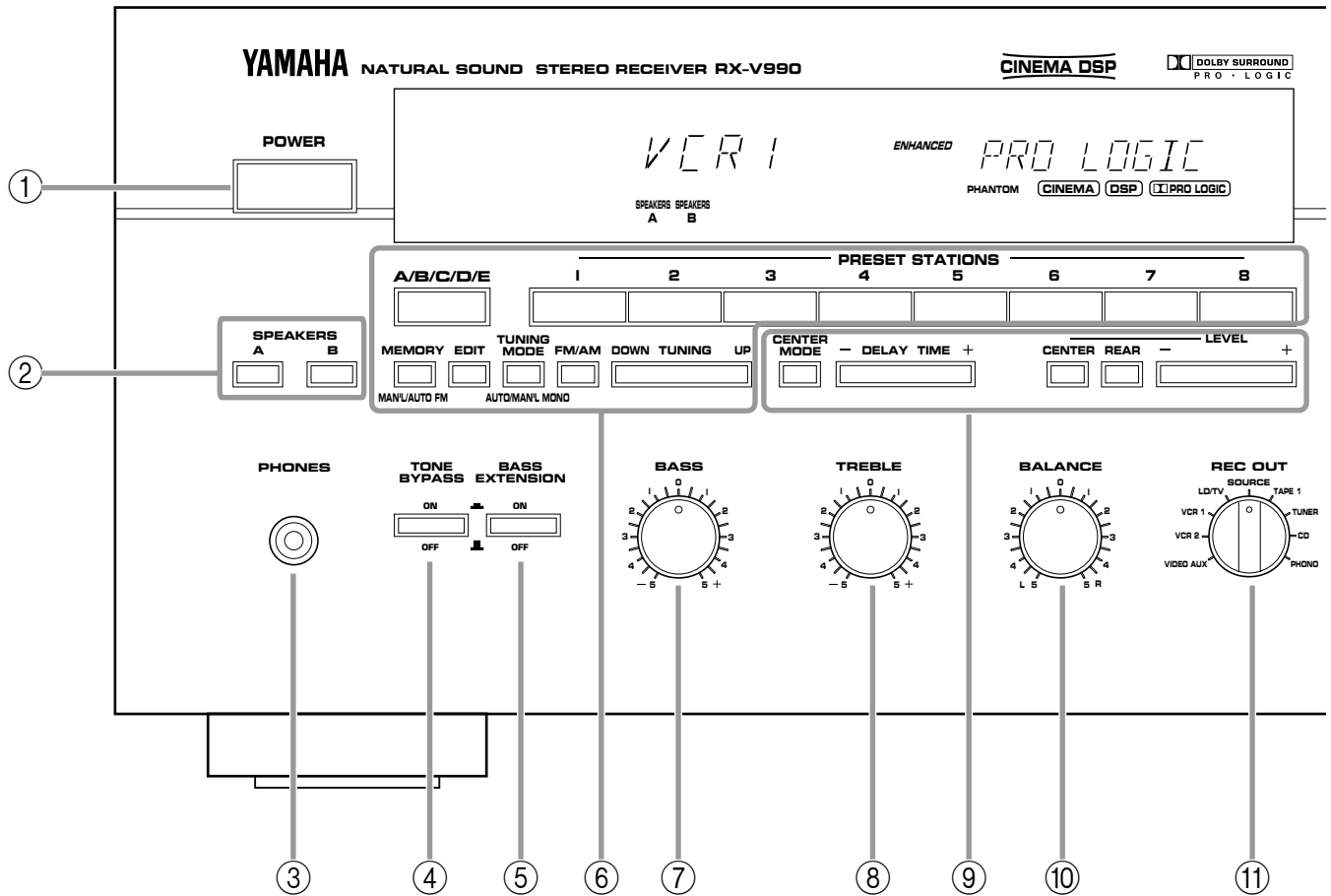

## ① POWER

Press to turn the RX-V990 on and off.

## ② SPEAKERS A, B

Press button A or B to select a set of speakers. (Press both buttons to select two sets of speakers, or leave them off for headphone use.)

## ③ PHONES

Connect a set of headphones for private listening. (Turn off the speakers ② and the Digital Sound Field Processor ⑭. See page 23 for details; turn the volume down to protect your hearing.)

## ④ TONE BYPASS

Press to bypass the Treble, and Bass controls (to evaluate tone enhancements. See page 23 for details).

## ⑤ BASS EXTENSION

Press to boost the low end frequencies to increase the sound of the bass. See page 23 for details.

## ⑥ Tuner Section

Use the Tuner controls to store and select up to 40 AM or FM preset stations.

**A/B/C/D/E** - Repeatedly press this button to turn through pages A through E to enter, edit, or select preset stations in memory. Each page offers 8 presets.

**PRESET STATIONS** - Press button 1 through 8 to access any of the 40 preset stations (used in conjunction with the A/B/C/D/E button).

**MEMORY** - Press to place a new preset station in memory.

**EDIT** - Press to edit preset stations.

**TUNING MODE** - Press to select the tuning mode : Automatic or Manual.

**FM/AM** - Press to select FM or AM radio reception.

**TUNING** - Press "Up" or "Down" to tune to the frequency of the radio station you desire.

## ⑦ BASS

Turn to increase or decrease the low frequencies (bass). See page 23 for details.

## ⑧ TREBLE

Turn to increase or decrease the high frequencies (treble). See page 23 for details.

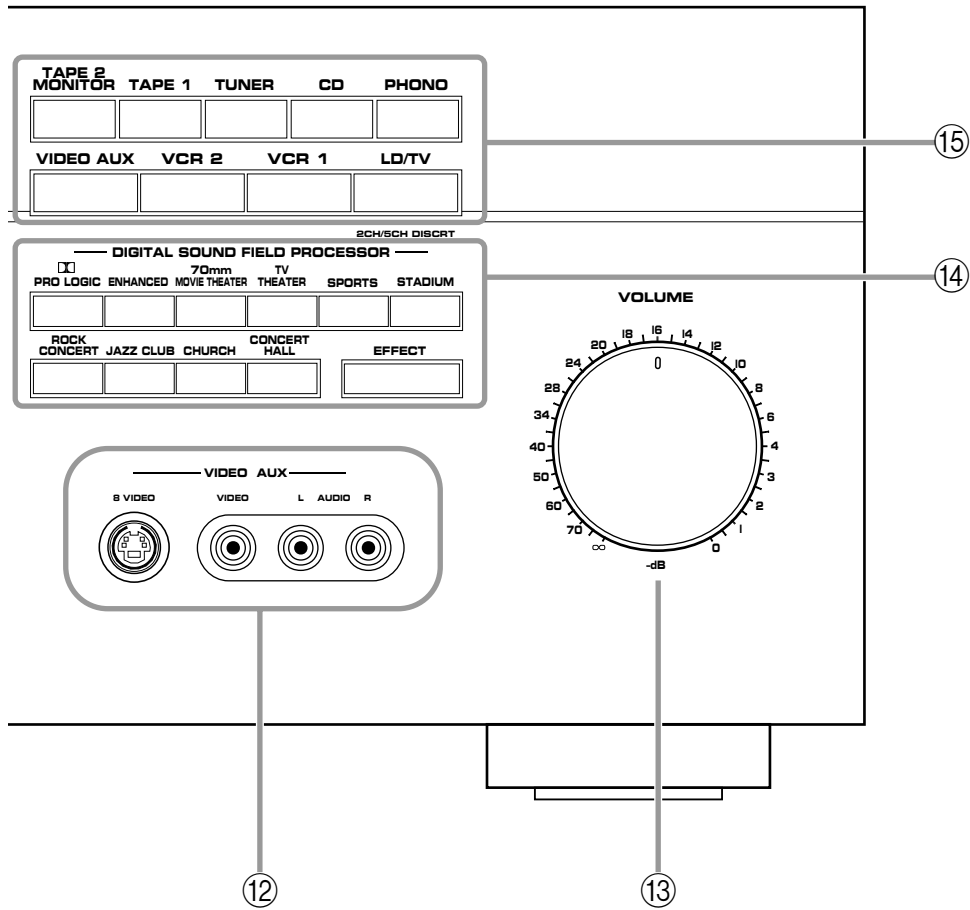

⑨ **DSP Adjustment Control Section**

**CENTER MODE** - When you are using Dolby Pro-Logic, this button selects one of the three center channel modes.

**DELAY TIME** - Increase (+) or decrease (-) the delay time for each sound field ⑭.

**LEVEL (CENTER, REAR)** - Adjust the level of the Center and Rear channels to achieve the best sound.

⑩ **BALANCE**

Turn to adjust the relative volume of the left and right Front channels. See page 23 for details.

⑪ **REC OUT Selector**

Use the Rec Out Selector to choose the source you want to record. You can listen to another source using the Input Selector ⑮ while recording. Set the Rec Out Selector to "Source" when you want to simultaneously record and listen to the input source.

⑫ **VIDEO AUX Input**

Connect a video source (camcorder, etc) to this convenient front panel input. See page 16 for details.

⑬ **VOLUME**

Turn to adjust the master volume level of all channels.

⑭ **DIGITAL SOUND FIELD PROCESSOR**

Press the "Effect" button, then press one of the 10 DSP surround buttons to simulate various acoustic environments. To turn off the surround sound, press the "Effect" button again. See page 28 for details.

⑮ **Input Selector**

Press one of the input select buttons to select the source you wish to hear and watch. To listen to a 5CH DISCRT SOURCE, press the LD/TV button so that "5CH DISCRT" appears on the display. See page 30 for details.

# CONNECTIONS

## CAUTION

Before attempting to make any connections to or from this unit, be sure to first switch OFF the power to this unit and to any other components to which connections are being made.

## CONNECTIONS WITH OTHER COMPONENTS

When making connections between this unit and other components, be sure all connections are made correctly, that is to say L (left) to L, R (right) to R, "+" to "+" and "-" to "-". Also, refer to the owner's manual for each component to be connected to this unit.

- \* If you have YAMAHA audio/video unit numbered as 1, 2, 3, etc. on the rear panel, connections can be made easily by making sure to connect the output ( or input) terminals of each unit to the same-numbered terminals of this unit.

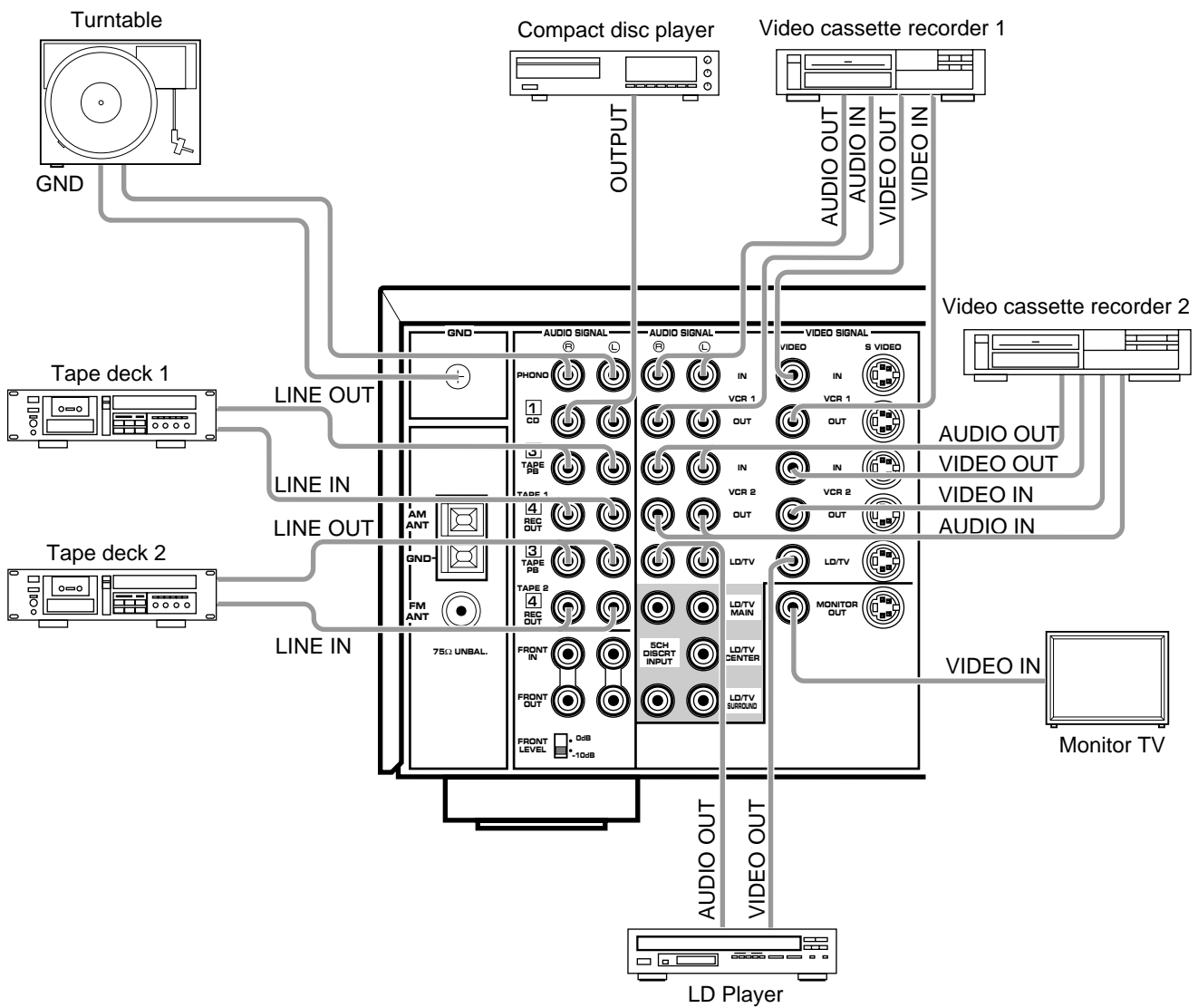

# CONNECTING SPEAKERS

Connect the respective speakers to this unit as shown below:

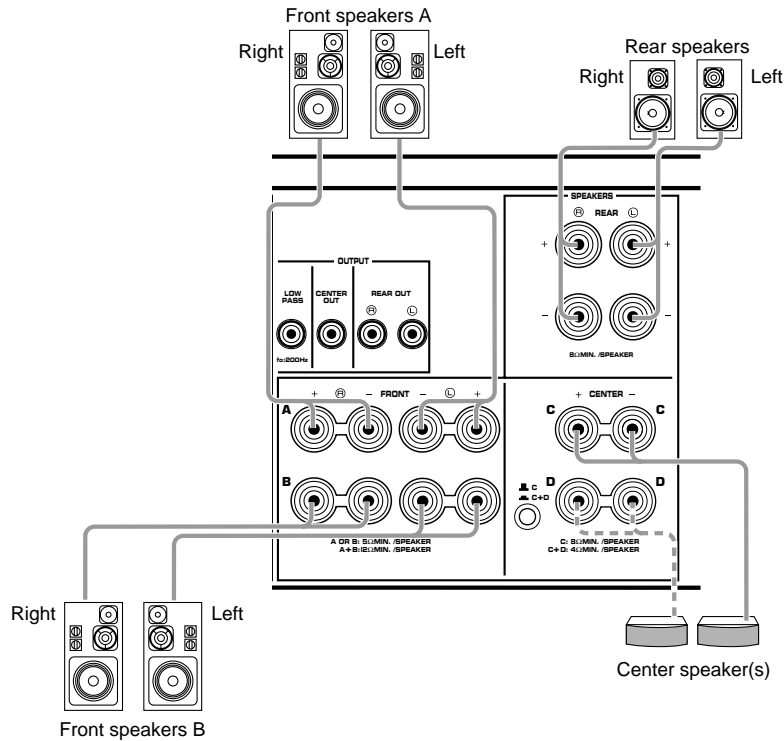

**Note on front speaker connection:**

One or two speaker systems can be connected to this unit. If you connect only one speaker system, connect it to either the **SPEAKERS A** or **B** terminals.

**Note on center speaker connection:**

One or two center speakers can be connected to this unit. If you cannot place the center speaker on or under the TV, it is recommended to use two center speakers and place them on both sides of the TV to orient the center sound at the center position. When connecting two center speakers, be sure to press the **CENTER** speaker switch into the “**C+D**” position (▲). When you use a single center speaker, set the switch to the “**C**” position (■).

**How to Connect:**

Connect the **SPEAKERS** terminals to your speakers with wire of the proper gauge, cut as short as possible. If the connections are faulty, no sound will be heard from the speakers. Make sure that the polarity of the speaker wires is correct, that is, + and – markings are observed. If these wires are reversed, the sound will be unnatural and will lack bass.

**CAUTION**  
Do not let the bare speaker wires touch each other and do not let them touch the metal parts of this unit. This could damage this unit and/or the speakers.

**Note:**

Use speakers with the specified impedance shown on the rear of this unit.

For connecting to the **SPEAKER** terminals

Red: positive (+)  
Black: negative (-)

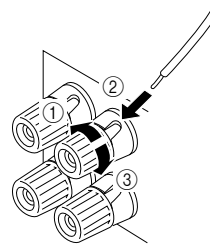

- ① Unscrew the knob.
- ② Insert the bare wire. [Remove approx. 5mm (1/4”) insulation from the speaker wires.]
- ③ Tighten the knob and secure the wire.

Banana Plug connections are also possible. Simply insert the Banana Plug connector into the corresponding terminal. (Not available on Singapore model.)

**Note:**

Use only single type banana plug cable.

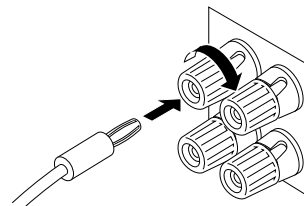

## ABOUT THE ACCESSORY TERMINALS

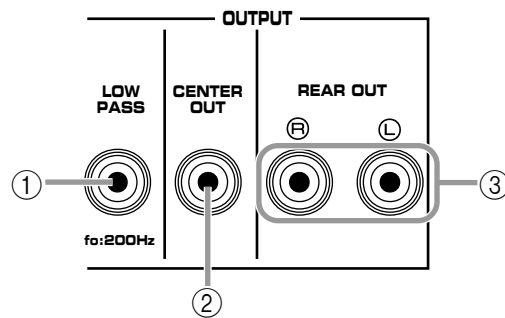

### ① LOW PASS terminal

This terminal is for output to a monaural amplifier driving a subwoofer. Frequencies above 200 Hz are filtered out so that only the bass range remains. The output signal is from the front and center channels.

You may wish to add a subwoofer to reinforce the bass frequencies.

Connect the LOW PASS terminal to the INPUT terminal of the subwoofer amplifier, and connect the speaker terminals of the subwoofer amplifier to the subwoofer.

With some subwoofers, including the Yamaha Active Servo Processing Subwoofer System, the amplifier and subwoofer are in the same unit.

### ② CENTER OUTPUT terminal

This terminal is for center channel line output. There is no connection to this terminal when you use the built-in amplifier.

However, if you drive a center speaker with an external power amplifier, connect the input terminal of the external amplifier to this terminal.

### ③ REAR OUTPUT terminals

These terminals are for rear channel line output. There is no connection to these terminals when you use the built-in amplifier.

However, if you drive rear speakers with an external stereo power amplifier, connect the input terminals of the external amplifier (MAIN IN or AUX terminals of a power amplifier or an integrated amplifier) to these terminals.

### GND terminal (For turntable use)

Connecting the ground wire of the turntable to this terminal will normally minimize hum. In some cases, better results may be obtained with the ground wire disconnected.

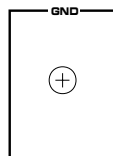

### AC OUTLETS

2 SWITCHED OUTLETS and 1 UNSWITCHED OUTLET (USA, Canada models)

Use these to connect the power cords from your components to this unit.

The power to the **SWITCHED** outlets is controlled by this unit's **POWER** switch or the provided remote control transmitter's **POWER** key. These outlets will supply power to any connected component whenever this unit is turned on.

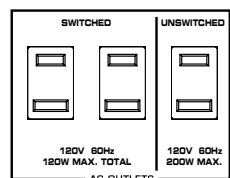

The maximum power (total power consumption of components) that can be connected to the **SWITCHED** AC OUTLET(S) is 120 watts.

The power to the **UNSWITCHED** outlets cannot be controlled by this unit's **POWER** switch or the provided remote control transmitter's **POWER** key. (USA, Canada models only).

The maximum power (power consumption of component) that can be connected to the **UNSWITCHED** AC OUTLET is 200 watts (USA model), 180 watts (Canada model).

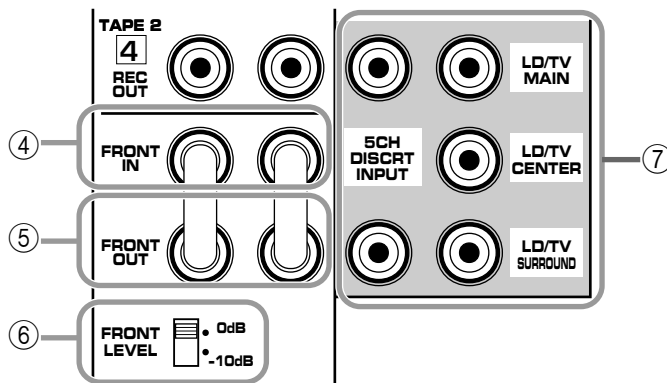

#### ④ FRONT CH — MAIN IN terminals

These terminals are for line input to the built-in front channel amplifier. Leave the jumper bars connected to the PRE OUT terminals when you use the built-in amplifier.

However, if you drive front speakers with an external stereo power amplifier, remove the jumper bars.

#### ⑤ FRONT CH — PRE OUT terminals

These terminals are for front main channel line output. Leave the jumper bars connected to the MAIN IN terminals when you use the built-in amplifier.

However, if you drive front speakers with an external stereo power amplifier, remove the jumper bars and connect the input terminals of the external amplifier (MAIN IN or AUX terminals of a power amplifier or an integrated amplifier) to these terminals.

#### ⑥ FRONT LEVEL switch

Normally set to "0 dB". If desired, you can decrease the output level at the FRONT SPEAKERS terminals by 10 dB by setting this switch to "-10 dB".

#### ⑦ 5CH DISCRT INPUT terminals

These terminals are used with a Dolby Surround AC-3 decoder. Connect the main audio output of the decoder to the LD/TV MAIN input terminals, the center channel audio output to the LD/TV CENTER input terminal, and the surround audio output to the LD/TV SURROUND input terminals.

#### Note:

*The 5CH DISCRT INPUT terminals are for use with an AC-3 decoder.*

*When you use a Dolby Surround AC-3 decoder, the LFE (Low Frequency Effect channel) signal coming from the AC-3 decoder to this unit must be mixed with the main output signal. Refer to your AC-3 decoder's operating manual for information about mixing these signals mode.*

## CONNECTING S VIDEO TERMINALS

If your video cassette recorder, video disc player, monitor, etc., are equipped with "S" (high-resolution) video terminals, connect them to this unit's S VIDEO terminals. Otherwise, use the composite video terminals of the unit.

**Note:**

- If video signals are sent to both the S VIDEO input and composite input terminals, the input signals will be sent to the respective S VIDEO output and composite output terminals independently.

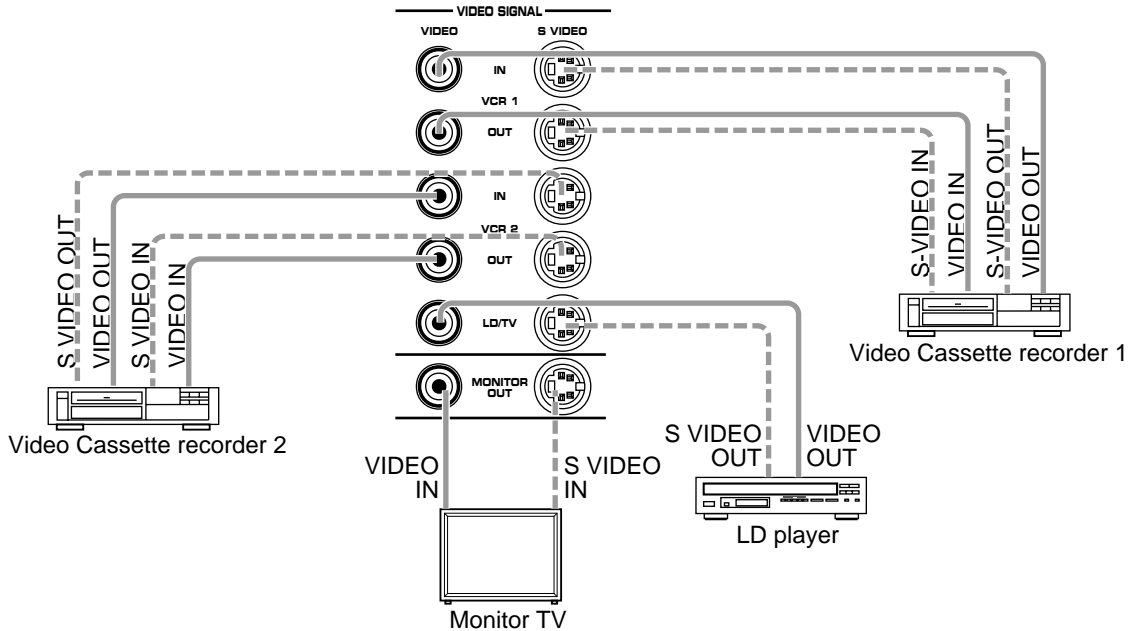

### ON SCREEN DISPLAY

If you connect a video cassette recorder, video disc player, monitor, etc., to this unit, you can display DSP program names and information about the other settings and adjustments on the video monitor screen. This information is superimposed over the video image.

If there is no program material on the monitor, the information will be displayed over a monochromatic background.

**Notes:**

- If you use a video monitor that is connected to both the S VIDEO and composite terminals, the screen display information is only output from the S VIDEO terminals.
- When no video signal is input to any of the S VIDEO or composite video input terminals, the screen display information is output from the S VIDEO and composite MONITOR OUT terminals with a monochromatic background.

## CONNECTING TO VIDEO AUX TERMINALS (FRONT PANEL)

These terminals are used to connect any video input source such as a camcorder to this unit.

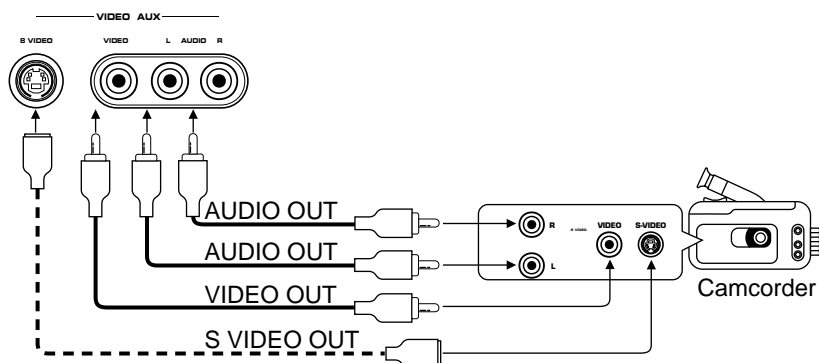



# ANTENNA CONNECTIONS

- Each antenna should be connected to the designated terminals correctly, referring to the following diagram.
- Both AM and FM indoor antennas are included with this unit. In general, these antennas will probably provide sufficient signal strength. Nevertheless, a properly installed outdoor antenna will give clearer reception than an indoor one. If you experience poor reception quality, an outdoor antenna may result in improvement.

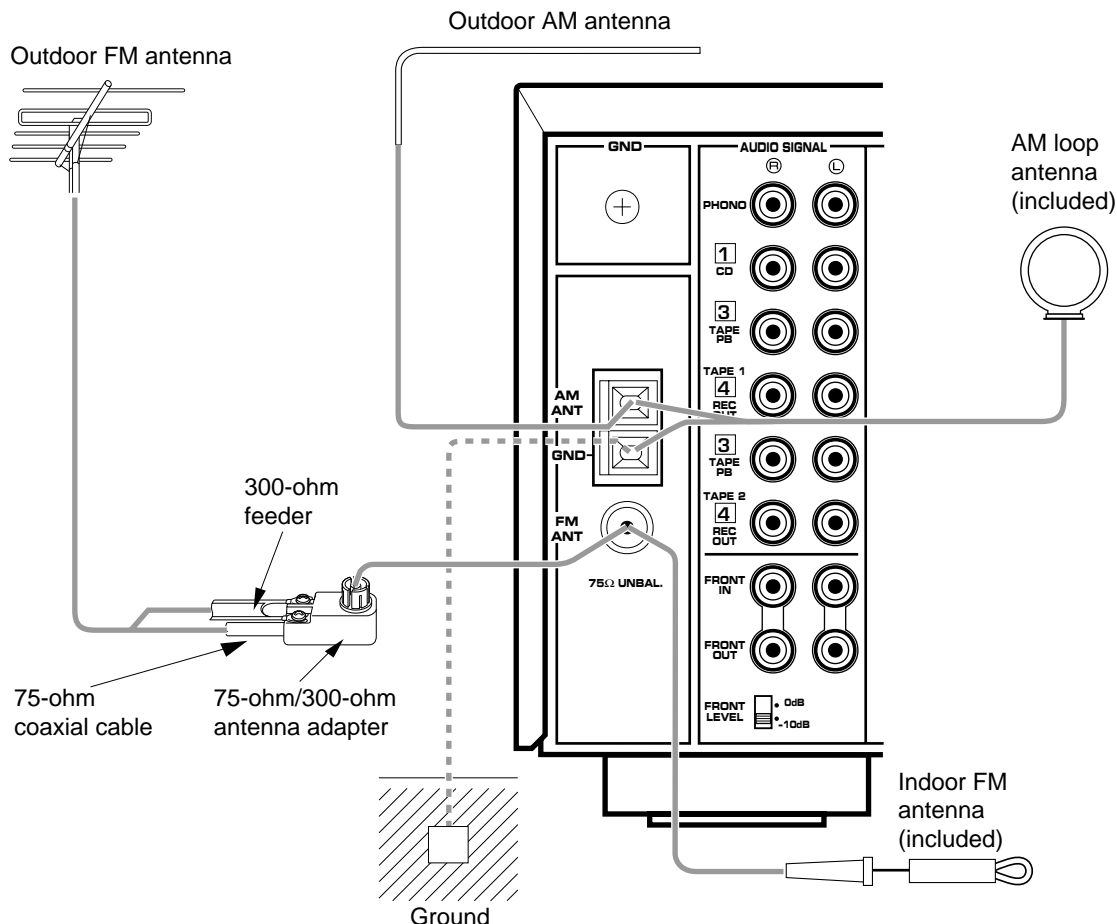

## Connecting the AM loop antenna

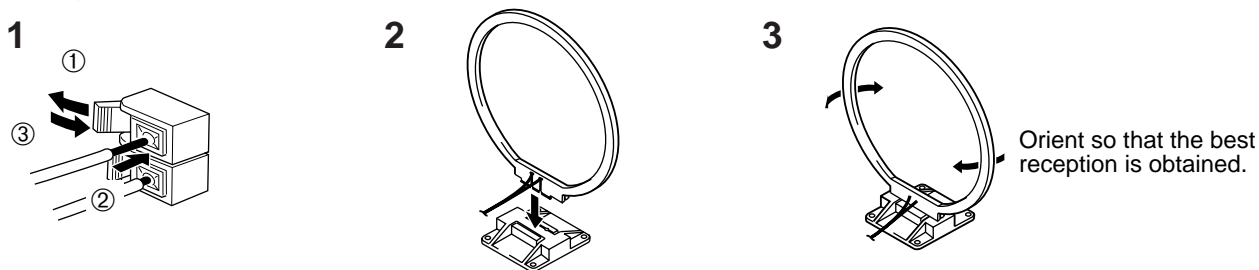

- The AM loop antenna should be placed apart from the main unit. The antenna may be hung on a wall.
- The AM loop antenna should be kept connected, even if an outdoor AM antenna is connected to this unit.

## GND terminal

For maximum safety and minimum interference, connect the **GND** terminal to a good earth ground. A good earth ground is a metal stake driven into moist earth.

## Notes:

- When connecting the indoor FM antenna, insert its connector into the FM ANT terminal firmly.
- If you need an outdoor FM antenna to improve FM reception quality, either 300-ohm feeder or coaxial cable may be used. In locations troubled by electrical interference, coaxial cable is preferable.

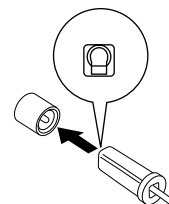

# ADJUSTMENT BEFORE OPERATION

## SPEAKER BALANCE ADJUSTMENT

This procedure lets you adjust the sound output level balance between the front, center, and rear speakers using the built-in test tone generator. With this adjustment, the sound output level heard at the listening position will be the same from each speaker. This is important for the best performance of the digital sound field processor. The adjustment of each speaker output level should be done at your listening position with the remote control transmitter. Otherwise, the result may not be satisfactory.

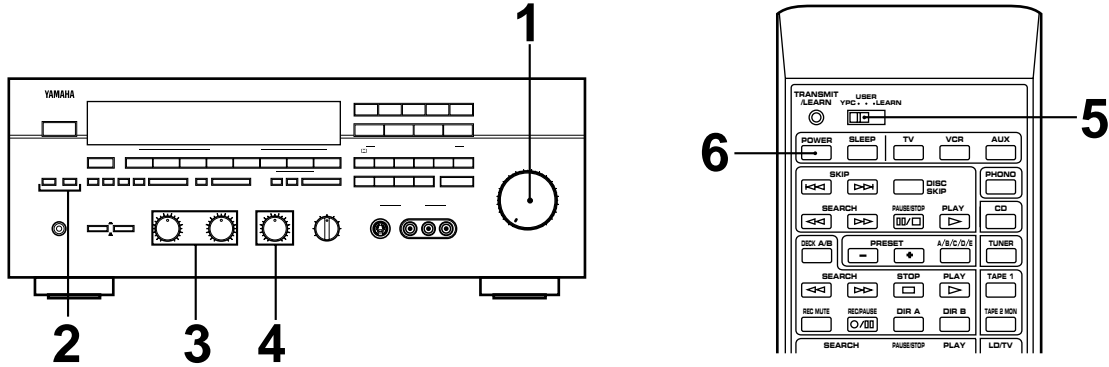

\* If you have a video monitor connected to this unit, you should use it to display the on screen information. The easy-to-read information will help you to perform this adjustment.

### Note:

Before adjustment, make sure that the mute circuit is not engaged. While mute is engaged, no sound will be heard and an indicator on the master VOLUME control flashes. See page 23 for details.

- 1** Set to the “∞” position.

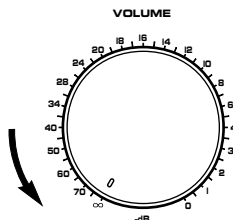

- 2** Set to the “0” position.

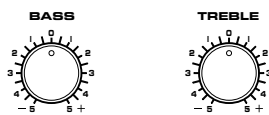

- 3** Set to the “0” position.



- 4** Set the remote YPC-USER-LEARN switch to the “YPC” position.

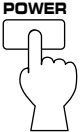

For detailed information about the remote control transmitter, refer to “REMOTE CONTROL TRANSMITTER” on page 34.

- 5**
- 
- Press the POWER switch to turn on the power.

- 6** Select the main speakers to be used.



- If you use two main speaker systems, press both the A and B switches.

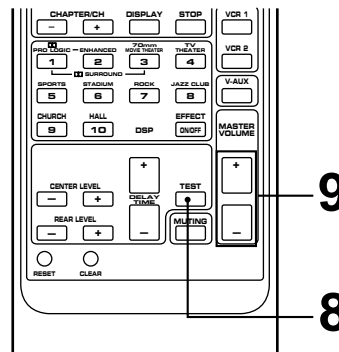
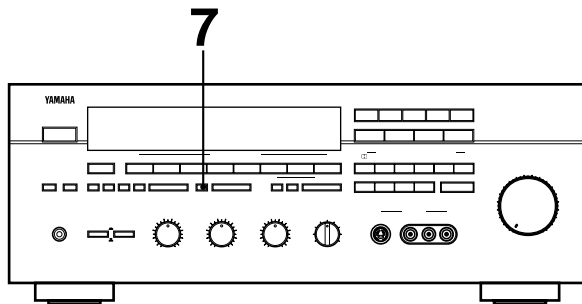

**7** Select the center channel output mode according to your speaker configuration.  
(Refer to "SPEAKER CONFIGURATION" on page 8.)

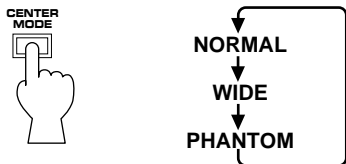

**8** Press the TEST button to run the Dolby test.



**9** **MASTER VOLUME** Turn up the volume using the remote control transmitter. You will hear a test tone (like pink noise) from the left front speaker, then the center speaker, then the right front speaker, and then the rear speakers, for about two seconds each. The display changes as shown below.

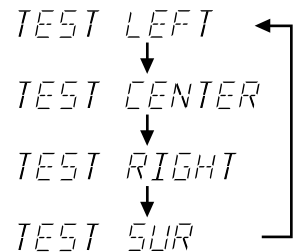
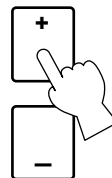

- If your video monitor is on, the state of the test tone output is also shown by an image of an audio listening room on the screen.
- The test tone from the left rear speaker and the right rear speaker will be heard at the same time.

In step 7, when you select the center mode, note the following.

**Five speaker configuration**

**NORMAL:** Select this mode when you use a center speaker that is smaller than the front main speakers. In this mode, the bass tone will be output from the front speakers.

**WIDE:** Select this mode when your center speakers are approximately the same size as the front speakers.

**Four speaker configuration**

**PHANTOM:** Select this mode when you do not have a center speaker. The center channel sound will be output from the left and right front speakers.

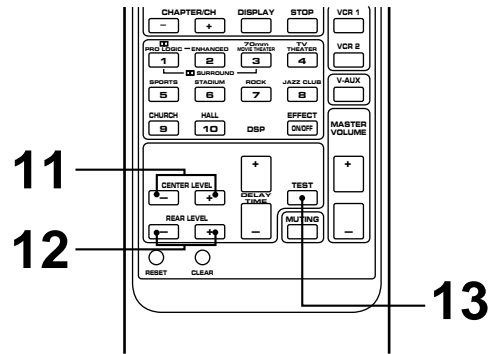
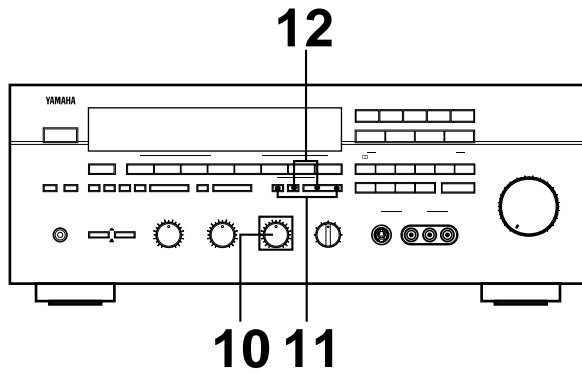

**10** Adjust the BALANCE control so that the test tone sound output level of the left front speaker and the right front speaker are the same.



**11** Adjust the test tone sound output level of the center speaker to be at the same level as that of the front speakers with the CENTER LEVEL keys.

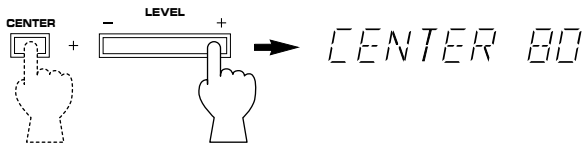

**12** Adjust the sound output level of the rear speakers to be at the same level as that of the front speakers with the REAR LEVEL keys.

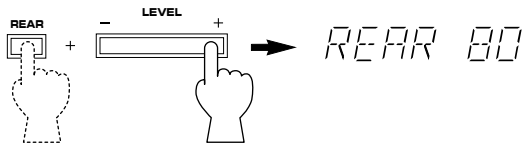

**13** Cancel the test tone.

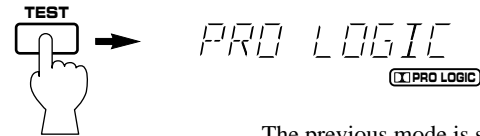

The previous mode is selected.

**Notes:**

- Once you have completed these adjustments, you can adjust whole sound level on your audio system by using the VOLUME control (or the MASTER VOLUME keys on the remote control transmitter).
- If you use external power amplifiers, their volume controls may also need to be adjusted to achieve the proper balance.

If there is insufficient sound output from the center and rear speakers, you may decrease the front speaker output level by setting the FRONT LEVEL switch on the rear panel to “-10 dB”.

**Note:**

- If the center channel mode is in the “PHANTOM” position, the sound output level of the center speaker cannot be adjusted. This is because in this mode, the center sound is automatically output from the left and right front speakers.
- If you press the LEVEL +/- switch without previously pressing the CENTER, or REAR switch, the last channel selected will be changed.

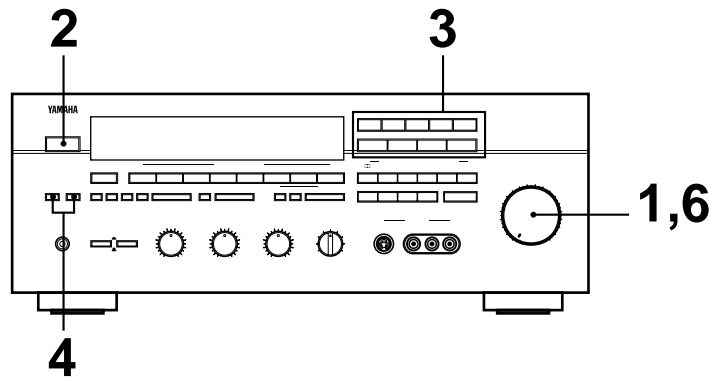

## To play a source

- 1** Set to the “∞” position.

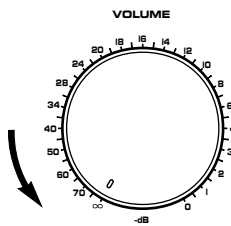

- 2** Press the POWER switch to turn on the power.

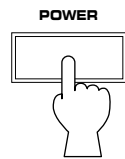

- 3** Select the desired input source by using the input selector buttons. (For video sources, turn the video monitor ON.)

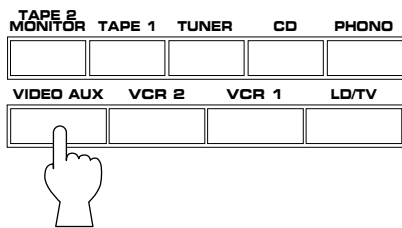

- The name of the selected input source will appear on the display.

- 4** Select the front speakers to be used.



- If you use two front speaker systems, press both the A and B switches.

- 5** Play the source. (For detailed information on the tuning operation, refer to page 24.)

- 6** Adjust to the desired output level.

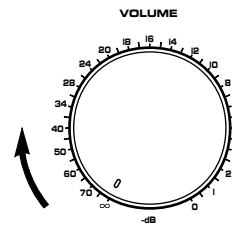

If desired, adjust the BASS, TREBLE, BALANCE controls, etc. (refer to page 23) and use the digital sound field processor. (Refer to page 28.)

### Notes on using the input selector buttons

- Note that pressing on each input selector button selects the source which is connected to the corresponding input terminals on the rear panel.
- To select the source connected to the VIDEO AUX terminals on the front panel, press VIDEO AUX.
- The selection of TAPE 2 MONITOR cannot be canceled by pressing another input selector button. To cancel it, press TAPE 2 MONITOR again. When you select a button other than TAPE 2 MONITOR, make sure that TAPE 2 MONITOR is not accidentally selected as well.
- If you select the input selector button for a video source without canceling the selection of TAPE 2 MONITOR, the playback result will be the video image from the video source and the sound from the audio tape.
- Once you play a video source, its video image will not be interrupted even if the input selector button for an audio source is selected.
- For the LD/TV input selector button, refer to Page 30.

### To turn off the power

Press the POWER switch again.

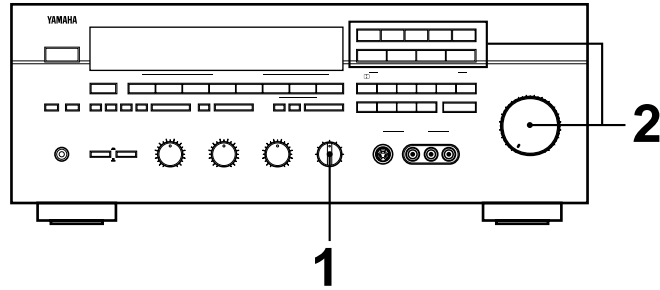

### To record a source to tape (or dub from tape to tape)

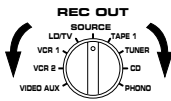
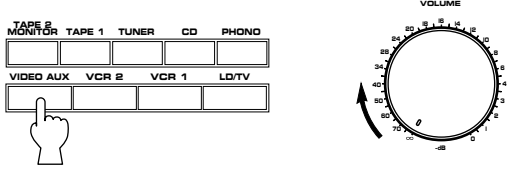
<p><b>1</b> Select the source to be recorded.</p> 
<p><b>2</b> Play the source and press the corresponding input selector, then turn the VOLUME control up to confirm the input source. (For detailed information on the tuning operations, refer to page 24.)</p> 
<p><b>3</b> Set the tape deck or VCR to the recording mode.</p>
<p><b>4</b> To monitor a source selected by the REC OUT selector, press the corresponding input selector button.</p>

**Note:**

- When the REC OUT selector is set to "SOURCE", the source selected by the input selector buttons is output through the TAPE 1-REC OUT, the TAPE 2-REC OUT, the VCR 1-OUT, and the VCR 2-OUT terminals.
- When the REC OUT selector is set to something other than "SOURCE" and you press an input selector button other than the one you pressed in step 2, the recording source will not be changed and you can enjoy another source while recording.
- To record from tape deck 2, set the REC OUT selector to SOURCE, and press the TAPE 2/MONITOR input selector.
- If the tape deck connected to the TAPE 2 REC OUT terminal has 3-head monitoring capability, you can monitor the signal just recorded on the tape by pressing the TAPE 2/MONITOR switch.
- DSP, VOLUME, BASS, TREBLE and BALANCE control settings have no effect on the material being recorded.
- Signals connected to the 5CH DISCRT INPUT are not output to the tape decks or video recorders. To record the signals from an LD player, you must connect the player to the LD/TV terminals.

### Selecting the SPEAKERS system

Because one or two speaker systems (as front speakers) can be connected to this unit, the SPEAKERS switches allow you to select speaker system A or B, or both at once.

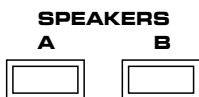

### Adjusting the BALANCE control

Adjust the balance of the output volume to the left and right speakers to compensate for sound imbalance caused by speaker location or listening room conditions.



**Note:**

*This control is effective only for the sound from the front speakers.*

### Adjusting the BASS and TREBLE controls

**BASS**

Turn this clockwise to increase (or counter-clockwise to decrease) the low frequency response.

**TREBLE**

Turn this clockwise to increase (or counter-clockwise to decrease) the high frequency response.

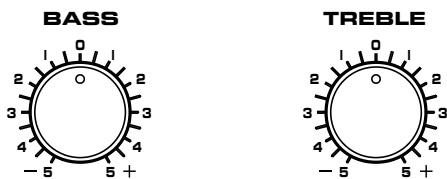

**Note:**

*These controls are effective only for the sound from the front speakers.*

### Using the TONE BYPASS switch

Press this switch to revert instantly to the flat states of the BASS and TREBLE controls without changing the setting of these controls.

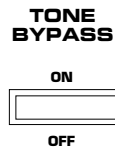

### Using the BASS EXTENSION switch

You can boost bass frequency response by setting this switch to the "ON" position. This switch is effective only on the sound from the front speakers.

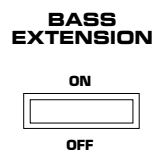

### MUTING Key (Remote Transmitter)

Press this key to mute the master volume. While mute is engaged, an indicator on the master VOLUME control flashes. Press again to un-mute the master volume.

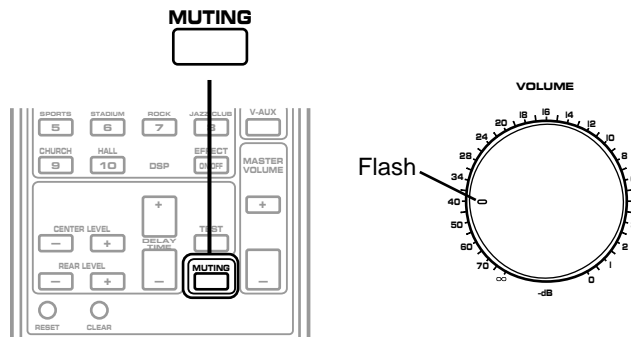

### When you listen with headphones

Connect the headphones to the PHONES jack. You can listen to the sound to be output from the front speakers through headphones.

When listening with headphones privately, set both the SPEAKERS A and B switches to the OFF position and switch off the digital sound field processor (so that no DSP program name is illuminated on the display) by pressing the EFFECT switch.

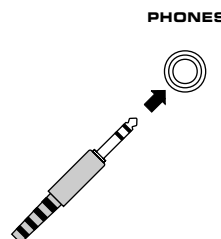

# TUNING OPERATIONS

Normally, if station signals are strong and there is no interference, quick automatic-search tuning (AUTOMATIC TUNING) is possible. However, if signals of the station you want to select are weak, you must tune to it manually (MANUAL TUNING).

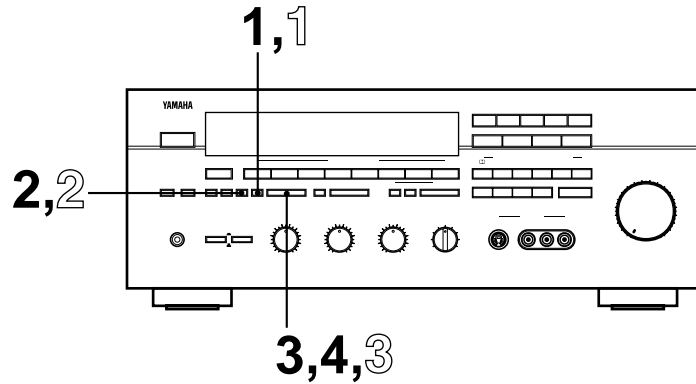

## AUTOMATIC TUNING

- 1 Select the reception band (FM or AM) while watching the display.



- 2

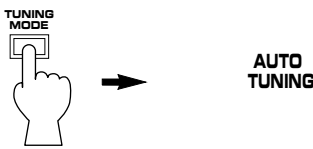

- 3

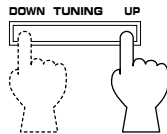

To tune to a higher frequency, press the right side once.  
To tune to a lower frequency, press the left side once.

- 4 If the station where tuning search stops is not the desired one, press again.

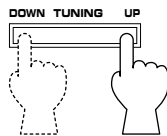

- If the tuning search does not stop at the desired station (because the signals of the station are weak), change to the MANUAL TUNING method.

## MANUAL TUNING

- 1 Select the reception band (FM or AM) while watching the display.



- 2

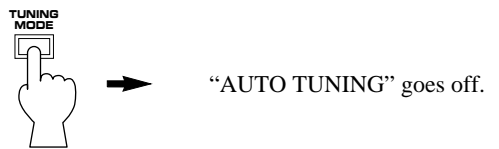

- 3 Tune to a desired station manually.

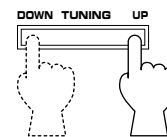

- To continue tuning search, press and hold the button.

### Note:

If you tune to an FM station manually, it is received in monaural mode automatically to increase the signal quality.

## Display information

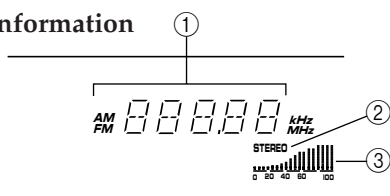

- ① Displays the band and frequency of the received station.
- ② Lights up when an FM stereo broadcast is received in stereo.
- ③ Indicates the signal level of the received station.





## PRESET TUNING

### Manual Preset Tuning

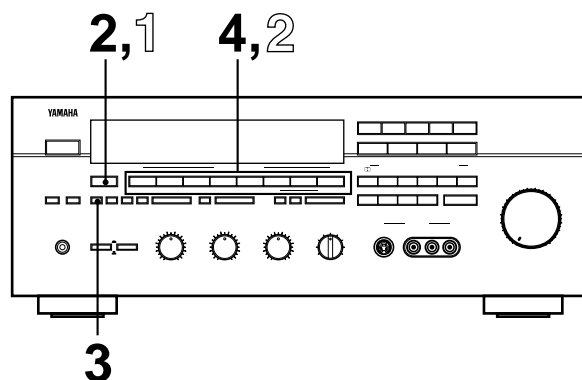
This unit can store station frequencies (selected by tuning operation) by using the preset station buttons. With this function, you can select any desired station by only pressing the corresponding preset station button. Up to 40 stations (8 stations x 5 pages) can be stored.

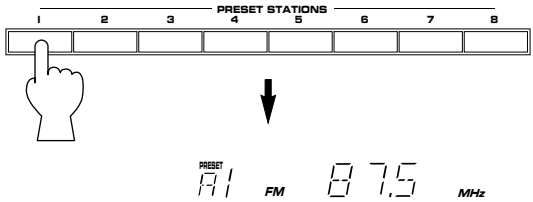

#### To program stations

<b>1</b>	Tune to a desired station. (Refer to the previous page for tuning procedure.)
<b>2</b>	Select a desired page (A - E) of preset station buttons while watching the display. 
<b>3</b>	 Flashes for about 5 seconds.
<b>4</b>	Press a preset station button before the "MEMORY" prompt on the display switches off.  Shows the displayed station has been programmed to A1.

- In the same way, program other stations to A2, A3, to A8.
- You can program more stations to the preset station buttons on other pages in the same way by selecting other pages in step 2.

#### To recall a preset station

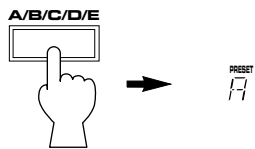
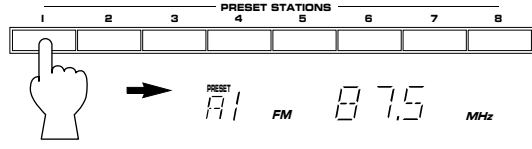
<b>1</b>	Select the page of preset station buttons. 
<b>2</b>	Select the desired preset station button. 

#### Notes:

- A new setting can be programmed in place of the former one.
- For presets, the setting of the reception mode (stereo or monaural) is stored along with the station frequency.

#### Memory back-up

The memory back-up circuit prevents the programmed data from being lost even if the **POWER** switch is set off or the power plug is disconnected from the AC outlet or the power is cut due to temporary power failure. If, however, the power is cut for more than one week, the memory may be erased. If so, it can be re-programmed by simply following the PRESET TUNING steps.

## Automatic Preset Tuning

You can also make use of an automatic preset tuning function for FM stations only. By this function, this unit performs automatic tuning and stores FM stations with strong signals sequentially. Up to 40 stations are stored automatically in the same way as in the manual preset tuning method on page 25.

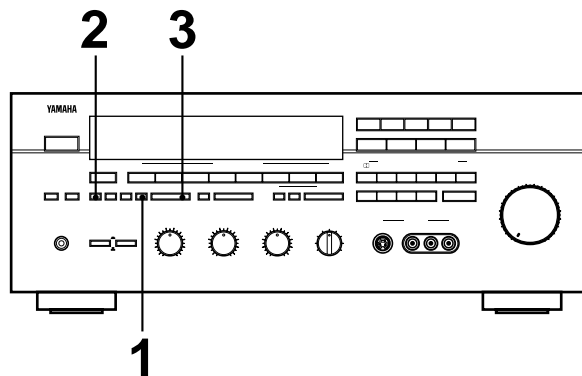

### To program stations

<b>1</b>	<p style="text-align: center;">FM</p>
<b>2</b>	<p style="text-align: center;">Press and hold for about 3 seconds. Flashes</p>
<b>3</b>	<p>To tune to higher frequencies, press right side once. To tune to lower frequencies, press left side once.</p> <ul style="list-style-type: none"> <li>• If the TUNING button is not pressed, in a while the automatic preset tuning begins automatically toward higher frequencies. The automatic preset tuning begins from the frequency currently displayed. Received stations are programmed to A1, A2, to A8 sequentially.</li> <li>• If more than 8 stations are received, they are also programmed to the preset station numbers on other pages (B, C, D and E) in that order.</li> </ul>

**If you want to store the first station received by the automatic preset tuning to a desired preset station number.**

If, for example, you want to store the first received station to C5, select "C5" by using the A/B/C/D/E button and the preset station buttons after pressing the MEMORY button in step 2. Then press the TUNING button. The first received station is stored to C5, and next stations to C6, C7, etc., sequentially. If stations are stored up to E8, the automatic preset tuning is finished automatically.

### When the automatic preset tuning is finished

The display shows the frequency of the last preset station.

Check the contents and the number of preset stations by following the procedure of the section "To recall a preset station" on page 25.

### To recall a preset station

Simply follow the procedure of the section "To recall a preset station" on page 25.

### Notes

- You can replace a preset station by another FM or AM station manually by simply following the procedure of the section "To program stations" on page 25.
- If the number of received stations is not enough to be stored up to E8, the search is finished automatically when it reaches the highest frequency after searching through all frequencies.
- With this function, only FM stations with sufficient signal strength are stored automatically. If the station you want to program is weak in signal strength, tune to it in monaural manually and program it by following the procedure of the section "To program stations" on page 25.

## Exchanging Preset Stations

You can exchange the places of two preset stations with each other as shown below.

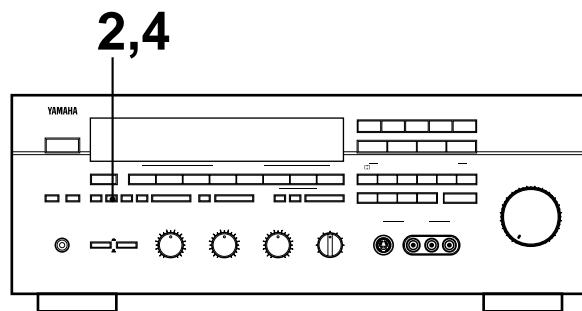

### (Example)

If you want to shift the preset station on E1 to A5, and vice versa.

<b>1</b>	Recall the preset station on E1 (by following the method of "To recall a preset station" on page 25).
<b>2</b>	
<b>3</b>	<p>Next, recall the preset station on A5 by following the procedure in step 1.</p>
<b>4</b>	<p>Shows the exchange of stations is completed.</p>

# USING THE DIGITAL SOUND FIELD PROCESSOR (DSP)

This unit incorporates a sophisticated, multi-program digital sound field processor, which allows you to expand and shape the audio sound field from both the audio and video sources, for a theater-like experience in the listening/viewing room.

This digital sound field processor has 10 programs; 8 programs for digital sound field processing and 2 programs for the Dolby Pro Logic Surround sound system (DOLBY PRO LOGIC and DOLBY PRO LOGIC ENHANCED). You can create an excellent audio sound field by selecting the suitable program and adding desired adjustments. In addition, when the DOLBY PRO LOGIC, DOLBY PRO LOGIC ENHANCED, or 70 mm MOVIE THEATER program is selected, the built-in automatic input balance control functions. This presents you the best surround condition without manual adjustment.

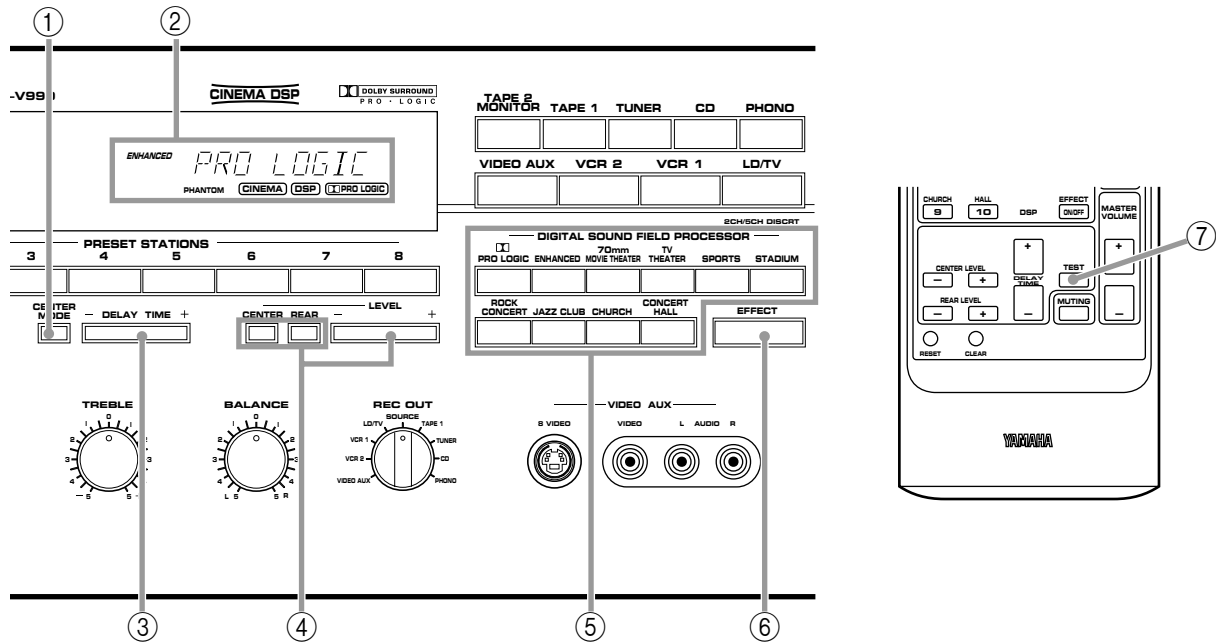

- ① CENTER MODE  
Selects the center channel output mode. (For details, refer to page 19.)
- ② Displays your selection on the DSP or other informations.
- ③ DELAY TIME -/+  
Adjusts the delay time. (For details, refer to page 32.)
- ④ CENTER and LEVEL -/+  
REAR and LEVEL -/+  
Adjusts sound output level at each speaker. (For details, refer to page 31.)
- ⑤ Selects a digital sound field program.
- ⑥ EFFECT  
Switches on/off the digital sound field processor (DSP).
- ⑦ TEST  
Used for speaker balance adjustment. (For details, refer to page 19.)

## Description of Each Sound Field Program

The following list gives brief descriptions of the sound fields produced by each of the DSP programs. Keep in mind that most of these are precise digital recreations of actual acoustic environments. The data for them was recorded at the locations described using sophisticated sound field measurement equipment.

### Note:

**The channel level balance between the left rear effect speaker and the right rear effect speaker may vary depending on the sound field you are listening to. This is due to the fact that most of these sound field recreations are actual acoustic environments.**

PROGRAM	FEATURE
 PRO LOGIC	This program is effective for playback of sources encoded with Dolby Surround. The employment of the digital signal processing system reduces crosstalk and transfers the sound source more smoothly and precisely, compared to conventional types. A stable movie sound field is recreated.
PRO LOGIC ENHANCED	This program is effective for playback of sources encoded with Dolby Surround. Enhancing the "Normal" Dolby Pro Logic, the DSP technology simulates the multi-surround speaker systems of a 35 mm film theater, thus widening the surround-sound field with greater presence.
70 mm MOVIE THEATER	This program is effective for playback of sources encoded with Dolby Surround. The Yamaha DSP technology is ideally combined with the Dolby Pro Logic to present you the incredible listening experience of the 70 mm movie theater. This program is ideal for precisely reproducing the sound design of the newest movies. The sound field is made according to the design of the latest movie theaters, so the reverberations of the sound field itself are restrained as much as possible. The three-dimensional feeling of the sound field is emphasized and dialog is precisely oriented on the screen. You can enjoy watching science-fiction, action, and adventure movies with this program.
TV THEATER	This program is suitable for dramas, variety or music programs, etc. Much surround effect can be gained for stereo sources.
SPORTS	This program is furnished with a tight sound field in which the sound will not spread excessively on the front side, but the rear surround produces a dynamic sound expansion. This program is most suitable for sports programs encoded with Dolby Surround
STADIUM	This program gives you long delays between direct sounds and effect sounds, and the extraordinarily spacious feel of a large stadium.
ROCK CONCERT	This program is suitable for rock music. A big, powerful sound is reproduced lively and dynamically.
JAZZ CLUB	This is a small, cosy jazz club with a low ceiling. The sound is very close and intimate.
CHURCH	This program recreates the acoustic environment of a modern church with a high pointed dome and columns along the sides. This interior produces very few primary reflections.
CONCERT HALL	In this program, the center seems deep behind the front speaker pair, creating an expansive, large hall ambience.

## Description of Dolby Pro Logic Surround

 **DOLBY PRO LOGIC SURROUND:** This unit employs the Dolby Pro Logic Surround system. This system is similar to professional Dolby Stereo decoders used in movie theaters.

By employing a four-channel system, the Dolby Pro Logic Surround system divides the input signals into four levels: the left and right main channels, the center channel (to characterize dialog), and the rear surround-sound channels (to characterize sound effects, background noise and other ambient noise).

Dolby Surround is encoded on the sound track of commercially available video cassettes and video discs as well. When you play a source encoded with

Dolby Surround on your home video system, the Dolby Pro Logic Surround system in this unit decodes the signal and feeds the surround-sound effects. The Dolby Pro Logic Surround mode may not be always effective on video sources not encoded with Dolby Surround.

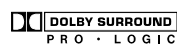

Manufactured under license from Dolby Laboratories Licensing Corporation. "Dolby", the double-D symbol and "Pro Logic" are trademarks of Dolby Laboratories Licensing Corporation.

## To play a source with the digital sound field processor

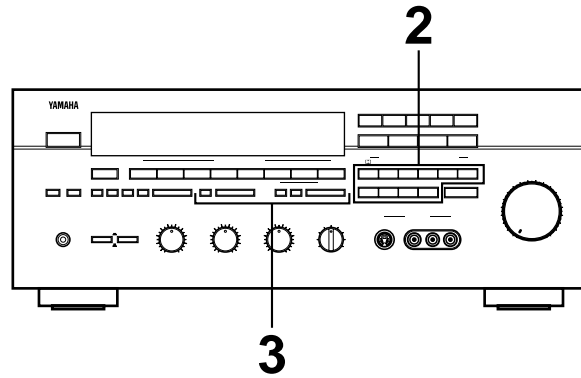

**1** Follow steps 1 - 6 shown in "BASIC OPERATIONS" on page 21.

**2** Select the desired program that is suitable for the source.

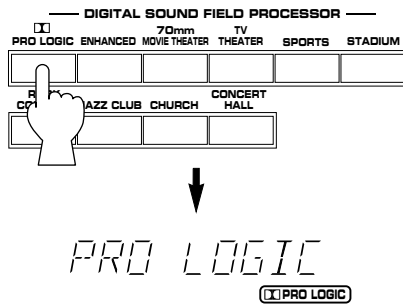

The selected program name is shown on the display.

**3** If desired, adjust the delay time and the output level of each speaker. (For details, refer to the corresponding descriptions on page 31, 32.)

### Notes:

- If you prefer to cancel the DSP, press the EFFECT switch. The sound will be the normal 2-channel stereo without surround sound effect.
- When STADIUM, ROCK CONCERT, JAZZ CLUB, CHURCH, or CONCERT HALL is selected, no sound is heard from the center speaker.
- When a monaural sound source is played with DOLBY PRO LOGIC or DOLBY PRO LOGIC ENHANCED, no sound is heard from the front speakers and the rear speakers. Sound is heard only from the center speaker. However, if the center channel mode is in PHANTOM, the front speakers output the sound of the center channel.
- When this unit's Dolby Pro Logic Surround system is used, if the main-source sound is considerably altered by over adjustment of the BASS or TREBLE controls, the relationship between the center and rear channels may produce an unnatural effect.

## Dolby Surround AC-3

Dolby Surround AC-3 is the next generation of multi-channel consumer audio. It uses a low bit-rate audio encoding scheme, creating a single composite data stream that contains five high-quality full-range channels, plus a sixth low frequency effect channel (called "5.1").

This unit is equipped with 5 CH DISCRT terminals for Dolby Surround AC-3.

### To listen to a 5 CH DISCRT SOURCE:

Press the LD/TV button so that "5 CH DISCRT" appears on the display. To cancel it, press the switch again.

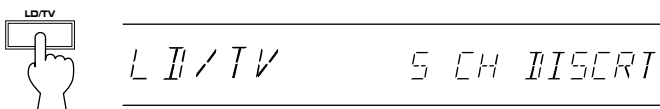

- When you switch to "5 CH DISCRT" mode, the Digital Sound Field processor features of this unit are no longer available. The CENTER MODE switch, DELAY TIME switch and EFFECT switch also no longer work.
- Signals connected to the 5CH DISCRT INPUT are not output to the tape decks or video recorders. To record the signals from an LD player, you must connect the player to the LD/TV terminals.

The following adjustments can be done on the remote control transmitter as well as on the front panel.

## Adjustment of the CENTER LEVEL

You can adjust the sound output level of the center channel speaker even if the output level is already set in "Speaker balance adjustment" on page 18.

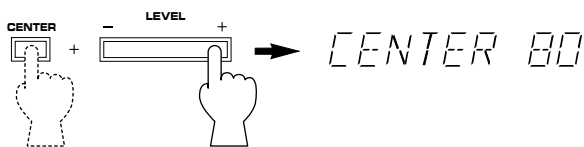

Press the "+" or "-" **CENTER LEVEL** key on the remote control transmitter. As you change the volume level, the front panel LCD will display the value. If you press the "+" or "-" key continuously, the level will continuously change except for a momentary pause at the preset point (80).

- The center channel speaker is used only in DOLBY PRO LOGIC, DOLBY PRO LOGIC ENHANCED, 70 mm MOVIE THEATER, TV THEATER and SPORTS modes.
- Once the output level is adjusted, the level value will be the same in all the digital sound field programs.

### Note:

*If the digital sound field program STADIUM, ROCK CONCERT, JAZZ CLUB, CHURCH, or CONCERT HALL is selected, the CENTER LEVEL control will not function.*

## Adjustment of the REAR LEVEL

You can adjust the sound output level of the rear speakers even if the output level is already set in "Speaker balance adjustment" on page 18.

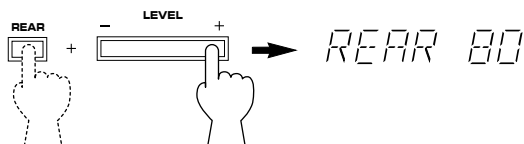

Press the "+" or "-" **REAR LEVEL** key on the remote control transmitter, the level value changes continuously. However, the value stops changing momentarily at the preset point (80).

- Once the output level is adjusted, the level value will be the same in all the digital sound field programs.

## Adjustment of DELAY TIME

You can adjust the time difference between the beginning of the source sound and the beginning of the effect sound with the **DELAY TIME** control.

The **DELAY TIME** control is effective with all programs.

By applying more or less delay, sound effects, background noise, and ambient noise coming at you from the rear speakers can be enhanced or subdued for extra effect.

1.	PRO LOGIC	from 15 to 30 milliseconds (Preset value: 20 milliseconds)
2.	PRO LOGIC ENHANCED	from 15 to 30 milliseconds (Preset value: 20 milliseconds)
3.	70 mm MOVIE THEATER	from 15 to 30 milliseconds (Preset value: 17 milliseconds)
4.	TV THEATER	from 1 to 50 milliseconds (Preset value: 28 milliseconds)
5.	SPORTS	from 1 to 50 milliseconds (Preset value: 20 milliseconds)
6.	STADIUM	from 1 to 50 milliseconds (Preset value: 45 milliseconds)
7.	ROCK CONCERT	from 1 to 50 milliseconds (Preset value: 22 milliseconds)
8.	JAZZ CLUB	from 1 to 50 milliseconds (Preset value: 26 milliseconds)
9.	CHURCH	from 1 to 50 milliseconds (Preset value: 40 milliseconds)
10.	CONCERT HALL	from 1 to 50 milliseconds (Preset value: 30 milliseconds)

By continuously pressing “+” or “-” on the **DELAY TIME** control, the value changes continuously. However, the value stops changing momentarily at the preset point.

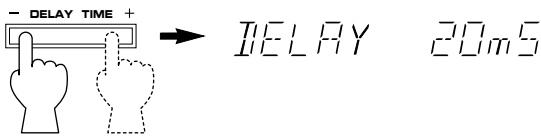

### Note:

*Adding too much delay will cause an unnatural effect with some sources. Experiment with the DELAY TIME control to create the effect that you find most suitable.*

### Note:

*The values of the DELAY TIME, CENTER LEVEL and REAR LEVEL you set the last time will remain memorized even when the power of this unit is off.*

*However, if the power cord is kept disconnected for more than one week, these values will be automatically changed back to the original factory settings.*



# SETTING THE SLEEP TIMER

If you use the SLEEP timer of this unit, you can make this unit turn off automatically. When you are going to sleep while enjoying a broadcast or other desired input source, this timer function is helpful.

**Notes:**

- The SLEEP timer can be controlled only with the remote control transmitter.
- The components on which the SLEEP timer is effective are the sources connected to the SWITCHED AC OUTLET(S) on the rear panel of this unit.

**To set the SLEEP time**

**1**

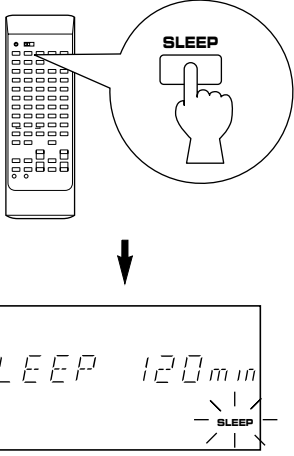

Flashes continuously.

Whenever the SLEEP key is pressed, the SLEEP time will change as follows:

(Minutes)

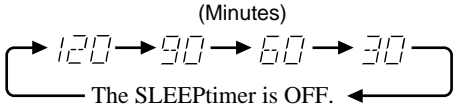

The SLEEptimer is OFF.  
(The indication before the SLEEP key is pressed.)

After a while, the display returns to the indication before the SLEEP timer is set, and the "SLEEP" indicator stops flashing and lights up.

**2** The unit will be turned off automatically at the selected SLEEP time.

**To cancel the selected SLEEP time**

**1**

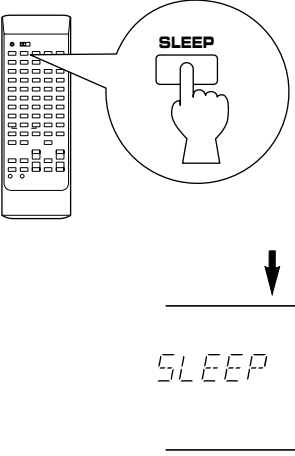

Press the SLEEP key until "SLEEP OFF" appears on the display.

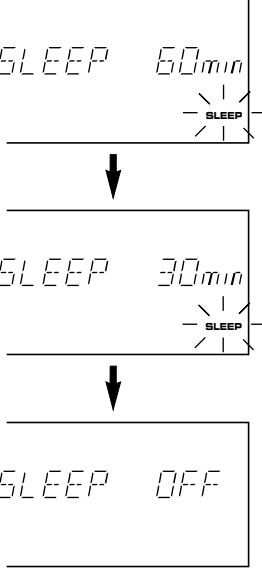

Press once or more so that the display returns to the indication before the SLEEP timer is set. ("SLEEP" will go off from the display.)

**Note:**

The SLEEP timer setting can also be canceled by turning off the power with the POWER switch or disconnecting the power plug of this unit from the AC outlet.

# REMOTE CONTROL TRANSMITTER

## Battery installation

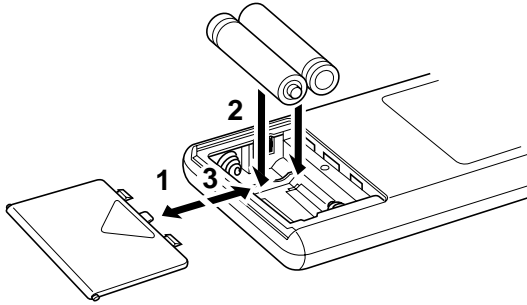

## Battery replacement

If you find that the remote control transmitter must be used closer to the main unit, the batteries are weak. Replace both batteries with new ones.

### Notes:

- Use only AA, LR6, UM-3 batteries for replacement.
- Be sure the polarities are correct. (See the illustration inside the battery compartment.)
- Remove the batteries if the remote control transmitter will not be used for an extended period of time.
- If batteries leak, dispose of them immediately. Avoid touching the leaked material or letting it come in contact with clothing, etc. Clean the battery compartment thoroughly before installing new batteries.

## Remote control transmitter operation range

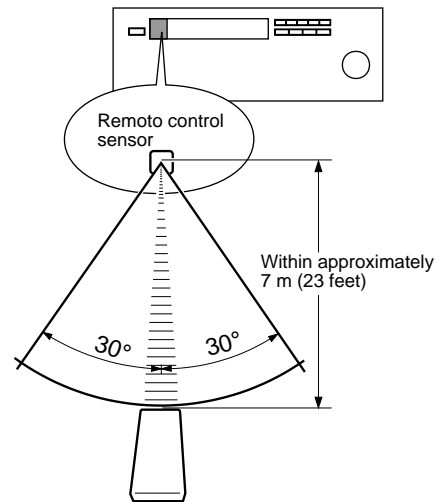

### Notes:

- There should be no large obstacles between the remote control transmitter and the main unit.
- If the remote control sensor is directly illuminated by strong lighting (especially an inverter type of fluorescent lamp etc.), it might cause the remote control transmitter not to work correctly. In this case, reposition the main unit to avoid direct lighting.

The remote control transmitter provided with this unit is designed to control all the most commonly used functions of the unit. If the CD player, tape deck, etc. connected to this unit are YAMAHA components designed for remote control compatibility, then this remote control transmitter will also control various functions of each component.

- When you operate this unit and/or other YAMAHA components with this remote control transmitter, set the YPC-USER-LEARN switch to the YPC (Yamaha Preset Code) position.

### For Control of This Unit

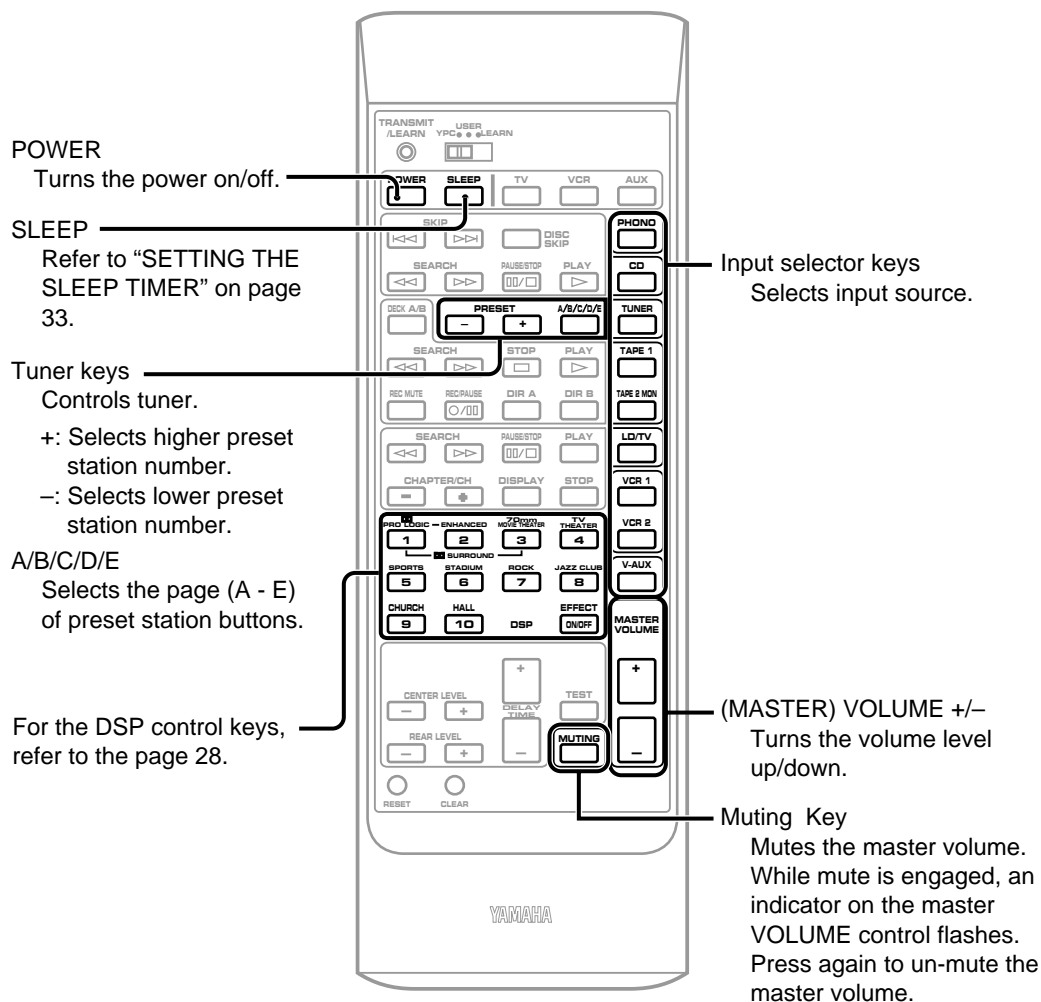

## For Other Component Control

Identify the remote control transmitter keys with your component's keys. If these keys are identical, their functions will be the same. On each key function, refer to the corresponding instruction on your component's manual.

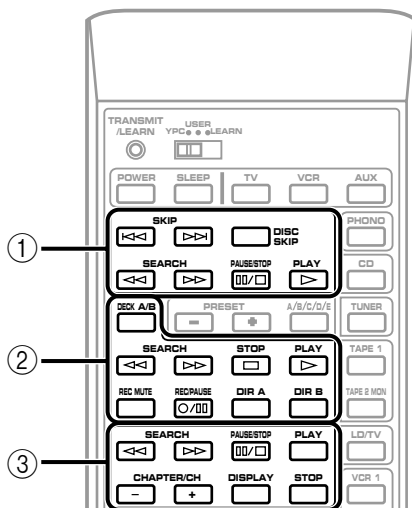

### ① CD player keys

Controls compact disc player.

DISC SKIP is applicable only to compact disc changer.

### ② Tape deck keys

Controls tape deck.

DIR A, B and DECK A/B are applicable only to double cassette tape deck.

For a single cassette deck with automatic reverse function, pressing DIR A will reverse the direction of tape running.

### ③ LD player keys

Controls LD player.

# REMOTE CONTROL “LEARNING” FUNCTION



All of the keys on this remote control transmitter can be programmed to “learn” key-functions from other remote control transmitters without losing the preset key functions. By using this feature, this unit can then be used in place of one or more other remote control transmitters, thus making operation of your various audio and video components more convenient. Use the included user program sheets to indicate a new function learned for each key.

**Note:**

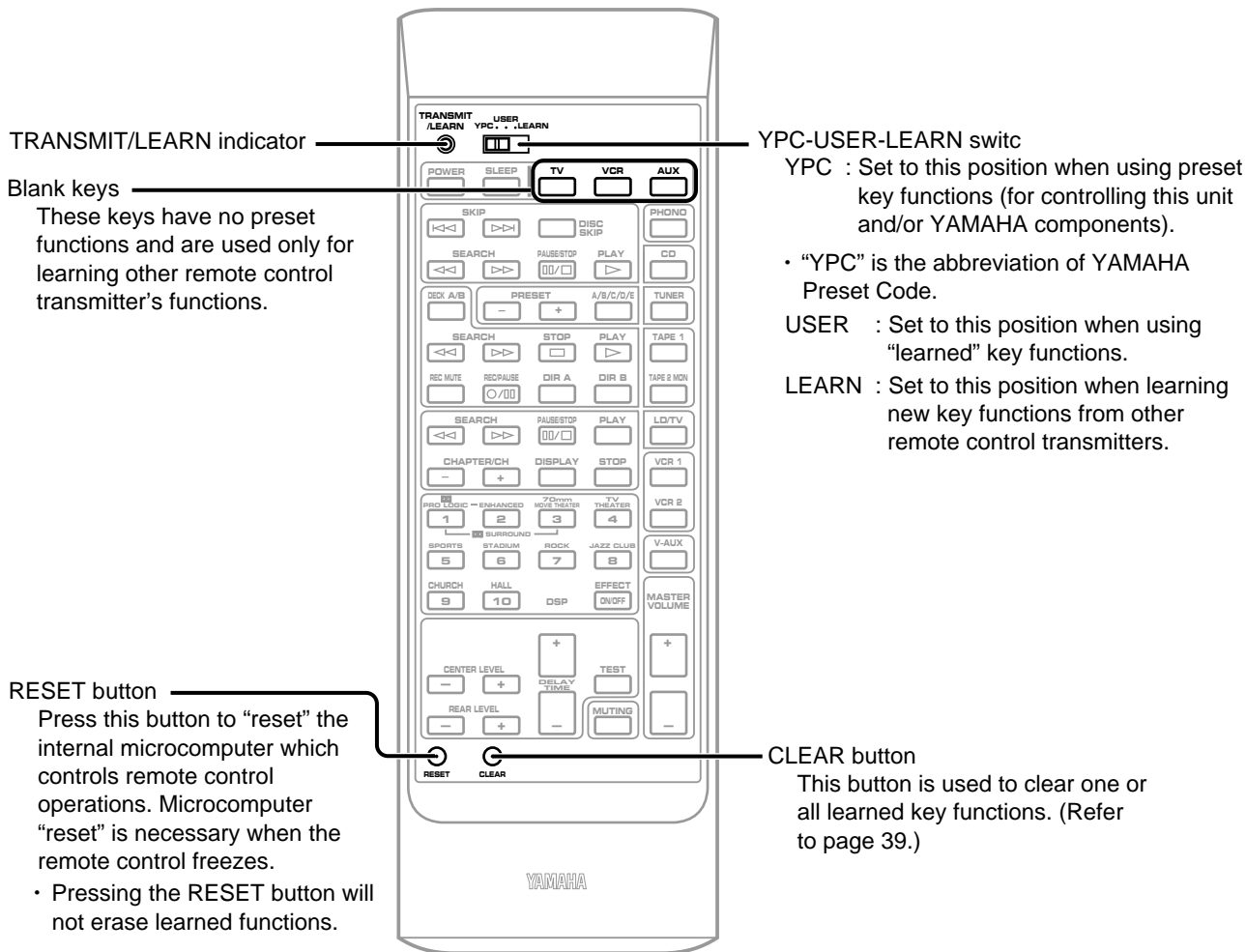
There may occasionally be instances in which, due to the signal-coding and modulation employed by the other remote control transmitter, this unit will not be able to “learn” its signals.

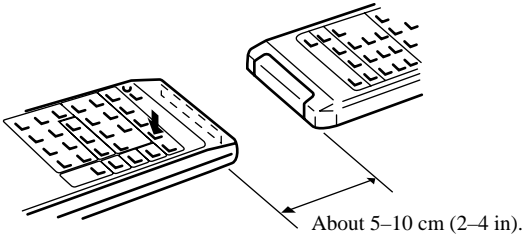
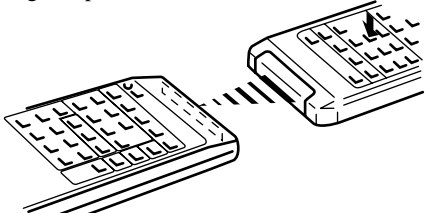

## To learn a new function

<p><b>1</b> Set to the “LEARN” position.</p> 
<p><b>2</b> Press a key on this unit where a new function will be learned.</p> 
<p><b>3</b> Press and hold the key (on the other remote control transmitter) where the desired new function is. Lights up</p> 
<p><b>4</b> Repeat step 2 and 3 until all desired functions are successfully learned.</p>
<p><b>5</b> Set to the “USER” position.</p>  <p>Try operating your components.</p>

### Notes:

- When you operate the desired component with this remote control transmitter, TRANSMIT/LEARN indicator will flash steadily.
- The originally preset function of a key is still available in the USER position if a new function has not been learned to the key.
- Successful learning to a key results in the erasure of previously learned functions and their replacement by the newly learned ones.
- If there is no more room in the memory area for a function to be learned, the TRANSMIT/LEARN indicator will flash on and off. In this case, even if some keys are not occupied with functions from other remote control transmitters, no further learning is possible.

### Memory back-up

All of the learned functions will be retained while you replace the batteries. However, if no batteries are installed for a few hours, the learned functions will be erased and will have to be learned again.

## To clear a learned function

- 1** Set to the "USER" position.

- 2** Press and hold the CLEAR button using the point of a mechanical pencil, etc.

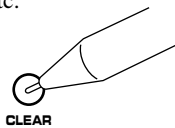
- 3** Press and hold the key where the learned function to be deleted is until the indicator flashes 3 times.

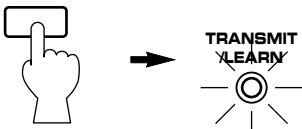

  - To clear two or more functions, repeat step 2 and 3.

**Note:**

*If a key is not pressed soon after the CLEAR button is pressed, this unit will automatically return to the status that was in effect before the CLEAR button was pressed.*

## To clear all learned functions

- 1** Set to the "LEARN" position.

- 2** Press and hold the CLEAR button using the point of a mechanical pencil, etc.

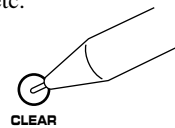
- 3** Press and hold any key until the indicator flashes 7 times

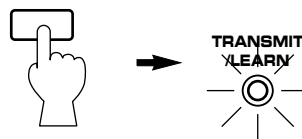

## Troubleshooting guide

SYMPTOM	CAUSE	REMEDY
The remote control transmitter does not work.	The batteries of this remote control transmitter are weak.	Replace the batteries with new ones and press the RESET button on the remote control transmitter.
Learning cannot be made successfully. (The TRANSMIT/LEARN indicator does not light up or flash.)	The internal microcomputer "freezes".	Replace the batteries (and press the RESET button for this remote control transmitter).
	The batteries of this remote control transmitter and/or the other remote control transmitter are weak.	Place the remote control transmitters with the proper distance.
	The distance between the two remote control transmitters is too long or too short.	Learning is not possible.
	The signal coding or modulation of the other remote control transmitter is not compatible with this remote control transmitter.	Further learning is not possible without deleting unnecessary commands.
	Memory capacity is full.	Press the RESET button on the remote control transmitter.

# TROUBLESHOOTING

If the unit fails to operate normally, check the following points to determine whether the fault can be corrected by the simple measures suggested. If it cannot be corrected, or if the fault is not listed in the SYMPTOM column, disconnect the power cord and contact your authorized YAMAHA dealer or service center for help.

	SYMPTOM	CAUSE	REMEDY
Amplifier	The unit fails to turn on when the POWER switch is pressed.	Power cord is not plugged in or is not completely inserted.	Firmly plug in the power cord.
	No sound or no picture.	Incorrect output cord connections.	Connect the cords properly. If the problem persists, the cords may be defective.
		Appropriate input selector is not pressed.	Press the appropriate input selector corresponding to the input source.
	The sound suddenly goes off.	The protection circuit has been activated because of short circuit etc.	Turning the unit off and then on will reset the protection circuit.
		The SLEEP timer functioned.	Do not make the SLEEP timer function.
	Only one side speaker outputs the sound	Incorrect setting of the BALANCE control.	Adjust it to the appropriate position.
		Incorrect cord connections.	Connect the cords properly. If the problem persists, the cords may be defective.
	Sound "hums".	Incorrect cord connections.	Firmly connect the audio plugs. If the problem persists, the cords may be defective.
		No connection from the turntable to the GND terminal.	Make the GND connection between the turntable and this unit.
	The volume level is low while playing a record.	The record is being played on a turntable with an MC cartridge.	The player should be connected to the unit through the MC head amplifier.
	The volume level cannot be increased, or sound is distorted.	The power to the component connected to the REC OUT terminals of this unit is off.	Turn the power to the component on.
	No sound from the rear speakers.	The sound output level to the rear speakers is set to 0.	Turn up the sound output level with the REAR LEVEL control.
		The monaural sound source is played in DOLBY PRO LOGIC or DOLBY PRO LOGIC ENHANCED mode.	Select another program suitable for the monaural sound source.
	No sound from the center speaker.	The sound output level to the center speaker is set to 0.	Turn up the sound output level with the CENTER LEVEL control.
The center channel mode is in PHANTOM mode.		Select NORMAL or WIDE.	
Incorrect sound field program selection.		Select the appropriate program.	
No sound field program is selected.			
FM	FM stereo reception is noisy.	Because of the characteristics of FM stereo broadcasts, this is limited to cases where the transmitter is too far away or the antenna input is poor.	Check the antenna connections. Try using a multiple element FM antenna.
	There is distortion and clear reception cannot be obtained even with a good FM antenna.	There is multipath interference.	Adjust antenna placement to eliminate multipath interference.
	A desired station cannot be tuned in with Auto tuning.	The station is too weak.	Use Manual tuning mode. Use a high quality directional FM antenna.
AM	A desired station cannot be tuned in with Auto tuning.	Weak signal or loose antenna connections.	Tighten the AM loop antenna connections and rotate it for best reception. Use Manual tuning mode.
	There are continuous crackling and hissing noises.	Noises will result from lighting, fluorescent lamps, motors, thermostats and other electrical equipment.	Use an outdoor antenna and a ground wire. This will help somewhat but it is difficult to eliminate all noise.
	There are buzzing and whining noises (especially in the evening).	A television set is being used nearby.	Relocate this unit away from the TV.
Remote control transmitter	The remote control transmitter does not work.	Direct sunlight or lighting (of an inverter type of fluorescent lamp etc.) is striking the remote control sensor of the main unit.	Change the position of the main unit.
		The batteries of this remote control transmitter are too weak.	Replace the batteries with new ones.
others	The sound is degraded when monitoring is performed by using the headphones connected to the compact disc player or cassette deck which are connected with this unit.	The power to this unit is off.	Turn the power to this unit on.



# SPECIFICATIONS

## AUDIO SECTION

Minimum RMS Output Power per Channel

Front L, R

8 ohms, 20 Hz to 20 kHz, 0.015% THD ..... 100W+100W

6 ohms, 20 Hz to 20 kHz, 0.04% THD [U.S.A. model only] ..... 120W+120W

Center

8 ohms, 1 kHz, 0.015% THD ..... 100W

Rear L, R

8 ohms, 1 kHz, 0.08% THD ..... 25W+25W

Dynamic Power per Channel (by IHF Dynamic Headroom measuring method)

8/6/4/2 ohms ..... 130/160/215/310W

Dynamic Headroom [U.S.A. and Canadian models only]

8 ohms ..... 1.14 dB

Power Band Width

8 ohms, 50W, 0.08% THD ..... 10 Hz to 50 kHz

Damping Factor (SPEAKER-A)

8 ohms, 20 Hz to 20 kHz ..... 200 or more

Input Sensitivity/Impedance

PHONO MM ..... 2.5 mV/47 k-ohms

5ch DISCRT/CD/TAPE/LD-TV/VCR ..... 150 mV/47 k-ohms

MAIN IN ..... 1.0V/47 k-ohms

Maximum Input Signal

PHONO MM (1 kHz, 0.02% THD) ..... 110 mV or more

CD/TAPE/LD-TV/VCR (EFFECT ON) (1 kHz 0.5% THD) ..... 2.2V

Output Level/Impedance

REC OUT ..... 150 mV/1.0 k-ohms

PRE OUT (FRONT) ..... 1.0V/1.5 k-ohms

LPF (EFFECT OFF) ..... 3.5V/2.7 k-ohms

Headphone Jack Rated Output/Impedance (8 ohms, 1 kHz, 150 mV) ..... 0.55V/390 ohms

Frequency Response (20 Hz to 20 kHz)

MAIN IN ..... 0±0.2 dB

CD/TAPE/LD-TV/VCR (FRONT L/R) ..... 0±0.5 dB

RIAA Equalization Deviation

PHONO MM ..... 0±0.5 dB

Total Harmonic Distortion

PHONO MM to REC OUT

20 Hz to 20 kHz, 1V ..... 0.01% or less

CD/TAPE/LD-TV/VCR (EFFECT OFF) to SPOUT

20 Hz to 20 kHz, 50W/8 ohms ..... 0.015% or less

CD/TAPE/LD-TV/VCR to SPOUT (REAR)

1 kHz 12.5W/8 ohms ..... 0.3% or less

Signal-to-Noise Ratio (IHF-A Network)

PHONO MM to REC OUT (5 mV Input Shorted) ..... 86 dB or more

CD/TAPE/LD-TV/VCR to SP OUT (Input Shorted, EFFECT OFF) ..... 98 dB or more

Residual Noise (IHF-A Network)

SP OUT (FRONT L/R) ..... 170 µV or less

Channel Separation (Vol. -30 dB, EFFECT OFF)

PHONO MM (Input Shorted 1 kHz/10 kHz) ..... 60 dB or more/55 dB or more

CD/TAPE/LD-TV/VCR (Input 5.1 k-ohms Shorted 1 kHz/10 kHz) ..... 60 dB or more/45 dB or more

Tone Control Characteristics

BASS: Boost/cut ..... ±10 dB (50 Hz)

Turnover Frequency ..... (350 Hz)

TREBLE: Boost/cut ..... ±10 dB (20 kHz)

Turnover Frequency ..... (3.5 kHz)

Filter Characteristics

LPF (fc=200 Hz) ..... 6 dB/oct

Gain Tracking Error (0 to -70 dB) ..... 3 dB or less

Tuner Output Level/Impedance (1 kHz)

FM 100% MOD ..... 500 mV/2.2 k-ohms

AM 30% MOD ..... 150 mV/2.2 k-ohms

BASS EXTENSION ..... +6dB (50 Hz)

## VIDEO SECTION

Video Signal Type [U.S, Canadian models] ..... NTSC

Video Signal Level ..... 1 Vp-p/75 ohms

S-Video Signal Level

Y ..... 1 Vp.p/75 ohms

C ..... 0.286 Vp.p/75 ohms

Maximum Input Level ..... 1.5 Vp-p or more

Signal-to-Noise Ratio ..... 50 dB or more

Monitor Out Frequency Response ..... 5 Hz to 10 MHz, -3 dB

## FM TUNER SECTION

Tuning Range [U.S.A. and Canadian models] ..... 87.5 to 107.9 MHz

50 dB Quieting Sensitivity (IHF, 75 ohms)

Mono ..... 1.55 µV (15.1 dBf)

Stereo ..... 21 µV (37.7 dBf)

Usable Sensitivity (75 ohms) (30 dB S/N Quieting, 1 kHz, 100% mod.) ..... 0.8 µV (9.3 dBf)

Image Response Ratio ..... 45 dB

IF Response Ratio ..... 80 dB

Spurious Response Ratio ..... 70 dB

AM Suppression Ratio ..... 55 dB

Capture Ratio ..... 1.5 dB

Alternate Channel Selectivity ..... 85 dB

Signal-to-Noise Ratio (IHF)

Mono/Stereo ..... 80 dB/75 dB

Harmonic Distortion (1 kHz)

Mono/Stereo ..... 0.1/0.2%

Stereo Separation (1 kHz) ..... 50 dB

Frequency Response

20 Hz to 15 kHz ..... 0 ±1.5 dB

## AM TUNER SECTION

Tuning Range [U.S.A., Canadian models] ..... 530 to 1,710 kHz

Usable Sensitivity ..... 100 µV/m

Selectivity ..... 32 dB

Signal-to-Noise Ratio ..... 50 dB

Image Response Ratio ..... 40 dB

Spurious Response Ratio ..... 50 dB

Harmonic Distortion (400 Hz) ..... 0.3%

## GENERAL

Power Supply [U.S.A. and Canadian models] ..... AC 120V, 60 Hz

Power Consumption [U.S.A.] ..... 340W

[Canadian models] ..... 330W/440VA

AC Outlets [U.S.A model]

2 SWITCHED OUTLETS ..... 120W max. total

1 UNSWITCHED OUTLET ..... 200W max.

[Canadian model]

2 SWITCHED OUTLETS ..... 120W max. total

1 UNSWITCHED OUTLET ..... 180W max.

Dimensions (W x H x D) ..... 435 x 171 x 470 mm (17-1/8" x 5-3/4" x 15-3/16")

Weight ..... 15.0 kg

Accessories ..... AM loop antenna

Indoor FM antenna

Adapter for F-type connector

Remote control transmitter

Batteries

User Program Sheets

Specifications are subject to change without notice.

# YAMAHA

---

YAMAHA ELECTRONICS CORPORATION, USA 6660 ORANGETHORPE AVE., BUENA PARK, CALIF. 90620, U.S.A.  
YAMAHA CANADA MUSIC LTD. 135 MILNER AVE., SCARBOROUGH, ONTARIO M1S 3R1, CANADA  
YAMAHA ELECTRONIK EUROPA G.m.b.H. SIEMENSSTR. 22-34, 25462 RELINGEN BEI HAMBURG, F.R. OF GERMANY  
YAMAHA ELECTRONIQUE FRANCE S.A. RUE AMBROISE CROIZAT BP70 CROISSY-BEAUBOURG 77321 MARNE-LA VALLEE-CEDEX 2, FRANCE  
YAMAHA ELECTRONICS (UK) LTD. YAMAHA HOUSE, 200 RICKMANSWORTH ROAD WATFORD, HERTS WD1 7JS, ENGLAND  
YAMAHA SCANDINAVIA A.B J A WETTERGRENS GATA 1, BOX 30053, 400 43 VÄSTRA FRÖLUNDA, SWEDEN  
YAMAHA MUSIC AUSTRALIA PTY, LTD. 17-33 MARKET ST., SOUTH MELBOURNE, 3205 VIC., AUSTRALIA

YAMAHA CORPORATION

VU82160-1 BWWb.V Printed in Japan