

YAMAHA KX-W302/U *RS*

Natural Sound Stereo, Double Cassette Deck

Platine à double cassette de la série "Natural Sound"

"Natural Sound" Stereo-Doppelkassettendeck

"Natural Sound" Stereokassettdäck

Registratore a doppia cassette Stereo a suono naturale

Magnetófono estéreo de dos casetes de sonido natural

CENTER

OWNER'S MANUAL
MODE D'EMPLOI
BEDIENUNGSANLEITUNG
BRUKSANVISNING
MANUALE DELL'UTENTE
MANUAL DE INSTRUCCIONES

FRONT PANEL
PANNEAU AVANT
FRONTPLATTE

FRAMSIDA
PANNELLO ANTERIORE
PANEL DELANTERO

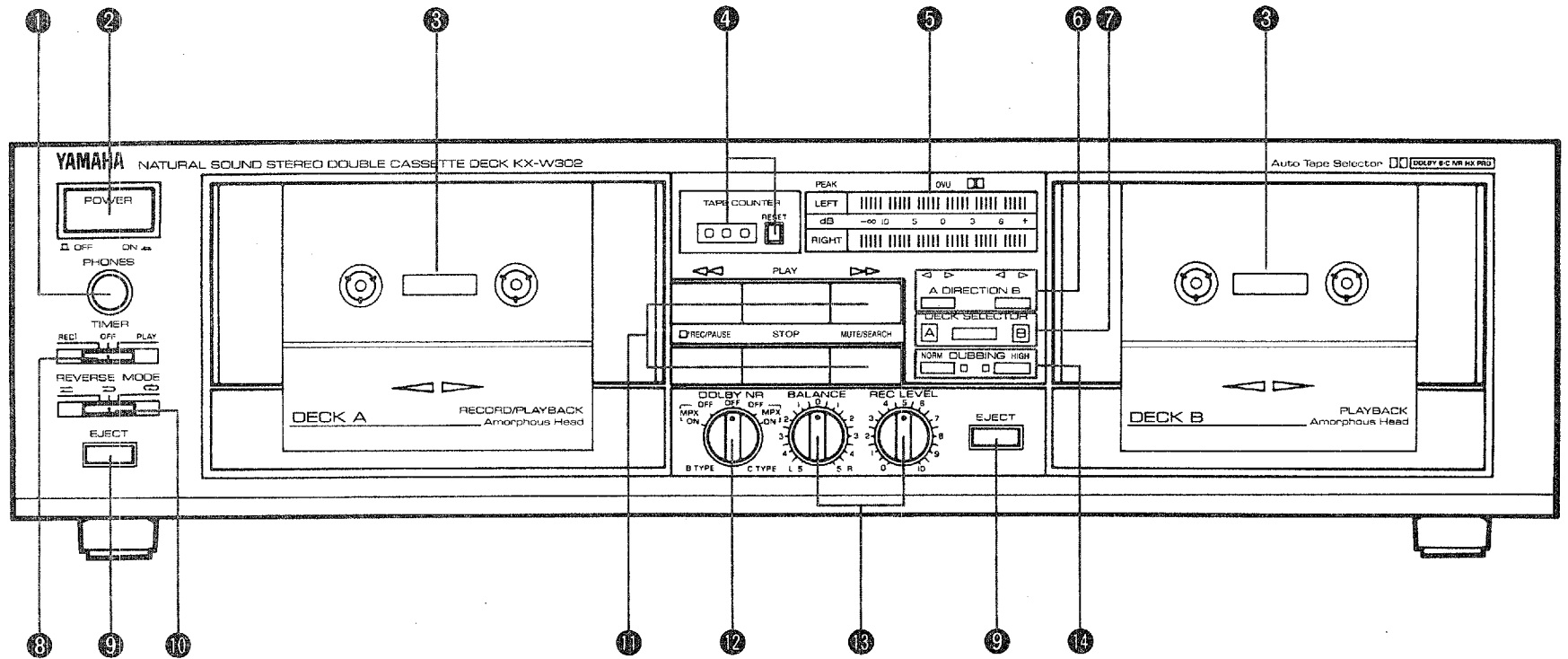

2 REAR PANEL AND CONNECTIONS
PANNEAU ARRIERE ET CONNEXIONS
RÜCKPLATTE UND ANSCHLÜSSE
BAKSIDA OCH ANSLUTNINGAR
PANNELLO POSTERIORE E COLLEGAMENTI
PANEL TRASERO Y CONEXIONES

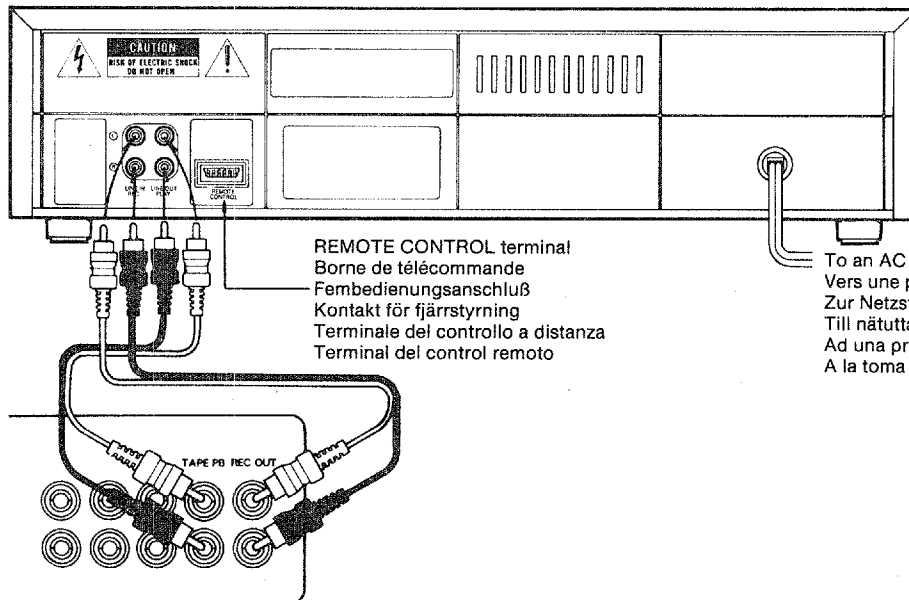

REMOTE CONTROL terminal
 Borne de télécommande
 Fernbedienungsanschluß
 Kontakt för fjärrstyrning
 Terminale del controllo a distanza
 Terminal del control remoto

To an AC outlet
 Vers une prise CA
 Zur Netzsteckdose
 Till nätuttag
 Ad una presa di c.a.
 A la toma de CA

Amplifier or receiver
 Amplificateur ou ampli-syntoniseur
 Verstärker oder Receiver
 Förstärkare eller receiver
 Amplificatore o sintoamplificatore
 Amplificador o receptor

3 DETECTOR SLOTS
TROUS DE DETECTION
ERKENNUNGSÖFFNUNGEN

AVKÄNNINGSHÅL
FESSURE DI IDENTIFICAZIONE
RANURAS DE DETECCIÓN

TYPE II

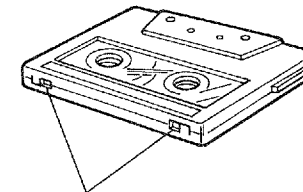

detector slots
 trous de détection
 Erkennungsöffnungen
 Avkänningshål
 Fessure di identificazione
 ranuras de detección

TYPE IV

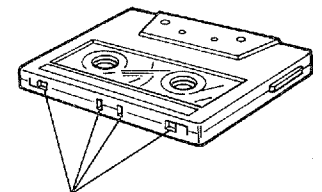

detector slots
 trous de détection
 Erkennungsöffnungen
 Avkänningshål
 Fessure di identificazione
 ranuras de detección

4 RECORDING PROTECTION
PROTECTION CONTRE L'ENREGISTREMENT
AUFNAHMESCHUTZ
INSPELNINGSSKYDD
PROTEZIONE DELLA REGISTRAZIONE
PROTECCIÓN DE GRABACIÓN

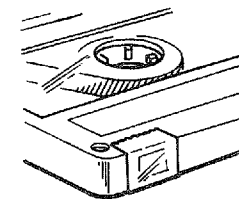
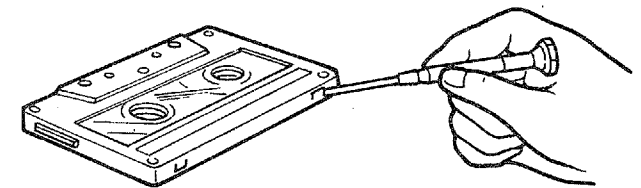

5 **TAPE SLACK**
RELACHEMENT DE LA BANDE
LOSES BAND
BANDSLINGA
NASTRO ALLENTATO
FLOJEDAD DE CINTA

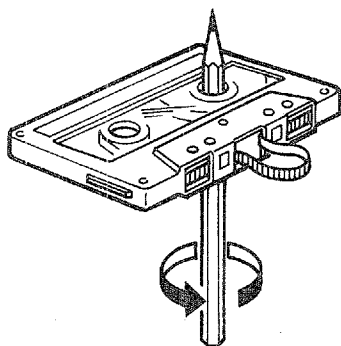

6 **TIMER CONNECTION**
CONNEXION DE LA MINUTERIE
SCHALTUHR-ANSCHLUSS
TIMERANSLUTNING
COLLEGAMENTO DEL TIMER
CONEXIÓN DE UN TEMPORIZADOR

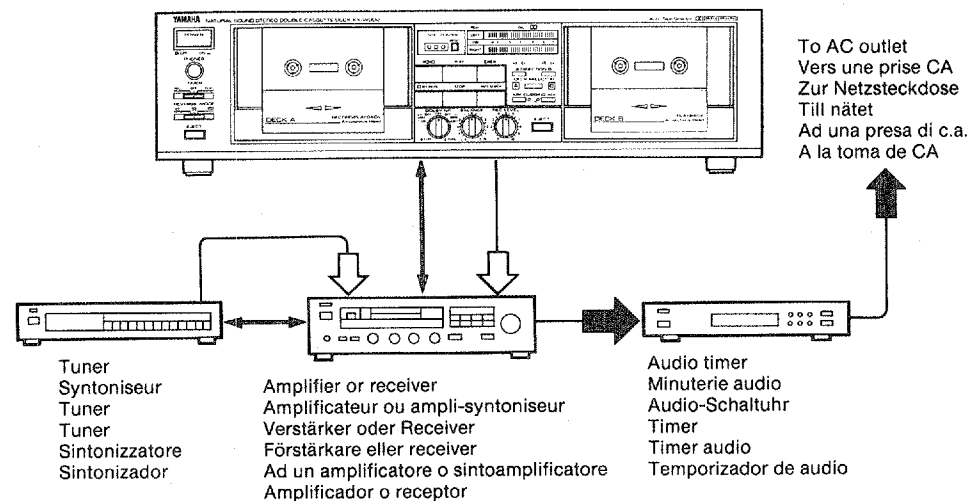

● Thank you for purchasing the YAMAHA KX-W302/U stereo cassette deck.

CAUTION: READ THIS BEFORE OPERATING YOUR UNIT.

- 1.** This unit is a sophisticated stereo cassette deck. To ensure proper operation for the best possible performance, please read this manual carefully.
- 2.** Choose the installation of your unit carefully. Avoid placing it in direct sunlight or close to source of heat. Also avoid locations subject to vibration and excessive dust, heat, cold or moisture. Keep it away from such sources of hum as transformers or motors.
- 3.** Do not open the cabinet as this may result in damage to the deck or electrical shock. If a foreign object should get into the deck, contact your local dealer.
- 4.** When removing the power plug from the wall outlet, always pull directly on the plug; never pull the cord itself.
- 5.** Do not use force when operating switches and knobs.
- 6.** When moving the deck, be sure to first pull out the power plug and remove all cords connecting the deck to other equipment.
- 7.** Do not attempt to clean this unit with chemical solvents as this may damage the finish. Use a clean, dry cloth.

- 8.** Never allow metallic items (e.g. screwdrivers, tools, etc.) to come near the record/playback head assembly. Doing so may not only scratch or damage the head's mirror-smooth finish, it may change the magnetic characteristics of the heads, causing a deterioration in reproduction performance quality.
- 9.** Although the record/playback head used in this unit is a high quality Amorphous head with outstanding reproduction characteristics, it can become dirty through the use of old tapes or from dust accumulation over time. This can have a serious effect on reproduction quality. Clean the heads regularly with one of the commonly available head cleaners or with cleaning solutions as explained later in this manual.
- 10.** Be sure to read the "Troubleshooting" section of this manual for advice on common operating errors before concluding that your unit is faulty.
- 11.** Keep this manual in a safe place for future reference.
- 12.** Voltage Selector (General Model only)
The voltage selector on the rear panel of this unit must be set for your local mains voltage BEFORE plugging in the AC mains supply.
Voltages are 110/120/220/240V AC, 50/60 Hz.

WARNING

TO PREVENT FIRE OR SHOCK HAZARD, DO NOT EXPOSE THIS APPLIANCE TO RAIN OR MOISTURE.

SPECIAL INSTRUCTIONS FOR U.K. MODEL

IMPORTANT:

The wires in the mains lead are coloured in accordance with the following code.

Blue: NEUTRAL
Brown: LIVE

As the colours of the wires in the mains lead of this apparatus may not correspond with the coloured markings identifying the terminals in your plug, proceed as follows. The wire which is coloured BLUE must be connected to the terminal which is marked with the letter N or coloured BLACK. The wire which is coloured BROWN must be connected to the terminal which is marked with the letter L or coloured RED.

CAUTION (FOR CANADA MODEL):

TO PREVENT ELECTRIC SHOCK DO NOT USE THIS (POLARIZED) PLUG WITH AN EXTENSION CORD, RECEPTACLE OR OTHER OUTLET UNLESS THE BLADES CAN BE FULLY INSERTED TO PREVENT BLADE EXPOSURE.

FRONT PANEL PARTS AND FUNCTION

(See Fig. 1.)

① PHONES jack

Connect a set of headphones to this jack for monitoring recording or playback.

② POWER switch

Press this switch to turn the power on. Press again to turn the power off.

③ Cassette compartments

To load a cassette tape, press the EJECT button and the cassette compartment will open. Insert a cassette with the exposed tape side facing down. To close the compartment, push in the compartment door until it locks shut.

④ TAPE COUNTER and RESET button

Use the TAPE COUNTER as an aid in locating a point on a tape. Press the RESET button to set the TAPE COUNTER to "000".

- The TAPE COUNTER works for DECK A only.

⑤ PEAK level meters

Indicate the peak of the signal level during recording and playback over a range from $-\infty$ dB to +6 dB.

⑥ DIRECTION buttons and indicators

Press the DIRECTION A button to select the tape running direction of DECK A. Press the DIRECTION B button to select the tape running direction of DECK B. The corresponding indicator above the button will light. When the tape is running from left to right, the ► indicator is lit (forward side), and when the tape is running from right to left, the ◀ indicator is lit (reverse side).

To fast forward a tape, press either the ◀◀ or ▶▶ button, the one pointing in the same direction as the DIRECTION indicator. To fast rewind a tape, press either the ◀◀ or ▶▶ button, the one pointing in the opposite direction as the DIRECTION indicator.

⑦ DECK SELECTOR and indicators

Press this button to select the deck to be operated either DECK A or DECK B. When A indicator located at the left of the button is lit, the operation buttons function for DECK A. When B indicator located at the right of the button is lit, the operation buttons function for DECK B.

⑧ TIMER switch

With a commercially available audio timer, set this switch to REC for unattended recording, and to PLAY to timer playback. When the timer is not used, be sure to set this switch to OFF.



⑨ EJECT buttons

To load a cassette tape, press the EJECT button and the cassette compartment will open. Depress the cassette compartment to close it.

- * Be careful not to press the EJECT button while the tape is moving.

REVERSE MODE selector

The tape running pattern will be changed according to the setting of this selector. Set the selector by referring to the table below.

Status	Mode	Playback	Recording or Dubbing	Fast-winding
		One side of the tape is played back, and the tape stops at its end.	One side of the tape is recorded, and the tape stops at its end.	After completion of a fast-winding operation, the tape stops.
		After the forward side (▶) of a tape is played back, the reverse side (◀) is played back. The tape stops at its end. When playback starts from the reverse side (◀), playback does not change to the forward side (▶), however the tape stops at the end of the reverse side of a tape.	After the forward side (▶) of a tape is recorded, the reverse side (◀) is recorded. The tape stops at its end. When recording or dubbing starts from the reverse side (◀), the tape stops at the end of its reverse side.	After completion of a fast-winding (▶▶) operation, the reverse side (◀) is played back. After completion of a fast-winding ◀◀ operation, the tape stops at its end.
		Both sides of a tape are repeatedly played back up to 8 times.		After completion of a fast-winding ▶▶ operation, the reverse side ◀ is played back and both sides of the tape are repeatedly played back. After completion of a fast-winding ◀◀ operation, the forward side ▶ is played back and both sides of the tape are repeatedly played back.

Notes on quick auto-reverse function

- This unit uses a light sensor to detect the tape leader for quick auto-reverse. Occasionally, tapes have colored leaders — this may cause the quick auto-reverse to malfunction. In this case, the tape will reverse after it reaches the end. Also, sunlight or artificial light shining directly on the front of the deck may cause the quick auto-reverse to malfunction.
- Quick reverse does not function if recording or playback is activated with less than 10 seconds of tape remaining.

Operation buttons

First, select the deck to be operated, with the DECK SELECTOR, then operate the following buttons.

Fast-wind ◀◀ and ▶▶: Press to fast-wind a tape.

To fast-forward a tape, press either the fast-wind ◀◀ or ▶▶ button, the c pointing in the same direction as the DIRECTION indicator. To fast-rewind the tape, press either the fast-wind ◀◀ or ▶▶ button, the one pointing in the opposite direction of the DIRECTION indicator.

PLAY: Press for playback. It is also necessary to use this button to engage Record mode.

REC/PAUSE and indicator: This button functions only for DECK A. Pressing this button sets the DECK A to Rec Standby mode, and the indicator light up. While in this mode the PEAK level meters will function allowing you to monitor the recording signal level of your program source. (Refer to the "SETTING RECORDING LEVEL" section of this manual.) To initiate recording from the Rec Standby mode, press the PLAY button. Pressing the REC/PAUSE button during actual recording engages the Rec Pause mode. To resume recording, press the PLAY button.

STOP: Press this button to stop the tape while in any mode.

MUTE/SEARCH:

• During Recording:

When the MUTE/SEARCH button is pressed at any time during recording, a second blank interval is automatically recorded onto the tape (Auto Rec Mute mode), then the Rec/Pause mode is engaged immediately thereafter.

In order to record a blank interval longer than 4 seconds, press the MUTE/SEARCH button and hold it down for the desired length of time.

After the button is released, the additional 4-second blank interval will also be recorded, then the Rec/Pause mode is engaged immediately thereafter.

* When the MUTE function is operating, the REC/PAUSE indicator lights on and off.

• During play or stop mode:

Pressing either the fast-wind ◀◀ or ▶▶ button simultaneously with the MUTE/SEARCH button searches for the beginning of the next, current, or previous selection from the one which you are listening to or stopped at. See "SELECTION SEARCH" section of this manual.

⑫ DOLBY NR selector

OFF:

Set to this position if no noise reduction is desired.

In the OFF position, signals do not pass through the noise reduction circuits and are output unprocessed.

B and C TYPE:

Dolby noise reduction is an extremely effective method of reducing undesirable background hiss on tapes. This unit incorporates both Dolby B NR and the newer Dolby C NR systems. Dolby C NR is approximately twice as effective as Dolby B NR. When making recordings (of sources except FM. If FM, see MPX ON and OFF) to be encoded with Dolby NR, set the selector to the desired type of Dolby noise reduction; B or C TYPE MPX OFF.

When playing back any tape (even a recording of an FM broadcast) encoded with Dolby B or Dolby C, set the selector to the B TYPE MPX OFF or C TYPE MPX OFF, respectively.

- Dolby and the double D symbol are trademarks of Dolby Laboratories Licensing Corp. Dolby noise reduction system manufactured under license from Dolby Laboratories Licensing Corp.

MPX filter ON and OFF:

When recording from FM stations, set the selector to the Dolby NR desired and also set it to the B or C TYPE MPX ON position. However, when not recording FM broadcasts but using Dolby NR, set the selector to the B or C TYPE MPX OFF position.

- FM stations transmit a 19 kHz pilot signal in addition to the broadcast program. Sometimes this pilot signal may leak into the audio output depending on the tuner and broadcast conditions. Since the 19 kHz pilot signal is undesirable, activating the MPX filter will effectively filter out the signal.

⑬ REC LEVEL and BALANCE controls (DECK A only)

REC LEVEL: This control is used to adjust and set the recording level.

Turning it clockwise increases the recording level, and turning it counterclockwise decreases the recording level.

BALANCE: This control is used to balance the recording levels of the left and right channels. Turning it clockwise decreases the left channel's recording level. While turning the control counterclockwise decreases the right channel's recording level. Normally, adjust this control so that left and right recording level indicators peak to the same reading.

⑭ DUBBING buttons and indicators

Press this button to dub the tape from DECK B to DECK A. For high speed dubbing, press the HIGH button. For high quality dubbing, press the NORM button. The corresponding indicator lights up.

CONNECTIONS

■ REAR PANEL CONNECTORS (See Fig. 2.)

Make sure that power to both the deck and your amplifier/receiver are turned off before making any connection.

The White plug on the paired connecting cables corresponds to the Left channel and the Red plug corresponds to the Right channel. The LINE OUT/PLAY jacks on the deck should be connected to the Tape PB (Playback/Input) jacks on your amplifier/receiver, and the LINE IN/REC jacks on the deck should be connected to the Rec Out (Rec/Output) jacks on your amplifier/receiver. Make sure that the left and right channel connections are properly made, and that the plugs are inserted firmly.

Connect the power cord to an AC wall outlet or to an AC outlet on the rear panel of your amplifier/receiver (if provided).

With the REMOTE CONTROL terminal on the rear of the deck, system remote control through the YAMAHA amplifier/receiver with *RS* mark is possible.

Connect the terminal to the amplifier/receiver with the flat cable supplied to the amplifier/receiver. For details of operation, refer to the Owner's Manual of the amplifier/receiver.

CASSETTE TAPES

■ CASSETTE TAPES

There are many different types of cassette tapes available, however, they all conform to standard specifications so any brand may be used with the deck.

* YAMAHA does not recommend the use of 120 minutes length cassette since the extreme thinness of the tape makes them susceptible to mechanical and recording problems.

● Classification of Cassettes Tapes by Formulation

Cassette tapes are available in four basic types depending on their formulation or type of magnetic material and manufacturing process. These four types are commonly known as Normal (Type/NORM), Chrome (Type II/CrO₂), Ferrichrome (Type III/FeCr), and Metal (Type IV/METAL), and they each require specific tape deck adjustments for optimum performance.

■ AUTO TAPE SELECTOR DETECTION SLOTS (See Fig. 3.)

The deck has a built-in Auto Tape Selector which automatically adjusts for the proper bias, level and equalization according to the tape formulation — all you have to do is load a cassette and the Auto Tape Selector does the rest.

The Auto Tape Selector determines what type of tape is loaded by sensing detector slots in the top of a tape shell. Each tape formulation has its own characteristic hole markings which has been standardized by the tape industry.

- Early model Metal (Type IV/Metal) tape formulation cassette shells do not have the slots for Auto Tape Selector operation. As a result, early model Metal type tapes recorded on another deck will be played back with the deck at the Chrome (Type II/CrO₂) settings. YAMAHA does not recommend recording with this kind of tape on the deck.
- The deck does not have the required setting for Ferrichrome (Type III/FeCr) tape, since this tape formulation is not widely used. Should you use a Ferrichrome tape, it will be recorded and played back at the Normal (Type NORM) settings. And this will result in an unnatural high frequency emphasis.

FEATURES

■ PROTECTING YOUR RECORDINGS (See Fig. 4.)

All cassette tapes are provided with erasure protection holes to prevent accidental erasure of recorded contents. There is a small tab covering the hole on each cassette, and it should be broken off after recording a tape. Without this tab covering the hole, it is impossible to record onto that tape. Thus, you can safely protect a recording for as long as you wish without fear of accidental erasure. Should you wish to use a cassette tape protected in this way for recording, simply covering the hole with adhesive tape will permit erasure and re-recording.

* When using Chrome (Type II/CrO₂) or Metal (Type IV/METAL) tapes, make sure you do not cover the hole intended for the Auto Tape Selector operation.

■ TAKING UP SLACK IN THE TAPE (See Fig. 5.)

As a precaution against tape entanglement and damage, before inserting cassettes into the deck, remove any slack in the tape. This is accomplished by inserting a pencil, pen or similar object into one of the spools and gently winding it until all the slack is removed. You do not have to wind it too tightly. Be careful not to touch the tape part itself. It is very delicate and touching it may damage the tape and its recorded contents.

■ STORING CASSETTES

After putting a cassette tape back into its case, store in a location away from exposure to direct sunlight, humidity, high temperatures, and magnetic fields (away from television sets, speakers, etc.). High temperatures and humidity will damage the tape itself, while exposure to magnetic fields may cause a loss of recorded material. Avoid touching the tape surface with your fingers, since dirt or finger oil will contaminate the deck's heads.

■ DOLBY NOISE REDUCTION

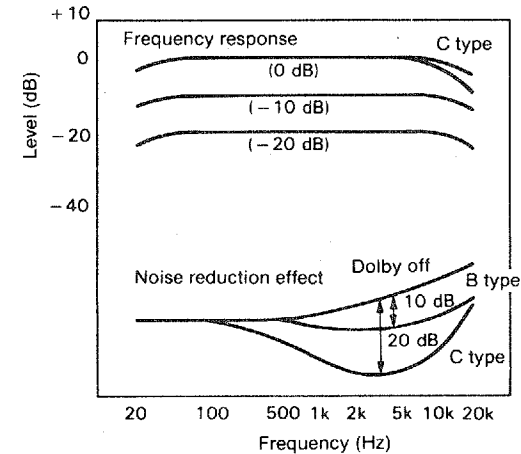

With cassette tapes, the most noticeable form of noise is high frequency hiss. To reduce this hiss noise, the unit is equipped with the newer Dolby C noise reduction system in addition to the older Dolby B NR. Either type of noise reduction may be selected with the DOLBY NR selector.

The older Dolby B system is still very handy when playing back that extensive library of Dolby B encoded tapes as well as recording tapes that will be played back on a system which offers only this kind of noise reduction system (some car, portable, and older cassette decks).

Dolby B NR has a noise reduction effect of about 10 dB in the high frequency range. The corresponding effect with Dolby C NR is about 20 dB, but this is over the entire range where the human ear is most sensitive to noise (2 kHz to 8 kHz). Dolby C NR also improves the tape's MOL (Maximum Output Level).

Dolby C NR has two new circuits: a spectral skewing circuit and an anti-saturation network. By improving the saturation level of the tape, it is possible to prevent high frequency loss, encode/decode error, etc., and improve dynamic range, signal-to-noise ratio, and make it easier to set the recording level. Also, by expanding the operating frequency range to two octaves more than that of Dolby B NR, overall noise balance is obtained and the system also becomes effective against high frequencies from the power supply transformer. The graph shows the frequency response and the noise reduction effect of recording and playback with Dolby B NR, and Dolby C NR. The noise reduction effect of Dolby C NR is larger — approximately 20 dB.

Dolby noise reduction is a 2 part process that acts both on recording and playback; be sure that the DOLBY NR selector is set to the same position during record and play.

- * Tapes encoded with Dolby NR should be decoded with their respective systems. Nevertheless, a Dolby encoded tape can be played back without decoding (and vice versa) with no harm to the recording.
- * Noise in the source material cannot be reduced with the Dolby NR system.

■ HX PRO DYNAMIC BIAS SERVO SYSTEM

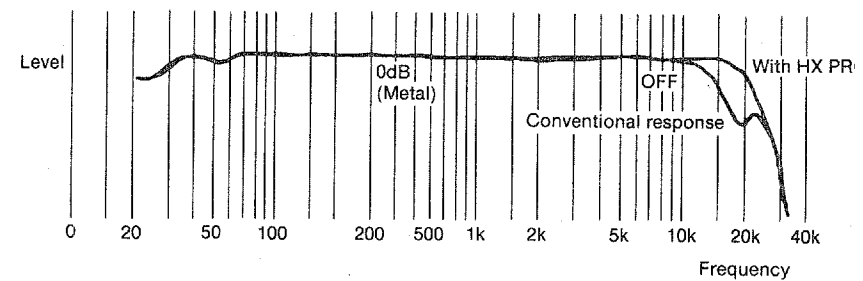

When recording, a bias current according to the tape type used is applied to the recording head as well as the music signal to improve the distortion rate. Furthermore, the extreme high frequency content of a music signal can actually act as bias, adding to the deck's own bias signal to produce over-bi conditions. The result is the deterioration of the high frequency components the music signal.

To remedy this, the Dolby HX PRO system monitors the total amount of effective bias during recording, and instantaneously compensates for any excess bias by reducing the deck's bias signal level accordingly. The deck operates independently on each channel.

Since HX PRO is not a noise reduction system because it functions only in recording and no decoding is required, a tape recorded with the HX PRO system can be played back on any other cassette deck while retaining the benefits of HX PRO.

Dolby Noise reduction and HX PRO headroom extension are manufactured under license from Dolby Laboratories Licensing Corporation. HX PRO originally developed by Bang & Olufsen.

"DOLBY", the double-D symbol  and "HX PRO" are trademarks of Dolby Laboratories Licensing Corporation.

RECORDING AND PLAYBACK

RECORDING (DECK A only)

1. Make sure that the TIMER switch is set to the OFF position, then turn on the POWER switch.
 2. Press the DECK SELECTOR so that A indicator lights up.
 3. Open the cassette compartment by pressing the EJECT button and load a cassette tape in DECK A with the exposed tape face down.
 4. Set the REVERSE MODE selector and DIRECTION button as desired.
 5. Select the noise reduction system with DOLBY NR selector.
 6. Press the REC/PAUSE button to engage the Rec Standby mode.
 7. Play the program source to be recorded, and adjust the recording level using the REC LEVEL control.
 8. Press the PLAY button to start recording.
 9. To temporarily stop the recording, press the REC/PAUSE button. To resume recording, press the PLAY button again.
 10. To stop recording, press the STOP button.
- * When MUTE/SEARCH button is pressed during recording, a 4-second blank interval is automatically recorded on the tape, then the Rec Pause mode is engaged.
 - When the ► side is recorded, pressing the fast-wind ◀◀ button rewinds the tape to the point at which recording has been started. When the ◀ side is recorded, pressing the fast-wind ►► button rewinds the tape to the point at which recording has been started. (Rec Return function)

■ SETTING RECORDING LEVEL

Proper setting of the recording level is crucial in making a quality recording. If the recording level is set too high, the recording will sound distorted and muffled. If the recording level is set too low, the full recording capabilities of the tape will not be reached and the recording will sound faint and too quiet. The key in making a good recording is, therefore, to adjust the recording level as high as possible while still avoiding distortion. Press the REC/PAUSE button to engage the Rec/Standby mode, and play a section of the program to be recorded. Watch the PEAK Level meters and adjust the REC LEVEL control so that the average meter reading is between -5 dB and +3 dB, with occasional peaks no higher than +6 dB.

■ DUBBING (DECK B to DECK A)

Since the DECK A is dual purpose, recording and playback, while DECK B is for playback only, this unit permits dubbing from DECK B to DECK A.

1. Make sure that the TIMER switch is set to the OFF position, then turn on the POWER switch.
 2. Open the cassette compartments by pressing the EJECT buttons and load a recorded cassette tape in DECK B and blank cassette tape in DECK A.
 3. Set the REVERSE MODE selector and DIRECTION button as desired.
 4. Press the NORMAL or HIGH DUBBING button according to the desired dubbing speed. Dubbing starts automatically.
 5. To stop dubbing, press STOP button.
- When DECK A finishes recording, DECK A and DECK B stops at the same time.

When DECK B finishes playing, DECK B stops and DECK A stops after providing a blank section of about 4 seconds.

- * During dubbing, the tape cannot be encoded with Dolby NR, regardless of the setting of the DOLBY NR selector. (When the tape to be dubbed is recorded with Dolby NR, the Dolby NR effect is also dubbed.)

NOTE:

Please check the laws on copyright in your country to record from records, discs, tapes, radio, etc. Recording the prerecorded tapes or other published or broadcast material may infringe copyright laws.

PLAYBACK

1. Make sure that the TIMER switch is set to the OFF position, then turn on the POWER switch.
2. Open the cassette compartment by pressing the EJECT button and load a recorded cassette tape.
3. Select the deck to be operated, with DECK SELECTOR.
4. Set the REVERSE MODE selector and DIRECTION button as desired.
5. For tapes recorded with Dolby NR system, set the DOLBY NR selector.
 - To play back a tape encoded with Dolby B NR or Dolby C NR, set the DOLBY NR selector to the B TYPE MPX OFF or C TYPE MPX OFF position, respectively.
6. Press the PLAY button to start playback.
7. To stop playback, press the STOP button.
 - The TAPE COUNTER works for DECK A only.

SELECTION SEARCH

To search for the beginning of next selection which you are listening to or stopped at....

When the DIRECTION indicator ► is lit, press the ►► button simultaneously with the MUTE/SEARCH button.

When the DIRECTION indicator ◀ is lit, press the ◀◀ button simultaneously with the MUTE/SEARCH button.

The tape will be rapidly wound to the beginning of the next selection and start play.

To search for the beginning of the current selection which you are listening to or stopped at....

When the DIRECTION indicator ► is lit, press the ◀◀ button simultaneously with the MUTE/SEARCH button.



When the DIRECTION indicator ◀ is lit, press the ►► button simultaneously with the MUTE/SEARCH button.

The tape will be rapidly wound to the beginning of the current selection and begin play.

If the selection previous to the current one is desired, press the same buttons again. The tape will be rapidly wound to the beginning of the previous selection and begin play.

RELAY PLAY

1. Make sure that the TIMER switch is set to the OFF position, then turn on the POWER switch.
2. Open the cassette compartments by pressing the EJECT buttons and load cassette tape to be played first in DECK A and a cassette to be played next in DECK B.
3. Press the DECK SELECTOR so that A indicator lights up.
4. Set the REVERSE MODE selector by referring to the table below. The tape running patterns are different according to the REVERSE MODE selector setting.
 - * The ► or ◀ shows the tape running direction.

	DECK A (► or ◀) → DECK B (► or ◀) * In this case, select the desired tape running direction for tapes loaded in both DECK A and DECK B.
	DECK A (► → ◀) → DECK B (► → ◀)
	DECK A (► → ◀) → DECK B (► → ◀) * The tape will be repeatedly played back up to 8 times this way.

5. Press the PLAY button to start relay play. When cassette loaded in DECK A reaches its end, DECK A automatically stops and DECK B starts playing.
6. To stop relay play, press the STOP button.
 - * For tapes recorded with Dolby NR system, set the DOLBY NR selector.

TIMER RECORDING/PLAYBACK (See Fig. 6.)

When using the TIMER switch in combination with a commercially available audio timer, it is possible to make recordings and initiate playback at any time automatically by presetting the deck in advance.

Timer Recording (DECK A only)

1. Make sure that all power cord connections between the timer and amplifier are properly made. No change in any of the other connections between deck and amplifier, etc., is necessary.
2. After turning on the power to each component, select the station on your tuner which you want to record and turn down the volume on your amplifier. This will have no effect on the recording signal level. Remember to set the proper recording level.
3. Set the timer to the desired times. It is advisable to set the timer to begin recording slightly before the actual recording time, and end slightly after the actual recording time, so that you leave some room for later editing.
4. Set the TIMER switch to the REC position.
5. The timer will send power to the amplifier, tuner and deck at the preset time, turning all the components on and initiating the recording mode.

CAUTION:

If the tape cannot be ejected after timer recording, set the TIMER switch to OFF and the deck's POWER switch to ON; the tape can then be ejected.

Timer Playback

1. All connections are the same as for timer recording.
 2. Turn on the amplifier and adjust the volume and Tone controls.
 3. Set the input mode selector of your amplifier to the Tape mode.
 4. Set the timer to the time you wish to start and stop playback.
 5. Set the TIMER switch to the PLAY position.
 6. At the preset time, the timer will turn power on to the amplifier and tape deck and begin playback. It will shut power OFF, at the preset time as well ending playback.
- * When cassettes are loaded in both DECK A and DECK B, the unit enters the relay play mode and DECK A starts playback first.
When a cassette is loaded in DECK A or DECK B, the DECK having a cassette starts playback.

■ CLEANING OF TAPE PATH

The continued high quality performance of your deck is dependent upon regular periodic cleaning of the heads, capstan, pinch roller, and all surfaces over which the tape travels. Normal use will see an accumulation of dirt and dust on the heads, capstans, and pinch rollers. This can lead to poor sound quality, drop outs (intervals with no sound), unsteady tape speed, loss of high frequency response, etc.

We recommend commercially available cassette and fluid type cleaners.

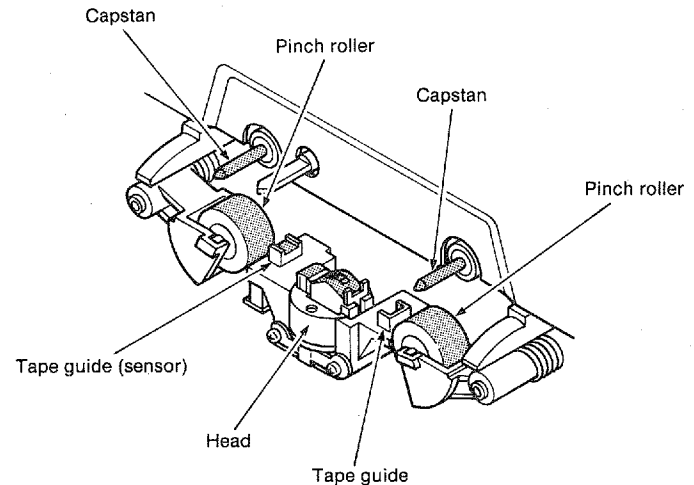

* Clean the parts.

SPECIFICATIONS

■ DEMAGNETIZATION

After 20-30 hours of use, enough residual magnetism will have built up on the heads to cause poor high frequency reproduction. At this time you should use a commercially available head demagnetizer.

- When demagnetizing the heads, be sure to follow the instructions of the head demagnetizer carefully.

■ CLEANING THE CABINET

Clean the cabinet with a soft cloth lightly moistened with a mild detergent. Never use solvents such as benzine, acetone, alcohol, etc. for they may damage the deck's finish.

Track Configuration 4 track, 2 channel recording & playback stereo cassette tape deck
Motor DC servo motor
Heads	
Rec/play head Amorphous
Erase head Double Gap Ferrite
Wow and Flutter	
W.RMS No more than 0.05%
W.Peak No more than $\pm 0.1\%$
Fast Winding Time About 100 seconds (C-120)
Signal-to-Noise Ratio	
(Dolby off) More than 58 dB
(Dolby B on) More than 66 dB
(Dolby C on) More than 74 dB
Frequency Response (-20 dB)	
Normal Tape 20 — 16,000 Hz, ± 3 dB
CrO₂ Tape 20 — 18,000 Hz, ± 3 dB
Metal Tape 20 — 20,000 Hz, ± 3 dB
Harmonic Distortion No more than 1.0%
Channel Separation More than 40 dB
Crosstalk More than 55 dB
Input Sensitivity/Impedance	
Line 50 mV/50 k-ohm
Output Reference level/Load impedance	
Line 360 mV/1.5 k-ohm
Phones 0.3 mW/8 ohm
Power Requirements	
Canada model AC 120V, 60 Hz
Europe model AC 220V, 50 Hz
U.K. and Australia models AC 240V, 50 Hz
General model AC 110/120/220/240V, 50/60 Hz
Power Consumption 18 W
Dimensions (W x H x D) 435 x 112 x 271.5 mm (17-1/8" x 4-3/8" x 10-11/16")
Weight 4.7 kg (10 lbs. 6 oz.)

Specifications subject to change without notice.

TROUBLESHOOTING

When your cassette deck fails to function properly, before assuming it is faulty, check it according to the following troubleshooting list. It details the corrective action you can take yourself without having to call a service engineer. If you have any doubts or questions, get in touch with your nearest Yamaha dealer.

Symptom	Cause	Remedy
Tape doesn't move in recording or playback.	<ul style="list-style-type: none"> ● Power plug not properly plugged in. ● DECK SELECTOR not properly set. 	<ul style="list-style-type: none"> ● Reinsert plug properly. ● Set the DECK SELECTOR correctly.
REC/PAUSE button fails to function.	<ul style="list-style-type: none"> ● No cassette tape loaded. ● Protective tab broken off. 	<ul style="list-style-type: none"> ● Load a cassette tape. ● Change to different tape, or cover the hole remaining after removal of tab with adhesive tape.
Sounds become faint and sometimes inaudible.	<ul style="list-style-type: none"> ● Heads are dirty. ● Heads are magnetized. ● Worn out or poor quality tape. 	<ul style="list-style-type: none"> ● Clean head using cleaning tape. ● Demagnetize head using head demagnetizer. ● Change to different tape.
Playback sound are poorly balance.	<ul style="list-style-type: none"> ● DOLBY NR selector not properly set. 	<ul style="list-style-type: none"> ● Playback in the position in which was recorded.
Recorded sounds are distorted.	<ul style="list-style-type: none"> ● Recording level is too high. 	<ul style="list-style-type: none"> ● Check input level with meter and use lower recording level when recording.
Excessive noise.	<ul style="list-style-type: none"> ● Heads are dirty. ● Heads are magnetized. ● Worn out or poor quality tape. ● Connection(s) improperly made. ● Affected by external electrical noise. 	<ul style="list-style-type: none"> ● Clean head. ● Demagnetize head with head demagnetizer. ● Change to better tape. ● Check input and output connections and reinsert properly. ● Move away from electrical appliances (TV, light, electric blanket, etc.)
Excessive wow (Wavering of the sound).	<ul style="list-style-type: none"> ● Dirty capstan, pinch roller, etc. or poor tape. ● Tape is unevenly wound. 	<ul style="list-style-type: none"> ● Clean capstan, pinch roller, or change to better tape. ● Rewind tape.
Fails to record.	<ul style="list-style-type: none"> ● REC LEVEL control too low. ● Protective tabs broken off. 	<ul style="list-style-type: none"> ● Adjust REC LEVEL control. ● Change tape or cover protective hole with adhesive tape.
Mute Search does not operate.	<ul style="list-style-type: none"> ● Recorded section is too short. ● Recorded section has low-level portions. ● Conversation, etc. has been recorded. 	<ul style="list-style-type: none"> ● Blank sections must be at least 4 seconds long.

● *Nous vous remercions d'avoir acheté la platine à cassette stéréo KX-W302/U YAMAHA.*

ATTENTION: LIRE CECI AVANT DE FAIRE FONCTIONNER VOTRE APPAREIL.

1. Cet appareil est une platine à cassette stéréo sophistiquée. Pour en garantir un bon fonctionnement et d'excellentes performances, lire ce manuel avec attention.

2. Choisir avec soin l'endroit où vous installerez votre appareil. Eviter de le placer exposé directement au soleil ou près d'une source de chaleur. Eviter aussi les endroits sujets aux vibrations, à la poussière, la chaleur, le froid ou à l'humidité. L'éloigner de sources de bourdonnement telles que des transformateurs ou moteurs.

3. Ne pas ouvrir le coffret car ceci risque d'endommager la platine ou de provoquer des chocs électriques. Si un objet pénètre dans la platine, contacter votre revendeur local.

4. Lorsque vous débranchez l'appareil de la prise murale, tirer toujours la prise directement; ne jamais tirer sur le cordon.

5. Ne pas forcer quand vous faites fonctionner les commutateurs et boutons.

6. Quand vous déplacez l'appareil, assurez-vous qu'il est débranché et retirer tous les câbles le raccordant à d'autres appareils.

7. Ne pas essayer de nettoyer cet appareil avec des diluants chimiques car ceci risque d'abîmer le fini. Utiliser un chiffon propre et sec.

8. Ne jamais approcher d'objets métalliques (par exemple un tournevis, des outils, etc.) de l'ensemble des têtes d'enregistrement/lecture. Ceci non seulement rayerait ou endommagerait le fini lisse comme un miroir des têtes mais aussi risquerait de changer les caractéristiques magnétiques des têtes, provoquant une détérioration de la qualité des performances de reproduction.

9. Bien que la tête d'enregistrement/lecture utilisée dans cet appareil soit une tête amorphe de haute qualité possédant d'excellentes caractéristiques de reproduction, elle peut se salir après l'utilisation de bandes usagées ou à cause de l'accumulation de poussière avec le temps. Ceci peut avoir un effet néfaste sur la qualité de reproduction. Nettoyer régulièrement les têtes avec un des nettoyeurs de têtes du marché ou avec des solutions de nettoyage comme expliqué plus loin dans ce manuel.

10. Bien lire la section "En cas de difficulté" de ce manuel pour trouver la cause d'erreurs de fonctionnement communes avant de conclure que votre appareil est en panne.

11. Garder ce manuel en lieu sûr pour une référence ultérieure.

12. Sélecteur de tension (modèle général uniquement)

Le sélecteur de tension situé sur le panneau arrière de cet appareil doit être réglé sur la tension de ligne locale AVANT de brancher l'appareil sur une prise CA.

Les tensions sont 110/120/220/240V CA, 50/60 Hz.

ATTENTION

POUR EVITER TOUT RISQUE D'INCENDIE OU DE CHOC ELECTRIQUE, NE PAS EXPOSER CET APPAREIL A LA PLUIE NI A L'HUMIDITE

ATTENTION (POUR LE MODELE CANADIEN):

POUR PREVENIR LES CHOCS ELECTRIQUES NE PAS UTILISER CETTE FICHE (POLARISEE AVEC UN PROLONGATEUR, UNE PRISE DE COURANT OU UNE AUTRE SORTIE DE COURANT, SAUF SI LES LAMES PEUVENT ETRE INSEREES A FOND SANS EN LAISSER AUCUNE PARTIE A DECOUVERT.



YAMAHA
HAMAMATSU, JAPAN