

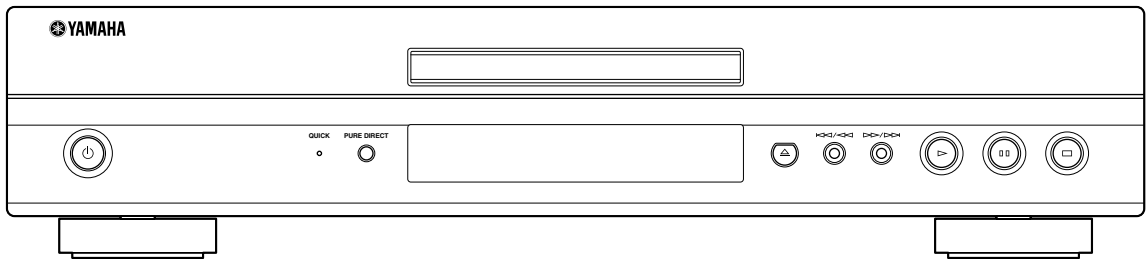

BLU-RAY DISC PLAYER

BD-S1900

OWNER'S MANUAL
MANUAL DE INSTRUCCIONES



IMPORTANT SAFETY INSTRUCTIONS

Read these operating instructions carefully before using the unit. Follow the safety instructions on the unit and the applicable safety instructions listed below. Keep these operating instructions handy for future reference.

- 1 Read these instructions.
- 2 Keep these instructions.
- 3 Heed all warnings.
- 4 Follow all instructions.
- 5 Do not use this apparatus near water.
- 6 Clean only with dry cloth.
- 7 Do not block any ventilation openings. Install in accordance with the manufacturer's instructions.
- 8 Do not install near any heat sources such as radiators, heat registers, stoves, or other apparatus (including amplifiers) that produce heat.
- 9 Do not defeat the safety purpose of the polarized or grounding-type plug. A polarized plug has two blades with one wider than the other. A grounding-type plug has two blades and a third grounding prong. The wide blade or the third prong are provided for your safety. If the provided plug does not fit into your outlet, consult an electrician for replacement of the obsolete outlet.
- 10 Protect the power cord from being walked on or pinched particularly at plugs, convenience receptacles, and the point where they exit from the apparatus.
- 11 Only use attachments/accessories specified by the manufacturer.
- 12 Use only with the cart, stand, tripod, bracket, or table specified by the manufacturer, or sold with the apparatus. When a cart is used, use caution when moving the cart/apparatus combination to avoid injury from tip-over. 
- 13 Unplug this apparatus during lightning storms or when unused for long periods of time.
- 14 Refer all servicing to qualified service personnel. Servicing is required when the apparatus has been damaged in any way, such as power-supply cord or plug is damaged, liquid has been spilled or objects have fallen into the apparatus, the apparatus has been exposed to rain or moisture, does not operate normally, or has been dropped.

WARNING:

TO REDUCE THE RISK OF FIRE, ELECTRIC SHOCK OR PRODUCT DAMAGE,

- **DO NOT EXPOSE THIS APPARATUS TO RAIN, MOISTURE, DRIPPING OR SPLASHING AND THAT NO OBJECTS FILLED WITH LIQUIDS, SUCH AS VASES, SHALL BE PLACED ON THE APPARATUS.**
- **USE ONLY THE RECOMMENDED ACCESSORIES.**
- **DO NOT REMOVE THE COVER (OR BACK); THERE ARE NO USER SERVICEABLE PARTS INSIDE. REFER SERVICING TO QUALIFIED SERVICE PERSONNEL.**

CAUTION!

DO NOT INSTALL OR PLACE THIS UNIT IN A BOOKCASE, BUILT-IN CABINET OR IN ANOTHER CONFINED SPACE.

ENSURE THE UNIT IS WELL VENTILATED. TO PREVENT RISK OF ELECTRIC SHOCK OR FIRE HAZARD DUE TO OVERHEATING, ENSURE THAT CURTAINS AND ANY OTHER MATERIALS DO NOT OBSTRUCT THE VENTILATION VENTS.

CAUTION!

THIS PRODUCT UTILIZES A LASER. USE OF CONTROLS OR ADJUSTMENTS OR PERFORMANCE OF PROCEDURES OTHER THAN THOSE SPECIFIED HEREIN MAY RESULT IN HAZARDOUS RADIATION EXPOSURE. DO NOT OPEN COVERS AND DO NOT REPAIR YOURSELF. REFER SERVICING TO QUALIFIED PERSONNEL.

CAUTION

Danger of explosion if battery is incorrectly replaced. Replace only with the same or equivalent type.

The socket outlet shall be installed near the equipment and easily accessible. The mains plug of the power supply cord shall remain readily operable.

To completely disconnect this apparatus from the AC Mains, disconnect the power supply cord plug from AC receptacle.



CAUTION

**RISK OF ELECTRIC SHOCK
DO NOT OPEN**



CAUTION: TO REDUCE THE RISK OF ELECTRIC SHOCK, DO NOT REMOVE SCREWS. NO USER-SERVICEABLE PARTS INSIDE. REFER SERVICING TO QUALIFIED SERVICE PERSONNEL.



The lightning flash with arrowhead symbol, within an equilateral triangle, is intended to alert the user to the presence of uninsulated "dangerous voltage" within the product's enclosure that may be of sufficient magnitude to constitute a risk of electric shock to persons.



The exclamation point within an equilateral triangle is intended to alert the user to the presence of important operating and maintenance (servicing) instructions in the literature accompanying the appliance.

FCC INFORMATION (for US customers)

1 **IMPORTANT NOTICE: DO NOT MODIFY THIS UNIT!**

This product, when installed as indicated in the instructions contained in this manual, meets FCC requirements.

Modifications not expressly approved by Yamaha may void your authority, granted by the FCC, to use the product.

2 **IMPORTANT:** When connecting this product to accessories and/or another product use only high quality shielded cables. Cable/s supplied with this product **MUST** be used. Follow all installation instructions. Failure to follow instructions could void your FCC authorization to use this product in the USA.

3 **NOTE:** This product has been tested and found to comply with the requirements listed in FCC Regulations, Part 15 for Class "B" digital devices. Compliance with these requirements provides a reasonable level of assurance that your use of this product in a residential environment will not result in harmful interference with other electronic devices. This equipment generates/uses radio frequencies and, if not installed and used according to the instructions found in the users manual, may cause interference harmful to the operation of other electronic devices.

Compliance with FCC regulations does not guarantee that interference will not occur in all installations. If this product is found to be the source of interference, which can be determined by turning the unit "OFF" and "ON", please try to eliminate the problem by using one of the following measures:

Relocate either this product or the device that is being affected by the interference.

Utilize power outlets that are on different branch (circuit breaker or fuse) circuits or install AC line filter/s.

In the case of radio or TV interference, relocate/reorient the antenna. If the antenna lead-in is 300 ohm ribbon lead, change the lead-in to coaxial type cable.

If these corrective measures do not produce satisfactory results, please contact the local retailer authorized to distribute this type of product. If you can not locate the appropriate retailer, please contact Yamaha Electronics Corp., U.S.A. 6660 Orangethorpe Ave., Buena Park, CA 90620.

The above statements apply **ONLY** to those products distributed by Yamaha Corporation of America or its subsidiaries.

COMPLIANCE INFORMATION STATEMENT (DECLARATION OF CONFORMITY PROCEDURE)

Responsible Party: Yamaha Electronics Corporation, U.S.A.
Address: 6660 Orangethorpe Avenue
Buena Park, CA 90620
Telephone: 714-522-9105
1-800-492-6242 (toll free)
Fax: 714-228-3390
Type of Equipment: Blu-ray Disc Player
Model Name: BD-S1900

- This device complies with Part 15 of the FCC Rules.
 - Operation is subject to the following conditions:
 - This device may not cause harmful interference.
 - This device must accept any interference received including interference that may cause undesired operation.
- See the "Troubleshooting" section at the end of this manual if interference to radio reception is suspected.

We Want You Listening For A Lifetime



Yamaha and the Electronic Industries Association's Consumer Electronics Group want you to get the most out of your equipment by playing it at a safe level. One that lets the sound come through loud and clear without annoying blaring or distortion - and, most importantly, without affecting your sensitive hearing.

Since hearing damage from loud sounds is often undetectable until it is too late, Yamaha and the Electronic Industries Association's Consumer Electronics Group recommend you to avoid prolonged exposure from excessive volume levels.

IMPORTANT

Please record the serial number of this unit in the space below.

MODEL:

Serial No.:

The serial number is located on the rear of the unit.

Retain this Owner's Manual in a safe place for future reference.

CAUTION: READ THIS BEFORE OPERATING YOUR UNIT.

- 1 To assure the finest performance, please read this manual carefully. Keep it in a safe place for future reference.
- 2 Install this sound system in a well ventilated, cool, dry, clean place—away from direct sunlight, heat sources, vibration, dust, moisture, and/or cold. For proper ventilation, allow the following minimum clearances.
Top : 10 cm (3-7/8 in)
Rear: 10 cm (3-7/8 in)
Side: 10 cm (3-7/8 in)
- 3 Locate this unit away from other electrical appliances, motors, or transformers to avoid humming sounds.
- 4 Do not expose this unit to sudden temperature changes from cold to hot, and do not locate this unit in an environment with high humidity (i.e. a room with a humidifier) to prevent condensation inside this unit, which may cause an electrical shock, fire, damage to this unit, and/or personal injury.
- 5 Avoid installing this unit where foreign object may fall onto this unit and/or this unit may be exposed to liquid dripping or splashing. On the top of this unit, do not place:
 - Other components, as they may cause damage and/or discoloration on the surface of this unit.
 - Burning objects (i.e. candles), as they may cause fire, damage to this unit, and/or personal injury.
 - Containers with liquid in them, as they may fall and liquid may cause electrical shock to the user and/or damage to this unit.
- 6 Do not cover this unit with a newspaper, tablecloth, curtain, etc. in order not to obstruct heat radiation. If the temperature inside this unit rises, it may cause fire, damage to this unit, and/or personal injury.
- 7 Do not plug in this unit to a wall outlet until all connections are complete.
- 8 Do not operate this unit upside-down. It may overheat, possibly causing damage.
- 9 Do not use force on switches, knobs and/or cords.
- 10 When disconnecting the power cord from the wall outlet, grasp the plug; do not pull the cord.
- 11 Do not clean this unit with chemical solvents; this might damage the finish. Use a clean, dry cloth.
- 12 Only voltage specified on this unit must be used. Using this unit with a higher voltage than specified is dangerous and may cause fire, damage to this unit, and/or personal injury. Yamaha will not be held responsible for any damage resulting from use of this unit with a voltage other than specified.
- 13 To prevent damage by lightning, keep the power cord disconnected from a wall outlet or this unit during a lightning storm.
- 14 Do not attempt to modify or fix this unit. Contact qualified Yamaha service personnel when any service is needed. The cabinet should never be opened for any reasons.
- 15 When not planning to use this unit for long periods of time (i.e. vacation), disconnect the AC power plug from the wall outlet.
- 16 Be sure to read the “Troubleshooting” section on common operating errors before concluding that this unit is faulty.
- 17 Before moving this unit, press  to set this unit to the standby mode, and disconnect the AC power plug from the wall outlet.
- 18 Condensation will form when the surrounding temperature changes suddenly. Disconnect the power cable from the outlet, then leave this unit alone.
- 19 When using this unit for a long time, this unit may become warm. Turn the power off, then leave this unit alone for cooling.
- 20 Install this unit near the AC outlet and where the AC power plug can be reached easily.
- 21 The batteries shall not be exposed to excessive heat such as sunshine, fire or the like.

This unit is not disconnected from the AC power source as long as it is connected to the wall outlet, even if this unit itself is turned off by . This state is called the standby mode. In this state, this unit is designed to consume a very small quantity of power.

WARNING

TO REDUCE THE RISK OF FIRE OR ELECTRIC SHOCK, DO NOT EXPOSE THIS UNIT TO RAIN OR MOISTURE.

The laser component in this product is capable of emitting radiation exceeding the limit for Class 1.

FOR CANADIAN CUSTOMERS

To prevent electric shock, match wide blade of plug to wide slot and fully insert.

This Class B digital apparatus complies with Canadian ICES-003.

POUR LES CONSOMMATEURS CANADIENS

Pour éviter les chocs électriques, introduire la lame la plus large de la fiche dans la borne correspondante de la prise et pousser jusqu'au fond.

Cet appareil numérique de la classe B est conforme à la norme NMB-003 du Canada.

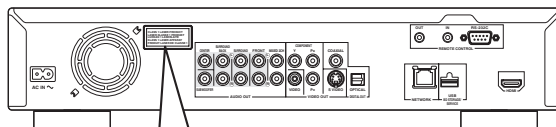

CLASS 1 LASER PRODUCT
LASER KLASSE 1 PRODUKT
LUOKAN 1 LASERLAITE
KLASS 1 LASER APPARAT
PRODUIT LASER DE CLASSE 1

Contents

1

1. INTRODUCTION

About Discs	2
Types of Discs that Can Be Used with This Player.....	2
Discs that Cannot Be Used with This Player.....	3
Disc Precautions	4
Getting Started	5
Supplied accessories	5
The Icons Used in This Operation Manual.....	5
Copyright.....	5
Controls and Functions	6
Front panel.....	6
Rear panel.....	6
Remote Control.....	7

2. CONNECTION

Introduction to Connections	8
Video/audio terminal on this Player.....	8
Video jacks on this Player (Connect ①, ②, or ③).....	8
Audio terminals/jacks on this Player (Connect ①, ②, or ③).....	8
Broadband Internet connection.....	8
USB device connection	8
HDMI Connection	9
Connecting to the HDMI Terminal	9
Video Connections	10
Connecting to the Component Jacks	10
Connecting to the S Video or Video Jack.....	11
Audio Connections	12
Connecting to the Digital Audio Jack/Terminal.....	12
Connecting to the Audio Jacks	13
Broadband Internet Connection	14
Connecting to the NETWORK terminal and USB BD STORAGE/SERVICE terminal	14
Other Connections	15
Connecting to the REMOTE CONTROL jacks	15
Connecting the power cable	15

3. DISC PLAYBACK

Before Starting Playback	16
Loading the Batteries in the Remote Control	16
Turning the Power On	16
Indicators on the front panel display	16
Setting the on-screen display language	17
Updating the software of this unit	17
Setting the audio output.....	18
Preparing for BD-LIVE.....	18
Activating the Secondary Audio.....	18
Controlling the Blu-ray disc player using the HDMI™ control function	18
BD/DVD/CD Playback	20
Loading a Disc.....	20
Basic playback operation.....	20
Enjoying pure hi-fi sound (Pure Direct function).....	21
Repeat Playback	21
Using BD/DVD Menus	22
Using DVD-R/-RW Menu.....	22
Using the Audio CD Playback Menu	24
Enjoying BONUSVIEW or BD-LIVE	24
Function Control Screen.....	25
Displaying the disc information	27

JPEG File Playback	28
Playing back still images in sequence.....	28
Playing back still images in a selected folder.....	28
Playing back Slide Show.....	28
Setting slide show speed/repeat playback	28

4. SETTINGS

Settings	29
Common operations	29
Audio Video Settings.....	30
Speaker Settings	32
Quick Start	33
Auto Power Off.....	33
HDMI Control.....	33
Playback Setting.....	33
Version	34
System Reset.....	34
Communication Setup.....	34
USB Memory Management	36
Software Update.....	37

5. ADDITIONAL INFORMATION

Troubleshooting	39
Power	39
Basic Operation.....	39
Disc Playback.....	39
Picture	39
Sound	40
Network.....	40
Other.....	41
Messages Relating to BD disc and DVD disc.....	41
Glossary	42
Specifications	43
General	43
Audio Performance	43
Input/Output	43

(at the end of this manual)

Information about software	i
----------------------------------	---

2

3

4

5

English

About Discs







■ Types of Discs that Can Be Used with This Player

- The following discs can be played back in this Player. Do not use an 8 cm (3”) to 12 cm (5”) adapter.
- Use discs that conform to compatible standards as indicated by the presence of official logos on the disc label. Playback of discs not complying with these standards is not guaranteed. In addition, the image quality or sound quality is not guaranteed even if the discs can be played back.

Disc Type	Recording Format	Contents	Disc Size
BD video	--	Audio + Video (Movie)	12 cm (5")
BD-RE DL BD-R DL	BDMV format		
DVD Video	Video format	Audio + Video (Movie)	12 cm (5") 8 cm (3")
DVD+RW/ DVD+R DVD+R DL DVD-R DL DVD-RW/ DVD-R	Video/VR/ AVCHD format (finalized disc only)	Audio + Video (Movie)	12 cm (5") 8 cm (3")
Audio CD*1	Audio CD (CD-DA)	Audio	12 cm (5") 8 cm (3")
CD-RW/CD-R	Audio CD (CD-DA) JPEG*2	Audio Still image (JPEG file)	

*1 This Player has been designed on the premise of playing back Audio CDs that comply with CD (Compact Disc) standards. CDs containing a signal for the purpose of protecting copyrights (copy control signal) may not be able to be played back with this Player.







*2 Refer to "About the JPEG file format" on page 3.

Region management information		
Model	BD-Video	DVD-Video
Australia	Region code "B" or "ALL" 	Region number "4" or "ALL" 
Russia	Region code "C" or "ALL" 	Region number "5" or "ALL" 
Asia	Region code "A" or "ALL" 	Region number "3" or "ALL" 

- BD/DVD video players and discs have region codes, which dictate the regions in which a disc can be played. For the region codes, refer to "Region management information" (p. 2)
- BD/DVD Video operations and functions may be different from the explanations in this manual and some operations may be prohibited due to disc manufacturer's settings.
- If a menu screen or operating instructions are displayed during playback of a disc, follow the operating procedure displayed.
- The audio component of a DVD video recorded at 96 kHz (Linear PCM) will be output as 48 kHz audio during playback.

Notes

- Playback for some of the discs in the left side column tables may not be possible depending on the disc.
- "Finalize" refers to a recorder processing a recorded disc so that it will play in other DVD players/recorders as well as this Player. Only finalized DVD discs will play back in this Player. (This Player does not have a function to finalize discs.)

Region management information		
Model	BD-Video	DVD-Video
U.S.A	Region code "A" or "ALL" 	Region number "1" or "ALL" 
South America	Region code "A" or "ALL" 	Region number "4" or "ALL" 
Europe	Region code "B" or "ALL" 	Region number "2" or "ALL" 

■ Discs that Cannot Be Used with This Player

The following discs cannot be played back or will not play back properly on this Player. If such a disc is mistakenly played back, speaker damage may occur.

CDG, Video CD, Photo CD, CD-ROM, CD-TEXT, SVCD, SA-CD, PD, CDV, CVD, DVD-RAM, DVD-Audio, BD-RE with the cartridge, CD-MP3, CD-WMA

Discs with unusual shapes cannot be played.

- Discs with unusual shapes (heart-shaped or hexagonal discs, etc.) cannot be used. The use of such discs will cause malfunction.

The following BD/DVD video discs cannot be played.

- Discs not match the region code/number of this Player (“Region management information”, p. 2).
- Discs produced illegally.
- Discs recorded for commercial use.

About the JPEG file format

JPEG is a type of file format for storing still-image files (photos, illustrations, etc.). The Player lets you play JPEG format still-image files.

File formats that are not compatible.

- Still images in formats other than JPEG (such as TIFF) cannot be played.
- There may be some files that cannot be played even if they are in JPEG format.
- Progressive JPEG files cannot be played.
- Moving image files and audio files as well as Motion JPEG format files cannot be played, even though they are JPEG files.

Other files that cannot be played back.

- You may not be able to play some still images which you have created, touched up, copied or otherwise edited on your computer.

You may experience one or more of the following symptoms when playing files.

- It may take some time to play files depending on the number of folders, number of files and volume of data involved.
- EXIF information will not be displayed. EXIF stands for Exchangeable Image File Format, and is a standard for storing interchange information in image files, especially those using JPEG compression. (Refer to <http://exif.org> for more information.)

When using the unit to play a CD-RW/R disc with still images stored (recorded).

- With CD-RW/R discs on which still images are mixed in with music or movies, you will be able to play only the still images. You may not be able to play some of these discs at all.
- Multi-session discs cannot be played.
- You may not be able to play some still images you have processed (rotated or saved by overwriting other images) using image processing software or some still images you have imported from the Internet or e-mail.
- The discs which this Player can play back (recognize) are limited to the following properties:
 - Contains EXIF format files
 - Picture resolution: Between 32x32 and 7680x4320 pixels
 - Maximum number of folders: 256
 - Maximum number of files: 256 per folder
 - File size: 20MB or less

Structure of still images (JPEG) folders

- You can play still images (JPEG) with this unit by making folder on disc as shown below. Images situated on the root directly cannot be played back.

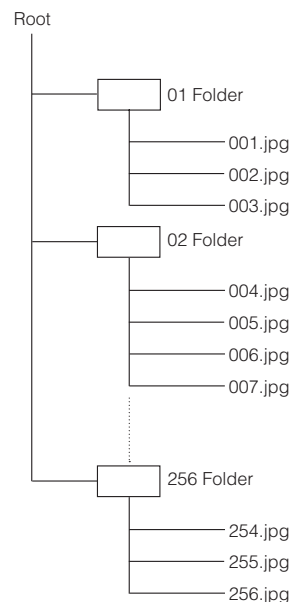





■ Disc Precautions

Be Careful of Scratches and Dust

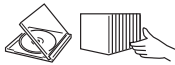
- BD, DVD and CD discs are sensitive to dust, fingerprints and especially scratches. A scratched disc may not be able to be played back. Handle discs with care and store them in a safe place.

Proper Disc Storage

Place the disc in the center of the disc case and store the case and disc upright.	
Avoid storing discs in locations subject to direct sunlight, close to heating appliances or in locations of high humidity.	
Do not drop discs or subject them to strong vibrations or impacts.	
Avoid storing discs in locations where there are large amounts of dust or moisture.	

Handling Precautions



- If the surface is soiled, wipe gently with a soft, damp (water only) cloth. When wiping discs, always move the cloth from the center hole toward the outer edge.



- Do not use record cleaning sprays, benzene, thinner, static electricity prevention liquids or any other solvent.
- Do not touch the surface.
- Do not stick paper or adhesive labels to the disc.
- If the playing surface of a disc is soiled or scratched, the Player may decide that the disc is incompatible and eject the disc tray, or it may fail to play the disc correctly. Wipe any dirt off the playing surface with a soft cloth.

Cleaning the Pick Up Lens

- Never use commercially available cleaning discs. The use of these discs can damage the lens.
- Request the nearest service center approved by Yamaha to clean the lens.

Warnings about dew formation

- Condensation may form on pick up lens or disc in the following conditions:
 - Immediately after a heater has been turned on.
 - In a steamy or very humid room.
 - When the Player is suddenly moved from a cold environment to a warm one.

When condensation forms:

- It becomes difficult for the Player to read the signals on the disc and prevents the Player from operating properly.

To remove condensation:

- Take out the disc and leave the Player with the power off until the condensation disappears. Using the Player when there is condensation may cause malfunction.

Controls and Functions

■ Front panel

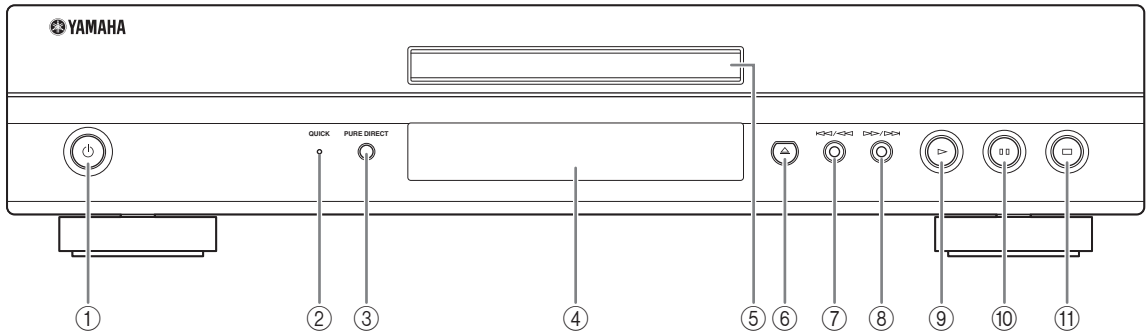

- ① **⏻ (Power)** (p. 20)
- ② **QUICK** indicator (p. 33)
- ③ **PURE DIRECT** (p. 21)
- ④ **Front panel display** (p. 16)
- ⑤ **Disc tray** (p. 20)
- ⑥ **▲ (Eject)** (p. 20)
- ⑦ **⏮/⏮ (Search backward/Skip backward)** (p. 20)
- ⑧ **⏭/⏭ (Search forward/Skip forward)** (p. 20)
- ⑨ **▶ (Play)** (p. 20)
- ⑩ **⏸ (Pause)** (p. 20)
- ⑪ **■ (Stop)** (p. 20)

■ Rear panel

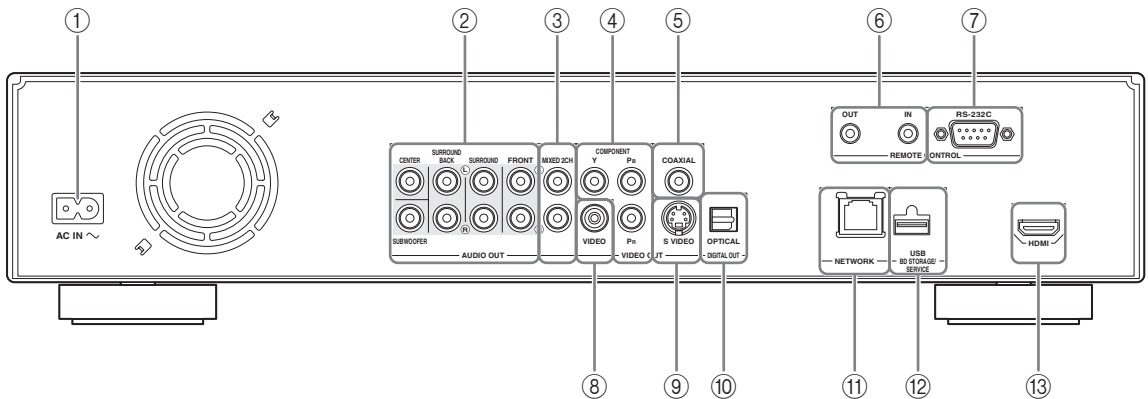

- ① **AC IN** (p. 15)
- ② **AUDIO OUT (8ch discrete)** (p. 13)
- ③ **AUDIO OUT (MIXED 2CH)** (p. 13)
- ④ **COMPONENT** (p. 10)
- ⑤ **DIGITAL OUT (COAXIAL)** (p. 12)
- ⑥ **REMOTE CONTROL (IN/OUT)** (p. 15)
- ⑦ **REMOTE CONTROL (RS-232C)** (p. 15)
- ⑧ **VIDEO** (p. 11)
- ⑨ **S VIDEO** (p. 11)
- ⑩ **DIGITAL OUT (OPTICAL)** (p. 12)
- ⑪ **NETWORK** (p. 14)
- ⑫ **USB BD STORAGE/SERVICE** (p. 14)
- ⑬ **HDMI** (p. 9)

■ Remote Control

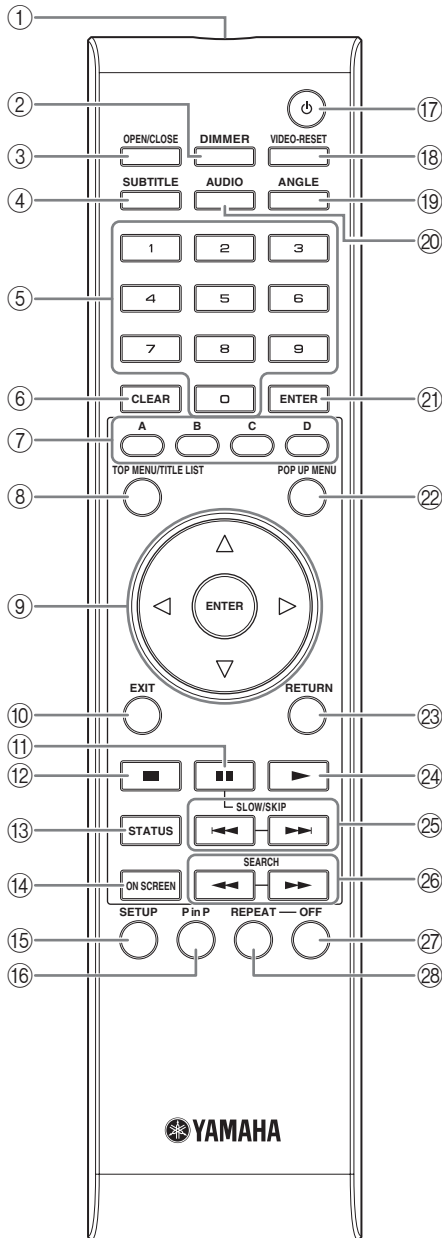

- ① Infrared signal transmitter (p. 16)
- ② DIMMER (p. 16)
- ③ OPEN/CLOSE (p. 20)
- ④ SUBTITLE (p. 26)
- ⑤ Number buttons (p. 26)
- ⑥ CLEAR (p. 29)
- ⑦ A, B, C, D (p. 23, 24, 28, 35)
- ⑧ TOP MENU/TITLE LIST (p. 22, 23)
- ⑨ Cursor buttons (▲ / ▼ / ◀ / ▶), ENTER (p. 17, 30)

- ⑩ EXIT (p. 28, 29, 30)
- ⑪ ■■ (Pause) (p. 20)
- ⑫ ■ (Stop) (p. 20)
- ⑬ STATUS (p. 21, 27)
- ⑭ ON SCREEN (p. 26)
- ⑮ SETUP (p. 17, 28, 29)
- ⑯ P in P (p. 25)
- ⑰ ⏻ (Power) (p. 16)
- ⑱ VIDEO-RESET (p. 30, 31)
- ⑲ ANGLE (p. 26)
- ⑳ AUDIO (p. 26)
- ㉑ ENTER (p. 30, 37)
- ㉒ POP UP MENU (p. 22)
- ㉓ RETURN (p. 21, 24, 26, 28, 29)
- ㉔ ▶ (Play) (p. 20)
- ㉕ ◀◀ / ▶▶ (SLOW/SKIP) (p. 20)
- ㉖ ◀◀ / ▶▶ (SEARCH) (p. 20)
- ㉗ OFF (p. 21)
- ㉘ REPEAT (p. 21, 26)

ID function

You can change the remote control ID to prevent unwanted operation of the other Yamaha player such as DVD player. If you have changed the remote control ID, make sure that you select the same ID for the main unit. The default setting is ID1.

① Remote control setting

To change the ID from ID1 to ID2, press and hold **A** and **2** simultaneously for 3 seconds.

To change the ID from ID2 to ID1, press and hold **A** and **1** simultaneously for 3 seconds.

② Main unit setting

Press and hold ◀◀◀ and ▶▶▶▶ on the front panel simultaneously for 2 seconds while no disc is inserted in this Player and the disc tray is closed (current ID is displayed). Keep pressing and holding the keys for another 2 seconds to change the ID between ID1 and ID2.

Note

- If the remote control is without batteries for a few minutes or if exhausted batteries remain in the remote control, the remote control ID is automatically set to ID1. If you want to use the remote control in ID2 setting, install new batteries and set the remote control ID again.

Introduction to Connections

This Player is equipped with the terminals/jacks listed below. Find the corresponding terminal/jack on your video/audio equipment. We recommend that you use the HDMI terminal which provides high quality digital audio and video on a single connection. If you use the other terminals/jacks, connect the video first. Then connect the audio.

■ Video/audio terminal on this Player

① HDMI terminal



Page 9

■ Video jacks on this Player (Connect ①, ②, or ③)

Higher Quality



Standard Quality

① VIDEO OUT (COMPONENT) jacks

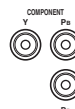

Page 10

② VIDEO OUT (S VIDEO) jack



Page 11

③ VIDEO OUT (VIDEO) jack



Page 11

■ Audio terminals/jacks on this Player (Connect ①, ②, or ③)

① DIGITAL OUT (COAXIAL/
OPTICAL) jack/terminal



Page 12

② AUDIO OUT (8ch discrete) jacks

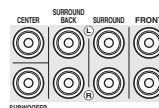

Page 13

③ AUDIO OUT (MIXED 2CH) jacks



Page 13

■ Broadband Internet connection

NETWORK terminal



Page 14

■ USB device connection

USB BD STORAGE/SERVICE
terminal



Page 14

HDMI Connection

■ Connecting to the HDMI Terminal

- You can enjoy high quality digital picture and sound through the HDMI terminal.
- Firmly connect an HDMI cable (commercially available) to the HDMI terminals (① and ②).
- See page 38 for information on the audio output formats.
- Use HIGH SPEED HDMI cables that have the HDMI logo (as shown on the cover).

Caution!

Be sure to turn off this Player and the equipment before making any connections.

Hint

- When using an HDMI output, 7.1 ch Digital Output is available.

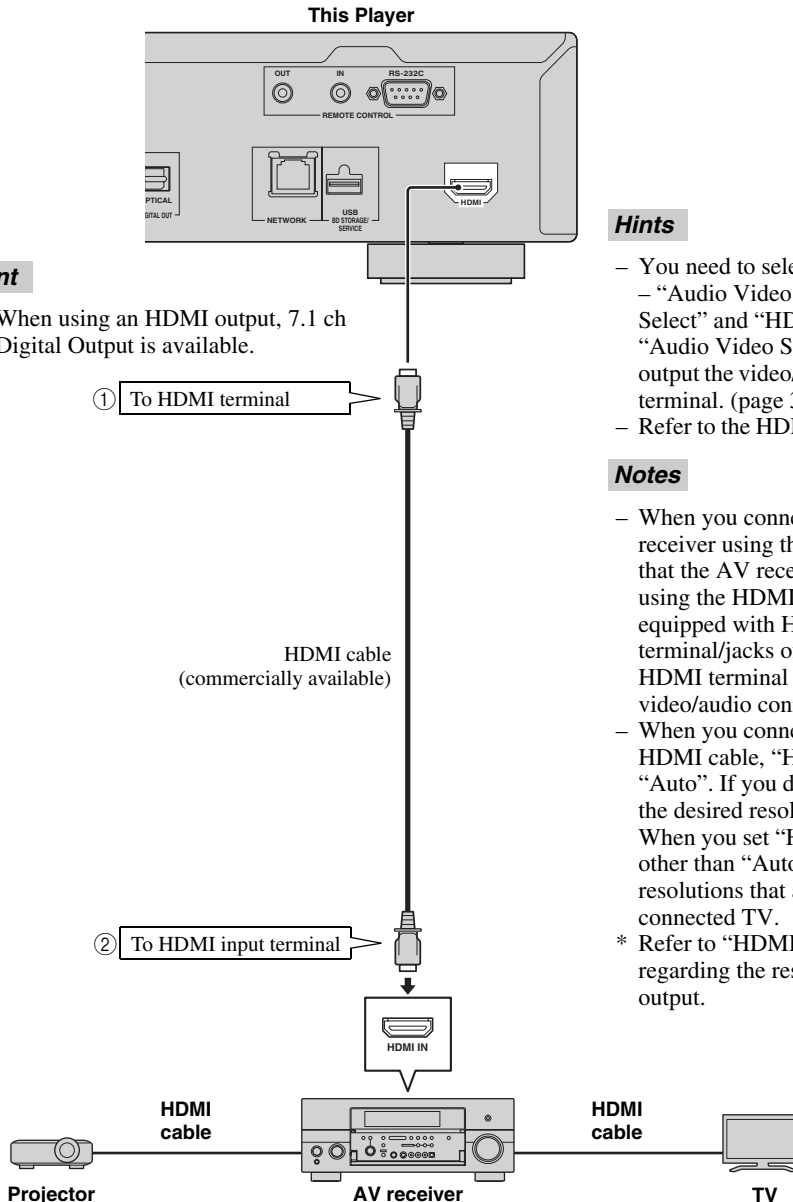

Hints

- You need to select the "HDMI" in "Settings" - "Audio Video Settings" - "Video Out Select" and "HDMI Output" in "Settings" - "Audio Video Settings" - "Audio Out" to output the video/audio signals from the HDMI terminal. (page 31)
- Refer to the HDMI control function. (Page 18)

Notes

- When you connect this Player to an AV receiver using the HDMI terminal, make sure that the AV receiver is connected to a TV using the HDMI terminal. If the TV is not equipped with HDMI terminal, connect the terminal/jacks of this Player other than the HDMI terminal to the AV receiver for the video/audio connections.
 - When you connect the Player to a TV with an HDMI cable, "HDMI Video Out" is set to "Auto". If you don't get a stable image, select the desired resolution*.
- When you set "HDMI Video Out" to a setting other than "Auto", you can only select resolutions that are compatible with the connected TV.
- * Refer to "HDMI Video Out" on page 31 regarding the resolutions of the HDMI video output.

Video Connections

■ Connecting to the Component Jacks

- You can enjoy accurate color reproduction and high quality images through the component jacks.
- Firmly connect a component video cable (commercially available) to the component jacks (① and ②).

Caution!

Be sure to turn off this Player and the equipment before making any connections.

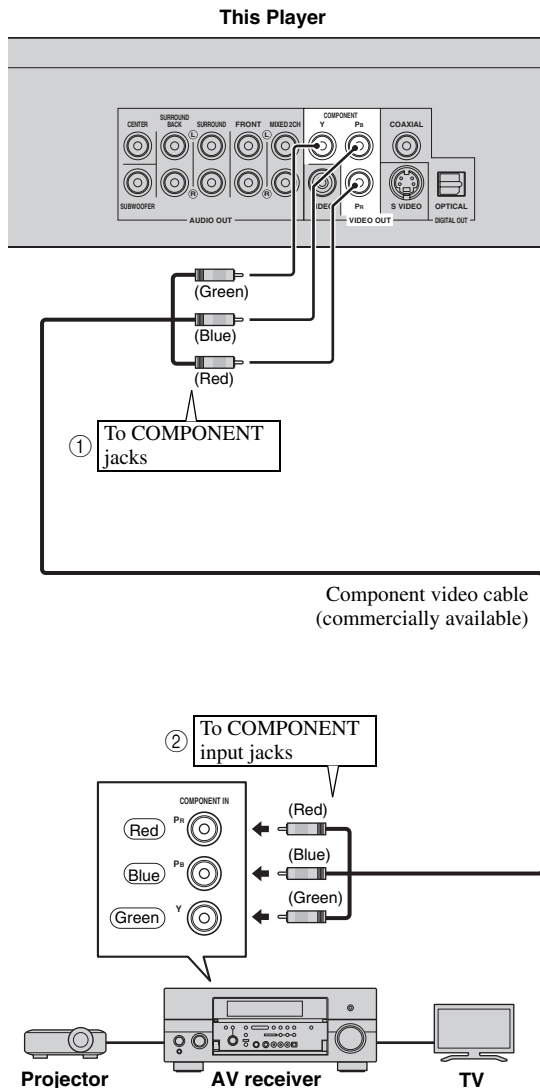

Notes

- You need to select "Component" in "Settings" - "Audio Video Settings" - "Video Out Select" to output the video signal from the component jacks. (See page 31.)
- When the priority video output is set to "HDMI" in "Video Out Select", the video resolution which is output from the COMPONENT jacks is the one set in "HDMI Video Out".
- When the output from the COMPONENT jacks is prioritized, set the priority video output to "Component".
- If you play back the image via VCR, the image may deteriorate due to the copy guard function.
- When you watch the program where copyright is protected, we recommend that the Blu-ray disc player be connected to LCD TV directly or via AV receiver.

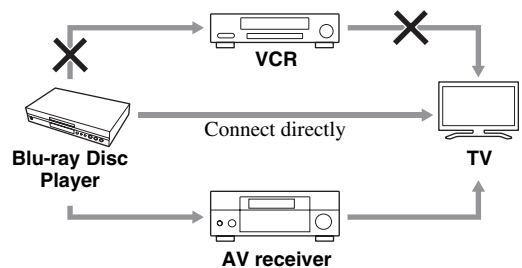

■ Connecting to the S Video or Video Jack

- Connect either the S-video jack or video jack.
- Firmly connect a S-video cable (commercially available) to the S-video jacks or a video pin cable (supplied) to the video jacks (① and ②, or ③ and ④).

Caution!

Be sure to turn off this Player and the equipment before making any connections.

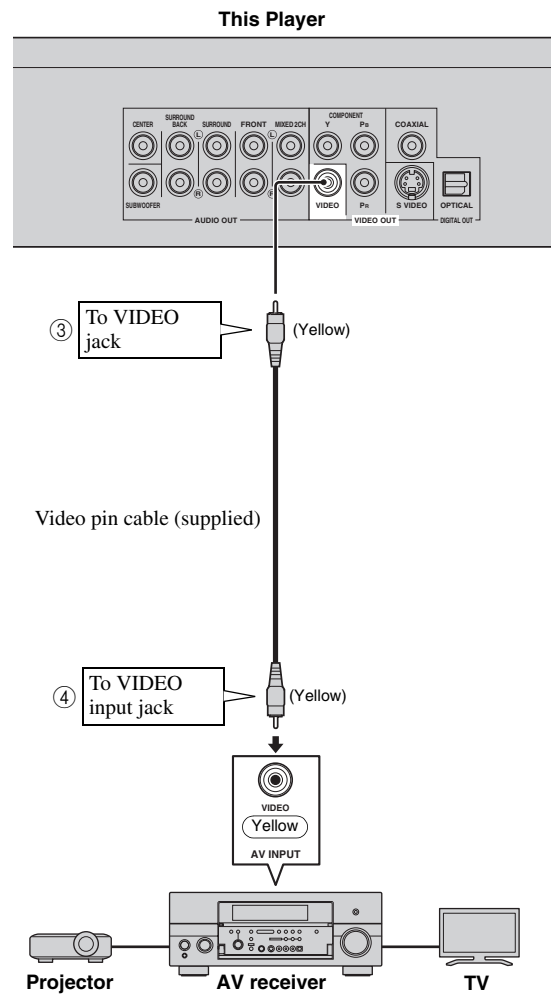
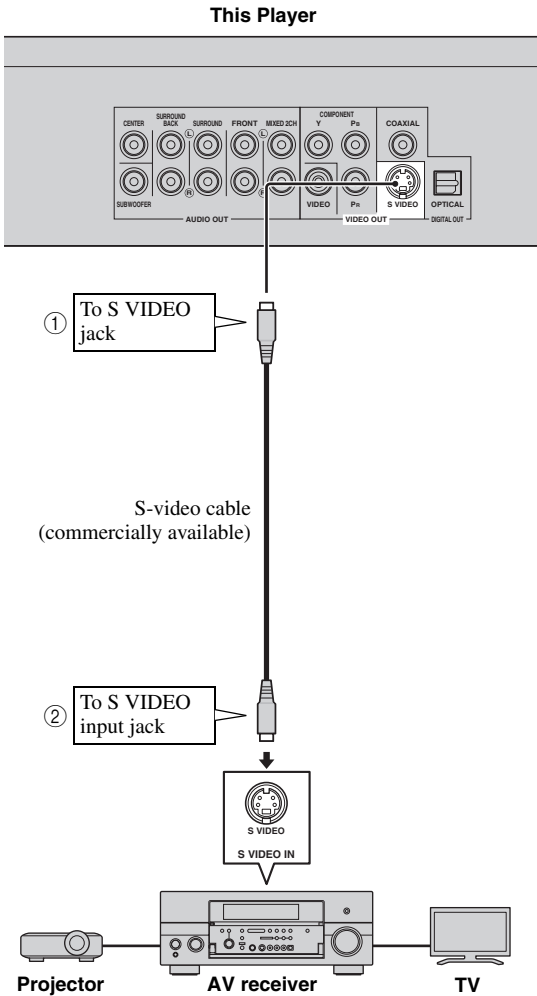

Notes

- You need to select "Component" in "Settings" - "Audio Video Settings" - "Video Out Select" to output the video signal from the S-video/video jack. (See page 31.)
- If you play back the image via VCR, the image may deteriorate due to the copy guard function.
- When you watch the program where copyright is protected, we recommend that the Blu-ray disc player be connected to LCD TV directly or via AV receiver.

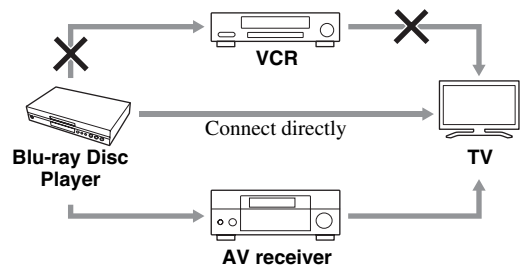

Audio Connections

■ Connecting to the Digital Audio Jack/Terminal

- You can connect audio equipment or the TV to the DIGITAL OUT Jack/terminal.
- Firmly connect a digital audio pin cable (commercially available) or optical cable (commercially available) to the coaxial digital audio jack or optical digital audio terminal (① and ②, or ③ and ④).
- See page 38 for information on the audio output formats.

Caution!

Be sure to turn off this Player and the equipment before making any connections.

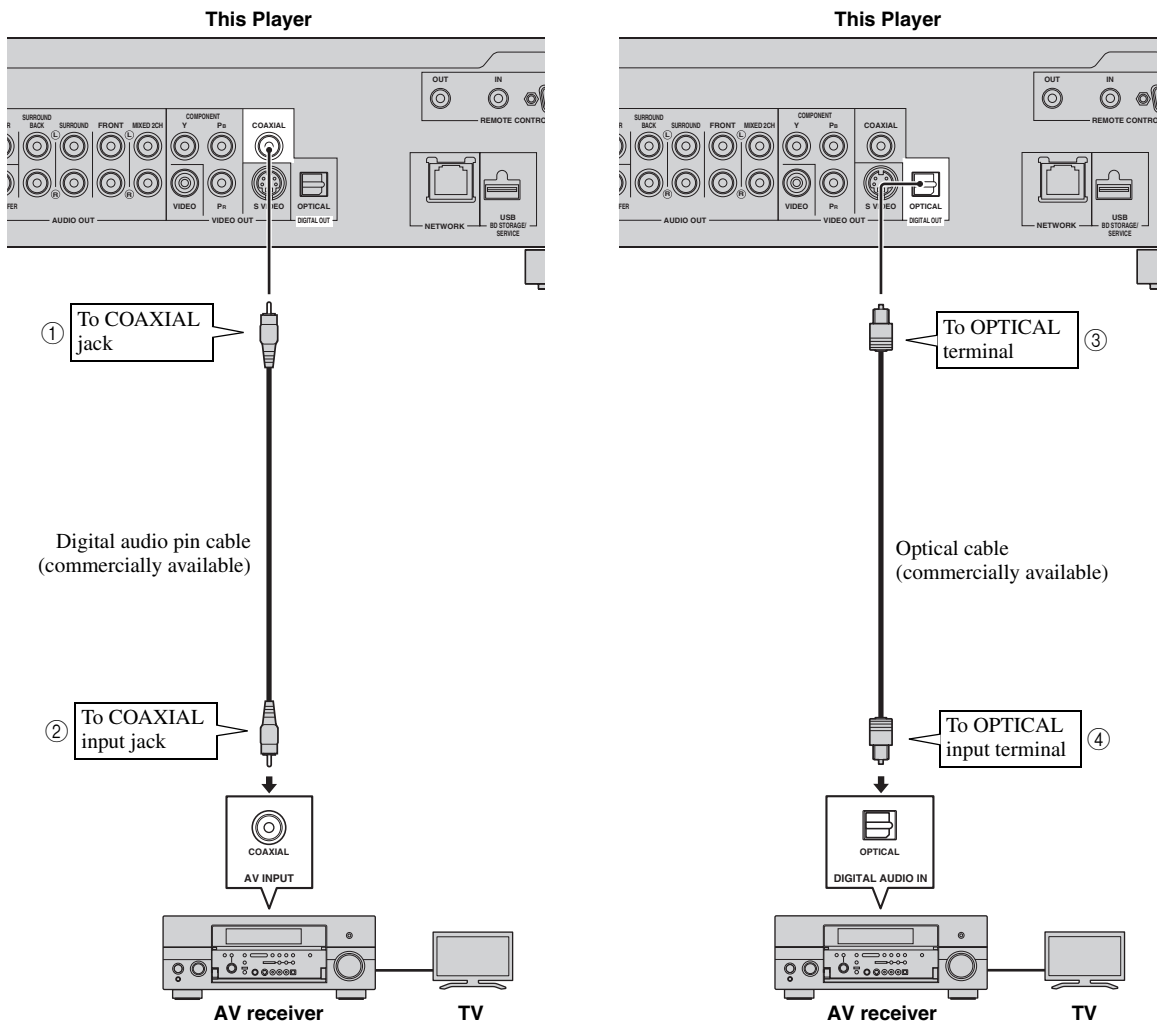

Hints

- When using COAXIAL/OPTICAL output, 5.1 ch Digital Output is available. 7.1 ch Digital Output is not available.
- You need to select "Digital Output" in "Settings" - "Audio Video Settings" - "Audio Out" to output the audio signal from the coaxial or optical jack/terminal. (See page 31.)

Note

- 7.1 ch Audio is available via the HDMI terminal or the 8ch discrete audio jacks.

■ Connecting to the Audio Jacks

- You can connect audio equipment or the TV to the AUDIO OUT Jacks.
- Firmly connect an audio pin cable (supplied) or audio pin cables (supplied for 2ch and commercially available for the other 6ch) to the 2ch audio jacks or 8ch discrete audio jacks (① and ②, or ③ and ④).
- See page 38 for information on the audio output formats.

Caution!

Be sure to turn off this Player and the equipment before making any connections.

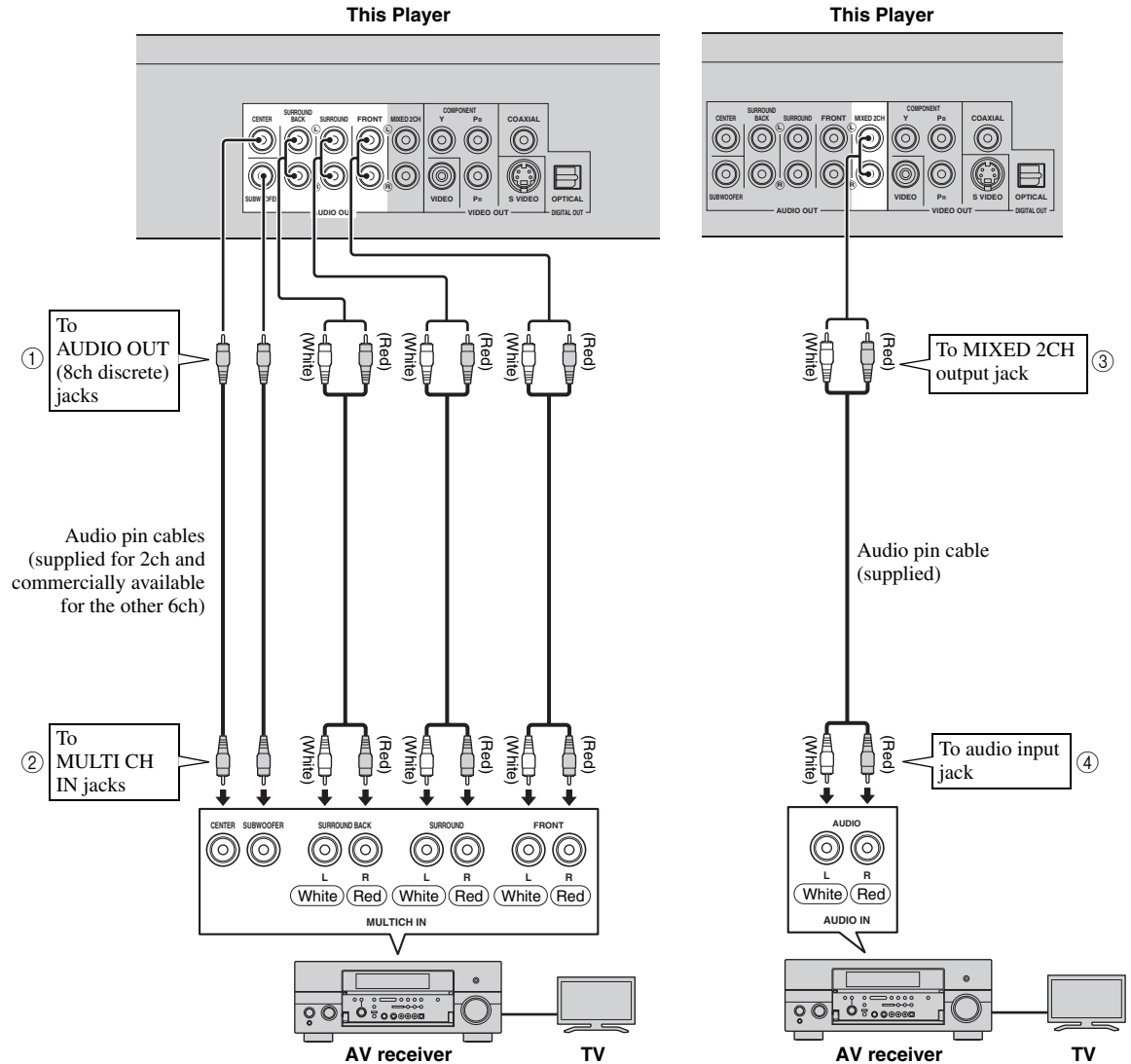

Hints

- You can connect a subwoofer to the SUBWOOFER jack directly. When you connect TV to this Player directly, connect an active subwoofer such as Yamaha Active Servo Processing Subwoofer System to this jack.
- You need to select "7.1ch Audio Output" in "Settings" - "Audio Video Settings" - "Audio Out" to output the audio signal from the 8ch discrete jacks. (See page 31.)
- You need to select "2ch Audio Output" in "Settings" - "Audio Video Settings" - "Audio Out" to output the audio signal from the 2ch audio jacks. (See page 31.)

Broadband Internet Connection

■ Connecting to the NETWORK terminal and USB BD STORAGE/SERVICE terminal

- You can enjoy a variety of contents with interactive functions by connecting to the internet when playing BD-LIVE compatible discs. Refer to pages 24 and 25 regarding further information on BD-LIVE functions.
- You can connect a USB memory device (2GB or greater and formatted with FAT 32/16) to the USB BD STORAGE/SERVICE terminal to save the Virtual Package/BD-LIVE data or to update the software of this Player.
- Firmly connect a network cable (commercially available) and a USB memory device (commercially available) to the NETWORK terminal and USB BD STORAGE/SERVICE terminal (① and ②, and ③).
- Use only an STP (shielded twisted pair) network cable.
- When using the internet, a broadband internet connection as shown below is required.

Caution!

Be sure to turn off this Player and the equipment before making any connections.

Notes

- When using a broadband internet connection, a contract with an internet service provider is required. For more details, contact your nearest internet service provider.
- Refer to the operation manual of the equipment you have as the connected equipment and connection method may differ depending on your internet environment.
- Use a network cable/router supporting 10BASE-T/100BASE-TX.

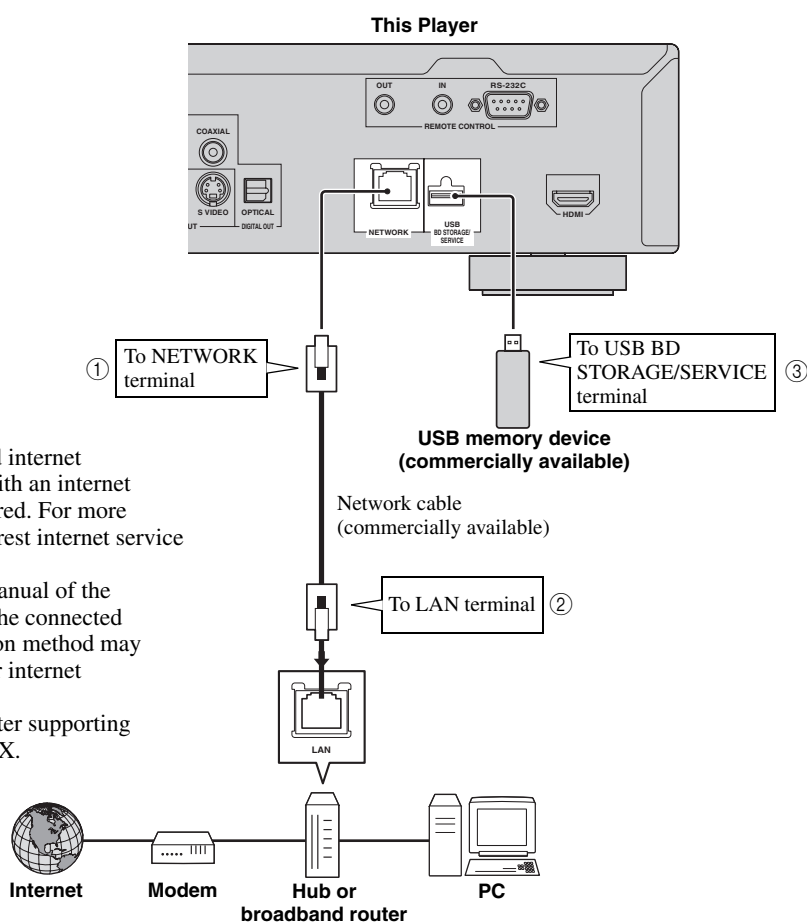

After connecting

- Perform the communication setting. (Page 34–36)
- Load a BD-LIVE compatible disc and play back the contents. (Page 20–24)

Other Connections

■ Connecting to the REMOTE CONTROL jacks

- You can transmit the remote control signals by connecting to the REMOTE CONTROL (OUT/IN) jacks.
- Firmly connect 3.5mm mini plug cables (commercially available) to the REMOTE CONTROL (OUT/IN) jacks (① and ②, or ③ and ④).

Caution!

Be sure to turn off this Player and the equipment before making any connections.

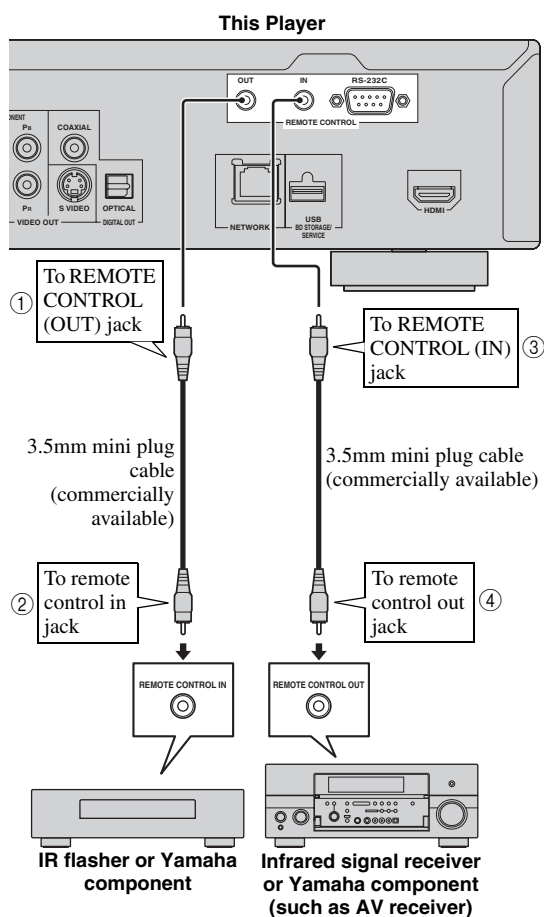

Hint

- The RS-232C terminal is a control expansion terminal for commercial use. Consult your dealer for details.

■ Connecting the power cable

- Plug the supplied power cable into the AC IN terminal on the rear of the Player. Then plug into AC outlet.

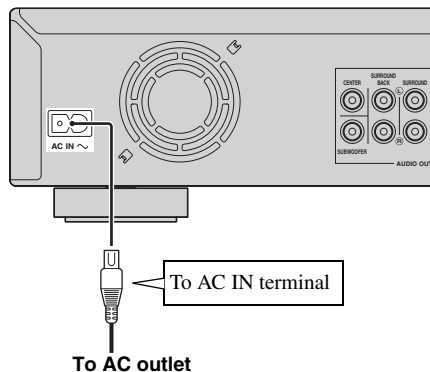

Note

- TO PREVENT RISK OF ELECTRIC SHOCK, DO NOT TOUCH THE UN-INSULATED PARTS OF ANY CABLES WHILE THE POWER CABLE IS CONNECTED.

Before Starting Playback

■ Loading the Batteries in the Remote Control

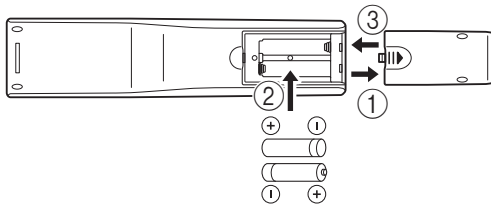

- ① Press the part and slide the battery compartment cover off.
- ② Insert the two supplied batteries (AAA, R03, UM-4), following the indications (+/-) on the inside of the compartment.
- ③ Slide the cover back until it snaps into place.

Notes

- Do not subject the remote control unit to shock, water or excessive humidity.
- The remote control unit may not function if the Player's remote sensor is in direct sunlight or any other strong light.
- Incorrect use of batteries may cause them to leak or burst. Read the battery warnings and use the batteries properly.
- Do not mix old and new batteries, or mix different brands.
- Remove the batteries if you will not use the remote control unit for an extended period of time.

Approximate operating range of remote control

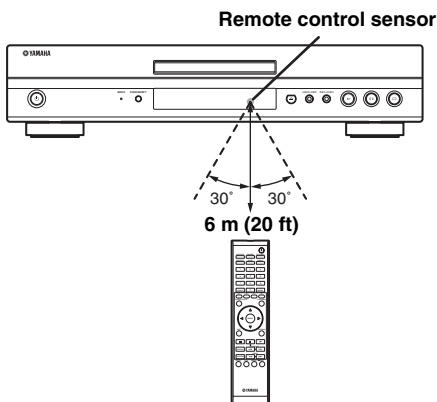

■ Turning the Power On

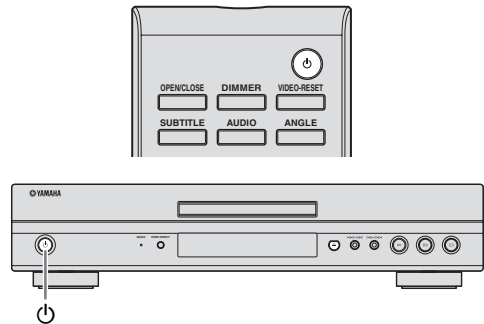

Turning the power on

Press on the remote control or on the Player to turn on the power of the Player.

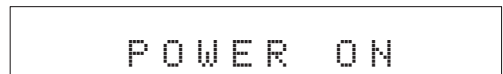

Entering standby

Press on the remote control or on the Player to enter standby.

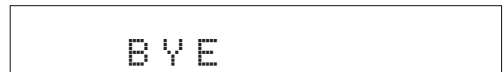

Note

- If you press again immediately after entering standby, the Player may not turn on. If this happens, wait for 10 seconds or more and then turn on the power again.

■ Indicators on the front panel display

indicator	Descriptions
BD	Lights up when playing back a BD disc.
DVD	Lights up when playing back a DVD-Video disc.
CD	Lights up when playing back a CD.
	Lights up when playing back.
	Lights up when pausing.
TITLE	Lights up when playing back a BD disc or DVD.
CHP/TRK	Lights up when playing back a BD disc, DVD, or CD.
REP S	Lights up when playing back track or chapter repeatedly.

indicator	Descriptions
REP ALL	Lights up when playing back disc or title repeatedly.
REP A-B	Lights up when playing back a section repeatedly.

Adjusting the brightness of the front panel display

If you feel that the front panel display is too bright when watching movies, you can adjust the brightness by pressing **DIMMER** repeatedly on the remote control.

Setting the on-screen display language

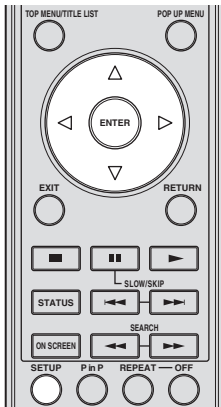

- ① Press **SETUP** to display the Setup Menu screen.



- ② Press $\Delta / \nabla / \triangleleft / \triangleright$ to select “On Screen Language”, then press **ENTER**.

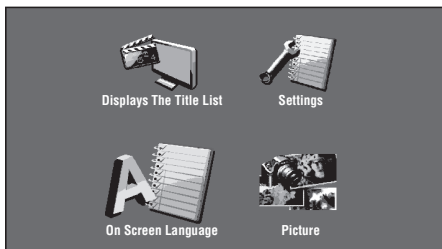

- ③ Press Δ / ∇ to select the language you want to display on the screen, then press **ENTER**.



Notes

- The language display in step 3 is an example for U.S.A., and Central and South America models.
- To select the DVD disc language, such as subtitle language, etc., see page 26.

Updating the software of this unit

Some of the newly released BD video discs cannot be played back unless you update this Player software to the latest version. We recommend updating the software of this unit with “Software Update” so that this Player is operated based on the latest software.

The USB memory device must be clear of all files except software update data to allow new software uploading.

To check for the availability of a software update, visit <http://www.yamaha.co.jp/english/product/av/down/agreement.html>.

When a software update is performed, the software update data must be written onto the USB memory device in advance using a PC. When software update data is released, copy the data onto a USB memory device after downloading it to a PC. Delete unneeded software update data using a PC after the software update process is completed.

- ① Insert the USB memory device with the update file into the USB BD STORAGE/SERVICE terminal on rear of this Player.
- ② Press **SETUP** to display the Setup Menu screen.
- ③ Press $\Delta / \nabla / \triangleleft / \triangleright$ to select “Settings”, then press **ENTER**.
- ④ Press Δ / ∇ to select “Software Update”, then **ENTER**.
 - If you have not yet set the password, go to step 6.
- ⑤ Enter the 4-digit number using 0-9.

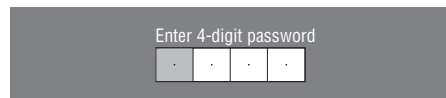

- ⑥ Press **ENTER** to start checking data in the USB memory device.



- ⑦ During the data checking, “Checking” blinks.

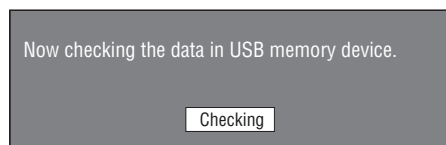

- The current version of this unit software and the version of the update file on the USB memory device are displayed. To update this Player software with update file, select “Yes”, and press **ENTER**.

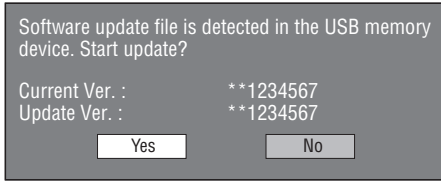

- If the USB memory device is not properly installed or the correct update file cannot be found on the USB memory device, an error message is displayed. Check the file on the USB memory device, and then reinsert the USB memory device correctly.

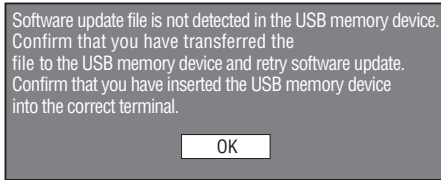

- Press **ENTER** to start updating.

- The screen becomes dark for a while until the update screen can be displayed. Please wait for the update screen to appear. Do not unplug the power cable.

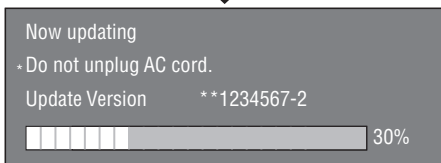
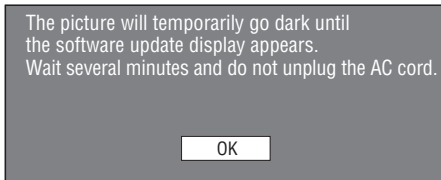

- When the software is successfully updated, a screen is displayed indicating that the update process is completed.

- If the update has failed, check the file in the USB device and try Software Update again.

- Press **⏻** to turn off the Player.

- Remove the USB memory device.

Hint

- You can clear the 4-digit number by pressing **CLEAR**.
- You can use **ENTER** on the lower right of the **Number** buttons instead of **ENTER** in the **Cursor** buttons.
- You can also update the software by inserting a CD-ROM with the update file.

Setting the audio output

To output audio correctly, set the audio output suited for your playback environment with “Audio Out”. Refer to “Common operations” and “Audio Out” on page 29 and 31.

Preparing for BD-LIVE

BD-LIVE is a new feature of Blu-ray Disc that allows you to download and enjoy movie trailers or bonus features by using the internet.

- Connect this player to the internet. (Page 14.)
- Insert a USB memory device (2GB or greater and formatted with FAT 32/16) supporting USB High Speed (480Mbit/s) to the USB BD STORAGE/SERVICE terminal on the back of this Player. (Page 14.)
- Prepare a BD-Video disc compatible with BD-LIVE. (“Enjoying BONUSVIEW or BD-LIVE” on page 24.)

Activating the Secondary Audio

When you set “Secondary Audio” in the “Setup Menu” to “On”, you can enjoy audio of the picture in picture or audio commentaries of BD-LIVE compatible Blu-ray discs. Refer to “Common operations” and “Secondary Audio” on page 29 and 31.

Controlling the Blu-ray disc player using the HDMI™ control function

Using the HDMI control function, you can interactively operate this Player with your TV (HDMI control function supported).

When you connect this Player to the TV compatible with the HDMI control function using an HDMI cable and set “HDMI Control” in the “Setup Menu” to “Yes”, you can perform the function listed below. (See page 9 and 33 for connecting to the HDMI terminal and “HDMI Control”.)

- **Automatic input select function**
When you start playback of this Player, the input selector of the TV (and an AV receiver if this Player is connected to the TV via the AV receiver) is switched to this Player automatically. TV Power may be turned on automatically depending on the TV.
- **Automatic power off function**
When you turn off the TV while this Player is in stop mode and the Setup Menu screen is not displayed, the power of this Player is also turned off automatically.

Notes

- HDMI control function may not work properly depending on the TV.
- Functions other than ones shown above may work depending on the TV or AV receiver.
- In order to make the HDMI control function available, set up settings for the HDMI control function on ALL the components (this Player, TV, and AV receiver). Certain operation may also be required.
- Each function may be set independently to activate/deactivate depending on the TV.
- Refer to the operation manuals supplied with the TV and/or AV receiver for details regarding setup.

BD/DVD/CD Playback

This section explains playback of commercially available BD Video and DVD Video discs (like movies), CDs, and recorded DVD-RW/R discs.

■ Loading a Disc

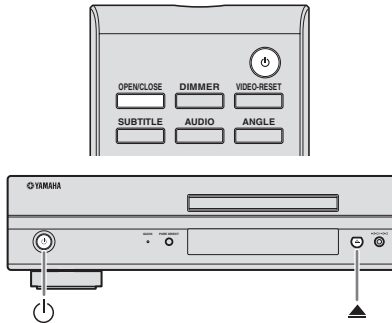

- ① Press to turn on the power.
- ② Press **OPEN/CLOSE** or to open the disc tray.
- ③ Load a disc on the disc tray.
 - Insert the disc with the label face up.
 - In case of disc recorded on both sides, face down the side to play back.

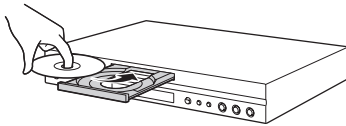

- ④ Press **OPEN/CLOSE** or to close the disc tray.

Notes

- Playback may begin automatically, depending on the disc.
- Playback begins from the first title.
- The menu may be displayed first, depending on the disc. Perform playback operation by following the directions on the screen.
- The disc load time may vary depending on the disc.

■ Basic playback operation

BD-V **BD-RE** **BD-R**
DVD-V **DVD-R** **DVD-RW** **AUDIO CD**

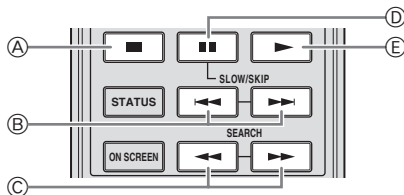

Buttons	Functions
(A)	Pauses or stops playback
(B)	Skips backward/Skips forward
(C)	Search backward/Search forward (search) *1
(D)	Pauses playback
(E)	Playback *2

*1 The search speed will change each time you press the button.

*2 The Player resumes playback from the point that where the Player was previously stopped. To playback from the beginning, press and then .

Notes

- This player supports DVD upscaling during DVD playback.
- Some of the newly released BD video discs cannot be played back unless you update this Player software to the latest version. Therefore, it may be required to update the software of this Player. Refer to page 37 for more information regarding software updates for this Player.

Frame Advance Playback

Frame Advance Playback functions when is pressed during Pause.

Notes

- Frame Advance Playback may not function properly with discs other than DVD-RW/R (VR format).
- Some BD/DVD Video discs are not compatible with Frame Advance Playback.
- Frame Advance/Reverse Playback can be performed for DVD discs by pressing or during pause.

Slow Playback

Slow Playback functions when or is pressed for more than 2 seconds during pause.

- Press to return to normal playback.

Notes

- This doesn't work for audio CDs.
- Reverse Slow Playback cannot be performed for BD video.

■ Enjoying pure hi-fi sound (Pure Direct function)

This Player is compatible with Pure Direct mode which enables you to enjoy analog signals output at the 2ch audio jacks and 8ch discrete audio jacks in pure high fidelity sound. When Pure Direct mode is activated, this Player plays back discs with the least circuitry.

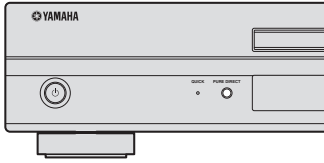

Press **PURE DIRECT** to turn the Pure Direct mode on or off.

- PURE DIRECT lights up when you set the Pure Direct mode on.

Hint

- The front panel display automatically turns off, and the analog video (component, S-video, and video) and the digital audio (optical and coaxial) are not output while this Player is in the Pure Direct mode.

■ Repeat Playback

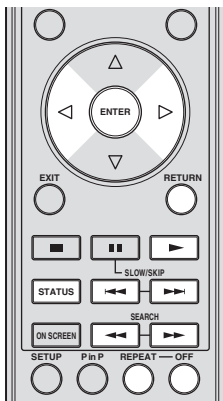

Repeat Playback of a Title or Chapter

- ① Play back the title or chapter you want to repeat.
- ② Press **REPEAT**.
- ③ Press $\triangleleft/\triangleright$ to select the type of Repeat Playback.
 - Playback Title: Repeats the title currently being played back.
 - Playback Chapter: Repeats the chapter currently being played back.
 - Scene Selection: Repeats the specified scene of title or chapter.

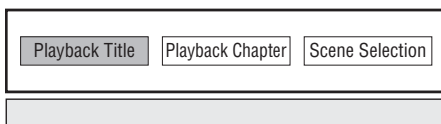

- Press **RETURN** to cancel without setting the type of Repeat Playback.
- For Audio CD, you can select “Playing Disc”, “Playing Track” and “Specify The Part” as Repeat Playback options.

- ④ Press **ENTER**.

Example: Repeat playback of a title (TITLE)

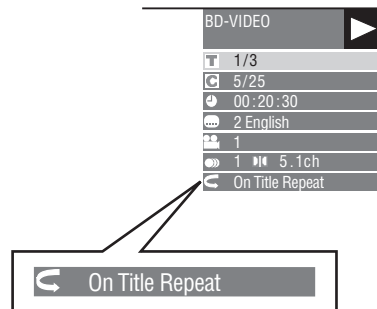

- ⑤ Press **OFF** to return to normal playback.

Repeat Playback of a Specified Part

DVD-V DVD-R DVD-RW
AUDIO CD

Note

- Some operations in the following playback function cannot be performed depending on the specifications of the disc.

- ① Press **REPEAT** during playback.
- ② Press $\triangleleft/\triangleright$ to select “Scene Selection”, then press **ENTER**.
 - “Set Start Point” displays.

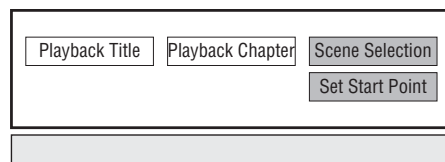

- ③ Press **ENTER** at the scene where you want to set the start point.
 - “Set End Point” displays.
- ④ Press **ENTER** at the scene where you want to set the end point.
 - You can press $\triangleright\triangleright$ to fast forward to the scene where you want to set the end point. When you reach the desired scene, simply press \triangleright and then **ENTER** to set the end point. To cancel Repeat Playback, press **OFF**.

Notes

- Press $\triangleright\triangleright$, the Repeat Playback is cancelled and the next chapter being play back.
- Press $\triangleleft\triangleleft$ once, the Repeat Playback is cancelled and the player returns to the start of current chapter (track).

- If you press **◀** again (within about 5 seconds) the player will skip to the beginning of the previous chapter (track).
- For Repeat Playback of a Specified Part, set the start and end points within the same title.
- Repeat Playback may be forbidden depending on the disc.
- Repeat Playback of a Specified Part may not work in multi-angle scenes.
- If you press **STATUS**, you can confirm the Repeat Playback status.

■ Using BD/DVD Menu

This section explains how to play back a BD/DVD video disc with a top menu, disc menu or pop-up menu. The titles listed in the top menu and a disc guide (for options like subtitles and audio languages) are given in the disc menu.

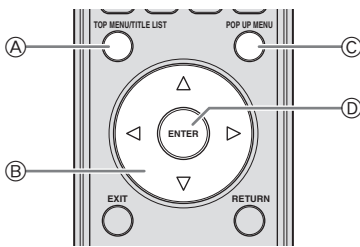

Buttons	Functions
Ⓐ TOP MENU/ TITLE LIST	Displays the top menu screen
Ⓑ $\Delta / \nabla / \triangleleft / \triangleright$	Moves the highlight in the menu screen
Ⓒ POP UP MENU	Displays the pop-up menu screen
Ⓓ ENTER	Selects the highlighted menu item

Notes

- The procedure explained on this page is the basic operation procedure. Procedures vary depending on the BD/DVD video disc, so you may need to follow the instructions in the BD/DVD video disc manual or the instructions displayed on the screen.
- With some BD/DVD discs, the top menu may be referred to as the "Title Menu". Use **TOP MENU/TITLE LIST** on the remote control when the instructions refer to "Title Menu".
- If no top menu is available, the **TOP MENU/TITLE LIST** button will have no effect.
- The top menu screen may be displayed by pressing **POP UP MENU** depending on the DVD.

Using the pop-up menu

BD-V

- ① Press **POP UP MENU** during playback.
 - The pop up menu screen is displayed.
 - The menu contents displayed vary depending on the disc. For details on how to see and operate the pop-up menu, refer to the manual for the disc.

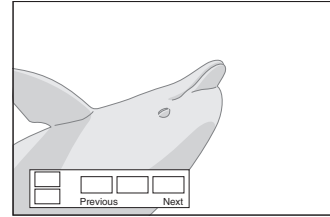

- ② Press $\Delta / \nabla / \triangleleft / \triangleright$ to select the desired item, then press **ENTER**.
- ③ Press **POP UP MENU** to exit.
 - The pop-up menu will automatically disappear for some discs.

■ Using DVD-R/-RW Menu

DVD-R DVD-RW

You can play back a recorded disc (VR format finalized disc only).

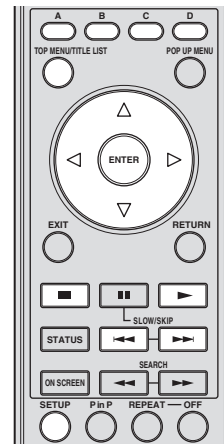

Note

- "Finalize" refers to a recorder processing a recorded disc so that it will play in other DVD players/recorders as well as this player. Only finalized DVD discs will play back in this player. (This player does not have a function to finalize discs.)

Playback by selecting a title

- Load a recorded disc.
 - The Title List screen is displayed.

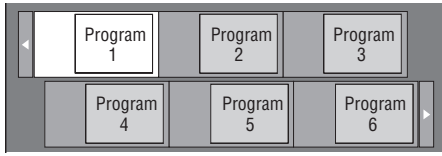

- If the Title List screen is not displayed, press **TOP MENU/TITLE LIST**.
- Press Δ / ∇ / \triangleleft / \triangleright to select the desired title, then press **ENTER**.
 - When seven or more titles exist, switch pages by pressing $\triangleleft\triangleleft$ or $\triangleright\triangleright$.
 - Playback of the selected title will begin. You can playback by pressing \blacktriangleright instead of pressing **ENTER**.
 - Press \blacksquare to stop playback.

Note

- The Title List screen also can be displayed by pressing **TOP MENU/TITLE LIST** when playback is stopped or by pressing **ENTER** after choosing “Displays The Title List” in Setup Menu when playback is stopped.

About Title List

- The Title List can be displayed in two types, Thumbnail and Title List.
- Each time you press **A**, the screen changes between Thumbnail and Title List.

Thumbnail

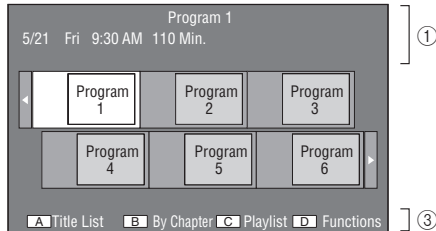

Title List

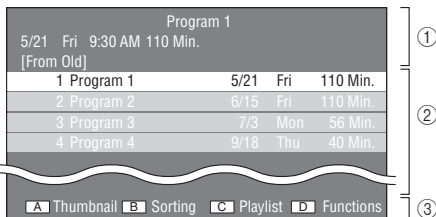

- Information of selected title
- Title Name
Recording Date
Recording Duration
- Caption for Color Button

Playback by selecting a chapter

- Press **B** while the Thumbnail screen is displayed.
 - The chapter screen is displayed.

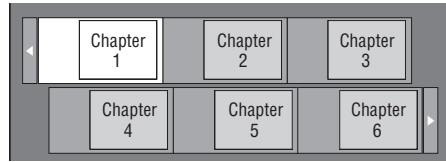

- When seven or more chapters exist, switch pages by pressing $\triangleleft\triangleleft$ or $\triangleright\triangleright$.
 - To return to the Thumbnail screen, press **B**.
- Press Δ / ∇ / \triangleleft / \triangleright to select the desired chapter, then press **ENTER**.
 - Playback of the selected chapter will begin. You can playback by pressing \blacktriangleright instead of pressing **ENTER**.
 - Press \blacksquare to stop playback.

Sorting the titles

Each time you press **B** while the Title List screen is displayed, the Title List display changes between displaying the newest title first and the oldest title first.

Playback by selecting a Playlist

- Press **C** while the Thumbnail or Title List screen is displayed.
 - The Playlist screen is displayed.

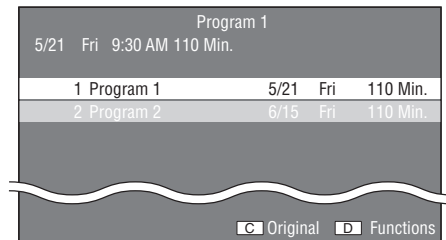

- Press Δ / ∇ to select the title, then press **ENTER**.
 - Playback of the selected title will begin.
- Press \blacksquare to stop playback.

Playing back the title you stopped while being played

- Press **D** while the Thumbnail or Title List screen is displayed.

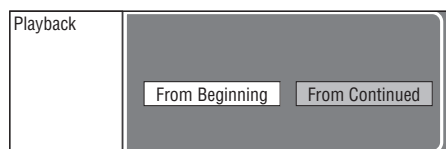

- Press \triangleleft / \triangleright to select the type of Playback, then press **ENTER**.
 - Playback of the title will begin.
- Press \blacksquare to stop playback.

■ Using the Audio CD Playback Menu

AUDIO CD

When you load an audio CD, following screen is displayed.

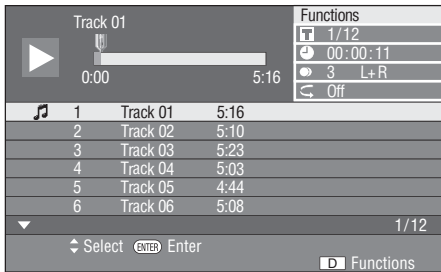

Note

- The CD screen is displayed only when a compact disc recorded in the CD-DA format is inserted.

Playback by selecting a track

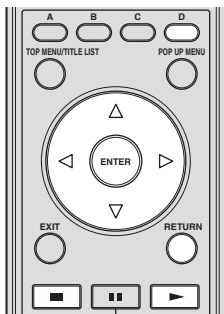

- Press Δ / ∇ to select the track, then press **ENTER** during playback or when playback is stopped.
 - Playback of the selected track will begin.

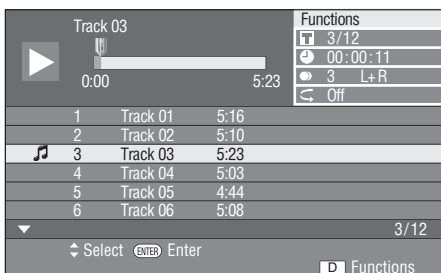

- Press \blacksquare once to pause playback (resume stop).
- To stop playback completely, press \blacksquare again.

Using the Function menu

- Press **D** when the CD screen is displayed.

- The “Functions” menu is activated.

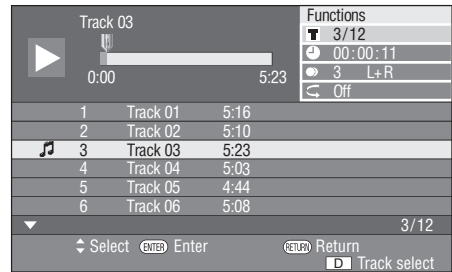

- Press Δ / ∇ to select the desired setting, then press **ENTER**.
 - When playback is stopped, only “Track” can be selected.
 - For a description of each setting, see “Functions which can be set” (page 26).
- Press Δ / ∇ / \triangleleft / \triangleright to set, then press **ENTER**.
 - Operations vary depending on the setting. Follow the operation instructions on the screen.
- Press **RETURN** or **D** to exit the “Functions” menu.

Note

- The displayed items vary depending on the disc.

■ Enjoying BONUSVIEW or BD-LIVE

BD-V

This Player is compatible with additional functions of BD-Video, BONUSVIEW (BD-ROM Profile 1 Version 1.1) and BD-LIVE.

For BD-Video discs compatible with BONUSVIEW, the functions of Picture in Picture and Virtual Package are available. For BD-LIVE compatible discs, you can enjoy a variety of functions via the internet in addition to the BONUSVIEW functions.

Virtual Package/BD-LIVE data is saved in Local Storage (USB memory device connected to this Player). To enjoy these functions, connect a USB memory device (2GB or greater and formatted with FAT 32/16) supporting USB 2.0 High Speed (480Mbit/s) to the USB BD STORAGE/SERVICE terminal (page 14) on the back of this player.

- If there is insufficient storage space, the data will not be copied/downloaded. Delete unneeded data or use a new USB memory device.
- If a USB memory device containing other data (previously recorded) is used, the video and audio may not play back properly.
- If the USB memory device is disconnected from this player during playback of Virtual Package/BD-LIVE data, playback of the disc will stop.
- Some time may be required for the data to load (read/write).
- Refer to “USB Memory Management” on page 36 for erasing the Virtual Package data and the BD-LIVE data in the USB memory device.

Notes

- Yamaha cannot guarantee that all brands' USB memory devices will operate with this player.
- Do not use a USB extension cable when connecting a USB memory device to the USB BD STORAGE/SERVICE terminal of the player. Using a USB extension cable may prevent the player from performing correctly.

Use of Picture in Picture function (secondary audio/video playback)

BD-Video that includes secondary audio and video compatible with Picture in Picture can be played back with secondary audio and video simultaneously as a small video in the corner.

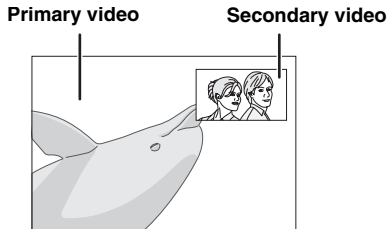

Press **P in P** to turn the Picture in Picture function on or off.

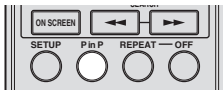
**Notes**

- To listen to secondary audio, make sure that "Secondary Audio" is set to "On". (See page 31.)
- The secondary audio and video for Picture In Picture may automatically play back and be removed depending on the content. Also, playable areas may be restricted.

Virtual Package

For BD-Video discs compatible with Virtual Package, data is copied from the discs or internet to local storage. It is automatically copied to the local storage prior to playback. You can enjoy a variety of additional functions including secondary video, secondary audio, subtitles, movie trailers, etc.

- The playback methods vary depending on the disc. For details, refer to the disc manual.

BD-LIVE

In this Player, a variety of contents with interactive functions are available through BD-LIVE compatible Blu-ray discs by connecting to the internet. You can enjoy the download of bonus features such as latest movie trailers to the USB memory device, communication compatible BD-J interactive games, etc.

- The available functions differ depending on the disc.

- The BD-LIVE operation methods and contents displayed vary depending on the programs provided through the internet. Operate by following the directions on the screen.

Notes

- Regarding playback method of BD-LIVE contents, etc., perform the operations in accordance with the instructions in the BD disc manual.
- To enjoy BD-LIVE functions, perform the broadband internet connection (page 14) and communication settings (pages 34–36).
- Refer to page 33 regarding the setup to restrict access to BD-LIVE contents.
- The time required to download the provided programs into the USB memory device connected to this player varies depending on the internet connection speeds and the data volume of the programs.
- BD-LIVE programs provided through the internet may not be able to display the connection depending on the status (updating) of the provider. In such cases, take out the disc and try again.
- If the BD-LIVE screen does not appear for a while after you select the BD-LIVE function in the BD disc menu, the USB memory device may not have enough free space. In such cases, eject the disc from the player, and then erase the data in the USB memory device using the Data Erase menu in the "USB Memory Management" menu. (See the operation manual on page 36.)

Function Control Screen

This allows you to adjust various settings at once, like subtitles, angle settings and the title selection for Direct Playback. You can adjust the video and audio to suit your preferences. The operations are the same for BD and DVD.

Function control screen

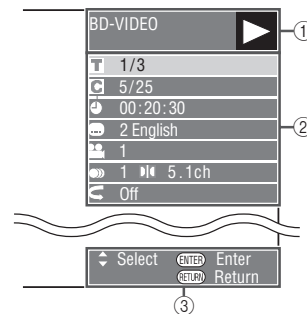

- ① **Playback status display**
Shows the operation status and the disc type.
- ② **Setting items**
Selects a title (or track) or chapter for playback, or performs video/audio settings.
- ③ **Operation guide display**
Provides help on remote control button operations.

Function control operation procedure

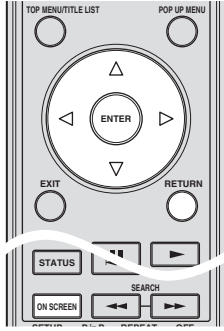

- ① Press **ON SCREEN** during playback.
 - The Function Control screen is displayed on the TV.
- ② Press Δ / ∇ to select the desired setting, then press **ENTER**.
 - For a description of each setting, see “Functions which can be set” (page 26).

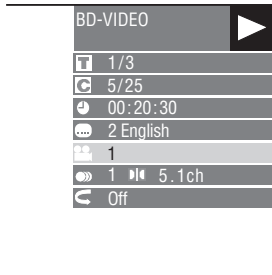

- ③ Press Δ / ∇ / \triangleleft / \triangleright to set, then press **ENTER**.
 - Operations vary depending on the setting. Follow the operation instructions on the screen.
- ④ Press **RETURN** or **ON SCREEN** to close the Function Control screen.



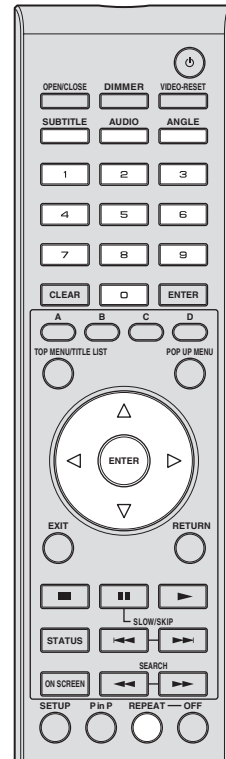

Notes

- If “–” is displayed for an option like title number or subtitles, the disc has no titles or subtitles which can be selected.
- The displayed items vary depending on the disc.
- If you access the Function Control screen during playback of a BD/DVD video, it may be impossible to operate the BD/DVD video playback. In cases like this, close the Function Control screen.

Functions which can be set



Icons	Functions	Descriptions
	Title/Track Number (Direct Title/Track Skip)	<ul style="list-style-type: none"> – Shows the title number being played back (or track number when playing back an audio CD). You can skip to the start of the title (or track). – To skip to the start of a selected title (or track), press the Number buttons to enter the title (or track) number when this option is highlighted.
	Chapter Number (Direct Chapter Skip)	<ul style="list-style-type: none"> – Shows the chapter number being played back. You can skip to the start of the chapter. – To skip to the start of a selected chapter, press the Number buttons to enter the chapter number when this option is highlighted.
	Playback Elapsed Time (Direct Time Skip)	<ul style="list-style-type: none"> – Shows the time elapsed from the beginning of the current disc title (or track). This lets you skip to a specific time. – Press \triangleleft / \triangleright to select the Hour, Minute or Second, then press Δ / ∇ or the Number buttons to set the time. Press ENTER to start playback at the set time.

Icons	Functions	Descriptions
	Subtitle Language	– Shows the currently selected subtitle language. If subtitles are provided in other languages, you can switch to your preferred language. You can also select the subtitle language by pressing SUBTITLE .
	Angle Number	– Shows the currently selected angle number. If the video is recorded with multiple angles, you can switch the angle. You can also switch the angle by pressing ANGLE .
 	Audio	– Shows the currently selected type of audio. You can select the desired type of audio. You can also select the type of audio by pressing AUDIO .
	Repeat	– The current Title (or Chapter) or partial segments can be repeatedly played back. Repeat Playback is also possible with the REPEAT button on the remote control.

Notes

- These functions may not work with all discs.
- For DVD-RW and DVD-R, when a recorded broadcast with stereo or monaural audio is played back, “Stereo” is displayed. (Audio cannot be switched.)
- When you play a program recorded in stereo or monaural, and if you are listening to the Bitstream sound via the digital output jack, you cannot select the audio channel. Set “Audio Out” to “PCM” (Page 31), or if you want to change the audio channel, listen via the analog output jacks.

■ Displaying the disc information

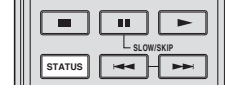

Press **STATUS** during playback.

- Each time you press **STATUS**, the display switches as follows.

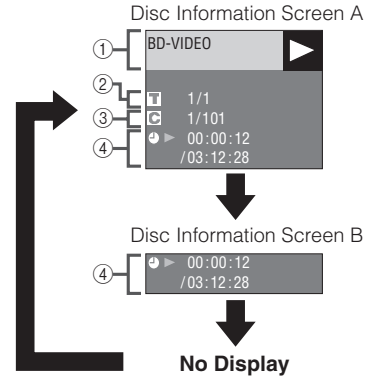

- ① Type of disc
- ② Title number being played / Total number of Titles
- ③ Chapter number being played / Total number of Chapters
- ④ Elapsed playback time / Total playback time for the Title

Notes

- Disc Information Screen A disappears after about 1 minute elapses without performing any operations.
- For some commercially-released BD VIDEO discs, the total playback time display for the Chapter/Title may not appear.

JPEG File Playback

CD-R
JPEG

CD-RW
JPEG

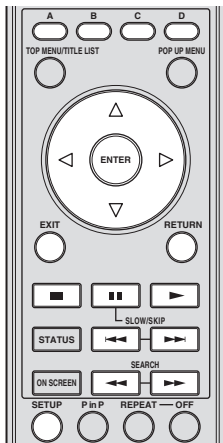

Notes

- This Player can play still images (JPEG files) that have been recorded on CD-RW/R discs. For details on the still images that you can play using this player, refer to "About the JPEG file format" on page 3.
- During "Normal play", still images are played one by one while during "Slide show", they are automatically replaced one after another.

■ Playing back still images in sequence

- Load the disc containing the still images, and press ►.
- The first still image appears on the screen.
 - Press ◀◀ or ▶▶ to proceed to the next or previous still image.
 - The same operation can be performed by pressing ◀/▶ or ◀◀ or ▶▶.

■ Playing back still images in a selected folder

- ① Load the disc containing still images, then press **SETUP**.
- ② Press $\Delta / \nabla / \triangleleft / \triangleright$ to select "Picture", then press **ENTER**.
- ③ Use $\Delta / \nabla / \triangleleft / \triangleright$ to select the folder whose still images are to be played, then press **ENTER**.

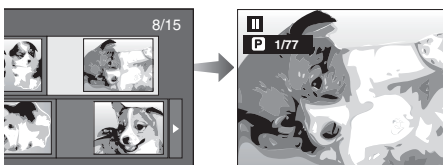

- ④ Press ◀◀ or ▶▶ to replace one image with another.
 - The same operation can be performed by pressing ◀/▶ or ◀◀ or ▶▶.
 - Press **RETURN** if you wish to return to the folder selection screen.
- ⑤ To stop the still image playback at any time, press ■.

■ Playing back Slide Show

- ① In Step 2 of the left side "Playing back still images in a selected folder", press ► (Slide Show).
 - The still images inside the selected folder are played as a slide show.
 - ② To pause the playback at any time, press ■■.
 - ③ To stop the play at any time, press ■.
- Press ► to resume playback.
 - Press **RETURN** to play a slide show of still images in another folder.

■ Setting slide show speed/repeat playback

- ① Press **C** (Slide Show Menu) during the folder selection screen.
 - The setting screen for "Slide Show Speed"/"Repeat Mode Setting" appears.
- ② Press Δ / ∇ to select "Slide Show Speed", then press **ENTER**.



- ③ Press Δ / ∇ to select the desired speed, then press **ENTER**.
 - The slide show speed may be selected from "Fast", "Normal", "Slow1" and "Slow2".
- ④ Press Δ / ∇ to select "Repeat Mode Setting", then press **ENTER**.

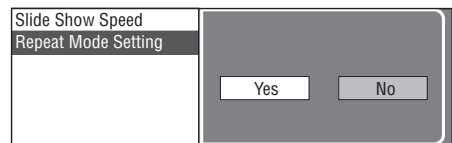

- ⑤ Press ◀/▶ to select the desired item, then press **ENTER**.
- ⑥ Press **EXIT** to exit.

Settings

The “Menu” enables various audio/visual settings and adjustments on the functions using the remote control unit.

Menu/Submenu	Function	Page	
Audio Video Settings	TV Aspect Ratio	Sets the screen aspect ratio of the connected TV, and adjust the video output.	30
	Component Video Out	Sets the resolution of the component video output.	30
	HDMI Video Out	Sets the resolution of the HDMI video output.	31
	Video Out Select	Selects the priority of the video output.	31
	Secondary Audio	Sets the audio of the picture in picture or audio commentaries.	31
	Audio Out	Sets the audio output suited for your playback environment.	31
	Dynamic Range Control	Adjusts the dynamic range for playback at average volume.	32
Speaker Settings		Sets the speakers connected to this Player via the 8ch discrete jacks.	32
Quick Start		Sets the startup time of this Player to be reduced.	33
Auto Power Off		Sets the power of this Player to be turned off automatically.	33
HDMI Control		Sets this Player to receive the control signal from the remote control of your TV.	33
Playback Setting	Parental Control	Sets the Parental Control depending on the disc content.	33
	Disc Language	Selects the language for subtitles, audio, and menus displayed on the screen.	33
	Angle Mark Display	Sets to display the Angle Mark when BD/DVD with multiple angles is played back.	33
	Password Setting	Sets the password.	33
	BD Internet Access	Sets access restriction to BD-LIVE contents.	33
Communication Setup		Changes the communication settings.	34
Version		Displays the system software version.	34
USB Memory Management		Deletes data in a USB memory.	36
Software Update		Updates the software of this Player.	17, 37
System Reset		Resets all settings to the factory presets.	34

Common operations

You need to call up the Setup Menu screen to perform settings for this player. The following is the explanation for the basic operations of the “Menu”.

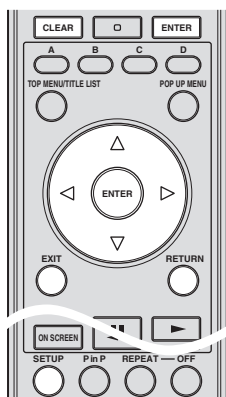

Example: Setting “Auto Power Off”

1. Display the Menu screen

Press **SETUP** to display the Setup Menu screen. Press Δ / ∇ / \triangleleft / \triangleright to select “Settings”, then press **ENTER**.

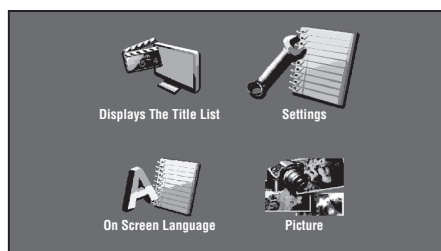

2. Select a menu item

Press Δ / ∇ to select “Auto Power Off”, then press **ENTER**.

Audio Video Settings
Speaker Settings
Quick Start
Auto Power Off
HDMI Control
Playback Setting
Communication Setup
Version
USB Memory Management
Software Update
System Reset

3. Select the next item

Press $\triangleleft/\triangleright$ to select the desired item, then press **ENTER**.



Press **RETURN** to return to the previous “Menu” page.

4. Exit the Menu screen

Press **SETUP** or **EXIT** to exit.

Example of the Setup Menu operation

Example: Setting “Parental Control” under “Playback Setting”

- ① Press **SETUP** to display the Setup Menu screen.
- ② Press $\triangle/\nabla/\triangleleft/\triangleright$ to select “Settings”, then press **ENTER**.
- ③ Press \triangle/∇ to select “Playback Setting”, then press **ENTER**.
- ④ Press \triangle/∇ to select “Parental Control”, then press **ENTER**.
 - When you operate this Player for the first time, the password setting screen will be displayed. See “When setting the password for the first time” below.
- ⑤ Enter your 4-digit password.
 - You cannot move to the next setting screen until you can input the correct password.

When setting the password for the first time.

1. To set the password for the first time, press $\triangleleft/\triangleright$ to select “Yes” to enter the password setting menu, then press **ENTER**.
2. Enter a 4-digit number for the password, then the same 4-digit number for confirmation.
3. Press **ENTER** to complete the password setting procedure and move to the next setting screen.

Hints

- You can clear the 4-digit number by pressing **CLEAR**.

- You can use **ENTER** on the lower right of the **Number** buttons instead of **ENTER** in the **Cursor** buttons.

- ⑥ Press $\triangleleft/\triangleright$ to select the parental control level for DVD VIDEO, BD-ROM, and then select the country code. Press **ENTER** after making each selection.

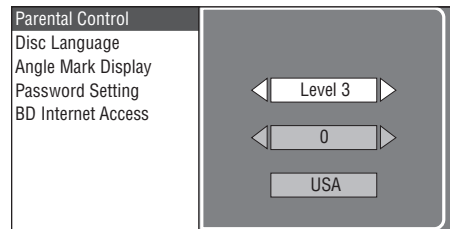

- ⑦ Press **SETUP** or **EXIT** to exit.

Audio Video Settings

Hint

- The default settings are marked with “*”.

TV Aspect Ratio

You can set the screen aspect ratio of the connected TV, and adjust the video output.

If you switch your TV (i.e. because you have bought a new one) and the screen aspect ratio of the connected TV changes, you will have to change the “TV Aspect Ratio” setting.

Wide 16:9*: Select this when connecting to a TV with a 16:9 screen aspect ratio.

Normal 4:3: Select this when connecting to a TV with a 4:3 screen aspect ratio.

When selecting Normal 4:3

Letter Box*: If you playback a DVD with 16:9 video, the video will be played back with black bands at the top and bottom while maintaining the 16:9 ratio.

Pan Scan: If you playback a DVD with 16:9 video, the video will be played back with the left and right sides of the image cut off to display in 4:3 screen aspect ratio. (This function works if the disc is labelled for 4:3PS.)

Component Video Out

This sets the resolution of the component video output. Some TV are not fully compatible with the Blu-ray disc player, which may cause the image distortion. In this case, press **VIDEO-RESET** on the remote control for five seconds. “Component Video Out” will be reset to “480i” (factory preset value).

1080i, 720p, 480p, 480i*

Note

- Some discs prohibit high definition video output from the COMPONENT jacks. In this case, the video resolution is converted to 480p or 480i.

HDMI Video Out

This sets the resolution of the HDMI video output. Some TV are not fully compatible with the Blu-ray disc player, which may cause the image distortion. In this case, press **VIDEO-RESET** on the remote control for five seconds. "HDMI Video Out" will be reset to "Auto" (factory preset value).

Auto*, 1080p, 1080i, 720p, 480p

Note

- When the BD player is connected to a 1080p/24Hz compatible TV and the "HDMI Video Out" is set to "Auto", 1080p/24Hz will automatically be displayed when compatible discs are played back. At 1080p/24Hz or 1080p/60Hz, there is no output from the COMPONENT jacks and VIDEO jack.

Video Out Select

Dual video output is possible simultaneously from the analog video jacks (component, S-video, and video) and the HDMI terminal with the following settings. Select the video output which you want to have priority according to the following chart.

HDMI*: Select this to give priority to HDMI output. You can set the resolution of the HDMI video output in "Settings" - "Audio Video Settings" - "HDMI Video Out". (See page 31.)

Component: Select this to give priority to analog (component, S-video, and video) output. You can set the resolution of the component video output in "Settings" - "Audio Video Settings" - "Component Video Out". (See page 30.)

Notes

- 1080p is only available in HDMI.

Settings on this Player		Output Resolution	
Video Out Select	HDMI Video Out	Component Out	S/CVBS Out
HDMI	Auto	*1 *2	480i *3
	1080p	No Output	No Output
	1080i	1080i *1	480i
	720p	720p *1	480i
	480p	480p *1	480i

Settings on this Player		Output Resolution	
Video Out Select	Component Video Out	HDMI Out	S/CVBS Out
Component	1080i *1	1080i *1	480i
	720p *1	720p *1	480i
	480p	480p	480i
	480i	480i	480i



*1 Some discs prohibit high definition video output from COMPONENT jacks. In this case, video resolution is converted to 480p (when "Video Out Select" is set to "Component") or 480i (when "Video Out Select" is set to "HDMI").

*2 Depends on the TV connected. No video output when 1080p signal is output from the HDMI terminal.

*3 No video output when 1080p signal is output from the HDMI terminal.

- If the video equipment connected to each of the terminals is not compatible with the resolution of the priority video output, abnormalities in images on the screen may appear.

Hint

- This function can also be performed by the front panel buttons. Press and hold  and  on the front panel (or press and hold **DIMMER** on the remote control) for more than 4 seconds while no disc is inserted in this Player and the disc tray is closed.

Secondary Audio

You can turn on and off the audio of the picture in picture or audio commentaries.

- Select "On" to output the audio of the picture in picture.
- Select "Off" to enjoy the high-quality sounds of BD-Video.

Hint

- When you set "Secondary Audio" to "Off", this unit does not output the clicking sound on the menu.

On, Off*

Audio Out

You can set the audio output suited for your playback environment.

- Select the audio output connected to a TV or AV receiver.

HDMI Output*: Select this when you connect using HDMI terminal.

Digital Output: Select this when you connect using DIGITAL OUT terminal (COAXIAL/OPTICAL).

7.1ch Audio Output: Select this when you connect using AUDIO OUT (8ch discrete) jacks.

2ch Audio Output: Select this when you do not use SURROUND sound equipment.

- Select the output mode.

When you selected "HDMI Output"

Bitstream*:

- Select this when connecting to HDMI equipment with a built-in decoder for DOLBY DIGITAL, etc.
- Setting to Bitstream will output each audio signal by Bitstream.

PCM (Surround):

- Select this when connecting to multi-channel HDMI equipment (without a built-in decoder for DOLBY DIGITAL, etc.) or 2ch HDMI equipment such as TV.
- Setting to PCM (Surround) will output by LINEAR PCM by decoding audio signals recorded in each audio output mode such as DOLBY DIGITAL, DTS.

Note

- When “Secondary Audio” is set to “On”, PCM is automatically selected as the audio output mode.

When you selected “Digital Output”

- Bitstream*:**
- Select this when connecting to SURROUND equipment with a built-in decoder for DOLBY DIGITAL, etc.
 - Setting to Bitstream will output each audio signal by Bitstream.
- PCM:**
- Select this when connecting to 2 channel stereo audio equipment.
 - Setting to PCM will output by converting each audio signal into PCM 2 channel audio signal.

Note

- See page 38 for information on the audio output formats.

Dynamic Range Control

This lets you adjust the range between the loudest and softest sounds (dynamic range) for playback at average volume. Use this when it is hard to hear dialog.

- Normal:** The same audio output range is played as the original recorded audio output range.
- Shift:** When Dolby Digital audio is played back, the dynamic range of the audio is adjusted so that the dialog portion can be heard easily. (If the audio sounds abnormal, set to “Normal”.)
- Auto*:** When you play back audio in the Dolby TrueHD format, the dynamic range is automatically adjusted.

* Lower the audio volume before setting. If you do not do so, the speakers may emit a loud sound or excessive output may be applied to the speakers.

Speaker Settings

This sets size, distance, and volume levels for individual speakers when you connect using AUDIO OUT (8ch discrete) jacks.

- ① Press **SETUP** to display the Setup Menu screen.
- ② Press $\triangle / \nabla / \triangleleft / \triangleright$ to select “Settings”, then press **ENTER**.
- ③ Press \triangle / ∇ to select “Speaker Settings”, then press **ENTER**.
- ④ Press $\triangleleft / \triangleright$ to select “Yes”, then press **ENTER**.
 - Select “No” to cancel without configuring the Speaker Settings.

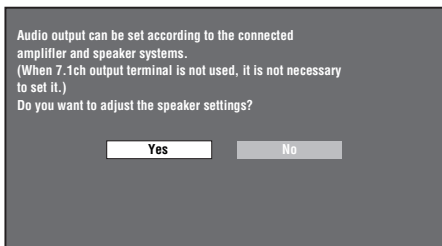

- ⑤ Press $\triangle / \nabla / \triangleleft / \triangleright$ to select a speaker you want to configure, then press **ENTER**.

L (Front Left), **C** (Center), **R** (Front Right), **RS** (Surround Right), **RB** (Surround Back Right), **LB** (Surround Back Left), **LS** (Surround Left), **SW** (Subwoofer)

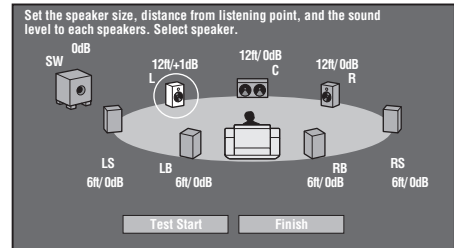

- ⑥ Press $\triangleleft / \triangleright$ to select “Size”, “Distance”, and “Level”, then press \triangle / ∇ to set the value for the selected item.

- Size:** You can set the sizes from “Small”, “Large*”, and “No”.
- Distance:** You can set the distances from “0.3m (1 ft)” - “3.0m (10 ft)*” - “9m (29 ft)”.
- Level:** You can set the volume levels from “-12 dB” - “0 dB*”.

Notes

- When “SW” is set to “No”, the speakers cannot be set to “Small”.

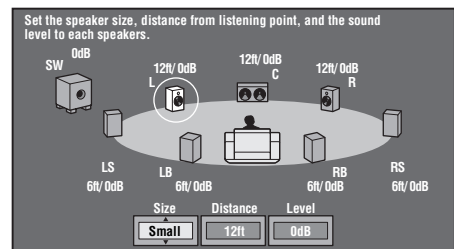

- To set the other items, repeat step 6.
 - To set the other speakers, repeat step 5 - 6.
- ⑦ Press ∇ to select “Test Start”, then press **ENTER**.
The test tone is output from each speaker to help you judge the volume levels.
 - ⑧ Press ∇ to select “Test Tone Stop”, then press **ENTER**.
The test tone stops.
 - ⑨ Press \triangleright to select “Finish”, then press **ENTER**.

■ Quick Start

This turns the Quick Start function on and off.

When the Quick Start function is on:

- The startup time of the Player is reduced.
- However, power consumption will increase.
- The QUICK indicator lights up.

When the Quick Start function is off:

- The player will enter the low power consumption mode when in standby condition.

Yes, No*

Note

- When “Quick Start” is set to “Yes”, the Player requires some time to turn off.

■ Auto Power Off

This sets the Player so that power is automatically shut off if playback is stopped for about 10 minutes.

Yes, No*

■ HDMI Control

This lets you set the Player to receive the control signal from the remote control of the TV compatible with the HDMI control function via the HDMI cable.

Yes, No*

Notes

- For details, refer to “Controlling the Blu-ray disc player using the HDMI control function” (page 18) and the operation manual of AV receiver and TV.
- If “Component” is selected in “Video Out Select”, HDMI Control function is not available. Select “HDMI” if you want to use HDMI Control features.

■ Playback Setting

Parental Control

In some digital broadcasts and BD/DVD video discs, a control level for disc viewing is set depending on the age of the viewer. This lets you set the Parental Control depending on the disc content. The available Parental Control Levels are shown below.

The 4-digit password number needs to be entered before the Parental Control Levels and the Country Code are set. The Parental Control Levels and the Country Code cannot be set if a password has not been created or the password is not entered.

For DVD-VIDEO

- 8 and Off*:** All DVD-video can be played.
- 1-7:** Prohibits play of DVD-video with corresponding ratings recorded on them.

For BD-ROM

- No Limit*:** All BD-video can be played.
- 0-99 year(s):** Prohibits play of BD-video with corresponding ratings recorded on them.

Country code

Sets the country code. Refer to the Country Code List (page 38) because the ratings differ according to the country.

Note

- Refer to “Example of the Setup Menu operation” on page 30 for details.

Disc Language

This lets you select the language for subtitles, audio and menus displayed on the screen.

Subtitle

Refer to the Language List. (page 38)

Audio

Refer to the Language List. (page 38)

Menu

Refer to the Language List and Language Code List. (page 38)

Angle Mark Display

This lets you turn the Angle Mark Display on or off when BD/DVD video recorded with multiple angles is played back. (The Angle Mark is displayed in the lower right screen.)

Yes, No*

Password Setting

This sets the password for setting or changing the Parental Control Level.

- Yes:** Enter the 4-digit number.
- No:** Cancels the password setting.

Notes

- When you forget the password, you can reset the current password using “System Reset” under “Settings”. (page 34)
- You can also set the new password if desired.

BD Internet Access

This allows you to set access restriction to BD-LIVE contents.

- Permit:** Allow all BD-LIVE discs.
- Limit*:** Allow only discs with owner certification.
- Prohibit:** Prohibit all BD-LIVE discs.

Notes

- The available functions differ depending on the disc.
- Regarding playback method of BD-LIVE contents, etc., perform the operations in accordance with the instructions in the BD disc manual.
- To enjoy BD-LIVE functions, perform the broadband internet connection (page 14) and communication settings (pages 34–36).

Version

When you select “Version”, the system software version is displayed.

System Reset

You can reset all settings to the factory presets.

Reset, Not Reset

Communication Setup

This allows you to perform and/or change the communication setting. This setting is required to use BD-LIVE functions that connect to the internet.

Notes

- Make sure that the LAN cable is connected to this Player. (See page 14.)
- For manually performing the setting, the following information of the connected router or modem is required. Confirm the information prior to the setting.
 - IP address, netmask, gateway, DNS IP address
- Besides, if specifying a proxy server, the following information specified from your internet service provider is also required. Confirm the information prior to the setting.
 - IP address and port number of the proxy server

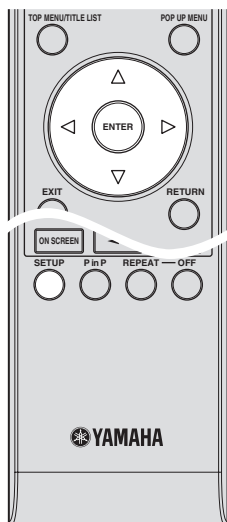

- ① Press **SETUP** to display the Setup Menu screen.
- ② Press $\Delta / \nabla / \triangleleft / \triangleright$ to select “Settings”, then press **ENTER**.
- ③ Press Δ / ∇ to select “Communication Setup”, then press **ENTER**.
- ④ Select “Ethernet Setup (BD-LIVE)”, then press **ENTER**.

- ⑤ Press $\triangleleft / \triangleright$ to select “Change”, then press **ENTER**.

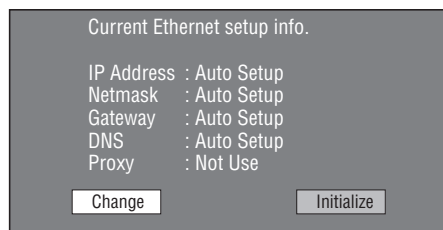

- For initializing the current setting, select “Initialize”, then press **ENTER**.

- ⑥ For setting the IP address, press $\triangleleft / \triangleright$ to select “Yes” or “No”, then press **ENTER**.

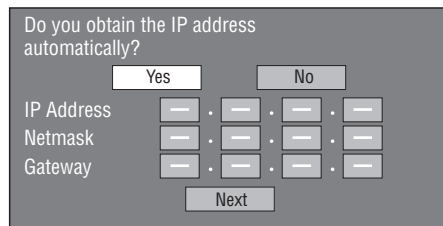

- If selecting “Yes”: The IP address is automatically obtained.
- If selecting “No”: The IP address, netmask and gateway are manually entered using the screen for inputting characters. (See page 36.)
Regarding each of the setup values, confirm the specifications of your broadband router.

- ⑦ Select “Next”, then press **ENTER**.
- ⑧ For setting the DNS IP address, enter the primary and secondary IP addresses using the screen for inputting characters. (See page 36.)
Regarding each of the setup values, confirm the specifications of your broadband router.
- ⑨ Select “Next”, then press **ENTER**.
- ⑩ For setting the proxy server, press $\triangleleft / \triangleright$ to select “Yes” or “No”, then press **ENTER**.

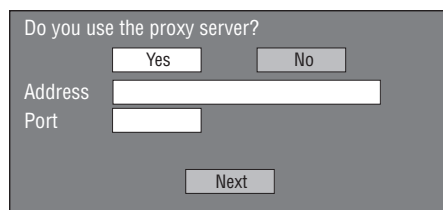

- If selecting “Yes”: The IP address or proxy server name and port number for the proxy server specified from your internet service provider are entered using the screen for inputting characters. (See page 36.)
- If selecting “No”: Go to the next step.

- ⑪ Select “Next”, then press **ENTER**.
- ⑫ For the advanced setting (the setting of the Ethernet connection speeds), press $\triangleleft / \triangleright$ to select “Yes” or “No”, then press **ENTER**.
 - Normally select “No”, then press **ENTER**.

- The Ethernet connection speeds can be set when you select “Yes”, then press **ENTER**.
- As automatic detection is made (factory preset mode), this setting is not normally necessary. If a situation occurs in which the Ethernet connection fails, etc., change the setting and confirm if the Ethernet connection successfully works. When the connection speed is set, select “Next”, then press **ENTER**.

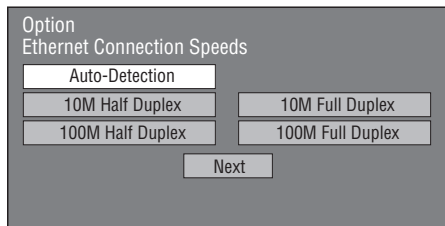

- ⑬ For testing the connection to the internet, after confirming the settings, press \triangle/∇ to select “Test”, then press **ENTER**.

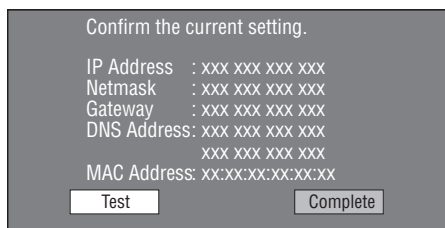

- As a result of the test, if the internet connection fails, enter the setup values manually.

- ⑭ Press \triangle/∇ to select “Complete”, then press **ENTER**.

The operation procedure for inputting characters manually

Note

- Numeric characters such as IP address can be entered on the input screen either by selecting each of the characters in the “Numeric” mode or using the **Number** buttons on the remote control.

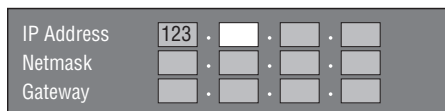

- ① Press **ENTER** at the boxes in which characters are to be entered, and the input screen will appear.

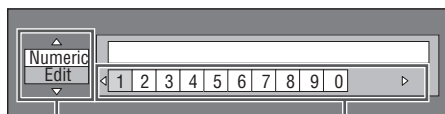

Selected by pressing \triangle/∇ Selected by pressing \triangle/∇

- ② Press \triangle/∇ to select the desired input mode.
- When inputting the address of the proxy server; “1ABC” (Alphabet/numeric character) / “Sign” / “Edit”

- When inputting other values (IP address, etc.); “Numeric” / “Edit”

- ③ Press \triangle/∇ to select a number/character, then press **ENTER**.

- ④ Repeat step 3 to display all of the desired characters/numbers in the input field.

Example: The screen for inputting numeric characters

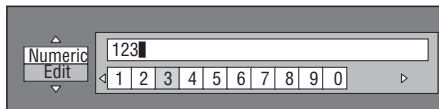

Note

- Press **RETURN** (Del.Char.) to delete a number/character you have input. To change a number/character you have input, press **B** (Left) or **C** (Right) to select the number/character you want to change, and press **RETURN** (Del.Char.). Then, press \triangle/∇ to select a new number/character you want to input, and press **ENTER**.

- ⑤ Press **D** (Complete) to fix the numbers which have been input.

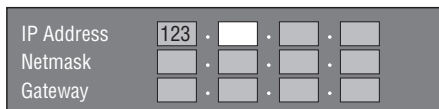

- ⑥ Repeat step 1 to 5 to finish inputting all the required characters.

Input character list

1ABC (Alphabet/ numeric character)	Num.	ABC	DEF	GHI	JKL
	MON	PQRS	TUV	WXYZ	Sp.
	Num.	1 2 3 4 5 6 7 8 9 0			
	ABC	A B C a b c			
	DEF	D E F d e f			
	GHI	G H I g h i			
	JKL	J K L j k l			
	MNO	M N O m n o			
	PQRS	P Q R S p q r s			
	TUV	T U V t u v			
WXYZ	W X Y Z w x y z				
Sp.	(space)				
Numeric	1 2 3 4 5 6 7 8 9 0				
Sign	@ . , : ; _ - \ \$ % ! ? & # + * = / ~				
	“ ” ^ ^ () < > [] { } Sp.				
	@ . , :	@ . , :			
	; _ - \	; _ - \			
	\$ % ! ?	\$ % ! ?			
	& # + *	& # + *			
	= / ~	= / ~			
	“ ” ^ ^	“ ” ^ ^			
	() < >	() < >			
	[] { }	[] { }			
Sp.	(space)				
Edit	Cancel	Left	Right		
	Complete	Del.Char			
	* The same operation as the colored buttons and RETURN can be performed by selecting each of the items and pressing ENTER .“Del.Char.” stands for deleting characters.				

Before using the USB memory device

CAUTION:

- Do not remove the USB memory device or unplug the power cable while the operations for “USB Memory Management” or “Software Update” are being performed.
- Do not use a USB extension cable when connecting a USB memory device to the USB BD STORAGE/SERVICE terminal of the Player. Using a USB extension cable may prevent the Player from performing correctly.

Note

- Yamaha cannot guarantee that all brands’ USB memory devices will operate with this Player.

■ USB Memory Management

The following instructions explain how to delete data such as the Virtual Package data and the BD-LIVE data in a USB memory device.

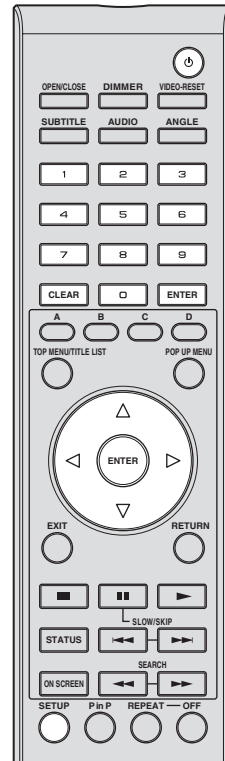

- ① Insert the USB memory device into the USB BD STORAGE/SERVICE terminal on rear of this Player.
- ② Press **SETUP** to display the Setup Menu screen.
- ③ Press $\Delta / \nabla / \triangleleft / \triangleright$ to select “Settings”, then press **ENTER**.
- ④ Press Δ / ∇ to select “USB Memory Management”, then press **ENTER**.
 - “No USB Memory” appears when no USB memory is inserted.
- ⑤ Press Δ / ∇ , select “Erase” or “Format”, then press **ENTER**.

Erase: Deletes only BD-VIDEO data written on the USB memory device such as BD-LIVE data.
Format: Be aware that all data including BD-VIDEO data and software update data will be deleted.
 If you want to delete only the unneeded software update data after the software is updated, delete the data on the USB memory device using a PC.

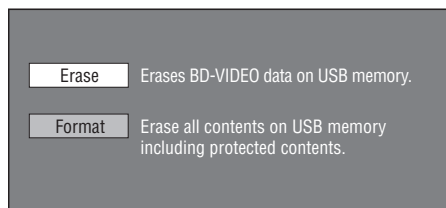
**Note**

- Data which has been saved to the Player's internal memory (game score, etc.) will also be deleted.

⑥ Press $\triangleleft/\triangleright$, select "Yes", and press **ENTER**.



⑦ Start the process.
– The screen for the current operation will display.



⑧ Press **ENTER**.

■ Software Update

This function allows software updates by inserting a USB memory device with the update file into the USB BD STORAGE/SERVICE terminal on this Player. Refer to page 17 for details.

Country Code List

USA / CANADA / JAPAN / GERMANY / FRANCE / UK / ITALY / SPAIN / SWISS / SWEDEN / HOLLAND / NORWAY / DENMARK / FINLAND / BELGIUM / HONG KONG / SINGAPORE / THAILAND / MALAYSIA / INDONESIA / TAIWAN / PHILIPPINE / AUSTRALIA / RUSSIA / CHINA

Language List

English / Français / Deutsch / Italiano / Español / Japanese / Svenska / Nederlands

Language Code List

AA Afar / **AB** Abkhazian / **AF** Afrikaans / **AM** Ameharic / **AR** Arabic / **AS** Assamese / **AY** Aymara / **AZ** Azerbaijani / **BA** Bashkir / **BE** Byelorussian / **BG** Bulgarian / **BH** Bihari / **BI** Bislama / **BN** Bengali, Bangla / **BO** Tibetan / **BR** Breton / **CA** Catalan / **CO** Corsican / **CS** Czech / **CY** Welsh / **DA** Danish / **DE** German / **DZ** Bhutani / **EL** Greek / **EN** English / **EO** Esperanto / **ES** Spanish / **ET** Estonian / **EU** Basque / **FA** Persian / **FI** Finnish / **FJ** Fiji / **FO** Faroese / **FR** French / **FY** Frisian / **GA** Irish / **GD** Scots Gaelic / **GL** Galician / **GN** Guarani / **GU** Gujarati / **HA** Hausa / **HI** Hindi / **HR** Croatian / **HU** Hungarian / **HY** Armenian / **IA** Interlingua / **IE** Interlingue / **IK** Inupiak / **IN** Indonesian / **IS** Icelandic / **IT** Italian / **IW** Hebrew / **JA** Japanese / **JI** Yiddish / **JW** Javanese / **KA** Georgian / **KK** Kazakh / **KL** Greenlandic / **KM** Cambodian / **KN** Kannada / **KO** Korean / **KS** Kashmiri / **KU** Kurdish / **KY** Kirghiz / **LA** Latin / **LN** Lingala / **LO** Laothian / **LT** Lithuanian / **LV** Latvian, Lettish / **MG** Malagasy / **MI** Maori / **MK** Macedonian / **ML** Malayalam / **MN** Mongolian / **MO** Moldavian / **MR** Marathi / **MS** Malay / **MT** Maltese / **MY** Burmese / **NA** Nauru / **NE** Nepali / **NL** Dutch / **NO** Norwegian / **OC** Occitan / **OM** Afan (Oromo) / **OR** Oriya / **PA** Panjabi / **PL** Polish / **PS** Pashto, Pushto / **PT** Portuguese / **QU** Quechua / **RM** Rhaeto-Romance / **RN** Kirundi / **RO** Romanian / **RU** Russian / **RW** Kinyarwanda / **SA** Sanskrit / **SD** Sindhi / **SG** Sangho / **SH** Serbo-Croatian / **SI** Singhalese / **SK** Slovak / **SL** Slovenian / **SM** Samoan / **SN** Shona / **SO** Somali / **SQ** Albanian / **SR** Serbian / **SS** Siswat / **ST** Sesotho / **SU** Sundanese / **SV** Swedish / **SW** Swahili / **TA** Tamil / **TE** Telugu / **TG** Tajik / **TH** Thai / **TI** Tigrinya / **TK** Turkmen / **TL** Tagalog / **TN** Setswana / **TO** Tonga / **TR** Turkish / **TS** Tsonga / **TT** Tatar / **TW** Twi / **UK** Ukrainian / **UR** Urdu / **UZ** Uzbek / **VI** Vietnamese / **VO** Volapuk / **WO** Wolof / **XH** Xhosa / **YO** Yoruba / **ZH** Chinese / **ZU** Zulu

About the audio output formats

Settings on this Player			Audio Output Format from Each Audio Terminals			
Audio Out	Secondary Audio	Output format (Audio Out)	HDMI Out	Optical/Coaxial Out	8ch discrete out	2ch mixed out
HDMI Output	On	Bitstream	Cannot select this mode			
		PCM	Max 7.1ch PCM (48KHz) *1	2ch PCM (48KHz)	2ch	2ch
	Off	Bitstream	Max 7.1ch Bitstream (Max 192Kz)	2ch PCM (48KHz)	2ch	2ch
		PCM	Max 7.1ch PCM (Max 192KHz) *2	2ch PCM (48KHz)	2ch	2ch
Digital Output	On	Bitstream	2ch PCM (48KHz)	Max 5.1ch Bitstream (48KHz)	2ch	2ch
		PCM	2ch PCM (48KHz)	2ch PCM (48KHz)	2ch	2ch
	Off	Bitstream	2ch PCM (48KHz)	Max 5.1ch Bitstream (48KHz) *3	2ch	2ch
		PCM	2ch PCM (48KHz)	2ch PCM (48KHz) *3	2ch	2ch
7.1ch Audio Output	On	—	2ch PCM (48KHz)	2ch PCM (48KHz)	Max 7.1ch *1	2ch
	Off	—	2ch PCM (48KHz)	2ch PCM (48KHz)	Max 7.1ch	2ch
2ch Audio Output	On	—	2ch PCM (48KHz)	2ch PCM (48KHz)	2ch	2ch
	Off	—	2ch PCM (48KHz)	2ch PCM (48KHz)	2ch	2ch

*1 Max 5.1ch PCM in case of playing DTS audio stream (including DTS-HD).

*2 DTS-HD Master Audio with Multi channel 192kHz is output in "Multi channel 96kHz" format.

*3 96kHz signal is output when the playing content is recorded in 96kHz, and is not copy protected.

*4 MPEG Audio is output in 2ch PCM format.

Troubleshooting

Refer to the table below when this unit does not function properly. If the problem you are experiencing is not listed below or if the instruction below does not help, turn off this unit, disconnect the power cable, and contact the nearest authorized Yamaha dealer or service center.

■ Power

Problem	Possible causes and solutions
The Player power cannot be turned on.	<ul style="list-style-type: none"> – Is the power cable firmly plugged into the AC outlet? (Page 15) – When the power cable is plugged into an AC outlet, press and hold  on the Player until “RESET” appears on the front panel display. Then, turn on the power. (Page 16)
The Player power is turned off.	<ul style="list-style-type: none"> – Is “Auto Power Off” set to “Yes”? When “Auto Power Off” is set to “Yes”, the power will be automatically turned off after 10 continuous minutes of inactivity (no playback). (Page 33)

■ Basic Operation

Problem	Possible causes and solutions
The remote control does not work.	<ul style="list-style-type: none"> – Use the remote control within its operating range. (Page 16) – Replace the batteries. (Page 16) – Check the ID settings for the main unit and the remote control. (Page 7.)
Cannot operate the Player.	<ul style="list-style-type: none"> – Are you operating the Player within the specified operating temperature range? (Page 43)

■ Disc Playback

Problem	Possible causes and solutions
The Player cannot play a disc.	<ul style="list-style-type: none"> – Take out the disc and clean it. (Page 4) – Make sure that the disc is loaded properly (aligned in disc tray and label-side up). (Page 4) – Make sure that region code on the disc matches that of this Player. (Page 2) – Allow any condensation in or near the Player to dry. (Page 4) – Check that the disc is recorded in the compatible TV system (PAL or NTSC). – The Player cannot play back video which was not recorded normally. (Page 3) – Proper playback may be impossible due to the state of the disc recording, a scratched, warped or dirty disc, the state of the pick-up, or compatibility issues between this Player and the disc being used. (Pages 3, 4) – When the recorded time of a disc is unusually short, playback may not be possible. – BD-RE/R discs recorded in a format other than BDMV cannot be played back. (Page 2)
The disc is automatically ejected after closing the disc tray.	<ul style="list-style-type: none"> – Make sure that the disc is loaded properly (aligned in disc tray and label-side up). (Page 20) – Take out the disc and clean it. (Page 4) – Make sure that region code on the disc matches that of this Player. (Page 2) – Make sure that the disc is playable. (Page 2)
Video stops.	<ul style="list-style-type: none"> – Has the Player been subjected to shock or impact? Are you using it in an unstable location? The Player will stop if it senses shock or vibration.
The Player makes a snapping sound when starting playback or loading a disc.	<ul style="list-style-type: none"> – The player may sometimes make a snapping sound when starting playback if it has not been operated in a while. These sounds are not malfunctions of the Player but are normal operating conditions.

■ Picture

Problem	Possible causes and solutions
No picture.	<ul style="list-style-type: none"> – Make sure that the cables are connected correctly. (Page 8) – Make sure that the connected TV or the AV receiver is set to the correct input. (Page 8) – Take out the disc and clean it. (Page 4) – Make sure that region code on the disc matches that of this Player. (Page 2) – There is no picture from the HDMI output. <ul style="list-style-type: none"> – Are the settings performed correctly? Please check the settings. (Page 30) – There is no picture from the component video output. <ul style="list-style-type: none"> – Are the settings performed correctly? Please check the settings. (Page 30)

Screen freezes and operation buttons do not work.	<ul style="list-style-type: none"> - Press ■, then restart playback. - Turn off the power and turn on the power again. - If the power is not turned off, perform a reset. (Page 41) - Is the disc damaged or dirty? Check the condition of the disc. (Page 4)
There is just audio with no video.	<ul style="list-style-type: none"> - Is the connection cable for video output connected properly? (Pages 9–11)
Video is not output with the desired resolution.	<ul style="list-style-type: none"> - Is “Video Out Select” set correctly? (page 31). - Is “Component Video Out” or “HDMI Video Out” set to the desired resolution? (Pages 30-31).
Widescreen video appears vertically stretched, or black bands appear at the top and bottom of the screen.	<ul style="list-style-type: none"> - Is “TV Aspect Ratio” set to match the connected TV? (Page 30) - If you are using a widescreen TV, is the “TV Aspect Ratio” set to “Wide”? (Page 30) - If you are using a 4:3 TV, is the “Video Out Select” set to “Component”? (Page 31)
4:3 video appears horizontally stretched	
Square noise (mosaic) appears on the screen.	<ul style="list-style-type: none"> - Blocks in images may be visible in scenes with rapid movement due to the characteristics of digital image compression technology.
The playback screen will be disturbed if DVD video is recorded to a VCR, or played back through a VCR.	<ul style="list-style-type: none"> - This Player complies with analog copy protection. Some discs contain a copy prohibiting signal. If you try to play back such discs through a VCR, or record to a VCR and play back the signal, the copy protection will prevent normal playback. (Pages 10–11)
Audio is not output, or images are not played back properly.	<ul style="list-style-type: none"> - The audio may not be output or the images may not be played back properly for some discs in which copyright-protected contents are recorded.

■ Sound

Problem	Possible causes and solutions
No sound, or sound is distorted.	<ul style="list-style-type: none"> - If the volume of the TV or amplifier is set to minimum, turn the volume up. - There is no sound during still mode, slow motion playback, fast forward and fast reverse. (Page 20) - Check that the audio cable is connected correctly. (Page 12) - Check that the cable plugs are clean. - Take out the disc and clean it. (Page 4) - Audio may not be output depending on the audio recording status, such as when audio other than an audio signal or non-standard audio is recorded for the audio content of the disc. (Page 3)
Left and right channels of audio are reversed, or sound comes out of only one side.	<ul style="list-style-type: none"> - Are left and right audio cables connected to the opposite terminal, or is one side disconnected? (Page 13)
Audio is not output, or images are not played back properly.	<ul style="list-style-type: none"> - The audio may not be output or the images may not be played back properly for some discs in which copyright-protected contents are recorded.
Cannot hear the desired audio type and/ or number of channels.	<ul style="list-style-type: none"> - Refer to “Audio Out” setting (Page 31) and “About the audio output formats”. (Page 38)

■ Network

Problem	Possible causes and solutions
Cannot connect to the Internet.	<ul style="list-style-type: none"> - Is the Network cable connected properly? - Is the wrong cable such as a modular cable used? Connect a Network cable to the NETWORK terminal. (Page 14) - Is the power for the connected equipment, such as broadband router or modem turned on? - Is the broadband router and/or modem properly connected? - Is the proper value(s) set in the network setting? Check “Communication Setup”. (Pages 34–36)
Cannot download BD-LIVE contents.	<ul style="list-style-type: none"> - Is the LAN cable connected properly? - Is the USB memory device properly connected? Check that the USB memory device is connected to the USB BD STORAGE/SERVICE terminal of this Player. - Check if the BD disc supports BD-LIVE. - Check the setting for “BD Internet Access”. (Page 33)

■ Other

Problem	Possible causes and solutions
The TV operates incorrectly.	– Some TVs with wireless remote control capability may operate incorrectly when using the remote control of this Player. Use such TVs away from this Player.
The Player heats up during use.	– When using this Player, the console cabinet may heat up depending on the usage environment. This is not a malfunction.

■ Messages Relating to BD disc and DVD disc

- The following messages appear on the TV screen in case the disc you tried to playback is not appropriate or the operation is not correct.

Error message	Possible Error	Possible Error
Cannot play.	– The disc cannot be played back with this Player.	– Check the disc, and load it correctly.
Incompatible disc.	– If you load a disc which cannot be played with this Player (i.e. a scratched disc), or if you load a disc upside down, this message will appear, and the disc tray will automatically pop out.	– Remove the disc.
	– Occurs if the loaded disc cannot be played because it is a non-standard disc or scratched, etc.	
Cannot operate.	– Occurs if an operation is incorrect.	
This USB memory is not formatted properly. Please format the memory in USB memory management.	– Occurs if there is a formatting error.	– Format the USB memory again.
	– Occurs if the USB memory is not formatted with FAT 32/16.	– Format the USB memory with your PC.
The Connected USB Memory cannot be used. It should be compliant with USB 2.0	– Occurs if USB memory not compliant with USB 2.0 High Speed (480Mbit/s) is used (i.e. USB 1.0/USB 1.1).	– Connect USB 2.0 High Speed (480Mbit/s) compliant USB memory.

To Reset this Player



If this Player receives strong interference from a source such as excessive static electricity, strong external noise, malfunction of power supply, or voltage caused by lightning during use or a wrong operation is sent to the Player, errors like the Player not accepting an operation may occur.

- ① Press and hold  on the Player until “RESET” appears on the front panel display when the Player does not operate properly even after the power has been turned off.
- ② Turn on the power.

Notes

- When a reset is performed while the power is on, the Player will turn off. Turn the power on again. At this point, it may take a few moments for the system processing to finish before the Player is ready for use.
- When the problem persists even after performing a reset, unplug the power cable and plug it in again. If this does not solve the problem, contact the nearest service center approved by Yamaha.

Keylock function

You can set the keylock to prevent accidental operations. Press and hold  and  on the front panel for more than 4 seconds while no disc is inserted in this Player and the disc tray is closed.

- Each time you perform this operation, the function is activated or deactivated.
- If you try to operate the Player while the keylock function is set, “Lock” blinks on the front panel display to indicate that the keylock function is set.

Glossary

AVCHD

AVCHD is a new format (standard) for high definition video cameras that can be used to record and play high-resolution HD images.

BD-J application

The BD-ROM format supports Java for interactive functions. “BD-J” offers content providers almost unlimited functionality when creating interactive BD-ROM titles.

BDMV (Page 2)

BDMV (Blu-ray Disc Movie, BD-MV) refers to one of the application formats used for BD-ROM which is one of the Blu-ray Disc specifications. BDMV is a recording format equivalent to DVD-video of the DVD specification.

Dolby Digital

A sound system developed by Dolby Laboratories Inc. that gives movie theater ambience to audio output when the product is connected to a Dolby Digital processor or amplifier.

Dolby Digital Plus

A sound system developed as an extension to Dolby Digital. This audio coding technology supports 7.1 multi-channel surround sound.

Dolby TrueHD

Dolby TrueHD is a lossless coding technology that supports up to 8 channels of multi-channel surround sound for the next generation optical discs. The reproduced sound is true to the original source bit-for-bit.

DTS

This is a digital sound system developed by DTS, Inc. for use in cinemas.

DTS-HD High Resolution Audio

DTS-HD High Resolution Audio is a new technology developed for the next generation high definition optical disc format.

DTS-HD Master Audio

DTS-HD Master Audio is a lossless audio compression technology developed for the next generation high definition optical disc format.

DTS-HD Master Audio | Essential

DTS-HD Master Audio | Essential is a lossless audio compression technology developed for the next generation high definition optical disc format.

DVD upscaling (page 20)

Upscaling (upconverting) refers to a function of various players and devices that enlarge the image size to fit the size of the screen of video equipments such as a TV.

HDMI (page 9)

HDMI (High-Definition Multimedia Interface) is an interface that supports both video and audio on a single digital connection. The HDMI connection carries standard to high definition video signals and multi-channel audio signals to AV components such as HDMI equipped TVs, in digital form without degradation.

Interlace format

Interlace format shows every other line of an image as a single “field” and is the standard method for displaying images on television. The even numbered field shows the even numbered lines of an image, and the odd numbered field shows the odd numbered lines of an image.

Letter Box (LB 4:3) (page 30)

A screen size with black bars on the top and bottom of the image to allow viewing of wide-screen (16:9) material on a connected 4:3 TV.

Linear PCM Sound

Linear PCM is a signal recording format used for Audio CDs and on some DVD and Blu-ray discs. The sound on Audio CDs is recorded at 44.1 kHz with 16 bits. (Sound is recorded between 48 kHz with 16 bits and 96 kHz with 24 bits on DVD video discs and between 48 kHz with 16 bits and 192 kHz with 24 bits on BD video discs.)

MPEG-2

MPEG-2 (Moving Picture Experts Group phase 2) is one of the video data compression schemes, which is adopted for DVD videos and digital broadcasts worldwide. Some Blu-ray Discs also use high bitrate MPEG-2.

Pan Scan (PS 4:3) (page 30)

A screen size that cuts off the sides of the image to allow viewing of wide-screen (16:9) material on a connected 4:3 TV.

Progressive format

Compared to the Interlace format that alternately shows every other line of an image (field) to create one frame, the Progressive format shows the entire image at once as a single frame. This means that while the Interlace format can show 30 frames/60 fields in one second, the Progressive format can show 60 frames in one second. The overall picture quality increases and still images, text, and horizontal lines appear sharper.

Subtitles (page 26)

These are the lines of text appearing at the bottom of the screen which translate or transcribe the dialog. They are recorded on many DVD and BD video discs.

Top menu (page 22)

In a BD/DVD video, this is the menu for selecting things like the chapter to be played back and the subtitle language. In some DVD videos, the top menu may be called the “Title Menu”.

x.v.Color

x.v.Color reproduces a greater range of color than before, showing almost all of the colors that the human eye can detect. (Applicable for JPEG files only with this system)

Specifications

■ General

Power Supply	
[U.S.A. model]	AC 120 V, 60 Hz
[South America model]	AC 110–120 V, 50/60 Hz
[Australia model]	AC 240 V, 50 Hz
[Europe and Russia models]	AC 230 V, 50 Hz
[Asia model]	AC 220–240 V, 50/60 Hz
Power consumption (Normal)	25 W
Power consumption (Standby)	1 W
Dimensions (W x H x D)	435 x 96 x 315.5 mm (17-1/8 x 3-3/4 x 12-1/2 in)
Weight	4.6 kg (10.1 lbs)

■ Audio Performance

Audio output level (1 kHz, 0 dB, BD/DVD/CD-DA)	2 ± 0.3 V
Signal to noise ratio (BD/DVD/CD-DA)	115 dB or more
Dynamic range	
BD/DVD	105 dB or more
CD-DA	100 dB or more
Harmonic distortion (1 kHz)	
BD/DVD	0.0028 % or less
CD-DA	0.003 % or less
Frequency response	
BD/DVD	2 Hz to 22 kHz (48 kHz Sampling)
	2 Hz to 44 kHz (96 kHz Sampling)
CD-DA	2 Hz to 20 kHz

■ Input/Output

HDMI output	
[U.S.A. and South America models]	Type A Connector x 1 480p/720p/1080i/1080p/1080p@24Hz, Deep Color, x.v. Color support
[Australia, Europe and Russia models]	Type A Connector x 1 480p/576p/720p/1080i/1080p/1080p@24Hz, Deep Color, x.v. Color support
Component video output	Y: 1 Vp-p (75 ohms) Pb, Pr: 0.7 Vp-p (75 ohms)
S video output	
[U.S.A. and South America models]	Y: 1 Vp-p (75 ohms) C: 0.286 Vp-p (75 ohms)(NTSC)
[Australia, Europe and Russia models]	Y: 1 Vp-p (75 ohms) C: 0.3 Vp-p (75 ohms)(PAL)
Video output	1 Vp-p (75 ohms)
Digital output	Optical x 1, Coaxial x 1
Analog audio output	7.1ch x 1, Mixed 2ch x 1
USB	Used for: 1) Playback BD-LIVE/BonusView contents 2) Firmware Update
Other output equipments	Remote IN/OUT x 1, RS-232C x 1 (for custom installer), Ethernet x 1 (for BD-LIVE)

Specifications are subject to change without notice.

Information on the Software License for This Product

Software composition

The software included in this product is comprised of various software components whose individual copyrights are held by Yamaha or by third parties.

Software developed by Yamaha and open source software

The copyrights for the software components and various relevant documents included with this product that were developed or written by Yamaha are owned by Yamaha and are protected by the Copyright Act, international treaties, and other relevant laws. This product also makes use of freely distributed software and software components whose copyrights are held by third parties. These include software components covered by a GNU General Public License (hereafter GPL), a GNU Lesser General Public License (hereafter LGPL) or other license agreement.

Note on source code distribution

This product includes software code subject to the GNU General Public License (GPL) or the GNU Lesser General Public License (LGPL). The copy, distribution, or change of this software code is licensed under the terms of the GPL or the LGPL. The source code is available at the following website:
<http://www.global.yamaha.com/download/>

The source code is also available on a physical media (such as a CD-ROM) at actual cost.
Contact: AV products division, YAMAHA CORPORATION,
10-1 Nakazawa-cho, Naka-ku, Hamamatsu 430-8650,
Japan

In principle, the source code is offered for 3 years from the day of purchase.

Acknowledgements

The following open source software components are included in this product:
• linux kernel • glibc • OpenSSL • modutils • DirectFB • zlib

Software License Notice

Software License Notice Requirements

The software components incorporated into this product include components whose copyright holders require license notices. The license notices for these software components are shown below.

OpenSSL License

This product includes software developed by the OpenSSL Project for use in the OpenSSL Toolkit.
(<http://www.openssl.org>)

Original SSLeay License

This product includes cryptographic software written by Eric Young (eay@cryptsoft.com).

BSD License

This product includes software developed by the University of California, Berkeley and its contributors.

PRECAUCIONES DE SEGURIDAD IMPORTANTES

Lea atentamente estas instrucciones de funcionamiento antes de utilizar este aparato. Siga las instrucciones de seguridad de la unidad y las instrucciones de seguridad pertinentes que aparecen más abajo. Mantenga a mano estas instrucciones de funcionamiento para su consulta en el futuro.

- 1 Lea estas instrucciones.
- 2 Guarde estas instrucciones.
- 3 Preste atención a todas las advertencias.
- 4 Siga todas las instrucciones.
- 5 No utilice este aparato cerca del agua.
- 6 Límpielo únicamente con un paño seco.
- 7 No tape las aberturas de ventilación. Instale el aparato siguiendo las instrucciones del fabricante.
- 8 No instale el aparato cerca de fuentes de calor, por ejemplo, radiadores, salidas de aire caliente, estufas u otros aparatos (incluyendo amplificadores) que produzcan calor.
- 9 No anule la seguridad de la clavija polarizada ni la de la clavija con conexión a tierra. Una clavija polarizada tiene dos patillas, una más ancha que la otra. Una clavija con conexión a tierra tiene dos patillas y una espiga de conexión a tierra. La patilla ancha y la espiga se proporcionan para su seguridad. Si la clavija que se proporciona no entra en su toma de corriente, consulte a un electricista para reemplazar la toma de corriente obsoleta.
- 10 Proteja el cable de alimentación para que nadie lo pise ni quede aplastado, especialmente en las clavijas, tomas de corriente y puntos por donde sale del aparato.
- 11 Utilice solamente los accesorios suministrados por el fabricante.
- 12 Utilice el aparato únicamente con el carrito, soporte, trípode, ménsula o mesa especificado por el fabricante, o que se vende con el propio aparato. Cuando utilice un carrito, tenga cuidado al mover la combinación del carrito y el aparato para evitar que se caiga y se estropee.
- 13 Desenchufe este aparato durante las tormentas eléctricas o cuando no lo utilice durante largos periodos de tiempo.
- 14 Solicite todos los trabajos de reparación solamente a personal cualificado. Las reparaciones serán necesarias cuando se haya dañado el aparato de cualquier forma: cuando se haya estropeado el cable o la clavija de alimentación, se hayan derramado líquidos o hayan caído objetos en el interior del aparato, cuando éste haya estado expuesto a la lluvia o a la humedad, cuando no funcione normalmente o cuando se haya caído.



ADVERTENCIA:

PARA REDUCIR EL RIESGO DE INCENDIOS, DESCARGAS ELÉCTRICAS O DAÑOS AL PRODUCTO:

- **NO EXPONGA ESTE APARATO A LA LLUVIA, LA HUMEDAD, GOTEOS O SALPICADURAS, Y NO COLOQUE OBJETOS QUE CONTENGAN LÍQUIDOS, POR EJEMPLO, FLOREROS, ENCIMA DEL APARATO.**
- **EMPLEE ÚNICAMENTE LOS ACCESORIOS QUE SE RECOMIENDAN.**
- **NO RETIRE LA TAPA (O LA CUBIERTA): EN EL INTERIOR NO EXISTEN PIEZAS QUE SE PUEDAN REPARAR. SOLICITE LAS REPARACIONES ÚNICAMENTE A PERSONAL DE MANTENIMIENTO CUALIFICADO.**

¡PRECAUCIÓN!

NO COLOQUE ESTE APARATO EN UNA LIBRERÍA, ARMARIO EMPOTRADO O EN OTRO ESPACIO CERRADO. ASEGÚRESE DE QUE EL APARATO ESTÁ BIEN VENTILADO. PARA PREVENIR EL RIESGO DE DESCARGAS ELÉCTRICAS O DE INCENDIOS DEBIDOS A RECALENTAMIENTOS, ASEGÚRESE DE QUE NO EXISTEN CORTINAS U OTROS MATERIALES QUE OBSTRUYAN LOS ORIFICIOS DE VENTILACIÓN.

¡PRECAUCIÓN!

ESTE PRODUCTO UTILIZA UN LÁSER. SI EMPLEA CONTROLES, AJUSTES O PROCEDIMIENTOS DISTINTOS A LOS ESPECIFICADOS EN ESTE DOCUMENTO PODRÍA EXPONERSE A RADIACIONES PELIGROSAS. NO RETIRE LAS TAPAS Y NO REPARE USTED MISMO EL APARATO. SOLICITE LAS REPARACIONES A PERSONAL CUALIFICADO.

PRECAUCIÓN

Peligro de explosión si la pila está mal colocada. Cámbiela solamente por otra igual o de tipo equivalente.

La toma de corriente se deberá instalar cerca del equipo y con fácil acceso. El enchufe de conexión a la red del cable de alimentación se deberá mantener siempre operativo.

Para desconectar completamente este aparato de la red de alimentación eléctrica, desenchufe el cable.



PRECAUCIÓN

PELIGRO DE DESCARGA ELÉCTRICA NO ABRIRP



PRECAUCIÓN: PARA REDUCIR EL RIESGO DE DESCARGA ELÉCTRICA, NO quite la cubierta. EL USUARIO NO DEBERA DAR NINGUN TIPO DE SERVICIO A NINGUNA PARTE INTERNA. DEBERA SER REALIZADO SOLO POR PERSONAL DE SERVICIO CALIFICADO.



El símbolo del rayo con una flecha, en el interior de un triángulo equilátero, tiene la intención de alertar al usuario de la presencia en el interior del producto de "tensiones peligrosas", sin aislamiento, y de una magnitud suficiente como para constituir un riesgo de descarga eléctrica para las personas.



El símbolo de exclamación dentro de un triángulo equilátero tiene como objeto alertar al usuario de importantes instrucciones de funcionamiento y mantenimiento (reparaciones) en la literatura que acompaña al aparato.

Información de la Comisión Federal de las Comunicaciones (FCC) (para los consumidores de EE. UU.)

1 **AVISO IMPORTANTE: ¡NO MODIFIQUE ESTA UNIDAD!**

Este producto, cuando se instale según se indica en las instrucciones que contiene este manual, satisface los requisitos de la FCC. Las modificaciones no aprobadas expresamente por Yamaha podrían invalidar la autoridad del usuario, concedida por la FCC, para usar el producto.

2 **IMPORTANTE:** Cuando conecte este producto con accesorios y/u otro producto, utilice únicamente cables con blindaje magnético de alta calidad. Se DEBEN utilizar el cable o cables que se suministran con este producto. Siga todas las instrucciones de instalación. El incumplimiento de las directivas podría invalidar la autorización que usted recibe de la FCC para utilizar este producto en los EE. UU.

3 **NOTA:** Este producto ha sido sometido a pruebas y se ha encontrado que cumple con los requisitos que aparecen en las reglas de la FCC, Sección 15, para dispositivos digitales de la Clase "B". El cumplimiento de estos requisitos le proporciona un nivel razonable de seguridad en cuanto a que el uso de este producto en un entorno residencial no tendrá como resultado interferencias negativas con otros dispositivos electrónicos.

Este equipo genera/utiliza frecuencias de radio y, si no se instala y se utiliza de acuerdo con las instrucciones que se encuentran en el manual del usuario, podrían causar interferencias negativas en el funcionamiento de otros dispositivos electrónicos.

El cumplimiento de las reglas de la FCC no garantiza que no se producirán interferencias en todas las instalaciones. Si se descubre que este producto es la fuente de las interferencias, lo que se puede comprobar encendiendo y apagando el aparato, intente por favor eliminar el problema empleando una de las siguientes medidas:

Mueva a en un lugar distinto este producto o el dispositivo que se ve afectado por la interferencia.

Emplee tomas de corriente que estén en circuitos de diferente derivación (interruptor o fusible) o instale filtro(s) de la línea de corriente.

En caso de interferencias de radio o televisión, cambie de sitio o reoriente la antena. Si el conductor de la antena es una cinta conductora de 300 ohmios, cambie el conductor por un cable de tipo coaxial.

Si estas medidas de corrección no producen resultados satisfactorios, póngase por favor en contacto con el minorista local autorizado para distribuir este tipo de productos. Si no puede localizar al minorista apropiado, póngase por favor en contacto con Yamaha Electronics Corp., U.S.A. 6660 Orangethorpe Ave., Buena Park, CA 90620.

Las declaraciones anteriores ÚNICAMENTE conciernen a aquellos productos distribuidos por Yamaha Corporation of America o sus filiales.

Queremos que escuche toda la vida



Yamaha y el Grupo de Electrónica de Consumo de la Asociación de Industrias Electrónicas deseamos que saque el mejor partido a su equipo utilizándolo en un nivel seguro. Un nivel que permite que el sonido llegue alto y claro pero sin ser retumbante o con molestas distorsiones y, lo que es más importante, sin afectar a sus sensibles oídos. Dado que a menudo el daño auditivo como resultado de sonidos a alto volumen no se puede detectar hasta que es demasiado tarde, Yamaha y el Grupo de Electrónica de Consumo de la Asociación de Industrias Electrónicas le recomendamos que evite la exposición prolongada a niveles excesivos de volumen.

PRECAUCIÓN: LEA LAS SIGUIENTES INDICACIONES ANTES DE UTILIZAR ESTE APARATO.

- 1 Lea atentamente este manual para garantizar el mejor rendimiento de este aparato. Guárdelo en un lugar seguro para poder consultarlo en el futuro.
- 2 Instale este sistema de sonido en un lugar bien ventilado, fresco, seco, limpio y alejado de la luz solar directa, y de fuentes de calor, vibración, polvo, humedad y/o frío. Para proporcionar una ventilación adecuada, permita que haya las siguientes holguras mínimas.
Superior : 10 cm.
Posterior: 10 cm.
Lateral: 10 cm.
- 3 Sitúe este aparato lejos de otros aparatos eléctricos, motores o transformadores para evitar los ruidos de zumbido.
- 4 No exponga este aparato a cambios bruscos de temperatura, ni lo coloque en lugares con alta humedad (por ejemplo, en una habitación con humidificador), para impedir de esa forma que se forme en su interior condensación que podría provocar descargas eléctricas, incendios, daños en el aparato y/o lesiones personales.
- 5 Evite instalar este aparato en un lugar donde puedan caer encima objetos extraños o donde quede expuesto a goteos o a salpicaduras de líquidos. No coloque encima de este aparato:
 - Otros componentes porque que pueden provocar daños y/o decoloración de la superficie de este aparato.
 - Objetos con fuego (velas, por ejemplo) porque pueden provocar incendios, daños en el aparato y/o lesiones personales.
 - Recipientes con líquidos se que puedan caer y derramar el líquido, causando descargas eléctricas al usuario y/o daños en el aparato.
- 6 No tape este aparato con periódicos, manteles, cortinas, etc. que puedan impedir la salida del calor. Si se incrementa la temperatura en el interior del aparato, se pueden provocar incendios, daños en el aparato y/o lesiones personales.
- 7 No enchufe este aparato en una toma de corriente hasta que haya realizado todas las conexiones.
- 8 No ponga el aparato boca abajo. Podría recalentarse y provocar daños potenciales.
- 9 No utilice una fuerza excesiva en los interruptores, perillas y/o cables.
- 10 Cuando desconecte el cable de alimentación de la toma de corriente, sujételo por la clavija y no tire del cable.
- 11 No limpie este aparato con disolventes químicos que podrían estropear el acabado. Utilice un paño limpio y seco para limpiar el aparato.
- 12 Utilice solamente la tensión especificada en este aparato. Utilizar el aparato con una tensión superior a la especificada resulta peligroso y puede producir un incendio, daños en el aparato y/o lesiones a las personas. Yamaha no se hará responsable de ningún daño debido al uso de este aparato con una tensión diferente de la especificada.
- 13 Para impedir daños debidos a los relámpagos, desconecte el cable de alimentación de la toma de corriente o de esta unidad durante las tormentas eléctricas.
- 14 No intente modificar ni arreglar este aparato. Póngase en contacto con el personal de Yamaha cualificado para el mantenimiento cuando necesite realizar alguna reparación. La caja no se deberá abrir nunca por ninguna razón.
- 15 Cuando no piense utilizar este aparato durante un período prolongado de tiempo (cuando se ausente de casa por vacaciones, por ejemplo), desconecte el cable de alimentación de la toma de corriente.

- 16 No se olvide de consultar la sección “Resolución de problemas” antes de dar por concluido que su aparato está averiado.
- 17 Antes de mover esta unidad, pulse  para poner el equipo en el modo de espera y desenchufe el cable de alimentación de la toma de corriente.
- 18 La condensación se formará cuando cambie de repente la temperatura ambiental. Desconecte el cable de alimentación de la toma de corriente y no utilice la unidad.
- 19 La unidad se calentará cuando se utilice durante mucho tiempo. Desconecte la alimentación y no utilice la unidad para permitir que se enfríe.
- 20 Instale esta unidad cerca de la toma de corriente y en donde se pueda alcanzar fácilmente el enchufe de alimentación.
- 21 Las pilas no se deberán exponer a un calor excesivo como, por ejemplo, la luz solar directa, el fuego o similares.

Esta unidad no se desconecta de la fuente de alimentación mientras siga conectada a una toma de corriente, aunque se haya apagado la unidad pulsado . A este estado se le llama modo de espera. En dicho estado, la unidad está diseñada para consumir una cantidad de corriente muy pequeña.

ADVERTENCIA
PARA REDUCIR EL RIESGO DE INCENDIOS O DE DESCARGAS ELÉCTRICAS, NO EXPONGA ESTA UNIDAD A LA LLUVIA O A LA HUMEDAD.

El componente láser de este producto es capaz de emitir radiaciones que sobrepasan el límite para la Clase 1.

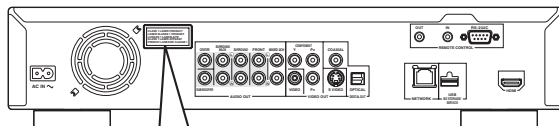

**CLASS 1 LASER PRODUCT
LASER KLASSE 1 PRODUKT
LUOKAN 1 LASERLAITE
KLASS 1 LASER APPARAT
PRODUIT LASER DE CLASSE 1**

Índice general

1

2

3

4

5

1. INTRODUCCIÓN

Acerca de los discos	2
Tipos de discos que se pueden utilizar con este reproductor	2
Discos que no se pueden utilizar con este reproductor...	3
Precauciones con los discos	4
Para empezar	5
Accesorios suministrados	5
Iconos utilizados en este manual de instrucciones	5
Propiedad intelectual	5
Controles y funciones	6
Panel delantero	6
Panel trasero	6
Mando a distancia	7

2. CONEXIONES

Introducción a las conexiones	8
Terminal de vídeo/audio en este reproductor	8
Terminales/tomas de vídeo en este reproductor (conectar ①, ② ó ③)	8
Terminales/tomas de audio en este reproductor (conectar ①, ② ó ③)	8
Conexión a Internet de banda ancha	8
Conexión del dispositivo USB	8
Conexiones HDMI	9
Conexión con el terminal HDMI	9
Conexiones para vídeo	10
Conexión con las tomas de componente	10
Conexión con la toma de vídeo o de S-vídeo	11
Conexiones de audio	12
Conexión con el terminal/toma de audio digital	12
Conexión con las tomas de audio	13
Conexión a Internet de banda ancha	14
Conexión con los puertos NETWORK y USB BD STORAGE/SERVICE	14
Otras conexiones	15
Conexión con los terminales REMOTE CONTROL ...	15
Conexión del cable de alimentación	15

3. REPRODUCCIÓN DE DISCOS

Antes de comenzar a reproducir	16
Instalación de las pilas en el mando a distancia	16
Conexión de la alimentación	16
Indicadores del visor del panel delantero	16
Configuración del idioma que se visualiza en la pantalla	17
Actualización del software de esta unidad	17
Configuración de la salida de audio	18
Preparativos para BD-LIVE	18
Activación del audio secundario	18
Control del reproductor de discos Blu-ray con la función de control HDMI™	18
Reproducción de BD/DVD/CD	20
Para cargar un disco	20
Operaciones básicas de reproducción	20
Disfrute de sonido puro de alta fidelidad (función Pure Direct)	21
Reproducción repetida	21
Utilización de los menús BD/DVD	22
Utilización del menú DVD-R/-RW	22

Utilización del menú de reproducción de CDs de audio	24
Disfrute de BONUSVIEW o BD-LIVE	24
Pantalla de control de funciones	25
Visualización de la información del disco	27
Reproducción de archivos JPEG	28
Cómo reproducir Imágenes fijas en secuencia	28
Reproducción de las imágenes fijas de una carpeta determinada	28
Reproducción de Presentación de Diapositivas	28
Configuración de la velocidad de la presentación de diapositivas/reproducción repetida	28

4. AJUSTES

Ajustes	29
Operaciones habituales	29
Ajustes De Audio Vídeo	30
Configuración de los altavoces	32
Inicio Rápido	33
Apagado Automático	33
Control HDMI	33
Ajustes De La Reproducción	33
Versión	34
Reinicio Sistema	34
Configuración De Comunicaciones	34
Manejo De Memoria USB	36
Actualiz. Software	37

5. INFORMACIÓN ADICIONAL

Resolución de problemas	39
Alimentación	39
Operación básica	39
Reproducción de disco	39
Imagen	39
Sonido	40
Red	40
Otro	41
Mensajes relacionados con discos BD y DVD	41
Glosario	42
Especificaciones	43
Generalidades	43
Rendimiento de audio	43
Entrada/salida	43

(al final de este manual)

Información sobre el software.....i

Acerca de los discos







Tipos de discos que se pueden utilizar con este reproductor







- Con este reproductor se pueden reproducir los siguientes discos. No utilice un adaptador de 8 cm a 12 cm.
- Utilice discos que sean compatibles con los estándares que se indican con la presencia de los siguientes logotipos oficiales marcados en la etiqueta del disco. La reproducción de discos que no cumplan con estos estándares no está garantizada. Además, la calidad de imagen o sonido no está garantizada incluso si tales discos se pueden reproducir.

Tipo de disco	Formato de grabación	Índice general	Tamaño del disco
Vídeo BD	--	Audio + Vídeo (Película)	12 cm
BD-RE DL BD-R DL	Formato BDMV		
Vídeo DVD	Formato vídeo	Audio + Vídeo (Película)	12 cm 8 cm
DVD+RW/ DVD+R DVD+R DL DVD-R DL DVD-RW/ DVD-R	Formato vídeo/ VR/AVCHD (sólo disco finalizado)	Audio + Vídeo (Película)	12 cm 8 cm
CD de audio*1	CD de audio (CD-DA)	Audio	12 cm 8 cm
CD-RW/CD-R	CD de audio (CD-DA) JPEG*2	Imagen fija (archivo JPEG)	

*1 Este reproductor se ha diseñado con la premisa de reproducir CDs de audio que cumplan con los estándares de CD (disco compacto). Este reproductor puede no ser capaz de reproducir los discos compactos que contienen una señal con el propósito de proteger los derechos de autor (señal de control de copia).

*2 Consulte "Acerca del formato de archivo JPEG" en la página 3.

Información de gestión de la región		
Modelo	Vídeo BD	Vídeo DVD
EE. UU.	Código de región "A" o "ALL" 	Número de región "1" o "ALL" 
América del Sur	Código de región "A" o "ALL" 	Número de región "4" o "ALL" 
Europa	Código de región "B" o "ALL" 	Número de región "2" o "ALL" 

Información de gestión de la región		
Modelo	Vídeo BD	Vídeo DVD
Australia	Código de región "B" o "ALL" 	Número de región "4" o "ALL" 
Rusia	Código de región "C" o "ALL" 	Número de región "5" o "ALL" 
Asia	Código de región "A" o "ALL" 	Número de región "3" o "ALL" 

- Los discos y los reproductores de vídeo BD/DVD tienen códigos de región que dictan las regiones en las que se puede reproducir un disco. Consulte los códigos de región en "Información de gestión de la región" (pág. 2)
- Las operaciones y funciones de vídeo BD/DVD pueden ser diferentes de las explicaciones que aparecen en este manual y algunas operaciones pueden estar prohibidas debido a las configuraciones del fabricante del disco.
- Si se visualiza una pantalla de menú o instrucciones de funcionamiento durante la reproducción de un disco, siga el procedimiento de funcionamiento visualizado.
- El componente de audio de un vídeo DVD grabado a 96 kHz (PCM lineal) tendrá una salida de audio de 48 kHz durante la reproducción.

Notas

- Según el disco, puede que no sea posible la reproducción de algunos de los discos de las tablas de la columna izquierda.
- "Finalizar" se refiere a una grabadora que procesa un disco grabado de forma que se reproducirá en otros reproductores/grabadoras de DVD y también en este reproductor. En este reproductor sólo se reproducirán discos DVD finalizados. (Este reproductor no tiene una función para finalizar discos.)

■ Discos que no se pueden utilizar con este reproductor

Los siguientes discos no se podrán reproducir o no se reproducirán debidamente en este reproductor. Si se reproduce por error uno de dichos discos, podría dañarse el altavoz.

CDG, CD de vídeo, CD de foto, CD-ROM, CD-TEXT, SVCD, SA-CD, PD, CDV, CVD, DVD-RAM, DVD de audio, BD-RE con el cartucho, CD-MP3, CD-WMA

Los discos con formas raras no se pueden reproducir.

- Los discos con formas raras (discos con forma de corazón o hexagonales, etc.) no se pueden utilizar. La utilización de tales discos provocará fallos.

Los siguientes discos de vídeo BD/DVD no se pueden reproducir.

- Discos que no coinciden con el código/número de región de este reproductor (“Información de gestión de la región”, pág. 2).
- Discos producidos ilegalmente.
- Discos grabados para uso comercial.

Acerca del formato de archivo JPEG

JPEG es un tipo de formato de archivo para guardar archivos de imágenes fijas (fotografías, ilustraciones, etc.). El reproductor le permite reproducir archivos de imágenes fijas en formato JPEG.

Formatos de archivo que no son compatibles.

- No se pueden reproducir imágenes fijas en formatos que no sean JPEG (como TIFF).
- Algunos archivos no se podrán reproducir incluso aunque estén en formato JPEG.
- No se pueden reproducir archivos JPEG progresivos.
- No se pueden reproducir ni archivos de imagen animada ni archivos de audio, y tampoco archivos de formato JPEG animado, incluso si están en formato JPEG.

Otros archivos que no se pueden reproducir.

- Es posible que no pueda reproducir algunas imágenes fijas que haya creado, retocado, copiado o editado de alguna forma en su PC.

Al reproducir archivos, puede experimentar uno o más de los siguientes síntomas.

- Puede tardar cierto tiempo para reproducir archivos dependiendo del número de carpetas, el número de archivos y el volumen de datos de que se trate.
- No se visualiza información EXIF. EXIF son las siglas en inglés de Formato de Archivo de Imagen Intercambiable, y es una norma para almacenar información de intercambio en archivos de imágenes, especialmente en aquellos que utilizan la compresión JPEG. (Consulte más información en <http://exif.org>.)

Al utilizar la unidad para reproducir un disco CD-RW/R con imágenes fijas guardadas (grabadas).

- Con discos CD-RW/R en los que las imágenes fijas están mezcladas con música o películas, sólo se podrán reproducir las imágenes fijas. Puede darse el caso de que no puedan reproducir algunos de estos discos.
- No se pueden reproducir discos multi-sesión.
- Quizá no pueda reproducir algunas imágenes fijas que haya procesado (rotadas o guardadas sobrescribiendo otras imágenes) utilizando software de procesamiento de imágenes o algunas imágenes fijas que haya importado desde Internet o correo electrónico.
- Los discos que este reproductor puede reproducir (reconocer) están limitados a las siguientes propiedades:
 Contiene archivos en formato EXIF
 Resolución de la imagen: Entre 32x32 y 7680x4320 píxeles
 Número máximo de carpetas: 256
 Número máximo de archivos: 256 por carpeta
 Tamaño de archivo: 20MB o menos

Estructura de las carpetas de imágenes fijas (JPEG)

- Con esta unidad puede reproducir imágenes fijas (JPEG) creando una carpeta en un disco como se muestra a continuación. Las imágenes que estén ubicadas directamente en el directorio raíz no se pueden reproducir.

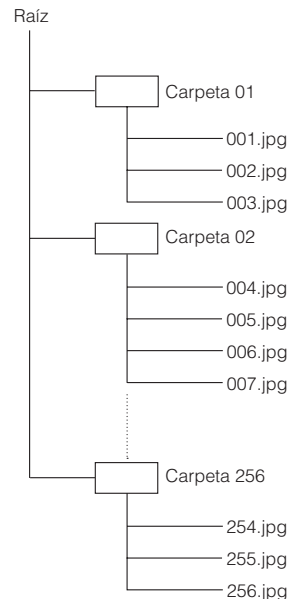





■ Precauciones con los discos

Tenga cuidado con las arañazos y el polvo

- Los discos BD, DVD y CD son sensibles al polvo, huellas dactilares y, en especial, los arañazos. Es posible que no se pueda reproducir un disco con arañazos. Maneje los discos con cuidado y almacénelos en un lugar seguro.

Almacenamiento apropiado de los discos

Ponga el disco en el centro de la caja y almacene la caja y el disco en posición vertical.	
Evite guardar los discos en lugares con luz solar directa, cerca de dispositivos de calefacción o en lugares con alta humedad.	
No deje caer los discos ni los someta a vibraciones o impactos fuertes.	
Evite almacenar los discos en lugares donde haya mucha cantidad de polvo o humedad.	

Precauciones para el manejo



- Si la superficie tiene manchas, límpiela suavemente con un paño suave humedecido (con agua solamente). Cuando limpie los discos, mueva siempre el paño desde el orificio central hacia el borde exterior.



- No utilice pulverizadores de limpieza de discos de vinilo, bencina, diluyente, líquidos para prevención de electricidad estática u otros disolventes.
- No toque la superficie.
- No adhiera papel ni etiquetas adhesivas en el disco
- Si la superficie de reproducción de un disco está manchada o raspada, el reproductor podrá decidir que el disco es incompatible y expulsar la bandeja portadiscos, o podría no reproducir el disco correctamente. Limpie cualquier mancha de la superficie de reproducción con un paño suave.

Limpieza de la lente lectora

- No utilice nunca discos de limpieza de venta en el comercio. La utilización de esos discos podría dañar la lente.
- Solicite la limpieza de la lente en el centro de atención al cliente aprobado por Yamaha más cercano.

Advertencias sobre la formación de condensación

- Podrá formarse condensación en la lente lectora o en el disco en las siguientes condiciones:
 - Inmediatamente después de haber encendido una estufa.
 - En una habitación con vapor o muy húmeda.
 - Cuando se mueva repentinamente el reproductor de un ambiente frío a uno cálido.

Cuando se forme condensación:

- El reproductor tendrá dificultades para leer las señales de los discos y no podrá funcionar adecuadamente.

Para quitar la condensación:

- Extraiga el disco y deje el reproductor con la alimentación apagada que desaparezca la condensación. El uso del reproductor cuando existe condensación podría provocar averías.

■ Accesorios suministrados

Asegúrese de que con el producto se han suministrado los siguientes accesorios.

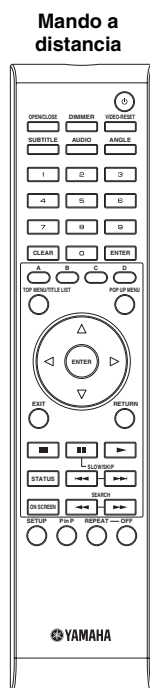

**Pilas (x2)
(AAA, R03, UM-4)**

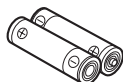

Cable de audio con clavijas

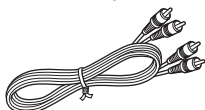

Cable de vídeo con clavijas

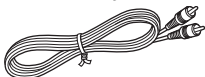

Cable de alimentación

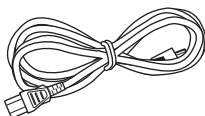

■ Iconos utilizados en este manual de instrucciones

BD-V	Indica las funciones que se pueden realizar para discos de vídeo BD.
BD-RE	Indica las funciones que se pueden realizar para discos BD-RE.
BD-R	Indica las funciones que se pueden realizar para discos BD-R.
DVD-V	Indica las funciones que se pueden realizar para discos de vídeo DVD.
DVD-RW	Indica las funciones que se pueden realizar para discos DVD-RW.
DVD-R	Indica las funciones que se pueden realizar para discos DVD-R.
AUDIO CD	Indica las funciones que se pueden realizar para Audio CD.
CD-R JPEG	Indica las funciones que se pueden realizar para discos CD-R en formato JPEG
CD-RW JPEG	Indica las funciones que se pueden realizar para discos CD-RW en formato JPEG.

■ Propiedad intelectual

- El material audio-visual puede consistir de productos con propiedad intelectual que no se deben grabar sin la autorización del poseedor de dicha propiedad intelectual. Remítase a las leyes aplicables en su país.
- Este producto contiene tecnología de protección de la propiedad intelectual que está protegida por patentes de los EE. UU. y otros derechos de propiedad intelectual. La utilización de esta tecnología de protección de propiedad intelectual debe estar autorizada por Macrovision, y está dirigida al uso doméstico u otros usos limitados excepto en el caso de autorización previa de Macrovision. Se prohíbe la ingeniería inversa o el desarmado de la unidad.

Patentes de EE. UU. números 6.836.549; 6.381.747; 7.050.698; 6.516.132; y 5.583.936

- Fabricado bajo licencia de Dolby Laboratories. “Dolby” y el símbolo de la doble D son marcas comerciales de Dolby Laboratories.
- Fabricado con licencia bajo las patentes de EE. UU. número: 5.451.942; 5.956.674; 5.974.380; 5.978.762; 6.226.616; 6.487.535; 7.392.195; 7.272.567; 7.333.929; 7.212.872 y otras patentes de los EE. UU. e internacionales emitidas o pendientes. DTS es una marca registrada, y el símbolo y logotipos DTS, DTS-HD y DTS-HD Master Audio | Essential son marcas comerciales de DTS, Inc. © 1996-2008 DTS, Inc. Todos los derechos reservados.
- es una marca comercial.
- El logotipo “BD-LIVE” es una marca comercial de Blu-ray Disc Association.
- El logotipo “BONUSVIEW” es una marca comercial de Blu-ray Disc Association.
- es una marca comercial de DVD Format/ Logo Licensing Corporation.
- HDMI, el logotipo HDMI y High-Definition Multimedia Interface son marcas comerciales o marcas registradas de HDMI Licensing LLC.
- “x.v.Color” y el logotipo “x.v.Color” son marcas comerciales.
- “AVCHD” y el logotipo “AVCHD” son marcas comerciales de Panasonic Corporation y Sony Corporation.
- Java y todas las marcas comerciales y logotipos basados en Java son marcas comerciales o marcas registradas de Sun Microsystems, Inc. en los Estados Unidos y/o otros países.
- Este producto se otorga con licencia bajo la licencia de cartera de patentes AVC y la licencia de cartera de patentes VC-1 para su uso personal y no comercial por parte de un consumidor para (i) codificar vídeo que cumpla con las normas AVC y VC-1 (“AVC/VC-1 Video”) y/o (ii) descodificar vídeo AVC/VC-1 codificado por un consumidor dedicado a una actividad personal y no comercial y/o que se obtuvo de un proveedor de vídeo con licencia para proporcionar vídeo AVC/VC-1. No se otorga o se da por supuesta licencia alguna para cualquier otro uso. Se puede obtener información adicional de MPEG LA, LLC. Consulte <http://www.mpegla.com>.

■ Mando a distancia

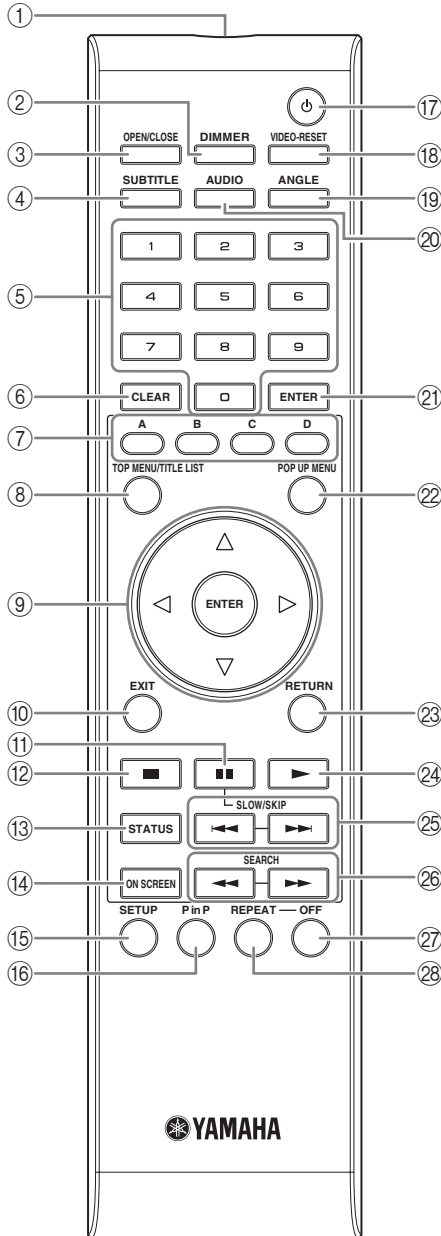

- ① Transmisor de señales infrarrojas (pág. 16)
- ② DIMMER (pág. 16)
- ③ OPEN/CLOSE (pág. 20)
- ④ SUBTITLE (pág. 26)
- ⑤ Teclas numéricas (pág. 26)
- ⑥ CLEAR (pág. 29)
- ⑦ A, B, C, D (pág. 23, 24, 28, 35)
- ⑧ TOP MENU/TITLE LIST (pág. 22, 23)
- ⑨ Teclas cursor (△ / ▽ / ◀ / ▶), ENTER (pág. 17, 30)

- ⑩ EXIT (pág. 28, 29, 30)
- ⑪ ■■ (Pausa) (pág. 20)
- ⑫ ■■ (Parada) (pág. 20)
- ⑬ STATUS (pág. 21, 27)
- ⑭ ON SCREEN (pág. 26)
- ⑮ SETUP (pág. 17, 28, 29)
- ⑯ P in P (pág. 25)
- ⑰ ⏻ (Alimentación) (pág. 16)
- ⑱ VIDEO-RESET (pág. 30, 31)
- ⑲ ANGLE (pág. 26)
- ⑳ AUDIO (pág. 26)
- ㉑ ENTER (pág. 30, 37)
- ㉒ POP UP MENU (pág. 22)
- ㉓ RETURN (pág. 21, 24, 26, 28, 29)
- ㉔ ▶ (Reproducción) (pág. 20)
- ㉕ ◀◀ / ▶▶ (SLOW/SKIP) (pág. 20)
- ㉖ ◀◀ / ▶▶ (SEARCH) (pág. 20)
- ㉗ OFF (pág. 21)
- ㉘ REPEAT (pág. 21, 26)

Función ID

Puede cambiar la ID del mando a distancia para impedir operaciones no deseadas de otros reproductores Yamaha tales como un reproductor DVD. Si ha cambiado la ID del mando a distancia, asegúrese de que selecciona la misma ID para la unidad principal. La configuración predeterminada es ID1.

① Configuración del mando a distancia

Para cambiar la ID de ID1 a ID2, pulse y mantenga pulsando simultáneamente **A** y **2** durante 3 segundos. Para cambiar la ID de ID2 a ID1, pulse y mantenga pulsando simultáneamente **A** y **1** durante 3 segundos.

② Configuración de la unidad principal

Pulse y mantenga pulsado simultáneamente ◀◀◀ y ▶▶▶ en el panel delantero durante más de 2 segundos cuando en este reproductor no se haya introducido un disco y la bandeja portadiscos esté cerrada (se visualiza la ID actual). Siga manteniendo pulsadas las teclas durante 2 segundos más para cambiar la ID entre ID1 y ID2.

Nota

- La ID del mando a distancia se pondrá automáticamente en ID1 si el mando a distancia está sin pilas durante varios minutos o si las pilas gastadas se mantienen en el mando a distancia. Si desea utilizar el mando a distancia en la configuración ID2, instale nuevas pilas y configure de nuevo la ID del mando a distancia.

Introducción a las conexiones

Este reproductor está equipado con los terminales/tomas que se listan más abajo. Encuentre el terminal/toma que corresponde a su equipo de vídeo/audio. Le recomendamos que utilice el terminal HDMI que proporciona vídeo y audio de alta calidad en una única conexión. Si utiliza otros terminales/tomas, conecte primero el vídeo. A continuación, conecte el audio.

■ Terminal de vídeo/audio en este reproductor

① Terminal HDMI



Página 9

■ Terminales/tomas de vídeo en este reproductor (conectar ①, ② ó ③)

Calidad superior



Calidad normal

① Tomas de VIDEO OUT (COMPONENT)

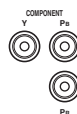

Página 10

② Tomas de VIDEO OUT (S VIDEO)



Página 11

③ Toma de VIDEO OUT (S VIDEO)



Página 11

■ Terminales/tomas de audio en este reproductor (conectar ①, ② ó ③)

① Terminal/toma DIGITAL OUT (COAXIAL/OPTICAL)



Página 12

② Terminales AUDIO OUT (8 canales discretos)

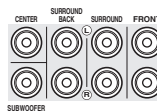

Página 13

③ Terminales AUDIO OUT (MIXED 2CH)



Página 13

■ Conexión a Internet de banda ancha

Terminal NETWORK



Página 14

■ Conexión del dispositivo USB

Puerto USB BD STORAGE/
SERVICE



Página 14

Conexiones HDMI

■ Conexión con el terminal HDMI

- Puede disfrutar de imagen y sonido digital de alta calidad a través del terminal HDMI.
- Conecte firmemente un cable HDMI (disponible en el comercio) en los terminales HDMI (① y ②).
- Consulte la información sobre los formatos de salida de audio en la página 38.
- Emplee cables HIGH SPEED HDMI que tengan el logotipo HDMI (como aparece en la portada).

¡Precaución!

Antes de realizar cualquier conexión, asegúrese de apagar este reproductor y el equipo.

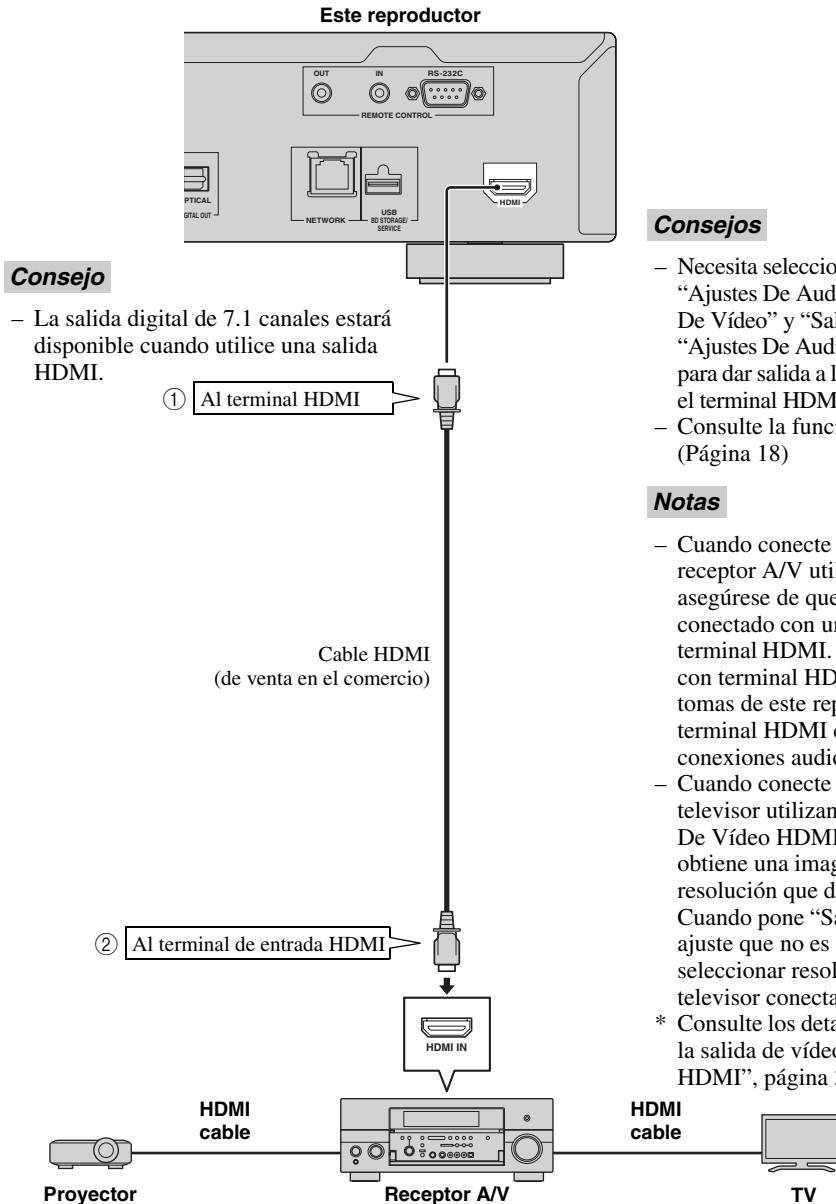

Consejo

- La salida digital de 7.1 canales estará disponible cuando utilice una salida HDMI.

Consejos

- Necesita seleccionar “HDMI” en “Ajustes” – “Ajustes De Audio Vídeo” – “Selección Salida De Vídeo” y “Salida De HDMI” en “Ajustes” - “Ajustes De Audio Vídeo” - “Salida De Audio” para dar salida a las señales audiovisuales desde el terminal HDMI. (página 31)
- Consulte la función de control HDMI. (Página 18)

Notas

- Cuando conecte este reproductor con un receptor A/V utilizando un terminal HDMI, asegúrese de que el receptor A/V está conectado con un televisor mediante un terminal HDMI. Si el televisor no va equipado con terminal HDMI, conecte los terminales/ tomas de este reproductor que no sean el terminal HDMI con el receptor A/V para las conexiones audiovisuales.
 - Cuando conecte el reproductor con un televisor utilizando un cable HDMI, “Salida De Vídeo HDMI” se pone en “Auto”. Si no obtiene una imagen estable, seleccione la resolución que desea*.
Cuando pone “Salida De Vídeo HDMI” en un ajuste que no es “Auto”, solamente puede seleccionar resoluciones compatibles con el televisor conectado.
- * Consulte los detalles sobre las resoluciones de la salida de vídeo HDMI en “Salida De Vídeo HDMI”, página 31.

Conexiones para vídeo

■ Conexión con las tomas de componente

- Puede disfrutar de una reproducción de color precisa y de imágenes de alta calidad a través de las tomas de componente.
- Conecte firmemente un cable de vídeo componente (de venta en el comercio) en las tomas de componente (① y ②).

¡Precaución!

Antes de realizar cualquier conexión, asegúrese de apagar este reproductor y el equipo.

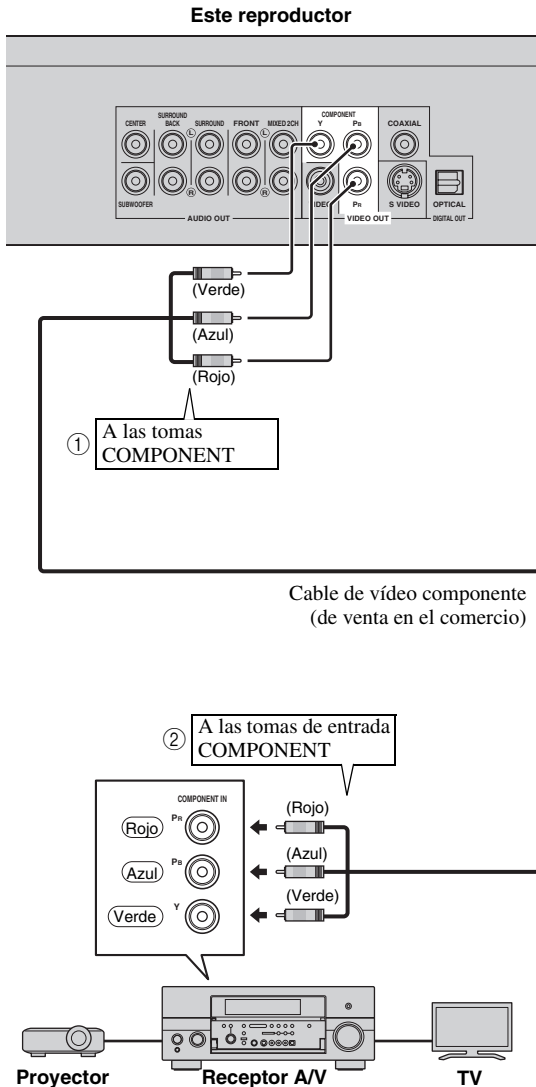

Notas

- Necesita seleccionar "Componente" en "Ajustes" - "Ajustes De Audio Vídeo" - "Selección Salida De Vídeo" para dar salida a la señal de vídeo desde las tomas de componente. (Consulte la página 31.)
- Cuando la salida de vídeo con prioridad está establecida en "HDMI" en "Selección Salida De Vídeo", la resolución del vídeo que sale por las tomas COMPONENT VIDEO OUT es la que se estableció en "Salida De Vídeo HDMI".
- Cuando la salida desde las tomas COMPONENT tenga prioridad, establezca la salida de vídeo con prioridad en "Componente"
- Si reproduce la imagen mediante una videogradora, la imagen puede deteriorarse debido a la función de protección contra la copia.
- Cuando vea un programa con propiedad intelectual protegida, le recomendamos que conecte el reproductor de disco Blu-ray directamente con el televisor con LCD o por medio del receptor A/V.

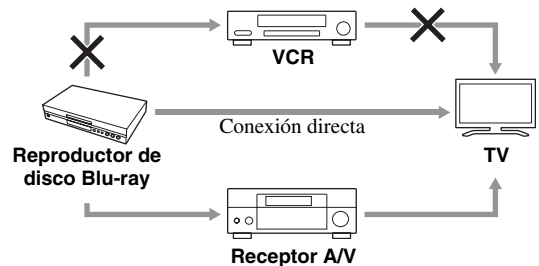

■ Conexión con la toma de vídeo o de S-vídeo

- Conecte la toma de vídeo o la de S-vídeo.
- Conecte con firmeza un cable de S-vídeo (de venta en el comercio) en las tomas de S-vídeo o un cable de vídeo con clavijas (suministrado) en las tomas de vídeo (① y ②, o ③ y ④).

¡Precaución!

Antes de realizar cualquier conexión, asegúrese de apagar este reproductor y el equipo.

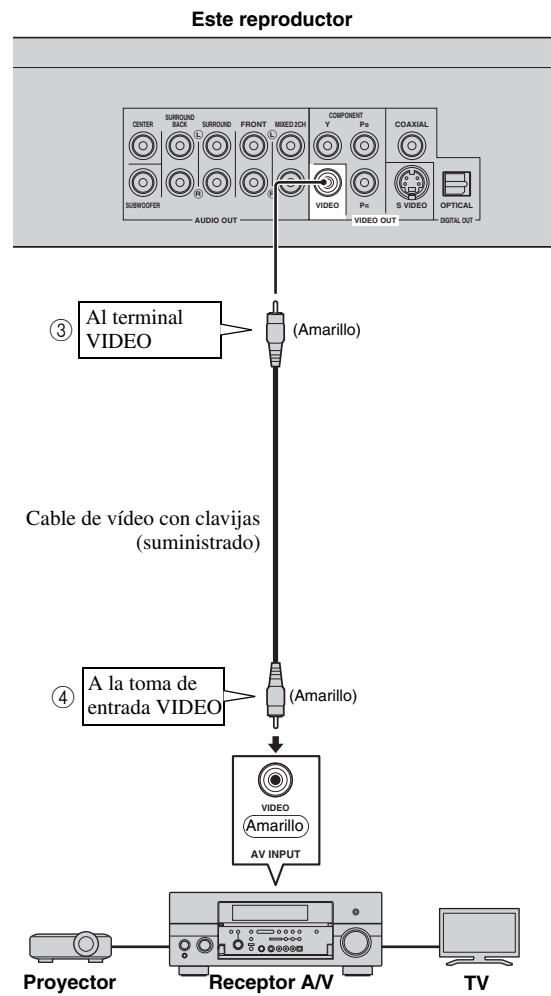
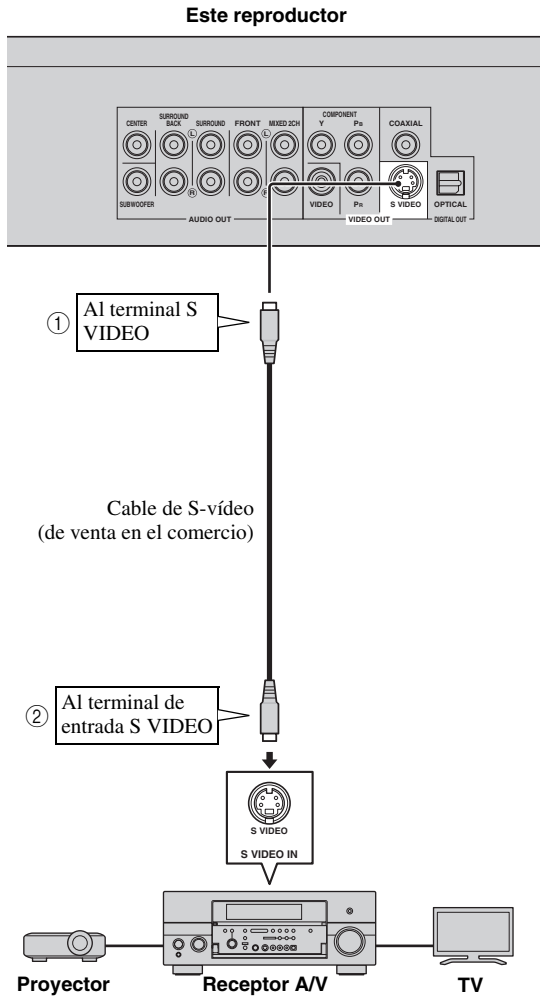

Notas

- Necesita seleccionar “Componente” en “Ajustes” - “Ajustes De Audio Vídeo” - “Selección Salida De Vídeo” para dar salida a la señal de vídeo desde la toma de S-vídeo/vídeo. (Consulte la página 31.)
- Si reproduce la imagen mediante una videograbadora, la imagen puede deteriorarse debido a la función de protección contra la copia.
- Cuando vea un programa con propiedad intelectual protegida, le recomendamos que conecte el reproductor de disco Blu-ray directamente con el televisor con LCD o por medio del receptor A/V.

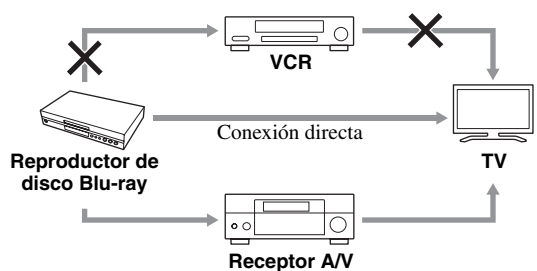

Conexiones de audio

■ Conexión con el terminal/toma de audio digital

- Puede conectar el equipo de audio o el televisor en el terminal/toma DIGITAL OUT.
- Conecte con firmeza un cable de audio digital con clavijas (de venta en el comercio) o un cable óptico (de venta en el comercio) en la toma de audio digital coaxial o en terminal de audio digital óptico (① y ②, o ③ y ④).
- Consulte la información sobre los formatos de salida de audio en la página 38.

¡Precaución!

Antes de realizar cualquier conexión, asegúrese de apagar este reproductor y el equipo.

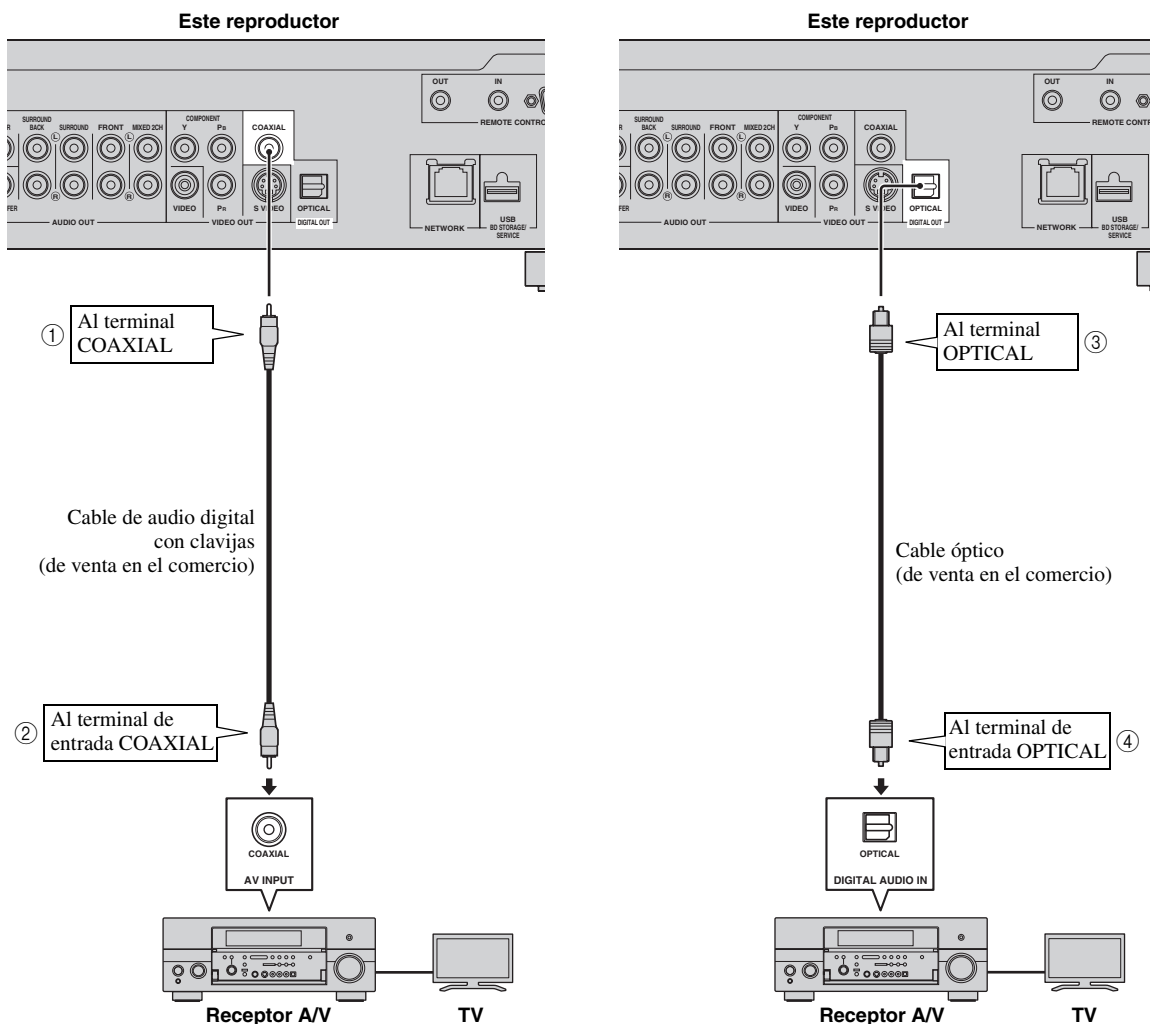

Consejos

- La salida digital 5.1 ch estará disponible cuando utilice una salida COAXIAL/OPTICAL. Salida digital 7.1 ch no está disponible.
- Necesita seleccionar “Salida Digital” en “Ajustes” - “Ajustes De Audio Vídeo” - “Salida De Audio” para dar salida a la señal de audio desde la toma/terminal coaxial u óptica. (Consulte la página 31.)

Nota

- El audio de 7.1 canales está disponible via el terminal HDMI o las tomas de audio discreto de 8 canales.

■ Conexión con las tomas de audio

- Puede conectar el equipo de audio o el televisor en los terminales AUDIO OUT.
- Conecte con firmeza un cable de audio con clavijas (suministrado) o cables de audio con clavijas (suministrado para 2 canales y a la venta en el comercio para los otros 6 canales) en las tomas de audio de 2 canales o en las tomas de audio discreto de 8 canales (① y ②, o ③ y ④).
- Consulte la información sobre los formatos de salida de audio en la página 38.

¡Precaución!

Antes de realizar cualquier conexión, asegúrese de apagar este reproductor y el equipo.

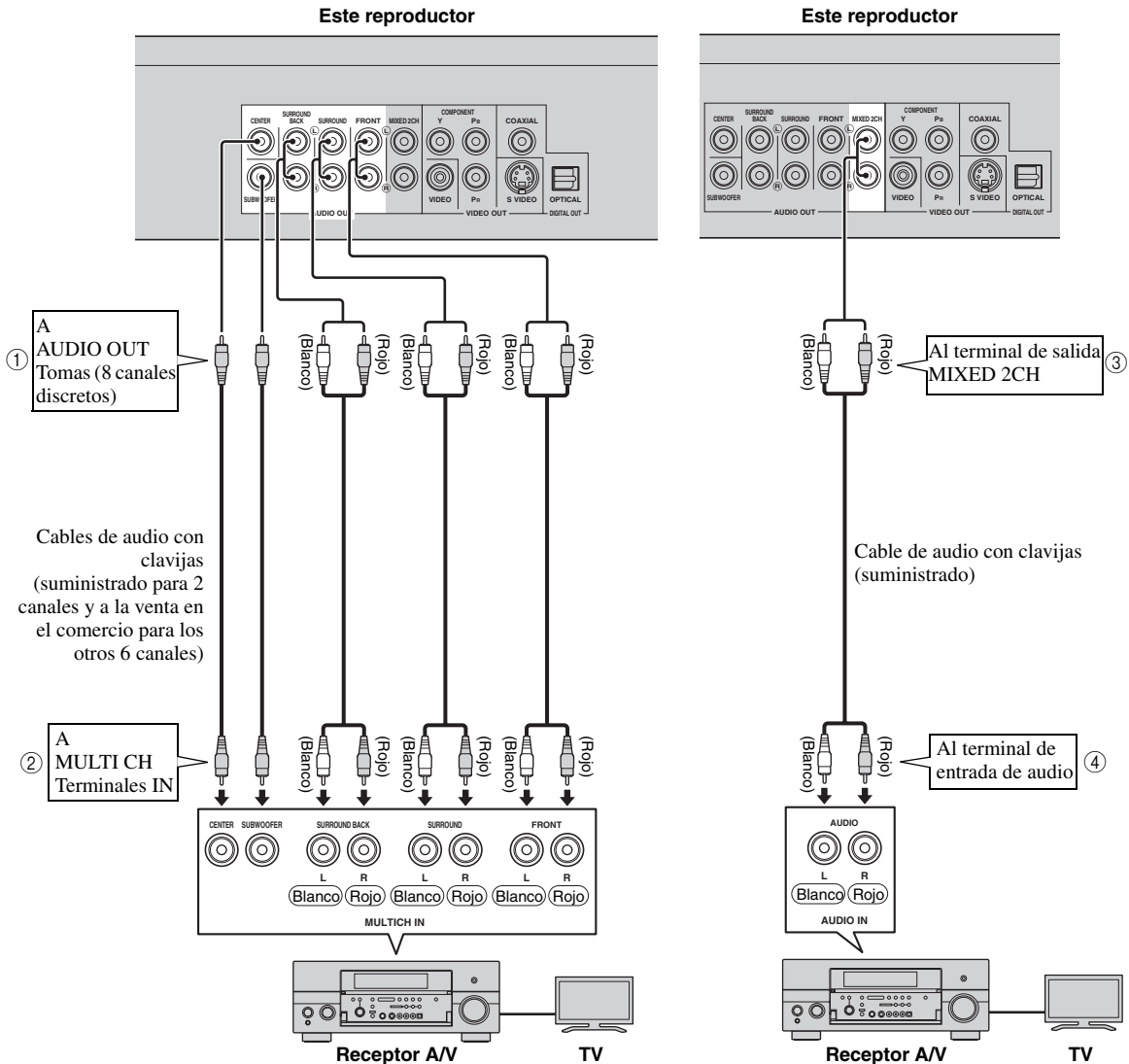

Consejos

- Puede conectar directamente un subwoofer en el terminal SUBWOOFER. Cuando conecte directamente el televisor con este reproductor, conecte en este terminal un subwoofer activo, por ejemplo, el sistema Yamaha Active Servo Processing Subwoofer System.
- Necesita seleccionar "Salida Audio 7.1ch" en "Ajustes" - "Ajustes De Audio Vídeo" - "Salida De Audio" para dar salida a la señal de audio desde los terminales de 8 canales discretos. (Consulte la página 31.)
- Necesita seleccionar "Salida Audio 2ch" en "Ajustes" - "Ajustes De Audio Vídeo" - "Salida De Audio" para dar salida a la señal de audio desde las tomas de audio de 2 canales. (Consulte la página 31.)

Conexión a Internet de banda ancha

■ Conexión con los puertos NETWORK y USB BD STORAGE/SERVICE

- Cuando reproduce discos compatibles con BD-LIVE puede disfrutar de contenido variado con funciones interactivas a través de la conexión a Internet. Para información adicional sobre las funciones BD-LIVE, consulte las páginas 24 y 25.
- Puede conectar un dispositivo de memoria USB (de 2 GB o más y formateado con FAT 32/16) en el puerto USB BD STORAGE/SERVICE para guardar los datos de Paquete Virtual/BD-LIVE o para actualizar el software de este reproductor.
- Conecte firmemente un cable de red (de venta en el comercio) y un dispositivo de memoria USB (de venta en el comercio) en los puertos NETWORK y USB BD STORAGE/SERVICE (① y ② y ③).
- Utilice únicamente un cable de red STP (par trenzado blindado).
- Cuando se emplee Internet, se necesita una conexión a Internet de banda ancha como se muestra más abajo.

¡Precaución!

Antes de realizar cualquier conexión, asegúrese de apagar este reproductor y el equipo.

Notas

- Al usar una conexión a Internet de banda ancha, se requiere un contrato con un proveedor de servicios de Internet. Obtenga más detalles poniéndose en contacto con su proveedor de servicios de Internet más cercano.
- Consulte el manual de manejo de su equipo ya que el equipo conectado y el método de conexión pueden variar dependiendo de su entorno de Internet.
- Emplee un cable de red/enrutador compatible con 10BASE-T/100BASE-TX.

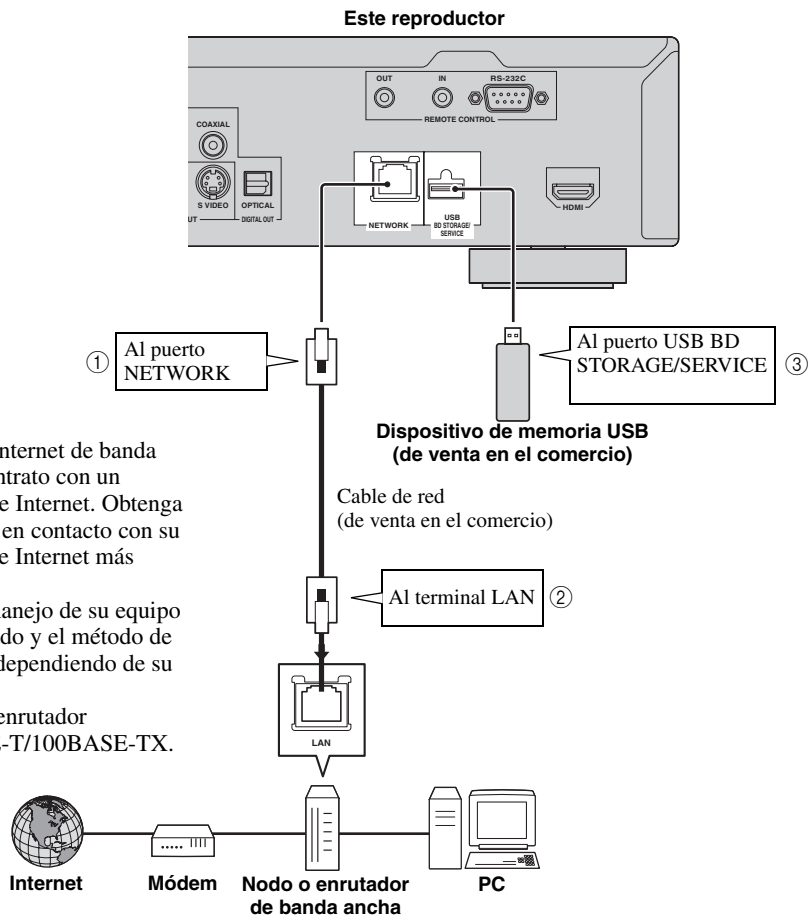

Después de la conexión

- Realice el ajuste de la comunicación. (Página 34–36)
- Cargue un disco compatible con BD-LIVE y reproduzca el contenido. (Página 20–24)

Otras conexiones

■ Conexión con los terminales REMOTE CONTROL

- Puede transmitir las señales del mando a distancia conectando con los terminales REMOTE CONTROL (OUT/IN).
- Conecte con firmeza cables con mini-clavija de 3,5 mm (de venta en el comercio) en los terminales REMOTE CONTROL (OUT/IN) (① y ②), o ③ y ④).

¡Precaución!

Antes de realizar cualquier conexión, asegúrese de apagar este reproductor y el equipo.

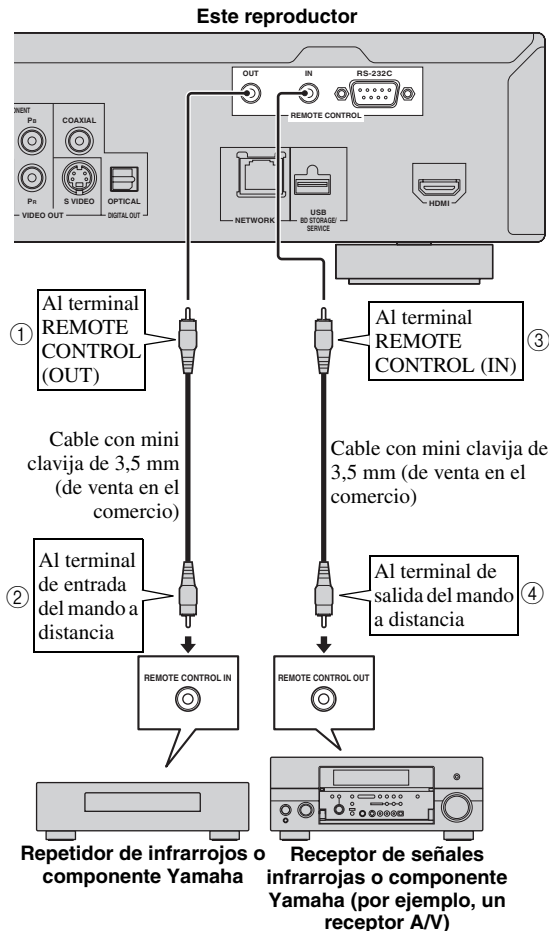

Consejo

- El terminal RS-232C es un terminal de expansión de control sólo para su uso comercial. Consulte los detalles en su distribuidor.

■ Conexión del cable de alimentación

- Enchufe el cable de alimentación que se suministra en el terminal AC IN de la parte posterior del reproductor. Después, enchúfelo en la toma de corriente.

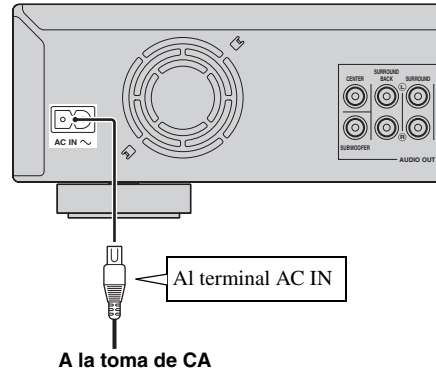

Nota

- PARA PREVENIR EL RIESGO DE DESCARGAS ELÉCTRICAS, NO TOQUE LAS PARTES SIN AISLAMIENTO DE NINGÚN CABLE CUANDO EL CABLE DE ALIMENTACIÓN ESTÉ CONECTADO.

Antes de comenzar a reproducir

■ Instalación de las pilas en el mando a distancia

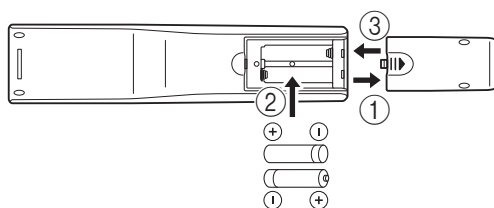

- 1 Pulse la parte y deslice la tapa del compartimento de las pilas para quitarla.
- 2 Introduzca las dos pilas suministradas (AAA, R03, UM-4) en el interior del compartimento para las pilas de acuerdo con las marcas (+/-).
- 3 Ponga la tapa deslizándola hasta que quede fijada.

Notas

- No someta al mando a distancia a golpes, agua ni humedad excesiva.
- El mando a distancia podría no funcionar si el sensor del reproductor está expuesto a la luz solar directa o cualquier otra luz fuerte.
- El uso incorrecto de las pilas puede provocar que revienten o tengan fugas. Lea las advertencias para las pilas y utilícelas correctamente.
- No mezcle pilas viejas y nuevas, ni mezcle diferentes marcas.
- Extraiga las pilas si no va a utilizar el mando a distancia durante un periodo de tiempo prolongado.

Alcance aproximado de funcionamiento del mando a distancia

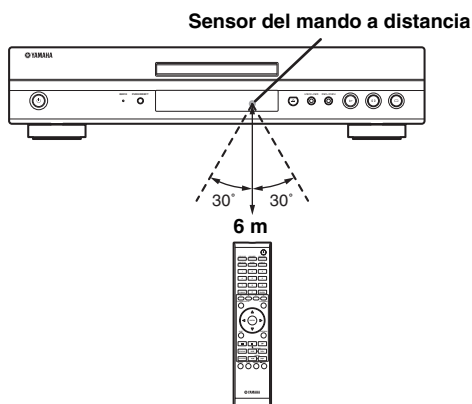

■ Conexión de la alimentación

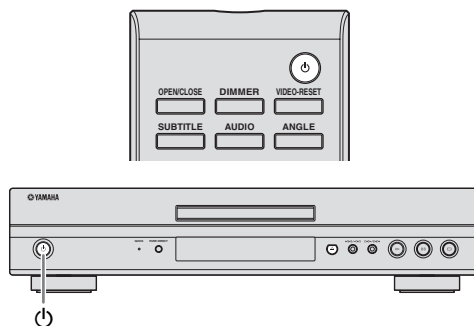

Conexión de la alimentación

Pulse en el mando a distancia o en el reproductor para encender el reproductor.



Entrando en espera

Pulse en el mando a distancia o en el reproductor para activar el modo en espera.

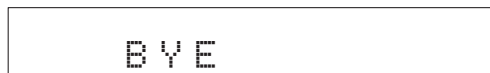

Nota

- Si pulsa otra vez inmediatamente después de haber activado el modo en espera, es posible que el reproductor no se encienda. Si ocurriera esto, espere 10 segundos o más y conecte entonces otra vez la alimentación.

■ Indicadores del visor del panel delantero

Indicador	Descripciones
BD	Se enciende al reproducir un disco BD.
DVD	Se enciende al reproducir un disco de vídeo DVD.
CD	Se enciende al reproducir un CD.
	Se enciende al reproducir.
	Se enciende en las pausas.
TÍTULO	Se enciende al reproducir un DVD o un disco BD.
CHP/TRK	Se enciende al reproducir un disco BD, un DVD o un CD.
REP S	Se enciende cuando se reproduce repetidamente una pista o capítulo.

Indicador	Descripciones
REP ALL	Se enciende cuando se reproduce repetidamente un disco o título.
REP A-B	Se enciende cuando se reproduce repetidamente una sección.

Ajuste del brillo del visor del panel delantero

Si cree que el visor del panel delantero es demasiado brillante cuando está viendo una película, puede ajustar el brillo pulsando repetidamente **DIMMER** en el mando a distancia.

Configuración del idioma que se visualiza en la pantalla

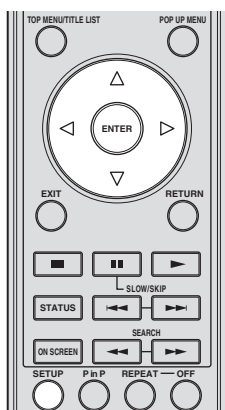

- 1 Pulse **SETUP** para visualizar la pantalla del menú de configuración.



- 2 Pulse Δ / ∇ / \triangleleft / \triangleright para seleccionar "Idioma En La Pantalla" y, a continuación, pulse **ENTER**.



- 3 Pulse Δ / ∇ para seleccionar el idioma que desea ver en la pantalla y, después, pulse **ENTER**.



Notas

- La selección de idioma en el paso 3 es un ejemplo para los modelos de los EE. UU., América Central y del Sur.
- Para seleccionar el idioma del disco DVD, por ejemplo, el idioma de los subtítulos, etc., consulte la página 26.

Actualización del software de esta unidad

Algunos de los discos de vídeo BD publicados recientemente no se pueden reproducir si no se actualiza el software de este reproductor a su última versión. Le recomendamos que actualice el software de esta unidad empleando "Actualiz. Software" para que este reproductor pueda funcionar utilizando el software más reciente.

Para que se pueda cargar el nuevo software, el dispositivo de memoria USB no debe contener ningún archivo excepto los datos de actualización del software. Para comprobar si existe una actualización del software, visite <http://www.yamaha.co.jp/english/product/av/down/agreement.html>.

Cuando se lleva a cabo una actualización del software, hay que escribir antes los datos de actualización del software en el dispositivo de memoria USB utilizando un PC. Cuando se publiquen datos de actualización del software, copie los datos en un dispositivo de memoria USB después de descargarlos a un PC. Utilice un PC para borrar los datos de actualización del software que no se necesiten cuando haya finalizado el proceso de actualización del software.

- 1 Inserte el dispositivo de memoria USB que contiene el archivo de actualización en el puerto USB BD STORAGE/SERVICE situado en la parte trasera de este reproductor.
- 2 Pulse **SETUP** para visualizar la pantalla del menú de configuración.
- 3 Pulse Δ / ∇ / \triangleleft / \triangleright para seleccionar "Ajustes" y, a continuación, pulse **ENTER**.
- 4 Pulse Δ / ∇ para seleccionar "Actualiz. Software" y, a continuación, pulse **ENTER**.
 - Vaya al paso 6 si todavía no ha establecido la contraseña.
- 5 Introduzca el número de 4 dígitos utilizando de 0-9.

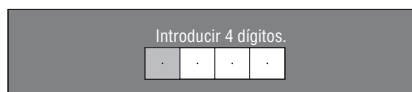

- 6 Pulse **ENTER** para empezar a revisar los datos en el dispositivo de memoria USB.

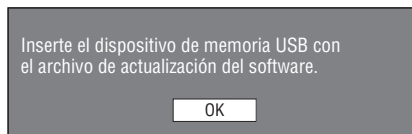

- 7 "Comprobando" parpadeará mientras se estén revisando los datos.



- Se visualizan la versión del software de esta unidad y la versión del archivo de actualización que existe en el dispositivo de memoria USB. Seleccione “Sí” y pulse **ENTER** para actualizar el software de este reproductor utilizando el archivo de actualización.

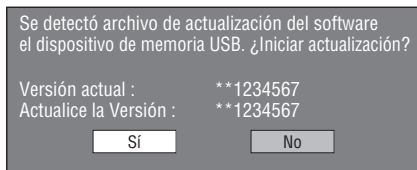

- Se visualizará un mensaje de error si el dispositivo de memoria USB no está instalado correctamente o si no se puede encontrar el archivo de actualización en el dispositivo de memoria USB. Revise el archivo en el dispositivo de memoria USB y, a continuación, vuelva a introducir correctamente dicho dispositivo.

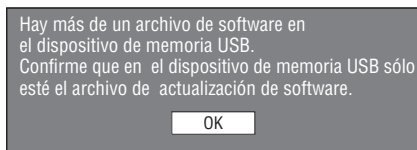
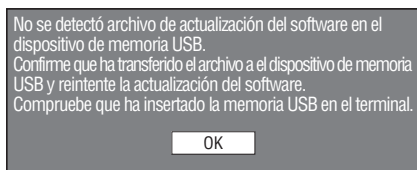

- 8 Pulse **ENTER** para iniciar la actualización.
 - La pantalla se oscurecerá momentáneamente hasta que se pueda visualizar la pantalla de actualización. Espere por favor hasta que aparezca la pantalla de actualización. No desconecte el cable de alimentación.

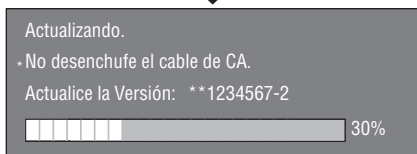
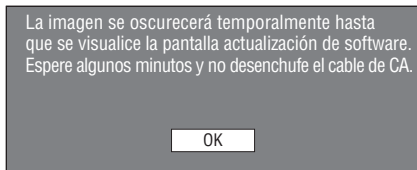

- 9 Cuando el software se haya actualizado con éxito, aparecerá una pantalla indicado que el proceso de actualización ha finalizado.
 - Si la actualización no se ha podido realizar, revise el archivo en el dispositivo USB y vuelva a intentar actualizar el software.
- 10 Pulse **⏻** para apagar el reproductor.
- 11 Retire el dispositivo de memoria USB.

Consejo

- Puede borrar la cifra de 4 dígitos pulsando **CLEAR**.
- Puede utilizar **ENTER** en la parte inferior derecha de las teclas **Núméricas** en vez de **ENTER** en las teclas de **Cursor**.
- También se puede actualizar el software introduciendo un CD-ROM con el archivo de actualización.

Configuración de la salida de audio

Para dar salida correcta del audio, configure la salida de sonido que adecuada para su entorno de reproducción utilizando “Salida De Audio”. Consulte “Operaciones habituales” y “Salida De Audio” en la página 29 y en la página 31.

Preparativos para BD-LIVE

BD-LIVE es una nueva característica de los discos Blu-ray que le permite descargar y disfrutar de trailers de películas y de opciones extras desde Internet.

- 1 Conecte este reproductor con Internet. (Página 14.)
- 2 Introduzca un dispositivo de memoria USB (de 2 GB o más y formateado en FAT 32/16) que soporte USB de alta velocidad (480 Mbit/s) en el puerto USB BD STORAGE/SERVICE ubicado en la parte trasera de este reproductor. (Página 14.)
- 3 Prepare un disco de vídeo BD que sea compatible con BD-LIVE. (Consulte “Disfrute de BONUSVIEW o BD-LIVE” en la página 24.)

Activación del audio secundario

Cuando pone “Audio Secundario” del “Menú de Configuración” en “Encender”, puede escuchar el audio de la imagen en imagen o de los comentarios de audio de los discos de Blu-ray compatibles con BD-LIVE. Consulte “Operaciones habituales” y “Audio Secundario” en la página 29 y en la página 31.

Control del reproductor de discos Blu-ray con la función de control HDMI™

Con la función de control HDMI, puede operar interactivamente este reproductor con su televisor (que soporte la función de control HDMI). Cuando conecte este reproductor con el televisor compatible con la función de control HDMI mediante un cable HDMI y ponga “Control HDMI” del “Menú de Configuración” en “Sí”, podrá utilizar la función que aparece más abajo. (Consulte la página 9 y la 33 en relación con la conexión con el terminal HDMI terminal y “Control HDMI”.)

- Función de selección de entrada automática
 Cuando inicie la reproducción en este reproductor, el selector de entrada del televisor (y de un receptor A/V si este reproductor esta conectado con el televisor mediante un receptor A/V) cambia automáticamente a este reproductor. Dependiendo del modelo del televisor, éste podría encenderse automáticamente.
- Función de apagado automático
 Cuando apague el TV cuando este reproductor esté en el modo de parada y no se visualice la pantalla del “Menú de configuración”, este reproductor también se apagará automáticamente.

Notas

- Es posible que la función de control HDMI no funcione correctamente dependiendo del televisor.
- Otras funciones, aparte de las que se han mencionado anteriormente, pueden funcionar según el televisor o receptor A/V.
- Para que la función de control HDMI esté disponible, ajuste la función de control HDMI en TODOS los componentes (este reproductor, televisor y receptor A/V). Se podrían necesitar diversas operaciones.
- Cada función se puede configurar de forma independiente para activar o desactivar según el televisor.
- Consulte los detalles relacionados con la configuración en los manuales de funcionamiento que se proporcionan con el televisor y/o el receptor A/V.

Reproducción de BD/DVD/CD

En esta sección se explica la reproducción de discos de venta en el comercio de vídeo BD y de vídeo DVD (p. ej. películas), discos compactos y discos grabados DVD-RW/R.

■ Para cargar un disco

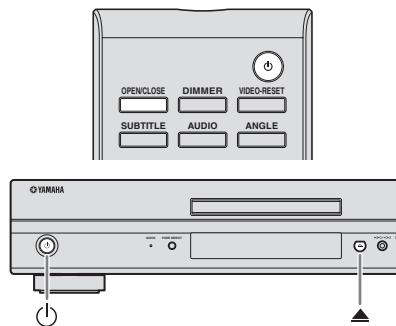

- ① Pulse para encender el aparato.
- ② Pulse **OPEN/CLOSE** o para abrir la bandeja portadiscos.
- ③ Cargue un disco en la bandeja portadiscos.
 - Inserte el disco con la etiqueta hacia arriba.
 - En el caso de un disco grabado de ambos lados, ponga boca abajo el lado que va a reproducir.

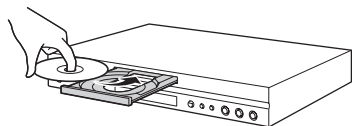

- ④ Pulse **OPEN/CLOSE** o para cerrar la bandeja portadiscos.

Notas

- La reproducción podría empezar automáticamente, según el disco.
- La reproducción comenzará desde el primer título.
- El menú podrá visualizarse primero, según el disco. Realice la operación de reproducción siguiendo las indicaciones en pantalla.
- El tiempo para cargar el disco puede variar dependiendo del disco.

■ Operaciones básicas de reproducción

BD-V **BD-RE** **BD-R**

DVD-V **DVD-R** **DVD-RW** **AUDIO CD**

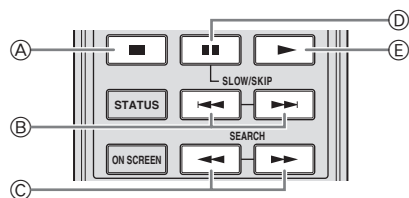

	Teclas	Funciones
(A)		Pausa o interrumpe la reproducción
(B)		Salta hacia adelante/atrás
(C)		Búsqueda hacia adelante/atrás (búsqueda) *1
(D)		Pausa la reproducción
(E)		Reproducción *2

*1 La velocidad de búsqueda cambiará cada vez que pulse el botón.

*2 El reproductor reanuda la reproducción desde el punto en el que se paró anteriormente el reproductor. Para reproducir desde el principio, pulse y después .

Notas

- Este reproductor permite el escalado del DVD durante la reproducción del mismo.
- Algunos de los discos de vídeo BD publicados recientemente no se pueden reproducir si no se actualiza el software de este reproductor a su última versión. Por lo tanto, podría ser necesario actualizar el software de este reproductor. Consulte más información en relación con las actualizaciones del software de este reproductor en la página 37.

Reproducción de avance de fotograma

La reproducción de avance de fotograma funciona cuando se pulsa durante la pausa.

Notas

- Es posible que la reproducción de avance de fotograma no funcione correctamente con discos que no sean DVD-RW/R (formato VR).
- Algunos discos de vídeo BD/DVD no son compatibles con la reproducción de avance de fotograma.
- La reproducción con avance/retroceso de fotograma se puede realizar para los discos DVD pulsando o durante la pausa.

Reproducción lenta

Las funciones de reproducción lenta funcionan cuando se pulsa o durante más de 2 segundos durante la pausa.

- Pulse para volver a la reproducción normal.

Notas

- Esto no funciona para los discos compactos de audio.
- La reproducción lenta con retroceso no se puede realizar para el vídeo BD.

■ Disfrute de sonido puro de alta fidelidad (función Pure Direct)

Este reproductor es compatible con el modo Pure Direct que le permite disfrutar de la salida de señales analógicas por las tomas de audio de 2 canales y por las tomas de audio de 8 canales discretos en sonido de alta fidelidad pura. Cuando el modo Pure Direct está activado, este reproductor reproducirá los discos con la menor circuitería.

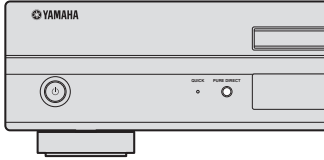

Pulse **PURE DIRECT** para activar y desactivar el modo Pure Direct.

- PURE DIRECT se enciende cuando se activa el modo Pure Direct.

Consejo

- El visor del panel delantero se apaga automáticamente, y el video analógico (componente, S-vídeo y vídeo) y el audio digital (óptico y coaxial) no salen mientras este reproductor esté en el modo Pure Direct.

■ Reproducción repetida

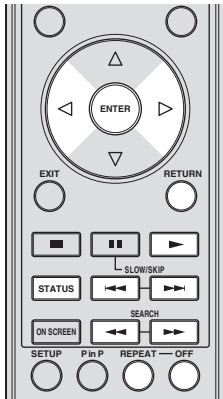

Reproducción repetida de un título o capítulo

- 1 Reproduzca el título o capítulo que quiera repetir.
- 2 Pulse **REPEAT**.
- 3 Pulse $\triangleleft/\triangleright$ para seleccionar el tipo de reproducción repetida.
 - Reproducción Título: Repite el título reproduciéndose actualmente.
 - Reproducción Capít: Repite el capítulo reproduciéndose actualmente.
 - Selección De Escena: Repite la escena especificada de título o capítulo.



- Pulse **RETURN** para cancelar sin configurar el tipo de reproducción repetida.
- Para los discos compactos de audio se puede seleccionar “Reproducción disco”, “Reproducción pista” y “Especificar parte” como opciones de la reproducción repetida.

- 4 Pulse **ENTER**.

Ejemplo: Reproducción repetida de un título (TÍTULO)

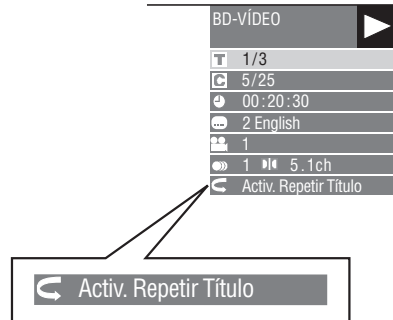

- 5 Pulse **OFF** para volver a la reproducción normal.

Reproducción repetida de una parte especificada

DVD-V **DVD-R** **DVD-RW** **AUDIO CD**

Nota

- Algunas de las operaciones de la siguiente función de reproducción no se pueden realizar dependiendo de las especificaciones del disco.

- 1 Pulse **REPEAT** durante la reproducción.
- 2 Pulse $\triangleleft/\triangleright$ para seleccionar “Selección De Escena” y, a continuación, pulse **ENTER**.
 - Se visualiza “Fijar Punto Inicio”.

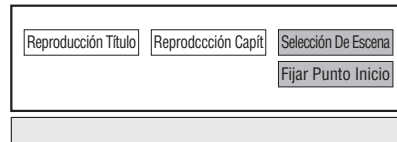

- 3 Pulse **ENTER** en la escena que desea configurar como punto de inicio.
 - Se visualiza “Fije Punto Fin”.
- 4 Pulse **ENTER** en la escena que desea configurar como punto final.
 - Puede pulsar $\triangleright\triangleright$ para avanzar rápido hasta la escena que desea configurar como punto final. Cuando llegue a la escena deseada, pulse simplemente \triangleright y después **ENTER** para configurar el punto final. Para cancelar la reproducción repetida, pulse **OFF**.

Notas

- Pulsando $\triangleright\triangleright$ se cancelará la reproducción repetida y se iniciará la reproducción del siguiente capítulo.
- Pulsando $\triangleleft\triangleleft$ una vez, se cancelará la reproducción repetida y el reproductor regresará al principio del capítulo (pista) actual.

- Si pulsa **◀◀** otra vez (antes de que pasen 5 segundos), el reproductor saltará al principio del capítulo (pista) anterior.
- Para la reproducción repetida de una parte especificada, configure los puntos de inicio y final dentro del mismo título.
- La reproducción repetida podría estar prohibida dependiendo del disco.
- La reproducción repetida de una parte especificada podría no funcionar en escenas con ángulos múltiples.
- Si pulsa **STATUS**, podrá confirmar el estado de la reproducción repetida.

■ Utilización de los menús BD/DVD

En esta sección se explica cómo reproducir un disco de vídeo BD/DVD con menú principal, menú del disco o menú emergente. En el menú del disco se ofrece el listado de títulos del menú de títulos y una guía del disco (para opciones como subtítulos e idiomas del audio).

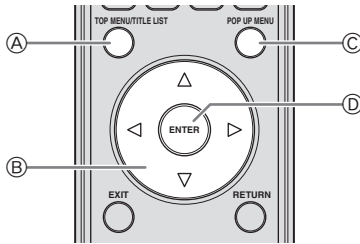

Teclas	Funciones	
Ⓐ	TOP MENU/ TITLE LIST	Muestra la pantalla del menú principal
Ⓑ	△ / ▽ / ◀ / ▶	Mueve la selección en la pantalla del menú
Ⓒ	POP UP MENU	Muestra la pantalla del menú emergente
Ⓓ	ENTER	Selecciona el elemento del menú seleccionado

Notas

- El procedimiento explicado en esta página es el procedimiento de operación básico. Los procedimientos variarán en función del disco de vídeo BD/DVD y por ello podría tener que seguir las instrucciones del manual del disco de vídeo BD/DVD o las instrucciones que se visualizan en la pantalla.
- En algunos discos BD/DVD, al menú principal se le denomina “Menú de títulos”. Emplee **TOP MENU/TITLE LIST** en el mando a distancia cuando en las instrucciones se refieran al “Menú de títulos”.
- La tecla **TOP MENU/TITLE LIST** no tendrá ningún efecto si no hay ningún menú principal disponible.
- La pantalla del menú principal se puede mostrar pulsando **POP UP MENU**, dependiendo del DVD.

Utilización del menú emergente

BD-V

- 1 Pulse **POP UP MENU** durante la reproducción.
 - Se visualiza la pantalla del menú emergente.
 - Los contenidos del menú que se visualiza varían en función del disco. Consulte los detalles sobre cómo ver y operar el menú emergente en el manual del disco.

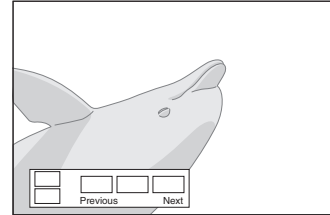

- 2 Pulse **△ / ▽ / ◀ / ▶** para seleccionar el elemento deseado y, a continuación pulse **ENTER**.
- 3 Pulse **POP UP MENU** para terminar.
 - En algunos discos, el menú emergente desaparecerá automáticamente.

■ Utilización del menú DVD-R/-RW

DVD-R DVD-RW

Puede reproducir un disco grabado (únicamente discos finalizado con formato VR).

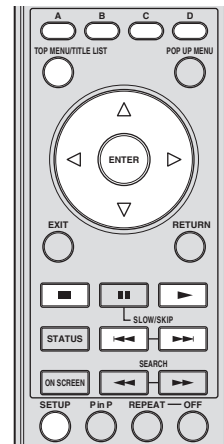

Nota

- “Finalizar” se refiere a una grabadora que procesa un disco grabado de forma que se reproducirá en otros reproductores/grabadoras de DVD y también en este reproductor. En este reproductor sólo se reproducirán discos DVD finalizados. (Este reproductor no tiene una función para finalizar discos.)

Reproducción seleccionando un título

- 1 Cargue un disco grabado.
 - Se visualizará la pantalla de Lista Títulos.

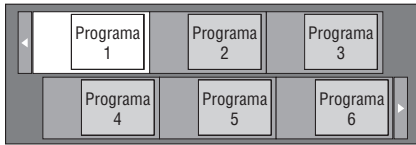

- Si no se visualiza la pantalla de lista de títulos, pulse **TOP MENU/TITLE LIST**.
- 2 Pulse Δ / ∇ / \triangleleft / \triangleright para seleccionar el título deseado y, a continuación pulse **ENTER**.
 - Cuando existan siete o más títulos, cambie de página pulsando $\triangleleft\triangleleft$ o $\triangleright\triangleright$.
 - Comenzará la reproducción del título seleccionado. Puede reproducir pulsando \blacktriangleright en vez de pulsar **ENTER**.
 - 3 Pulse \blacksquare para parar la reproducción.

Nota

- La pantalla de lista de títulos también se puede visualizar pulsando **TOP MENU/TITLE LIST** cuando la reproducción está detenida o pulsando **ENTER** después de seleccionar “Muestra lista de títulos” en el menú de configuración cuando la reproducción está detenida.

Acerca de la lista de títulos

- La lista de títulos se puede visualizar de dos formas: miniatura y lista de títulos.
- Cada vez que pulse **A**, la pantalla cambia entre miniatura y lista de títulos.

Miniatura

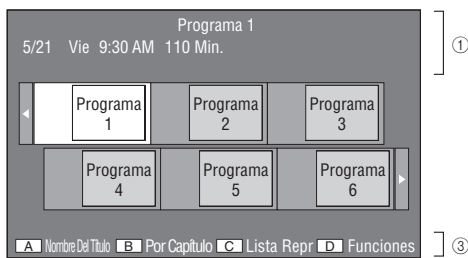

Lista de Título

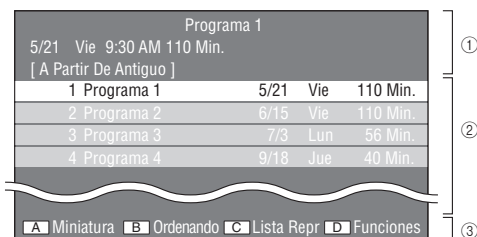

- 1 Información del título seleccionado
- 2 Nombre del título
Fecha de grabación
Duración de la grabación
- 3 Subtítulo para teclas de colores

Reproducción seleccionando un capítulo

- 1 Pulse **B** mientras se visualiza la pantalla de miniaturas.
 - Se visualizará la pantalla de capítulo.

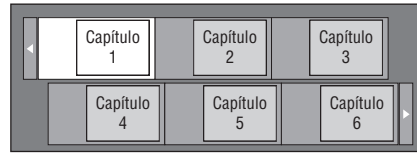

- Cuando haya siete capítulos o más, cambie de página pulsando $\triangleleft\triangleleft$ o $\triangleright\triangleright$.
 - Para regresar a la pantalla de miniaturas, pulse **B**.
- 2 Pulse Δ / ∇ / \triangleleft / \triangleright para seleccionar el capítulo deseado y, a continuación pulse **ENTER**.
 - Comenzará la reproducción del capítulo seleccionado. Puede reproducir pulsando \blacktriangleright en vez de pulsar **ENTER**.
 - 3 Pulse \blacksquare para parar la reproducción.

Ordenando los títulos

Cada vez que pulse **B** mientras se visualiza la pantalla de lista de títulos, dicha pantalla de lista de títulos cambia para mostrar primero el título más reciente o el título más antiguo.

Reproducción seleccionando una lista de reproducción

- 1 Pulse **C** mientras se visualiza la pantalla de miniaturas o la lista de títulos.
 - Se visualizará la pantalla Lista reproducción.

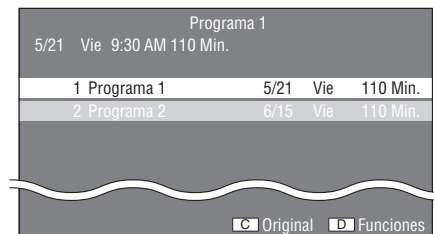

- 2 Pulse Δ / ∇ para seleccionar el título y, a continuación pulse **ENTER**.
 - Comenzará la reproducción del título seleccionado.
- 3 Pulse \blacksquare para parar la reproducción.

Reproducción del título que paró durante la reproducción

- 1 Pulse **D** mientras se visualiza la pantalla de miniaturas o la lista de títulos.

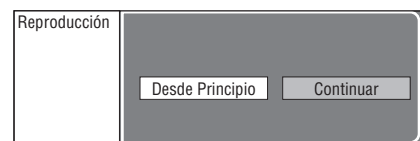

- 2 Pulse \triangleleft / \triangleright para seleccionar el tipo de reproducción y, a continuación pulse **ENTER**.
 - Comenzará la reproducción del título.
- 3 Pulse \blacksquare para parar la reproducción.

■ Utilización del menú de reproducción de CDs de audio

AUDIO CD

La siguiente pantalla se visualiza cuando se carga un CD de audio.



Nota

- La pantalla CD se visualiza únicamente cuando se inserta un disco compacto grabado en el formato CD-DA.

Reproducción seleccionando una pista

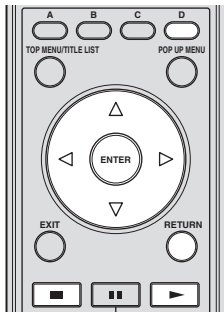

- 1 Pulse Δ / ∇ para seleccionar la pista y, a continuación, pulse **ENTER** durante la reproducción o cuando se detenga la misma.
 - Comenzará la reproducción de la pista seleccionada.

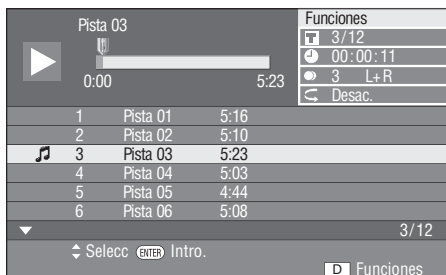

- 2 Pulse \blacksquare una vez para hacer una pausa en la reproducción (reanudar parada).
- 3 Vuelva a pulsar de nuevo \blacksquare para interrumpir completamente la reproducción.

Utilización del menú de funciones

- 1 Pulse **D** mientras se visualiza la pantalla de CD.

- Se activa el menú “Funciones”

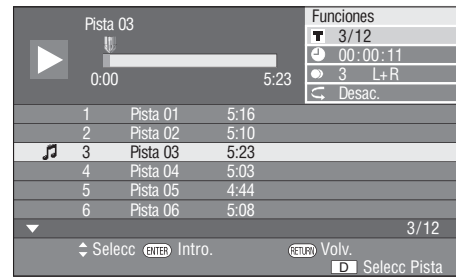

- 2 Pulse Δ / ∇ para seleccionar la configuración deseada y, a continuación pulse **ENTER**.
 - Cuando la reproducción está detenida, sólo se puede seleccionar “Pista”.
 - Para ver una descripción de cada configuración, consulte “Funciones que se pueden configurar” (página 26).
- 3 Pulse Δ / ∇ / \triangleleft / \triangleright para establecer la configuración y, después, **ENTER**.
 - Las operaciones pueden variar en función de la configuración. Realice la operación siguiendo las instrucciones de operación de la pantalla.
- 4 Pulse **RETURN** o **D** para salir del menú de funciones.

Nota

- Los elementos visualizados varían dependiendo del disco.

■ Disfrute de BONUSVIEW o BD-LIVE

BD-V

Este reproductor es compatible con funciones adicionales de vídeo BD, BONUSVIEW (BD-ROM Perfil 1 Versión 1.1) y BD-LIVE.

Para discos de vídeo BD compatibles con BONUSVIEW, están disponibles las funciones Imagen en Imagen y Paquete Virtual. Para discos compatibles con BD-LIVE, además de las funciones BONUSVIEW puede disfrutar de varias funciones a través de Internet.

Los datos de Paquete Virtual/BD-LIVE se guardan en almacenamiento local (dispositivo de memoria USB conectado a este reproductor). Para disfrutar de estas funciones, inserte un dispositivo de memoria USB (de 2 GB o más y formateado en FAT 32/16) que soporte USB 2.0 de alta velocidad (480 Mbit/s) en el puerto USB BD STORAGE/SERVICE (página 14) ubicado en la parte trasera de este reproductor.

- Si el espacio para almacenamiento es insuficiente, los datos no se copiarán/descargarán. Borre datos innecesarios o utilice un dispositivo de memoria USB nuevo.
- Si se utiliza un dispositivo de memoria USB que contiene otros datos (grabados previamente), puede ser que el vídeo y el audio no se reproduzcan correctamente.
- Si el dispositivo de memoria USB se desconecta del reproductor durante la reproducción de datos de Paquete Virtual/BD-LIVE, la reproducción del disco se interrumpirá.
- Puede requerirse algún tiempo para que se carguen (lectura/escritura) los datos.
- Consulte “Manejo De Memoria USB” en la página 36 para borrar los datos de Paquete Virtual y de BD-LIVE del dispositivo de memoria USB.

Notas

- Yamaha no puede garantizar que todas las marcas de dispositivos de memoria USB funcionen con este reproductor.
- No utilice un cable alargador USB cuando conecte un dispositivo de memoria USB en el puerto USB BD STORAGE/SERVICE del reproductor. El uso de un cable alargador USB puede prevenir que el reproductor funcione correctamente.

Utilización de la función Imagen en Imagen (reproducción de audio/vídeo secundario)

El vídeo BD que incluye audio y vídeo secundario compatible con Imagen en Imagen se puede reproducir con audio y vídeo secundario simultáneamente como un vídeo pequeño en la esquina.

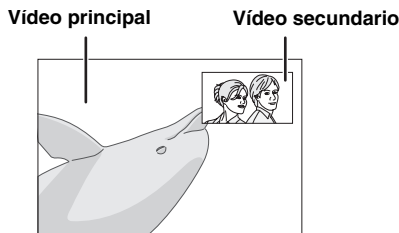

Pulse **P in P** para activar o desactivar la función de Imagen en Imagen.

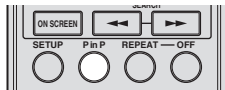
**Notas**

- Para escuchar el audio secundario, asegúrese de que “Audio Secundario” está en “Encender”. (Consulte la página 31.)
- Dependiendo del contenido, el audio y el vídeo secundario para Imagen en Imagen pudiera reproducirse y desaparecer automáticamente. Además, pudiera haber restricción respecto a las áreas que pueden visualizarse.

Paquete Virtual

Para discos de vídeo BD compatibles con Paquete Virtual, los datos se copian desde discos o Internet al almacenamiento local. Se copian automáticamente al almacenamiento local antes de la reproducción. Puede disfrutar de diversas funciones adicionales, entre ellas, vídeo secundario, audio secundario, subtítulos, trailers de películas, etc.

- Los métodos de reproducción varían en función del disco. Para los detalles, consulte el manual del disco.

BD-LIVE

En este reproductor, se puede disfrutar de contenido variado con funciones Interactivas mediante discos Blu-ray compatibles con BD-LIVE y una conexión a Internet. Puede disfrutar de la descarga de contenido adicional, como trailers de películas más recientes, al dispositivo de memoria USB, juegos interactivos BD-J compatibles con comunicación, etc.

- Las funciones disponibles difieren dependiendo del disco.

- Los contenidos y los métodos de funcionamiento de BD-LIVE varían en función de los programas que se proporcionan por Internet. Siga las indicaciones en pantalla para operar.

Notas

- En relación con el método de reproducción de contenidos BD-LIVE, etc., lleve a cabo las operaciones de acuerdo con las instrucciones del manual del disco BD.
- Para disfrutar de las funciones BD-LIVE, realice la conexión a Internet de banda ancha (página 14) y los ajustes de comunicación (páginas 34–36).
- Consulte la página 33 en relación con la configuración para restringir el acceso a contenidos BD-LIVE.
- El tiempo que se necesita para descargar los programas que se ofrecen al dispositivo de memoria USB conectado en este reproductor depende de las velocidades de conexión a Internet y del volumen de datos de los programas.
- Los programas de BD-LIVE que se ofrecen por Internet podrían no ser capaces de mostrar la conexión en función del estado (actualizando) del proveedor. En tales casos, extraiga el disco e inténtelo de nuevo.
- Si la pantalla de BD-LIVE no aparece breve tiempo después de seleccionar la función BD-LIVE en el menú del disco BD, es posible que el dispositivo de memoria USB no tenga suficiente espacio libre. En tales casos, extraiga el disco del reproductor y borre entonces los datos del dispositivo de memoria USB utilizando el menú de borrado de datos del menú “Manejo De Memoria USB”. (Consulte la página 36 del manual de instrucciones.)

■ Pantalla de control de funciones

Esto le permite hacer varios ajustes al instante, como ajuste de subtítulos y ángulo, y selección de título para reproducción directa. Dependiendo de sus preferencias, podrá ajustar el vídeo y el audio. La operación es igual para BD y DVD.

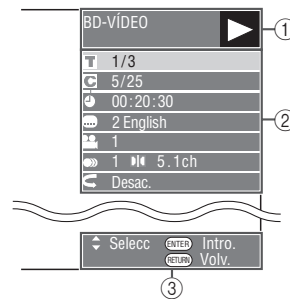
Pantalla de control de funciones**① Visualización del estado de la reproducción**

Muestra el estado de operación y el tipo de disco.

② Elementos de ajuste

Selecciona un título (o pista) o capítulo para reproducir, o realiza ajustes de vídeo/audio.

③ Visualización de la guía de operación

Ofrece ayuda sobre las operaciones con las teclas del mando a distancia.

Procedimiento para el control de las funciones

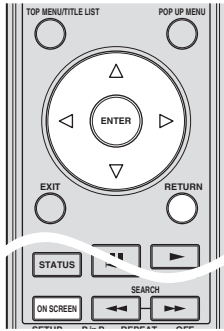

- ① Pulse **ON SCREEN** durante la reproducción.
 - Se visualiza la pantalla de control de funciones en el televisor.
- ② Pulse Δ / ∇ para seleccionar la configuración deseada y, a continuación pulse **ENTER**.
 - Para ver una descripción de cada configuración, consulte “Funciones que se pueden configurar” (página 26).

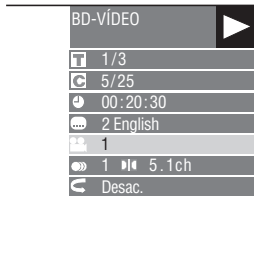

- ③ Pulse Δ / ∇ / \triangleleft / \triangleright para establecer la configuración y, después, **ENTER**.
 - Las operaciones pueden variar en función de la configuración. Realice la operación siguiendo las instrucciones de operación de la pantalla.
- ④ Pulse **RETURN** o **ON SCREEN** para cerrar la pantalla de control de funciones.

Notas

- Si se visualiza “- -” para una opción como número de título o subtítulos, el disco no tiene títulos o subtítulos que se puedan seleccionar.
- Los elementos visualizados varían dependiendo del disco
- Si accede a la pantalla de control de funciones durante la reproducción de un vídeo BD/DVD, podría resultar imposible reproducir vídeos BD/DVD. En casos como este, cierre la pantalla de control de funciones.

Funciones que se pueden configurar

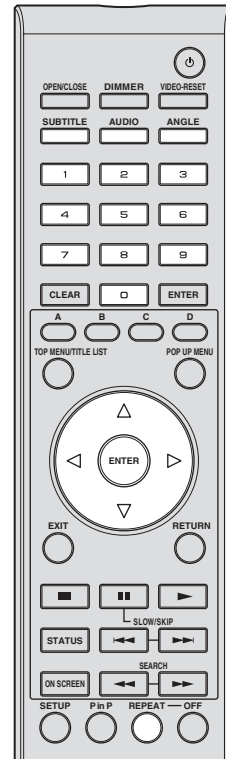

Iconos	Funciones	Descripciones
	Número de título/pista (Salto de título/pista directo)	<ul style="list-style-type: none"> – Muestra el número del título reproduciéndose (o el número de pista cuando se reproduce un audio CD). Usted podrá saltar hasta el principio del título (o pista). – Para saltar al principio del título (o pista) seleccionado, pulse las teclas de Número para introducir el número del título (o pista) cuando esta opción está iluminada.
	Número de capítulo (Salto de capítulo directo)	<ul style="list-style-type: none"> – Muestra el número del capítulo que se está reproduciendo. Usted podrá saltar hasta el principio del capítulo. – Para saltar al principio del capítulo seleccionado, pulse las teclas de Número para introducir el número del capítulo cuando esta opción está iluminada.
	Tiempo transcurrido de reproducción (Salto de tiempo directo)	<ul style="list-style-type: none"> – Muestra el tiempo transcurrido desde el principio del título de disco (o pista) actual. Esto le permite saltar a un momento específico. – Pulse \triangleleft / \triangleright para seleccionar hora, minuto o segundo y, a continuación, pulse Δ / ∇ o las teclas de Número para configurar el momento. Pulse ENTER para iniciar la reproducción en el momento establecido.

Iconos	Funciones	Descripciones
	Idioma de subtítulo	– Muestra el idioma del subtítulo seleccionado actualmente. Si hay subtítulos provistos en otros idiomas, podrá cambiar a su idioma preferido. También puede seleccionar el idioma de los subtítulos pulsando SUBTITLE .
	Número de ángulo	– Muestra el número de ángulo seleccionado actualmente. Si el vídeo está grabado con múltiples ángulos, podrá cambiar el ángulo. También puede cambiar el ángulo pulsando ANGLE .
	Audio	– Muestra el tipo de audio seleccionado actualmente. Usted podrá seleccionar el tipo de audio deseado. También puede seleccionar el tipo de audio pulsando AUDIO .
	Repetir	– Puede reproducirse repetidamente el título (o capítulo) actual o segmentos parciales. La reproducción repetida también es posible con la tecla REPEAT del mando a distancia.

Notas

- Puede que estas funciones no se ejecuten en todos los discos.
- Para DVD-RW y DVD-R, cuando se reproduce un emisión grabada con audio en estéreo o en mono, se visualiza “Estéreo”. (El audio no se puede alternar.)
- Cuando reproduzca un programa grabado en sonido estéreo o monofónico, y si está escuchando el sonido Bitstream a través de la toma de salida digital, no podrá seleccionar el canal de audio. Ponga “Salida De Audio” en “PCM” (Página 31) o, si quiere cambiar el canal de audio, escuche a través de las tomas de salida analógica.

Visualización de la información del disco

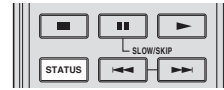

Pulse **STATUS** durante la reproducción.

- Cada vez que pulse **STATUS**, la visualización cambiará de la siguiente forma.

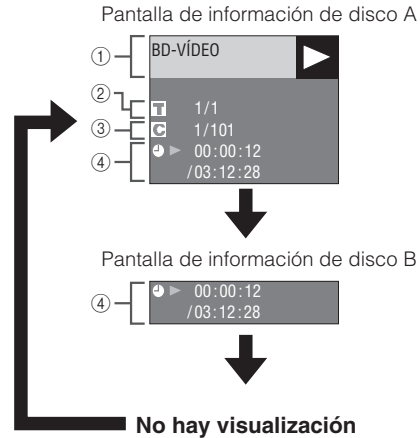

- ① Tipo de disco
- ② Número del título reproduciéndose / Número total de títulos
- ③ Número del capítulo reproduciéndose / Número total de capítulos
- ④ Tiempo transcurrido de reproducción / Tiempo de reproducción total para el título

Notas

- La pantalla de Información de disco A desaparece después que transcurra aproximadamente 1 minuto sin realizarse ninguna operación.
- Para algunos discos de vídeo BD lanzados comercialmente, puede que no aparezca la visualización del tiempo de reproducción total para el capítulo/título.

Reproducción de archivos JPEG

CD-R JPEG CD-RW JPEG

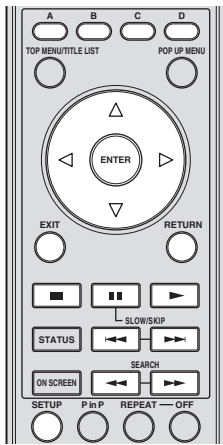

Notas

- Este reproductor puede reproducir imágenes fijas (archivos JPEG) que han sido grabados en CD-RW/R discos. Remítase a "Acerca del formato de archivo JPEG" en la página 3 para obtener más información sobre las imágenes fijas que se pueden reproducir con este reproductor.
- Durante la "Reproducción normal", las imágenes fijas se reproducen una a una y, durante "Presentación de Diapositivas", cambian de una a otra de forma automática.

■ Cómo reproducir Imágenes fijas en secuencia

Cargue el disco que contiene las imágenes fijas y pulse

- La primera imagen fija aparece en la pantalla.
- Pulse \lll o \ggg para pasar a la siguiente o la anterior imagen fija.
- La misma operación se puede realizar pulsando $\triangleleft / \triangleright$ o \lll o \ggg .

■ Reproducción de las imágenes fijas de una carpeta determinada

- ① Cargue el disco que contiene las imágenes fijas y pulse **SETUP**.
- ② Pulse $\triangle / \nabla / \triangleleft / \triangleright$ para seleccionar "Imagen" y, a continuación, pulse **ENTER**.
- ③ Utilice $\triangle / \nabla / \triangleleft / \triangleright$ para seleccionar la carpeta que contiene las imágenes que se van a reproducir y, a continuación, pulse **ENTER**.

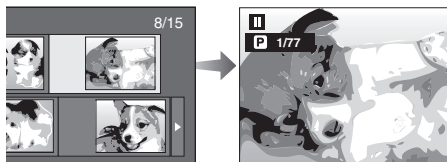

- ④ Pulse \lll o \ggg para reemplazar una imagen por otra.
 - La misma operación se puede realizar pulsando $\triangleleft / \triangleright$ o \lll o \ggg .
 - Pulse **RETURN** si desea volver a la pantalla de selección de carpetas.
- ⑤ Pulse \blacksquare para interrumpir la reproducción de imágenes fijas en cualquier momento.

■ Reproducción de Presentación de Diapositivas

- ① En el paso 2 de la parte izquierda de "Reproducción de las imágenes fijas de una carpeta determinada", pulse \blacktriangleright (Presentación de diapositivas).
 - Las Imágenes fijas dentro de la carpeta seleccionada se reproducen en modo de presentación.
- ② Pulse \blacksquare para hacer una pausa en cualquier momento de la reproducción.
 - Pulse \blacktriangleright para reanudar la reproducción.
- ③ Pulse \blacksquare para interrumpir la reproducción en cualquier momento.
 - Pulse **RETURN** para reproducir una presentación de las imágenes fijas de otra carpeta.

■ Configuración de la velocidad de la presentación de diapositivas/ reproducción repetida

- ① Pulse **C** (Menú presentación de diapositivas) durante la pantalla de selección de carpetas.
 - Aparecerá la pantalla de configuración de "Vel. Present. Diapos."/"Ajus. Modo Repetición".
- ② Pulse \triangle / ∇ para seleccionar "Vel. Present. Diapos." y, a continuación, pulse **ENTER**.

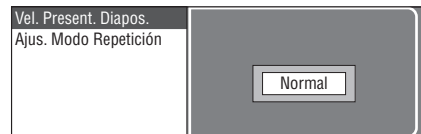

- ③ Pulse \triangle / ∇ para seleccionar la velocidad deseada y, a continuación, pulse **ENTER**.
 - La velocidad de la presentación de diapositivas se pueden seleccionar entre "Rápido", "Normal" "Lento1" y "Lento2".
- ④ Pulse \triangle / ∇ para seleccionar "Ajus. Modo Repetición" y, a continuación, pulse **ENTER**.

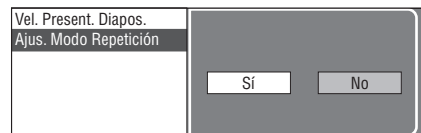

- ⑤ Pulse $\triangleleft / \triangleright$ para seleccionar el elemento deseado y, a continuación, pulse **ENTER**.
- ⑥ Pulse **EXIT** para terminar.

Ajustes

El “Menú” permite realizar diversos ajustes y configuraciones audiovisuales en las funciones utilizando el mando a distancia.

Menú/Submenú	Función	Página	
Ajustes De Audio Vídeo	Relación Aspecto TV	Ajusta la relación de aspecto de la pantalla del televisor conectado, y ajusta la salida de vídeo.	30
	Salida De Vídeo Componente	Ajusta la resolución de la salida de vídeo componente.	30
	Salida De Vídeo HDMI	Ajusta la resolución de la salida de vídeo HDMI.	31
	Selección Salida De Vídeo	Selecciona la prioridad de la salida de vídeo.	31
	Audio Secundario	Configura el audio de la imagen en imagen o de los comentarios de audio.	31
	Salida De Audio	Ajusta la salida de audio adecuada para su entorno de reproducción.	31
	Control Gama Dinámica	Ajusta la gama dinámica para la reproducción a un volumen intermedio.	32
Configuración de los altavoces	Configura los altavoces conectados con este reproductor por los terminales de 8 canales discretos.	32	
Inicio Rápido	Configura el tiempo de arranque de este reproductor para que sea reducido.	33	
Apagado Automático	Ajuste para que este reproductor se apague automáticamente.	33	
Control HDMI	Configura este reproductor para que reciba la señal de control desde el mando a distancia de su televisor.	33	
Ajustes De La Reproducción	Control Paterno	Establece el control paterno en función del contenido del disco.	33
	Idioma del disco	Selecciona el idioma para los subtítulos, el audio y los menús que se visualizan en la pantalla.	33
	Visul. Marca Ángulo	Ajuste para mostrar la marca de ángulo cuando se reproducen BD/DVD con ángulos múltiples.	33
	Ajuste De Contraseña	Establece la contraseña.	33
	Acceso A BD Internet	Establece restricciones de acceso a los contenidos BD-LIVE.	33
Configuración De Comunicaciones	Cambia los ajustes de la comunicación.	34	
Versión	Muestra la versión del software del sistema.	34	
Manejo De Memoria USB	Borra datos de la memoria USB.	36	
Actualiz. Software	Actualiza el software de este reproductor.	17, 37	
Reinicio Sistema	Reestablece todos los ajustes a los preajustes de fábrica.	34	

Operaciones habituales

Necesita acceder a la pantalla del menú de configuración para realizar los ajustes de este reproductor. A continuación se ofrece la explicación de las operaciones básicas del “Menú”.

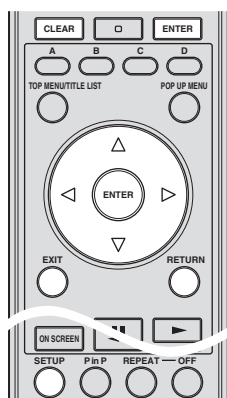

Ejemplo: Para configurar “Apagado Automático”

1. Visualice la pantalla del menú

Pulse **SETUP** para visualizar la pantalla del menú de configuración.
Pulse Δ / ∇ / \triangleleft / \triangleright para seleccionar “Ajustes” y, a continuación, pulse **ENTER**.



2. Seleccione un elemento del menú

Pulse Δ / ∇ para seleccionar “Apagado Automático” y, a continuación, pulse **ENTER**.

Ajustes De Audio Vídeo
Configuración de los altavoces
Inicio Rápido
Apagado Automático
Control HDMI
Ajustes De La Reproducción
Configuración De Comunicaciones
Versión
Manejo De Memoria USB
Actualiz. Software
Reinicio Sistema

3. Seleccione el elemento siguiente

Pulse $\triangleleft/\triangleright$ para seleccionar el elemento deseado y, a continuación pulse **ENTER**.



Pulse **RETURN** para volver a la página anterior del "Menú".

4. Salga de la pantalla del menú

Pulse **SETUP** o **EXIT** para terminar.

Ejemplo de funcionamiento del menú de configuración

Ejemplo: Configuración "Control Paterno" en "Ajustes De La Reproducción"

- 1 Pulse **SETUP** para visualizar la pantalla del menú de configuración.
- 2 Pulse $\triangleleft/\triangleright/\triangle/\nabla$ para seleccionar "Ajustes" y, a continuación, pulse **ENTER**.
- 3 Pulse $\triangleleft/\triangleright/\triangle/\nabla$ para seleccionar "Ajustes De La Reproducción" y, a continuación, pulse **ENTER**.
- 4 Pulse $\triangleleft/\triangleright/\triangle/\nabla$ para seleccionar "Control Paterno" y, a continuación, pulse **ENTER**.
 - Cuando utilice este reproductor por primera vez, se visualizará la pantalla de establecimiento de la contraseña. Consulte más abajo "Cuando se establece la contraseña por primera vez".
- 5 Introduzca su contraseña de 4 dígitos.
 - No puede ir a la siguiente pantalla de configuración hasta que no haya introducido la contraseña correcta.

Cuando se establece la contraseña por primera vez.

1. Para establecer la contraseña por primera vez, pulse $\triangleleft/\triangleright$ para seleccionar "Sí" y acceder al menú de configuración de la contraseña y, después, pulse **ENTER**.
2. Introduzca un número de 4 dígitos para la contraseña y, después, confirme la contraseña introduciendo el mismo número de 4 dígitos.
3. Pulse **ENTER** para completar el procedimiento de ajuste de la contraseña y pasar a la siguiente pantalla de configuración.

Consejos

- Puede borrar la cifra de 4 dígitos pulsando **CLEAR**.

- Puede utilizar **ENTER** en la parte inferior derecha de las teclas **Numéricas** en vez de **ENTER** en las teclas de **Cursor**.

- 6 Pulse $\triangleleft/\triangleright$ para seleccionar el nivel de control paterno para DVD VIDEO y BD-ROM y, a continuación, seleccione el código de país. Pulse **ENTER** después de realizar cada selección.

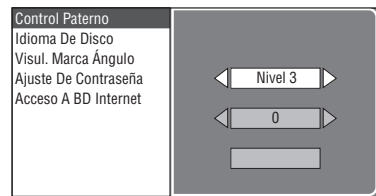

- 7 Pulse **SETUP** o **EXIT** para terminar.

Ajustes De Audio Vídeo

Consejo

- Los ajustes predeterminados están marcados con "i*"

Relación Aspecto TV

Puede ajustar la relación de aspecto de la pantalla del televisor conectado, y ajustar la salida de vídeo. Si cambia de televisor, por ejemplo, porque ha adquirido uno nuevo, y la relación de aspecto de la pantalla del televisor conectado cambia, también tendrá que cambiar el ajuste "Relación Aspecto TV".

Panor. 16:9*: Seleccione esta opción cuando conecte con un televisor con una relación de aspecto de pantalla de 16:9.

Normal 4:3: Seleccione esta opción cuando conecte con un televisor con una relación de aspecto de pantalla de 4:3.

Cuando se selecciona Normal 4:3

Buzón*: Si reproduce un DVD con vídeo de 16:9, el vídeo se reproducirá con bandas negras en las partes superior e inferior mientras se mantiene la relación 16:9.

Expl. Panor.: Si reproduce un DVD con vídeo de 16:9, el vídeo se reproducirá con los lados izquierdo y derecho de la imagen cortados para su visualización en una relación de aspecto de pantalla de 4:3. (Esta función funciona si el disco tiene la etiqueta 4:3PS).

Salida De Vídeo Componente

Esto ajusta la resolución de la salida de vídeo componente. Algunos televisores no son totalmente compatibles con el reproductor de disco Blu-ray y ello puede producir distorsión de la imagen. En tal caso, pulse **VIDEO-RESET** en el mando a distancia durante cinco segundos. "Salida De Vídeo Componente" se volverá a poner en "480i" (valor preajustado de fábrica).

1080i, 720p, 480p, 480i*

Nota

- Algunos discos prohíben la salida de vídeo de alta definición desde las tomas COMPONENT. En tal caso, la resolución de vídeo se convierte a 480p o 480i.

Salida De Vídeo HDMI

Aquí se ajusta la resolución de la salida de vídeo HDMI. Algunos televisores no son totalmente compatibles con el reproductor de disco Blu-ray y ello puede producir distorsión de la imagen. En tal caso, pulse **VIDEO-RESET** en el mando a distancia durante cinco segundos. "Salida De Vídeo HDMI" se volverá a poner en "Auto" (valor preajustado de fábrica).

Auto*, 1080p, 1080i, 720p, 480p

Nota

- Cuando el reproductor BD esté conectado con un televisor compatible con 1080p 24Hz y la "Salida De Vídeo HDMI" esté ajustada en "Auto", se visualizará automáticamente 1080p 24Hz cuando se reproduzcan discos compatibles.
A 1080p 24Hz o 1080p 60Hz, no hay salida desde las tomas COMPONENT y el terminal VIDEO.

Selección Salida De Vídeo

Es posible tener doble salida de vídeo simultáneamente desde las tomas de vídeo analógico (componente, S-vídeo y vídeo) y el terminal HDMI OUT con las siguientes configuraciones. Seleccione la salida de vídeo que desea que tenga prioridad de acuerdo con la siguiente guía.

HDMI*: Seleccione esta opción para dar prioridad a la salida HDMI. Puede establecer la resolución de la salida de vídeo HDMI en "Ajustes" - "Ajustes De Audio Vídeo" - "Salida De Vídeo HDMI". (Consulte la página 31.)

Componente: Seleccione esta opción para dar prioridad a la salida analógica (componente, S-vídeo y vídeo). Puede establecer la resolución de la salida de vídeo componente en "Ajustes" - "Ajustes De Audio Vídeo" - "Salida De Vídeo HDMI". (Consulte la página 30.)

Notas

- 1080p sólo está disponible en HDMI.

Ajustes en este reproductor		Resolución de salida	
Selección Salida De Vídeo	Salida De Vídeo HDMI	Salida de componente	Salida S/ CVBS
HDMI	Auto	*1 *2	480i *3
	1080p	Sin salida	Sin salida
	1080i	1080i *1	480i
	720p	720p *1	480i
	480p	480p *1	480i

Ajustes en este reproductor		Resolución de salida	
Selección Salida De Vídeo	Salida De Vídeo Componente	Salida HDMI	Salida S/ CVBS
Componente	1080i *1	1080i *1	480i
	720p *1	720p *1	480i
	480p	480p	480i
	480i	480i	480i



*1 Algunos discos prohíben la salida de vídeo de alta definición desde las tomas COMPONENT. En tal caso, la resolución de vídeo se convierte a 480p (cuando "Selección Salida De Vídeo" está en "Componente") o 480i (cuando "Selección Salida De Vídeo" está en "HDMI").

*2 Depende del televisor conectado. No hay salida de vídeo cuando desde el terminal HDMI salen señales de 1080p.

*3 No hay salida de vídeo cuando desde el terminal HDMI salen señales de 1080p.

- Si el equipo de vídeo conectado en cada uno de los terminales no es compatible con la resolución de la salida de vídeo con prioridad, pueden aparecer anomalías en las imágenes de la pantalla.

Consejo

- Esta función también se puede realizar con las teclas del panel delantero. Pulse y mantenga pulsado  y  en el panel delantero (o pulse y mantenga pulsado **DIMMER** en el mando a distancia) durante más de 4 segundos cuando en este reproductor no se haya introducido un disco y la bandeja portadiscos esté cerrada.

Audio Secundario

Puede activar y desactivar el audio de la imagen en imagen o de los comentarios de audio.

- Seleccione "Encender" para dar salida al audio de la imagen en imagen.
- Seleccione "Apagar" para disfrutar de los sonidos de alta calidad de un vídeo BD.

Consejo

- Cuando ponga "Audio Secundario" en "Apagar", esta unidad no da salida al sonido clic del menú.

Encender, Apagar*

Salida De Audio

Puede ajustar la salida de audio adecuada para su entorno de reproducción.

- ① Seleccione la salida de audio conectada con un televisor o receptor A/V.

Salida De HDMI*: Seleccione esta opción cuando se conecte utilizando un terminal HDMI.

Salida Digital: Seleccione esta opción cuando se conecte utilizando un terminal DIGITAL OUT (COAXIAL/OPTICAL).

Salida Audio 7.1ch: Seleccione esta opción cuando se conecte utilizando los terminales AUDIO OUT (8 canales discretos).

Salida Audio 2ch: Seleccione esta opción cuando no utilice equipo de sonido SURROUND.

- ② Seleccione el modo de salida.

Cuando haya seleccionado "Salida De HDMI"

Serie de bits*:

- Seleccione esta opción cuando conecte con el equipo HDMI con un descodificador incorporado para DOLBY DIGITAL, etc.
- El ajuste en serie de bits dará salida a cada señal de audio mediante serie de bits.

PCM (Envolvente):– Seleccione esta opción cuando la conexión sea con un equipo HDMI multicanal (sin un descodificador incorporado para DOLBY DIGITAL, etc.) o un equipo HDMI de 2 canales, por ejemplo, un televisor.

- El ajuste en PCM (Envolvente) dará salida mediante PCM LINEAL descodificando las señales de audio grabadas en cada modo de salida de audio como DOLBY DIGITAL, DTS.

Nota

- Cuando el "Audio Secundario" esté en "Encender", PCM se selecciona automáticamente como el modo de salida de audio.

Cuando haya seleccionado "Salida Digital"

- Serie de bits*:**
- Seleccione esta opción cuando la conexión sea con un equipo SURROUND con un descodificador incorporado para DOLBY DIGITAL, etc.
 - El ajuste en serie de bits dará salida a cada señal de audio mediante serie de bits.
- PCM:**
- Seleccione esta opción al conectar con un equipo de audio estéreo con 2 canales.
 - El ajuste en PCM dará salida convirtiendo cada señal de audio en señal de audio PCM de 2 canales.

Nota

- Consulte la información sobre los formatos de salida de audio en la página 38.

Control Gama Dinámica

Esta opción le permite ajustar la gama entre los sonidos más alto y más bajo (gama dinámica) para reproducir a un volumen intermedio. Emplee esta opción cueste escuchar los diálogos.

- Normal:** La gama de salida de audio que se reproduce es igual que la gama de salida del audio grabado original.
- Cambiar:** Cuando se reproduce audio Dolby Digital, la gama dinámica del audio se ajusta para que se pueda oír fácilmente la parte de diálogo. (Si el audio suena anómalo, ponga el ajuste en "Normal".)
- Auto*:** Cuando reproduce audio en el formato Dolby TrueHD, la gama dinámica se ajusta automáticamente.

* Baje el volumen antes de ajustar. Si no lo hace, los altavoces podrían emitir un sonido a elevado volumen o se podría aplicar una salida excesiva en los altavoces.

Configuración de los altavoces

Esta opción configura el tamaño, distancia y niveles de volumen, individualmente para cada altavoz, cuando la conexión utiliza las tomas AUDIO OUT (8 canales discretos).

- 1 Pulse **SETUP** para visualizar la pantalla del menú de configuración.
- 2 Pulse $\Delta / \nabla / \triangleleft / \triangleright$ para seleccionar "Ajustes" y, a continuación, pulse **ENTER**.
- 3 Pulse Δ / ∇ para seleccionar "Configuración de los altavoces" y, a continuación, pulse **ENTER**.
- 4 Pulse $\triangleleft / \triangleright$ para seleccionar "Sí" y, a continuación, pulse **ENTER**.
 - Seleccione "No" para cancelar sin configurar Configuración de los altavoces.

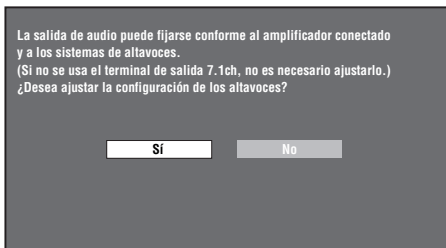

- 5 Pulse $\Delta / \nabla / \triangleleft / \triangleright$ para seleccionar el altavoz que desea configurar y, a continuación, pulse **ENTER**. **L** (delantero izquierdo), **C** (central), **R** (delantero derecho), **RS** (surround derecho), **RB** (surround trasero derecho), **LB** (surround trasero izquierdo), **LS** (surround izquierdo), **SW** (subwoofer)

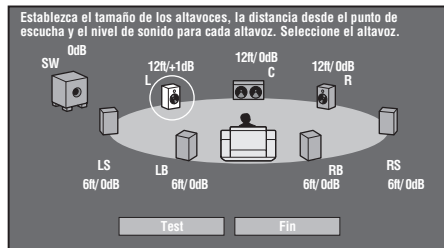

- 6 Pulse $\triangleleft / \triangleright$ para seleccionar "Tamaño", "Distancia" y "Nivel" y, después, pulse Δ / ∇ para establecer el valor del elemento seleccionado.

- Tamaño:** Puede elegir entre los tamaños "Menos", "Más" y "No".
- Distancia:** Puede establecer las distancias eligiendo entre "0.3m (1 ft)" - "3.0m (10 ft)*" - "9m (29 ft)".
- Nivel:** Puede establecer los niveles de volumen desde "-12 dB" hasta "0 dB*".

Notas

- Cuando "SW" se ponga en "No", los altavoces no se podrán poner en "Menos".

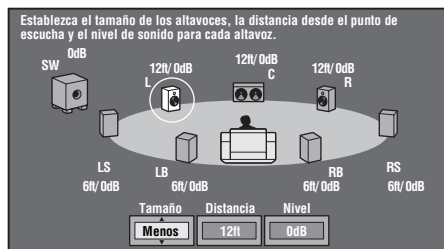

- Para configurar los otros elementos, repita el paso 6.
 - Para configurar los otros altavoces, repita los pasos 5 a 6.
- 7 Pulse ∇ para seleccionar "Test" y, a continuación, pulse **ENTER**. El tono de prueba sale de cada uno de los altavoces para ayudarle a juzgar los niveles de volumen.
 - 8 Pulse ∇ para seleccionar "Tono Test Stop" y, a continuación, pulse **ENTER**. El tono de prueba se para.
 - 9 Pulse \triangleright para seleccionar "Fin" y, a continuación, pulse **ENTER**.

■ Inicio Rápido

Aquí se activa y desactiva la función de inicio rápido. Cuando la función de inicio rápido está activada:

- El tiempo de arranque del reproductor se reduce.
- Pero, sin embargo, se incrementará el consumo.
- Se ilumina el indicador QUICK.

Cuando la función de inicio rápido está desactivada:

- El reproductor entrará en el modo de bajo consumo de energía cuando esté en la condición en espera.

Sí, No*

Nota

- Cuando “Inicio Rápido” está ajustado en “Sí”, el reproductor necesita cierto tiempo para apagarse.

■ Apagado Automático

Esto ajusta el reproductor de forma que la alimentación se apague automáticamente si se para la reproducción durante aproximadamente 10 minutos

Sí, No*

■ Control HDMI

Esto le permite configurar el reproductor para que reciba la señal de control del mando a distancia del TV compatible con la función de control HDMI mediante el cable HDMI.

Sí, No*

Notas

- Consulte los detalles en “Control del reproductor de discos Blu-ray con la función de control HDMI” (página 18) y el manual de instrucciones del receptor A/V y del televisor.
- La función de control HDMI no está disponible si en “Selección Salida De Vídeo” se ha seleccionado “Componente”. Seleccione “HDMI” si desea utilizar las funciones de control HDMI.

■ Ajustes De La Reproducción

Control Paterno

En algunas emisiones digitales y discos de vídeo BD/DVD existe un nivel de control para la visualización del disco en función de la edad del espectador. Esto le permite ajustar el control paterno en función del contenido del disco. A continuación se muestran los niveles de control paterno disponibles.

Hay que introducir la contraseña de 4 dígitos antes de configurar los niveles de control paterno y el código del país. Los niveles de control paterno y el código del país no se pueden configurar si no se ha creado o no se ha introducido la contraseña.

Para DVD de vídeo

8 y Apagado*: Se pueden reproducir todos los DVD de vídeo.

1-7: Prohíbe la reproducción de DVD de vídeo que contengan grabadas las clasificaciones correspondientes.

Para BD-ROM

Sin Límite*: Se pueden reproducir todos los vídeos BD.

0-99 años(s): Prohíbe la reproducción de vídeos BD que contengan grabadas las clasificaciones correspondientes.

Código del país

Ajusta el código de país. Consulte la lista de códigos de país (página 38) porque las clasificaciones varían en función del país.

Nota

- Consulte los detalles en “Ejemplo de funcionamiento del menú de configuración” (página 30).

Idioma De Disco

Esto le permite seleccionar el idioma para los subtítulos, el audio y los menús visualizados en la pantalla.

Subtítulo

Consulte la lista de idiomas. (página 38)

Audio

Consulte la lista de idiomas. (página 38)

Menú

Consulte la lista de idiomas y la lista de códigos de idiomas. (página 38)

Visul. Marca Ángulo

Esto le permite encender y apagar la visualización de marcas de ángulo cuando se reproduce un vídeo BD/DVD grabado con ángulos múltiples. (Se visualiza la marca del ángulo en la parte inferior derecha de la pantalla.)

Sí, No*

Ajuste De Contraseña

Esta opción configura la contraseña para ajustar o cambiar el nivel de control paterno.

Sí: Introduzca el número de 4 dígitos.

No: Cancela la configuración de la contraseña.

Notas

- Si olvida la contraseña, podrá restablecer la contraseña actual empleando “Reinicio Sistema” en “Ajustes”. (página 34)
- Si lo desea también puede ajustar la nueva contraseña.

Acceso A BD Internet

Esto permite ajustar las restricciones de acceso a contenidos BD-LIVE.

Permitir: Permite todos los discos BD-LIVE.

Limite: Permite únicamente los discos con certificación de propietario.

Prohibir: Prohíbe todos los discos BD-LIVE.

Notas

- Las funciones disponibles difieren dependiendo del disco.
- En relación con el método de reproducción de contenidos BD-LIVE, etc., lleve a cabo las operaciones de acuerdo con las instrucciones del manual del disco BD.
- Para disfrutar de las funciones BD-LIVE, realice la conexión a Internet de banda ancha (página 14) y los ajustes de comunicación (páginas 34–36).

■ Versión

Cuando selecciona “Versión” se visualiza la versión del software del sistema.

■ Reinicio Sistema

Puede restablecer todos las configuraciones a los preajustados en fábrica.

Restablecer. No restablecer

■ Configuración De Comunicaciones

Esto le permite ejecutar y/o cambiar la configuración de las comunicaciones. Este ajuste es necesario para utilizar las funciones BD-LIVE que se conectan con Internet.

Notas

- Compruebe que el cable LAN está conectado con este reproductor. (Consulte la página 14.)
- Para ejecutar el ajuste manualmente, se necesita la siguiente información sobre el enrutador o módem conectado. Confirme la información antes del ajuste.
 - Dirección IR máscara de red, puerta enlace, dirección IP de DNS.
- Además, si se especifica un servidor proxy, también se necesita la siguiente información especificada por su proveedor de servicio de Internet. Confirme la información antes del ajuste.
 - Dirección IP y número de puerto del servidor proxy

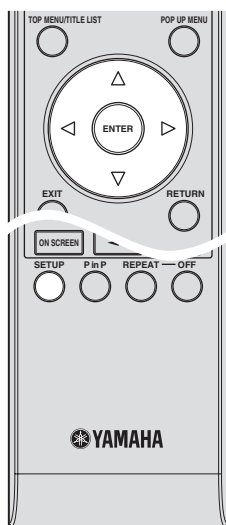

- ① Pulse **SETUP** para visualizar la pantalla del menú de configuración.
- ② Pulse $\Delta / \nabla / \triangleleft / \triangleright$ para seleccionar “Ajustes” y, a continuación, pulse **ENTER**.
- ③ Pulse Δ / ∇ para seleccionar “Configuración De Comunicaciones” y, a continuación, pulse **ENTER**.
- ④ Seleccione “Configuración Ethernet (BD-LIVE)” y, a continuación, pulse **ENTER**.

- ⑤ Pulse $\triangleleft / \triangleright$ para seleccionar “Cambiar” y, a continuación, pulse **ENTER**.

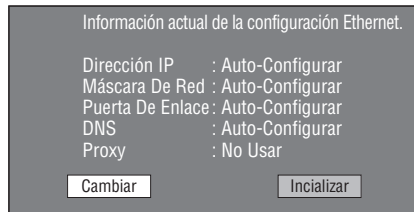

- Para inicializar la configuración actual, seleccione “Inicializar” y, después, pulse **ENTER**.

- ⑥ Para establecer la dirección IP, pulse $\triangleleft / \triangleright$ para seleccionar “Sí” o “No” y, después, pulse **ENTER**.

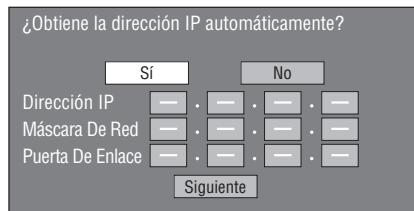

- Si selecciona “Sí”: La dirección IP se obtiene automáticamente.
- Si selecciona “No”: La dirección IP, máscara de red y puerta enlace se introducen manualmente utilizando la pantalla para introducción de caracteres. (Consulte la página 36.) En relación con cada uno de los valores de configuración, confirme las especificaciones de su enrutador de banda ancha.

- ⑦ Seleccione “Siguiente” y pulse **ENTER**.

- ⑧ Para configurar la dirección IP de DNS, introduzca las direcciones IP primaria y secundaria utilizando la pantalla para introducción de caracteres. (Consulte la página 36.) En relación con cada uno de los valores de configuración, confirme las especificaciones de su enrutador de banda ancha.

- ⑨ Seleccione “Siguiente” y pulse **ENTER**.

- ⑩ Para establecer la dirección del servidor proxy, pulse $\triangleleft / \triangleright$ para seleccionar “Sí” o “No” y, después, pulse **ENTER**.

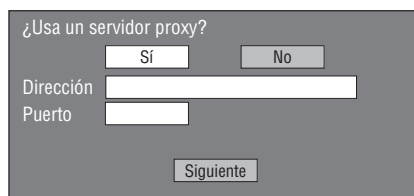

- Si selecciona “Sí”: La dirección IP o nombre del servidor proxy y número de puerto para el servidor proxy especificado por su proveedor de servicio de Internet se introducen utilizando la pantalla para introducción de caracteres. (Consulte la página 36.)
- Si selecciona “No”: Vaya al paso siguiente.

- ⑪ Seleccione “Siguiente” y pulse **ENTER**.

- ⑫ Para el ajuste avanzado (configuración de las velocidades de conexión Ethernet), pulse $\triangleleft / \triangleright$ para seleccionar “Sí” o “No” y, a continuación, pulse **ENTER**.

- Normalmente, seleccione “No” y pulse **ENTER**.

- Las velocidades de conexión Ethernet se pueden configurar seleccionado “Sí” y, después, pulsando **ENTER**.
- Como se realiza detección automática (modo preajustado en la fábrica), este ajuste usualmente no es necesario. Si ocurre una situación en la cual falla la conexión Ethernet, etc., cambie el ajuste y confirme si la conexión Ethernet funciona correctamente.
Cuando se haya establecido la velocidad de la conexión, seleccione “Siguiente” y pulse **ENTER**.

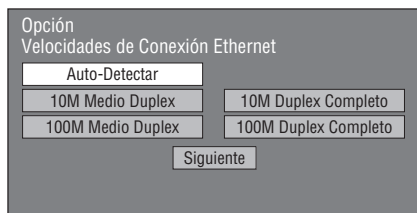

- ⑬ Para probar la conexión a Internet, después de confirmar la configuración, pulse $\triangleleft/\triangleright$ para seleccionar “Prueba” y, después, pulse **ENTER**.

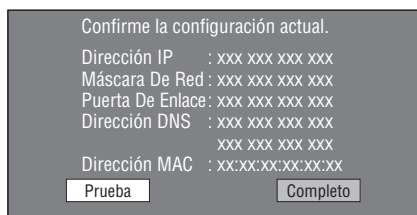

- Como resultado de la prueba, si falla la conexión, introduzca manualmente los valores de configuración.
- ⑭ Pulse $\triangleleft/\triangleright$ para seleccionar “Completo” y, a continuación, pulse **ENTER**.

Procedimiento para la introducción manual de los caracteres

Nota

- Caracteres numéricos tales como la dirección IP se pueden introducir en la pantalla de entrada seleccionando cada uno de los caracteres en el modo “Numérico” o utilizando las teclas **Numéricas** en el mando a distancia.

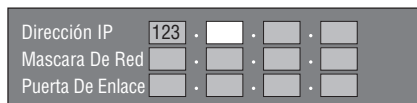

- ① Pulse **ENTER** en los cuadros en los que se han de introducir los caracteres y se visualizará la pantalla de entrada.

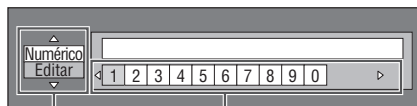

Seleccione pulsando \triangle/∇ Seleccione pulsando $\triangleleft/\triangleright$

- ② Pulse \triangle/∇ para seleccionar el modo de entrada que se desea.

- Cuando se introduzca la dirección del servidor proxy; “1ABC” (Carácter Alfabeto/Numérico) / “Carácter” / “Editar”
 - Cuando se introduzcan otros valores (dirección IP, etc.); “Numérico” / “Editar”
- ③ Pulse $\triangleleft/\triangleright$ para seleccionar un número/carácter y, después, pulse **ENTER**.
- ④ Repita el paso 3 para visualizar todos los caracteres/números deseados en el campo de entrada.

Ejemplo: La pantalla para introducir los caracteres numéricos

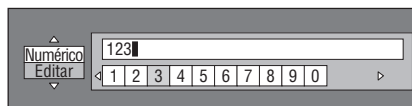

Nota

- Pulse **RETURN** (Borr. Carác.) para borrar un número/carácter que haya introducido.
Para cambiar un número/carácter que haya introducido, pulse **B** (Izqui.) o **C** (Dere.) para seleccionar el número/carácter que desea cambiar y, a continuación, después pulse **RETURN** (Borr. Carác.). Pulse entonces $\triangleleft/\triangleright$ para seleccionar el nuevo número/carácter que desea introducir y pulse **ENTER**.

- ⑤ Pulse **D** (Completo) para fijar los números que ha introducido.

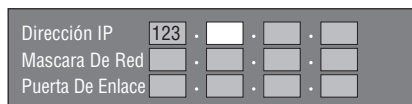

- ⑥ Repita los pasos 1 al 5 para terminar de introducir todos los caracteres requeridos.

Lista de caracteres de entrada

1ABC (Carácter Alfabeto/ Numérico)	Num.	ABC	DEF	GHI	JKL																		
	MON	PQRS	TUV	WXYZ	Esp.																		
	Num.	1 2 3 4 5 6 7 8 9 0																					
	ABC	A B C a b c																					
	DEF	D E F d e f																					
	GHI	G H I g h i																					
	JKL	J K L j k l																					
	MNO	M N O m n o																					
	PQRS	P Q R S p q r s																					
	TUV	T U V t u v																					
WXYZ	W X Y Z w x y z																						
Esp.	(espacio)																						
Numérico	1 2 3 4 5 6 7 8 9 0																						
Carácter	<table border="1"> <tr> <td>@ . , :</td> <td>; _ - \</td> <td>\$ % ! ?</td> <td>& # + *</td> <td>= / ~</td> </tr> <tr> <td>“ ‘ ^ ^</td> <td>() < ></td> <td>[] {}</td> <td>Esp.</td> <td></td> </tr> </table>					@ . , :	; _ - \	\$ % ! ?	& # + *	= / ~	“ ‘ ^ ^	() < >	[] {}	Esp.									
@ . , :	; _ - \	\$ % ! ?	& # + *	= / ~																			
“ ‘ ^ ^	() < >	[] {}	Esp.																				
	<table border="1"> <tr> <td>@ . , :</td> <td>@ . , :</td> </tr> <tr> <td>; _ - \</td> <td>; _ - \</td> </tr> <tr> <td>\$ % ! ?</td> <td>\$ % ! ?</td> </tr> <tr> <td>& # + *</td> <td>& # + *</td> </tr> <tr> <td>= / ~</td> <td>= / ~</td> </tr> <tr> <td>“ ‘ ^ ^</td> <td>“ ‘ ^ ^</td> </tr> <tr> <td>() < ></td> <td>() < ></td> </tr> <tr> <td>[] {}</td> <td>[] {}</td> </tr> <tr> <td>Esp.</td> <td>(espacio)</td> </tr> </table>					@ . , :	@ . , :	; _ - \	; _ - \	\$ % ! ?	\$ % ! ?	& # + *	& # + *	= / ~	= / ~	“ ‘ ^ ^	“ ‘ ^ ^	() < >	() < >	[] {}	[] {}	Esp.	(espacio)
@ . , :	@ . , :																						
; _ - \	; _ - \																						
\$ % ! ?	\$ % ! ?																						
& # + *	& # + *																						
= / ~	= / ~																						
“ ‘ ^ ^	“ ‘ ^ ^																						
() < >	() < >																						
[] {}	[] {}																						
Esp.	(espacio)																						
Editar	<table border="1"> <tr> <td>Cancelar</td> <td>Izqui.</td> <td>Dere.</td> </tr> <tr> <td>Completo</td> <td>Borr. Carác.</td> <td></td> </tr> </table> <p>* Seleccionando cada uno de los elementos y pulsando ENTER se puede realizar la misma operación que con las teclas de colores y RETURN. “Borr. Carác.” significa “borrar carácter”.</p>					Cancelar	Izqui.	Dere.	Completo	Borr. Carác.													
Cancelar	Izqui.	Dere.																					
Completo	Borr. Carác.																						

Antes de utilizar el dispositivo de memoria USB

PRECAUCIÓN:

- No desconecte el dispositivo de memoria USB ni desenchufe el cable de alimentación mientras se estén realizando las operaciones de “Manejo De Memoria USB” o “Actualiz. Software”.
- No utilice un cable alargador USB cuando conecte un dispositivo de memoria USB en el puerto USB BD STORAGE/SERVICE del reproductor. El uso de un cable alargador USB puede impedir que el reproductor funcione correctamente.

Nota

- Yamaha no puede garantizar que todas las marcas de dispositivos de memoria USB funcionen con este reproductor.

Manejo De Memoria USB

Las siguientes instrucciones explican cómo borrar datos de un dispositivo de memoria USB tales como los de Paquete Virtual y los de BD-LIVE.

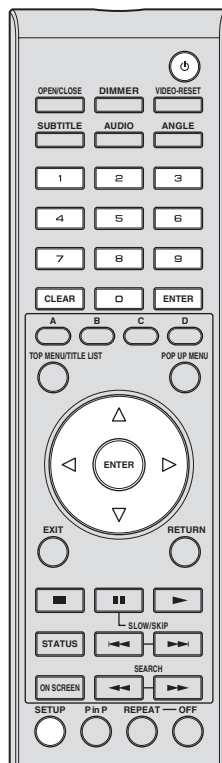

- 1 Inserte el dispositivo de memoria USB en el puerto USB BD STORAGE/SERVICE ubicado en la parte trasera de este reproductor.
- 2 Pulse **SETUP** para visualizar la pantalla del menú de configuración.
- 3 Pulse $\Delta / \nabla / \triangleleft / \triangleright$ para seleccionar “Ajustes” y, a continuación, pulse **ENTER**.
- 4 Pulse Δ / ∇ para seleccionar “Manejo De Memoria USB” y, a continuación, pulse **ENTER**.
 - Se visualizará “No hay memoria USB” cuando no se haya insertado una memoria USB.
- 5 Pulse Δ / ∇ para seleccionar “Borrar” o “Formatear” y, a continuación, pulse **ENTER**.

Borrar: Borra únicamente datos de vídeo BD registrados en el dispositivo de memoria USB, como datos BD-LIVE.

Formatear: Tenga en cuenta que se borrarán todos los datos, incluyendo los datos de vídeo BD y los de actualización del software.

Si únicamente desea borrar los datos de actualización del software que no necesita después de actualizar el software, borre en el PC los datos del dispositivo de memoria USB.

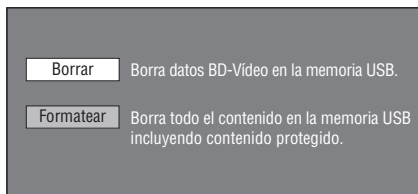
**Nota**

- También se borrarán los datos que se hayan guardado en la memoria interna del reproductor (puntuación de juegos, etc.)

- ⑥ Pulse ◀/▶ para seleccionar “SI” y, a continuación, pulse **ENTER**.



- ⑦ Comience el proceso.
- Se visualizará la pantalla para la operación en curso.



- ⑧ Pulse **ENTER**.

■ Actualiz. Software

Esta función le permite actualizar el software insertando el dispositivo de memoria USB que contiene el archivo de actualización en el puerto USB BD STORAGE/SERVICE de este reproductor. Consulte los detalles en la página 17.

Lista de códigos de países

EE. UU. / CANADÁ / JAPÓN / ALEMANIA / FRANCIA / REINO UNIDO / ITALIA / ESPAÑA / SUIZA / SUECIA / HOLANDA / NORUEGA / DINAMARCA / FINLANDIA / BÉLGICA / HONG KONG / SINGAPUR / TAILANDIA / MALASIA / INDONESIA / TAIWAN / FILIPINAS / AUSTRALIA / RUSIA / CHINA

Lista de idiomas

English / Frangals / Deutsch / Italiano / Español / Japanese / Svenska / Nederlands

Lista de códigos de idiomas

AA Afar / **AB** Abkhaziano / **AF** Afrikaans / **AM** Amárico / **AR** Árabe / **AS** Asamés / **AY** Aymará / **AZ** Azerí / **BA** Bashkir / **BE** Bielorruso / **BG** Búlgaro / **BH** Bihari / **BI** Bislama / **BN** Bengalí / **BO** Tibetano / **BR** Bretón / **CA** Catalán / **CO** Corso / **CS** Checo / **CY** Galés / **DA** Danés / **DE** Alemán / **DZ** Bhutaní / **EL** Griego / **EN** Inglés / **EO** Esperanto / **ES** Español / **ET** Estonio / **EU** Vasco / **FA** Farsi / **FI** Finlandés / **FJ** Fiji / **FO** Feroés / **FR** Francés / **FY** Frisio / **GA** Irlandés / **GD** Gaélico escocés / **GL** Gallego / **GN** Guaraní / **GU** Gujarati / **HA** Hausa / **HI** Hindi / **HR** Croata / **HU** Húngaro / **HY** Armenio / **IA** Interlingua / **IE** Interlingue / **IK** Inupiak / **IN** Indonesio / **IS** Islandés / **IT** Italiano / **IW** Hebreo / **JA** Japonés / **JI** Yidish / **JW** Javanés / **KA** Georgiano / **KK** Kazaj / **KL** Groenlandés / **KM** Camboyano / **KN** Kannada / **KO** Coreano / **KS** Cachemir / **KU** Kurdo / **KY** Kirguiz / **LA** Latín / **LN** Lingala / **LO** Laosiano / **LT** Lituano / **LV** Latvio, Letón / **MG** Malgache / **MI** Maorí / **MK** Macedonio / **ML** Malayalam / **MN** Mongol / **MO** Moldavo / **MR** Marathi / **MS** Malayo / **MT** Maltés / **MY** Birmano / **NA** Nauru / **NE** Nepalí / **NL** Holandés / **NO** Noruego / **OC** Occitano / **OM** Afan (Oromo) / **OR** Oriya / **PA** Panjabi / **PL** Polaco / **PS** Pashto / **PT** Portugués / **QU** Quechua / **RM** Pasto-Romance / **RN** Kirundi / **RO** Rumano / **RU** Ruso / **RW** Kinyarwanda / **SA** Sánscrito / **SD** Sindhi / **SG** Sangho / **SH** Serbo-Croata / **SI** Singalés / **SK** Eslovaco / **SL** Eslovenio / **SM** Samoano / **SN** Shona / **SO** Somalí / **SQ** Albano / **SR** Serbio / **SS** Siswat / **ST** Sesotho / **SU** Sundanés / **SV** Sueco / **SW** Suahili / **TA** Tamil / **TE** Telugu / **TG** Tajik / **TH** Tailandés / **TI** Tigrinya / **TK** Turcmeno / **TL** Tagalo / **TN** Setswana / **TO** Tonga / **TR** Turco / **TS** Tsonga / **TT** Tatar / **TW** Twi / **UK** Ucrainiano / **UR** Urdu / **UZ** Uzbeco / **VI** Vietnamita / **VO** Volapük / **WO** Wolof / **XH** Xhosa / **YO** Yoruba / **ZH** Chino / **ZU** Zulú

Formatos de salida de audio

Ajustes en este reproductor			Formato de salida de audio desde cada toma de audio			
Salida De Audio	Audio Secundario	Formato de salida (Salida De Audio)	Salida HDMI	Salida óptica/coaxial	Salida 8 canales discretos	Salida 2 canales mezclados
Salida De HDMI	Encender	Bitstream	No se puede seleccionar este modo			
		PCM	Máx. 7.1 canales PCM (48 kHz) *1	2 canales PCM (48 kHz)	2 canales	2 canales
	Apagar	Bitstream	Máx 7.1 canales Bitstream (Máx. 192 kHz)	2 canales PCM (48 kHz)	2 canales	2 canales
		PCM	Máx. 7.1 canales PCM (Máx. 192 kHz) *2	2 canales PCM (48 kHz)	2 canales	2 canales
Salida Digital	Encender	Bitstream	2 canales PCM (48 kHz)	Máx 5.1 canales Bitstream (48 kHz)	2 canales	2 canales
		PCM	2 canales PCM (48 kHz)	2 canales PCM (48 kHz)	2 canales	2 canales
	Apagar	Bitstream	2 canales PCM (48 kHz)	Máx. 5.1 canales Bitstream (48 kHz) *3	2 canales	2 canales
		PCM	2 canales PCM (48 kHz)	2 canales PCM (48 kHz) *3	2 canales	2 canales
Salida Audio 7.1ch	Encender	—	2 canales PCM (48 kHz)	2 canales PCM (48 kHz)	Máx. 7.1 canales *1	2 canales
	Apagar	—	2 canales PCM (48 kHz)	2 canales PCM (48 kHz)	Máx. 7.1 canales	2 canales
Salida Audio 2ch	Encender	—	2 canales PCM (48 kHz)	2 canales PCM (48 kHz)	2 canales	2 canales
	Apagar	—	2 canales PCM (48 kHz)	2 canales PCM (48 kHz)	2 canales	2 canales

*1 Máx. 5.1 canales PCM en el caso de reproducir fuentes de audio DTS (incluyendo DTS-HD).

*2 El DTS-HD Master Audio con 192 kHz multicanal sale en formato "96 kHz multicanal".

*3 La señal de 96 kHz sale cuando el contenido que se reproduce está grabado en 96 kHz y sin protección de copia.

*4 El audio MPEG sale en formato PCM de 2 canales.

Resolución de problemas

Consulte la tabla inferior cuando el equipo no funcione correctamente. Si el problema que usted tiene no aparece en la lista inferior o las instrucciones no le sirven de ayuda, apague esta unidad, desenchufe el cable de alimentación y póngase en contacto con un centro de servicio o concesionario Yamaha autorizado.

■ Alimentación

Problema	Causas posibles y soluciones
El reproductor no se puede encender.	<ul style="list-style-type: none"> – ¿Está el cable de alimentación firmemente enchufado en la toma de CA? (Página 15) – Cuando el cable esté enchufado en la toma de CA, pulse y mantenga pulsado  en el reproductor hasta que en el visor del panel delantero aparezca "RESET". A continuación, encienda el equipo. (Página 16)
La alimentación del reproductor está apagada.	<ul style="list-style-type: none"> – ¿Está el ajuste "Apagado Automático" en "Sí"? Cuando "Apagado Automático" está ajustado en "Sí", la alimentación se apaga automáticamente después de 10 minutos continuos de inactividad (sin reproducción). (Página 33)

■ Operación básica

Problema	Causas posibles y soluciones
El mando a distancia no funciona.	<ul style="list-style-type: none"> – Utilice el mando a distancia dentro de su alcance operativo. (Página 16) – Cambie las pilas. (Página 16) – Revise las configuraciones de la ID para la unidad principal y para el mando a distancia. (Página 7.)
No puede hacer funcionar el reproductor.	<ul style="list-style-type: none"> – ¿Está haciendo funcionar el reproductor dentro de la gama de temperaturas de funcionamiento? (Página 43)

■ Reproducción de disco

Problema	Causas posibles y soluciones
El reproductor no puede reproducir un disco.	<ul style="list-style-type: none"> – Extraiga el disco y límpielo. (Página 4) – Asegúrese de que se ha cargado correctamente el disco (alineado en la bandeja portadiscos y con la cara de la etiqueta hacia arriba). (Página 4) – Compruebe que el código de región del disco coincide con el de este reproductor. (Página 2) – Permita que desaparezca cualquier condensación en o cerca del reproductor. (Página 4) – Compruebe que el disco está grabado en un sistema de televisión compatible (PAL o NTSC). – El reproductor no puede reproducir vídeo que no se grabó normalmente. (Página 3) – La reproducción correcta podría resultar imposible debido al estado de la grabación del disco, a que el disco está rayado, alabeado o sucio, al estado de la lente lectora, o a temas de incompatibilidad entre este reproductor y el disco que se está utilizando. (Páginas 3, 4) – Cuando el tiempo grabado de un disco es inusualmente corta, la reproducción podría ser imposible. – Los discos BD-RE/R grabados en un formato que no sea BDMV no se pueden reproducir. (Página 2)
El disco es expulsado automáticamente después de cerrar la bandeja portadiscos.	<ul style="list-style-type: none"> – Asegúrese de que se ha cargado correctamente el disco (alineado en la bandeja portadiscos y con la cara de la etiqueta hacia arriba). (Página 20) – Extraiga el disco y límpielo. (Página 4) – Compruebe que el código de región del disco coincide con el de este reproductor. (Página 2) – Asegúrese de que el disco es reproducible. (Página 2)
El vídeo se para.	<ul style="list-style-type: none"> – ¿Ha recibido el reproductor algún golpe o impacto? ¿Lo está utilizando en una ubicación inestable? El reproductor se parará si detecta golpes o vibraciones.
El reproductor hace un sonido de chasquido cuando comienza la reproducción o al cargar un disco.	<ul style="list-style-type: none"> – A veces, si no se ha utilizado durante algún tiempo, el reproductor puede hacer un sonido de chasquido al comenzar la reproducción. Estos sonidos no son averías sino condiciones normales de funcionamiento del reproductor.

■ Imagen

Problema	Causas posibles y soluciones
No hay imagen.	<ul style="list-style-type: none"> – Asegúrese de que los cables están correctamente conectados. (Página 8) – Asegúrese de que el televisor o receptor de A/V conectado está ajustado a la entrada correcta. (Página 8) – Extraiga el disco y límpielo. (Página 4) – Compruebe que el código de región del disco coincide con el de este reproductor. (Página 2) – No hay imagen desde la salida HDMI. <ul style="list-style-type: none"> – ¿Se han ejecutado correctamente los ajustes? Revise por favor los ajustes. (Página 30) – No hay imagen desde la salida de vídeo componente. <ul style="list-style-type: none"> – ¿Se han ejecutado correctamente los ajustes? Revise por favor los ajustes. (Página 30)

La pantalla se congela y las teclas de operación no responden.	<ul style="list-style-type: none"> – Pulse ■ y, después, reinicie la reproducción. – Desconecte la alimentación y conéctela de nuevo. – Si la alimentación no está apagada, ejecute un reinicio. (Página 41) – ¿Está dañado o sucio el disco? Compruebe el estado del disco. (Página 4)
Solamente hay audio sin vídeo.	<ul style="list-style-type: none"> – ¿Está el cable de conexión para la salida de vídeo correctamente conectado? (Páginas 9–11)
El vídeo no sale con la resolución deseada.	<ul style="list-style-type: none"> – ¿Está “Selección Salida De Vídeo” correctamente configurada? (Página 31) – ¿Están “Salida De Vídeo Componente” o “Salida De Vídeo HDMI” configuradas en la resolución deseada? (Páginas 30-31)
El vídeo de ancho horizontal aparece estirado verticalmente, o aparecen bandas negras en las partes superior e inferior de la pantalla.	<ul style="list-style-type: none"> – ¿Está “Relación Aspecto TV” configurado para coincidir con el televisor conectado? (Página 30) – Si está utilizando un televisor de pantalla ancha, ¿está “Relación Aspecto TV” establecido en “Panor.”? (Página 30)
El vídeo 4:3 aparece alargado horizontalmente	<ul style="list-style-type: none"> – Si está utilizando un televisor 4:3, ¿está “Selección Salida De Vídeo” ajustado en “Componente”? (Página 31)
Aparece ruido cuadrado (mosaicos) en la pantalla.	<ul style="list-style-type: none"> – Se podrían ver bloques en las imágenes en escenas que contengan movimientos rápidos debido a las características de la tecnología de compresión de imagen digital.
La pantalla de reproducción se perturbará si se graba vídeo DVD en una videogradora, o se reproduce a través de una videogradora.	<ul style="list-style-type: none"> – Este reproductor cumple con la protección contra copias analógicas. Algunos discos contienen una señal de prohibición de copia. Si intenta reproducir tales discos a través de una videogradora, o grabar a una videogradora y reproducir la señal, la protección contra copia impedirá la reproducción normal. (Páginas 10–11)
No hay salida de audio o las imágenes no se reproducen adecuadamente.	<ul style="list-style-type: none"> – En algunos discos en los que se ha grabado contenido protegido por derechos de autor es posible que no haya salida de audio o que las imágenes no se reproduzcan adecuadamente.

■ Sonido

Problema	Causas posibles y soluciones
No hay sonido o está distorsionado.	<ul style="list-style-type: none"> – Si el volumen del televisor o del amplificador está ajustado al mínimo, suba el volumen. – No hay sonido durante el modo de reproducción fija, cámara lenta, avance rápido y retroceso rápido. (Página 20) – Compruebe que el cable de audio está correctamente conectado. (Página 12) – Compruebe que las clavijas de los cables están limpias. – Extraiga el disco y límpielo. (Página 4) – El audio puede no salir dependiendo del estado de grabación del audio, por ejemplo, cuando se haya grabado como contenido de audio del disco, audio que no sea una señal de audio o audio no estándar. (Página 3)
Los canales de audio izquierdo y derecho están invertidos o el sonido sólo sale por uno de ellos.	<ul style="list-style-type: none"> – ¿Están conectados los cables de audio izquierdo y derecho en el terminal opuesto, o está desconectado uno de los lados? (Página 13)
No hay salida de audio o las imágenes no se reproducen adecuadamente.	<ul style="list-style-type: none"> – En algunos discos en los que se ha grabado contenido protegido por derechos de autor es posible que no haya salida de audio o que las imágenes no se reproduzcan adecuadamente.
No se puede escuchar el tipo de audio que se desea y/o el número de canales.	<ul style="list-style-type: none"> – Consulte la configuración “Salida De Audio” (Página 31) y “Acerca de los formatos de salida de audio”. (Página 38)

■ Red

Problema	Causas posibles y soluciones
No se puede conectar a Internet.	<ul style="list-style-type: none"> – ¿Está el cable de red conectado correctamente? – ¿Se está utilizando un cable incorrecto, por ejemplo, un cable modular? Conecte un cable de red al puerto NETWORK. (Página 14) – ¿Está encendida la alimentación del equipo conectado, por ejemplo, el módem o enrutador de banda ancha? – ¿Está conectado correctamente el módem y/o el enrutador de banda ancha? – ¿Están bien configurados el valor o valores de la red? Revise “Configuración De Comunicaciones”. (Páginas 34–36)
No se pueden descargar contenidos BD-LIVE.	<ul style="list-style-type: none"> – ¿Está correctamente conectado el cable LAN? – ¿Está correctamente conectado el dispositivo de memoria USB? Compruebe que el dispositivo de memoria USB está conectado en el puerto USB BD STORAGE/SERVICE de este reproductor. – Compruebe que el disco BD es compatible con BD-LIVE. – Revise la configuración para “Acceso A BD Internet”. (Página 33)

■ Otro

Problema	Causas posibles y soluciones
El televisor no funciona correctamente.	– Algunos televisores con capacidad para mandos a distancia inalámbricos podrían funcionar incorrectamente cuando se utilice el mando a distancia de este reproductor. Utilice tales televisores alejados de este reproductor.
El reproductor se calienta durante su utilización.	– Cuando utilice este reproductor, la caja de la consola podría calentarse, dependiendo del entorno de utilización. Esto no es una avería.

■ Mensajes relacionados con discos BD y DVD

- Los mensajes siguientes aparecerán en la pantalla del televisor si el disco que intenta reproducir no es apropiado o la operación no es correcta.

Mensaje de error	Error posible	Error posible
Imposible reproducir.	– El disco no se puede reproducir con este reproductor.	– Revise el disco y cárguelo correctamente.
Disco incompatible.	– Este mensaje aparecerá si se carga un disco que no se puede reproducir en este reproductor (p. ej., un disco rayado), o si se carga un disco al revés, y la bandeja portadiscos se abrirá automáticamente.	
	– Ocurrirá si el disco que se ha cargado no se puede reproducir porque no es estándar, está rayado, etc.	– Extraiga el disco.
Imposible operar.	– Ocurrirá si la operación es incorrecta.	
Esta memoria USB no está formateada correctamente. Formatee la memoria en gestión de la memoria USB.	– Ocurrirá si hay un error de formateo.	– Formatee nuevamente la memoria USB.
	– Ocurre si la memoria USB no está formateada con FAT 32/16.	– Formatee la memoria USB en su PC.
No se puede usar la memoria USB conectada. La misma debe ser compatible con USB 2.0.	– Ocurrirá si se utiliza una memoria USB que no es compatible con USB 2.0 de alta velocidad (480 MB/S) (p.ej. USB 1.0/USB 1.1).	– Conecte una memoria USB compatible con USB 2.0 de alta velocidad (480 MB/S).

Para reiniciar este reproductor



Si este reproductor recibe fuertes interferencias procedentes de una fuente, por ejemplo, excesiva electricidad estática, ruido externo intenso, avería en el suministro eléctrico, o tensión provocada por relámpagos durante la utilización, o si se envía una operación incorrecta al reproductor, podrían ocurrir errores como que el reproductor no acepte una operación.

- ① Cuando el reproductor no funcione correctamente incluso después de que se haya apagado la alimentación, pulse y mantenga pulsado  en el reproductor hasta que en el visor del panel delantero aparezca “RESET”.
- ② Encienda el aparato.

Notas

- Cuando se ejecuta un reinicio estando la alimentación encendida, el reproductor se apagará. Encienda de nuevo la alimentación. En este punto, podría pasar cierto tiempo hasta que el procesamiento del sistema finalice y el reproductor esté listo para su uso.
- Cuando el problema persista incluso después de llevar a cabo un reinicio, desenchufe el cable de alimentación y enchúfelo de nuevo. Si esto no resuelve el problema, póngase en contacto con el centro de servicio aprobado por Yamaha más cercano.

Función de bloqueo de teclas

Puede ajustar el bloqueo de teclas para impedir operaciones fortuitas. Pulse y mantenga pulsado  y  en el panel delantero durante más de 4 segundos cuando en este reproductor no se haya introducido un disco y la bandeja portadiscos esté cerrada.

- Cada vez que realice esta operación, la función se activará o desactivará.
- Si intenta utilizar el reproductor cuando esté establecida la función de bloqueo, “Lock” parpadeará en el panel delantero para indicar que la función de bloqueo está activada.

Glosario

AVCHD

AVCHD es un nuevo formato (estándar) para cámaras de vídeo de alta definición que se puede utilizar para grabar y reproducir imágenes de alta definición (HD).

Aplicación BD-J

El formato BD-ROM soporta Java para funciones interactivas. “BD-J” ofrece a los proveedores de contenido una funcionalidad casi ilimitada durante la creación de títulos BD-ROM interactivos.

BDMV (Página 2)

BDMV (Blu-ray Disc Movie, BD-MV = Películas en disco Blu-ray BD-MV) se refiere a uno de los formatos de aplicación utilizados para BD-ROM que constituye una de las especificaciones de los discos Blu-ray.

BDMV es un formato de grabación equivalente al vídeo DVD de la especificación DVD.

Dolby Digital

Un sistema de sonido desarrollado por Dolby Laboratories Inc. que da un ambiente de sala de cine a la salida de audio cuando el producto está conectado con un amplificador o procesador Dolby Digital.

Dolby Digital Plus

Un sistema de sonido desarrollado como una extensión de Dolby Digital. Esta tecnología de codificación de audio soporta sonido envolvente de 7.1 multicanales.

Dolby TrueHD

Dolby TrueHD es una tecnología de codificación sin pérdidas que soporta hasta 8 canales de sonido envolvente multicanal para los discos ópticos de próxima generación. El sonido reproducido conserva fielmente, bit a bit, la fuente original.

DTS

Un sistema de sonido digital desarrollado por DTS, Inc. para su uso en salas de cine.

DTS-HD High Resolution Audio

DTS-HD High Resolution Audio es una nueva tecnología desarrollada para el formato de disco óptico de alta definición de próxima generación.

DTS-HD Master Audio

DTS-HD Master Audio es una tecnología de compresión de audio sin pérdidas desarrollada para el formato de disco óptico de alta definición de próxima generación.

DTS-HD Master Audio | Essential

DTS-HD Master Audio | Essential es una tecnología de compresión de audio sin pérdidas desarrollada para el formato de disco óptico de alta definición de próxima generación.

Escalado del DVD (página 20)

El escalado (conversión ascendente) se refiere a una función en varios reproductores y equipos que amplía el tamaño de la imagen para ajustarla al tamaño de la pantalla de equipos para vídeo, por ejemplo, televisores.

HDMI (página 9)

HDMI (High-Definition Multimedia Interface = Definición Multimedia de Alta Definición) es una interfaz que soporta vídeo y audio en una sola conexión digital. La conexión HDMI lleva señales de vídeo, lo mismo estándar que de alta definición, y señales de audio en multicanal a componentes A/V, por ejemplo, televisores equipados con HDMI, en forma digital y sin degradación.

Formato entrelazado

El formato entrelazado muestra las líneas alternas de una imagen como un único “campo” y es el método estándar para mostrar imágenes en televisión. El campo con número par muestra las líneas con números pares de una imagen, y el campo con número impar muestra las líneas con números impares de una imagen.

Buzón (LB 4:3) (página 30)

Un tamaño de pantalla con barras negras en las partes superior e inferior de la imagen para permitir la visualización de material en pantalla ancha (16:9) en un televisor 4:3 conectado.

Sonido PCM lineal

El PCM Lineal es un formato de grabación de señales utilizado para Audio CD y en algunos discos DVD y Blu-ray. El sonido de Audio CD se graba a 44,1 kHz con 16 bits. (En discos de vídeo DVD el sonido se graba a entre 48 kHz con 16 bits y 96 kHz con 24 bits, y en discos de vídeo BD a entre 48 kHz con 16 bits y 192 kHz con 24 bits.)

MPEG-2

MPEG-2 (Moving Picture Experts Group phase 2 = Grupo de Expertos en Imágenes en Movimiento fase 2) es uno de los esquemas de compresión de datos de vídeo adoptado para vídeos DVD y emisiones digitales en todo el mundo. Algunos discos Blu-ray también utilizan MPEG-2 con velocidad binaria alta.

Expl. Panor.: (PS 4:3) (página 30)

Un tamaño de pantalla que recorta los costados de la imagen para permitir la visualización de material de pantalla ancha (16:9) en un televisor 4:3 conectado.

Formato progresivo

En comparación con el formato entrelazado que muestra alternativamente las líneas alternas de una imagen (campo) para crear un fotograma, el formato progresivo muestra todo la imagen al mismo tiempo como un único fotograma. Esto significa que, mientras el formato entrelazado puede mostrar 30 fotogramas/60 campos en un segundo, el formato progresivo puede mostrar 60 fotogramas en un segundo. La calidad general de la imagen se incrementa y las imágenes fijas, texto y líneas horizontales aparecen más nítidas.

Subtítulos (página 26)

Son las líneas de texto que aparecen en la parte inferior de la pantalla y que traducen o transcriben el diálogo. Están grabadas en muchos discos de vídeo DVD y BD.

Menú principal (página 22)

En un vídeo BD/DVD, es el menú para seleccionar elementos tales como el capítulo que se va a reproducir y el idioma de los subtítulos. En algunos vídeos DVD, al menú principal también se le denomina “Menú de títulos”.

x.v.Color

x.v.Color reproduce una gama de colores más amplia que antes, mostrando casi todos los colores que puede detectar el ojo humano. (Aplicable para archivos JPEG solamente con este sistema)

Especificaciones

■ Generalidades

Alimentación

[Modelo de EE. UU.]	120 V CA, 60 Hz
[Modelo para América del Sur]	110–120 V CA, 50/60 Hz
[Modelo para Australia]	240 V CA, 50 Hz
[Modelos para Europa y Rusia]	230 V CA, 50 Hz
[Modelo para Asia]	220–240 V CA, 50/60 Hz
Consumo (normal).....	25 W
Consumo (en espera).....	1 W
Dimensiones (An x Al x Prof).....	435 x 96 x 315,5 mm
Peso	4,6 kg

■ Rendimiento de audio

Nivel de salida de audio (1 kHz, 0 dB, BD/DVD/CD-DA)	2 ± 0,3 V
Relación señal/ruido (BD/DVD/CD-DA)	115 dB o más
Gama dinámica	
BD/DVD	105 dB o más
CD-DA	100 dB o más
Distorsión armónica (1 kHz)	
BD/DVD	0,0028 % o menos
CD-DA	0,003 % o menos
Respuesta de frecuencia	
BD/DVD	de 2 Hz a 22 kHz (muestreo de 48 kHz)
	de 2 Hz a 44 kHz (muestreo de 96 kHz)
CD-DA	de 2 Hz a 20 kHz

■ Entrada/salida

Salida HDMI

[Modelos para EE. UU. y América del Sur]	Conector tipo A x 1
	480p/720p/1080i/1080p/1080p a 24 Hz,
	Soporte para Deep Color y "x.v. Color"
[Modelos para Australia, Europa y Rusia].....	Conector tipo A x 1
	480p/576p/720p/1080i/1080p/1080p a 24Hz,
	Soporte para Deep Color y "x.v. Color"

Salida de vídeo componente.....	Y: 1 Vp-p (75 ohmios)
	Pb, Pr: 0,7 Vp-p (75 ohmios)

Salida de S-vídeo

[Modelos para EE. UU. y América del Sur]	Y: 1 Vp-p (75 ohmios)
	C: 0,286 Vp-p (75 ohmios) (NTSC)
[Modelos para Australia, Europa y Rusia].....	Y: 1 Vp-p (75 ohmios)
	C: 0,3 Vp-p (75 ohmios) (PAL)

Salida de vídeo	1 Vp-p (75 ohmios)
-----------------------	--------------------

Salida digital.....	Óptica x 1, Coaxial x 1
---------------------	-------------------------

Salida de audio analógico.....	7.1 canales x 1, 2 canales mezclados x 1
--------------------------------	--

USB	Utilizado para:
	1) Reproducción de contenidos BD-LIVE/ BonusView
	2) Actualización del firmware

Otros equipos de salida	IN/OUT del mando a distancia x 1,
	RS-232C x 1 (para el instalador),
	Ethernet x 1 (para BD-LIVE)

Las especificaciones están sujetas a cambio sin previo aviso.

Información sobre la licencia de software para este producto

Composición del software

El software que se incluye en este producto se compone de diversos componentes de software sobre los cuales Yamaha o terceros tienen derechos de propiedad intelectual.

Software desarrollado por Yamaha y software de código abierto

Los derechos de propiedad intelectual de los componentes de software y diversos documentos relacionados que se incluyen con este producto y que fueron desarrollados o escritos por Yamaha son propiedad de Yamaha y están protegidos por la Ley de propiedad intelectual, tratados internacionales y otras leyes pertinentes. Este producto también emplea componentes de software y software distribuido gratuitamente cuyos derechos de propiedad intelectual pertenecen a terceros. Estos incluyen componentes de software cubiertos por una Licencia Pública General de GNU (en adelante, GPL), una Licencia Pública General Reducida de GNU (en adelante, LGPL) u otros acuerdos de licencia.

Nota sobre la distribución del código de fuente

Este producto incluye un código de software sujeto a la Licencia Pública General (GPL) GNU o a la Licencia Pública General Menor (LGPL) GNU. La copia, distribución o cambio de este código de software están sujetos a los términos de la GPL y la LGPL. El código de fuente está disponible en el sitio web siguiente:

<http://www.global.yamaha.com/download/>

El código de fuente también está disponible en un medio físico (tal como un CD-ROM) a su precio de coste.

Contacto: División de Productos AV, YAMAHA CORPORATION,
10-1 Nakazawa-cho, Naka-ku, Hamamatsu 430-8650, Japón

En principio, el código de fuente es válido para 3 años a partir del día de su compra.

Reconocimientos

En este producto se incluyen los siguientes componentes de software de código abierto:

• linux kernel • glibc • OpenSSL • modutils • DirectFB • zlib

Aviso sobre la licencia de software

Requisitos de aviso sobre la licencia de software

Los componentes de software incorporados en este producto incluyen componentes sobre los cuales los poseedores de los derechos de propiedad intelectual requieren avisos de licencia. A continuación se muestran los avisos de licencia para estos componentes de software.

Licencia OpenSSL

Este producto incluye software desarrollado por OpenSSL Project para su uso en el paquete de herramientas OpenSSL.
(<http://www.openssl.org>)

Licencia original SSLeay

Este producto incluye software criptográfico escrito por Eric Young (eay@cryptsoft.com).

Licencia BSD

Este producto incluye software desarrollado por la Universidad de California, Berkeley y sus colaboradores.

Information about software

Información sobre el software

This product uses the following software.
For information (copyright, etc) about each software, read the original sentences stated below.

■ About linux and busybox

GNU GENERAL PUBLIC LICENSE
Version 2, June 1991

Copyright (C) 1989, 1991 Free Software Foundation, Inc.
51 Franklin St, Fifth Floor, Boston, MA 02110-1301 USA

Everyone is permitted to copy and distribute verbatim copies of this license document, but changing it is not allowed.

Preamble

The licenses for most software are designed to take away your freedom to share and change it. By contrast, the GNU General Public License is intended to guarantee your freedom to share and change free software—to make sure the software is free for all its users. This General Public License applies to most of the Free Software Foundation's software and to any other program whose authors commit to using it. (Some other Free Software Foundation software is covered by the GNU Library General Public License instead.) You can apply it to your programs, too.

When we speak of free software, we are referring to freedom, not price. Our General Public Licenses are designed to make sure that you have the freedom to distribute copies of free software (and charge for this service if you wish), that you receive source code or can get it if you want it, that you can change the software or use pieces of it in new free programs; and that you know you can do these things.

To protect your rights, we need to make restrictions that forbid anyone to deny you these rights or to ask you to surrender the rights.

These restrictions translate to certain responsibilities for you if you distribute copies of the software, or if you modify it.

For example, if you distribute copies of such a program, whether gratis or for a fee, you must give the recipients all the rights that you have. You must make sure that they, too, receive or can get the source code. And you must show them these terms so they know their rights.

We protect your rights with two steps: (1) copyright the software, and (2) offer you this license which gives you legal permission to copy, distribute and/or modify the software. Also, for each author's protection and ours, we want to make certain that everyone understands that there is no warranty for this free software. If the software is modified by someone else and passed on, we want its recipients to know that what they have is not the original, so that any problems introduced by others will not reflect on the original authors' reputations.

Finally, any free program is threatened constantly by software patents. We wish to avoid the danger that redistributors of a free program will individually obtain patent licenses, in effect making the program proprietary. To prevent this, we have made it clear that any patent must be licensed for everyone's free use or not licensed at all. The precise terms and conditions for copying, distribution and modification follow.

GNU GENERAL PUBLIC LICENSE TERMS AND CONDITIONS FOR COPYING, DISTRIBUTION AND MODIFICATION

0. This License applies to any program or other work which contains a notice placed by the copyright holder saying it may be distributed under the terms of this General Public License. The "Program", below, refers to any such program or work, and a "work based on the Program" means either the Program or any derivative work under copyright law: that is to say, a work containing the Program or a portion of it, either verbatim or with modifications and/or translated into another language. (Hereinafter, translation is included without limitation in the term "modification".) Each licensee is addressed as "you".

Activities other than copying, distribution and modification are not covered by this License; they are outside its scope. The act of running the Program is not restricted, and the output from the Program is covered only if its contents constitute a work based on the Program (independent of having been made by running the Program). Whether that is true depends on what the Program does.

1. You may copy and distribute verbatim copies of the Program's source code as you receive it, in any medium, provided that you conspicuously and appropriately publish on each copy an appropriate copyright notice and disclaimer of warranty; keep intact all the notices that refer to this License and to the absence of any warranty; and give any other recipients of the Program a copy of this License along with the Program.

You may charge a fee for the physical act of transferring a copy, and you may at your option offer warranty protection in exchange for a fee.

2. You may modify your copy or copies of the Program or any portion of it, thus forming a work based on the Program, and copy and distribute such modifications or work under the terms of Section 1 above, provided that you also meet all of these conditions:

- You must cause the modified files to carry prominent notices stating that you changed the files and the date of any change.
- You must cause any work that you distribute or publish, that in whole or in part contains or is derived from the Program or any part thereof, to be licensed as a whole at no charge to all third parties under the terms of this License.
- If the modified program normally reads commands interactively when run, you must cause it, when started running for such interactive use in the most ordinary way, to print or display an announcement including an appropriate copyright notice and a notice that there is no warranty (or else, saying that you provide a warranty) and that users may redistribute the program under these

conditions, and telling the user how to view a copy of this License. (Exception: if the Program itself is interactive but does not normally print such an announcement, your work based on the Program is not required to print an announcement.)

These requirements apply to the modified work as a whole. If identifiable sections of that work are not derived from the Program, and can be reasonably considered independent and separate works in themselves, then this License, and its terms, do not apply to those sections when you distribute them as separate works. But when you distribute the same sections as part of a whole which is a work based on the Program, the distribution of the whole must be on the terms of this License, whose permissions for other licensees extend to the entire whole, and thus to each and every part regardless of who wrote it.

Thus, it is not the intent of this section to claim rights or contest your rights to work written entirely by you; rather, the intent is to exercise the right to control the distribution of derivative or collective works based on the Program.

In addition, mere aggregation of another work not based on the Program with the Program (or with a work based on the Program) on a volume of a storage or distribution medium does not bring the other work under the scope of this License.

3. You may copy and distribute the Program (or a work based on it, under Section 2) in object code or executable form under the terms of Sections 1 and 2 above provided that you also do one of the following:

- Accompany it with the complete corresponding machine-readable source code, which must be distributed under the terms of Sections 1 and 2 above on a medium customarily used for software interchange; or,
- Accompany it with a written offer, valid for at least three years, to give any third party, for a charge no more than your cost of physically performing source distribution, a complete machine-readable copy of the corresponding source code, to be distributed under the terms of Sections 1 and 2 above on a medium customarily used for software interchange; or,
- Accompany it with the information you received as to the offer to distribute corresponding source code. (This alternative is allowed only for noncommercial distribution and only if you received the program in object code or executable form with such an offer, in accord with Subsection b above.)

The source code for a work means the preferred form of the work for making modifications to it. For an executable work, complete source code means all the source code for all modules it contains, plus any associated interface definition files, plus the scripts used to control compilation and installation of the executable. However, as a special exception, the source code distributed need not include anything that is normally distributed (in either source or binary form) with the major components (compiler, kernel, and so on) of the operating system on which the executable runs, unless that component itself accompanies the executable.

If distribution of executable or object code is made by offering access to copy from a designated place, then offering equivalent access to copy the source code from the same place counts as distribution of the source code, even though third parties are not compelled to copy the source along with the object code.

4. You may not copy, modify, sublicense, or distribute the Program except as expressly provided under this License. Any attempt otherwise to copy, modify, sublicense or distribute the Program is void, and will automatically terminate your rights under this License. However, parties who have received copies, or rights, from you under this License will not have their licenses terminated so long as such parties remain in full compliance.

5. You are not required to accept this License, since you have not signed it. However, nothing else grants you permission to modify or distribute the Program or its derivative works. These actions are prohibited by law if you do not accept this License. Therefore, by modifying or distributing the Program (or any work based on the Program), you indicate your acceptance of this License to do so, and all its terms and conditions for copying, distributing or modifying the Program or works based on it.

6. Each time you redistribute the Program (or any work based on the Program), the recipient automatically receives a license from the original licensor to copy, distribute or modify the Program subject to these terms and conditions. You may not impose any further restrictions on the recipients' exercise of the rights granted herein. You are not responsible for enforcing compliance by third parties to this License.

7. If, as a consequence of a court judgment or allegation of patent infringement or for any other reason (not limited to patent issues), conditions are imposed on you (whether by court order, agreement or otherwise) that contradict the conditions of this License, they do not excuse you from the conditions of this License. If you cannot distribute so as to satisfy simultaneously your obligations under this License and any other pertinent obligations, then as a consequence you may not distribute the Program at all. For example, if a patent license would not permit royalty-free redistribution of the Program by all those who receive copies directly or indirectly through you, then the only way you could satisfy both it and this License would be to refrain entirely from distribution of the Program.

If any portion of this section is held invalid or unenforceable under any particular circumstance, the balance of the section is intended to apply and the section as a whole is intended to apply in other circumstances.

It is not the purpose of this section to induce you to infringe any patents or other property right claims or to contest validity of any such claims; this section has the sole purpose of protecting the integrity of the free software distribution system, which is implemented by public license practices. Many people have made generous contributions to the wide range of software distributed through that system in reliance on consistent application of that system; it is up to the author/donor to decide if he or she is willing to distribute software through any other system and a licensee cannot impose that choice.

This section is intended to make thoroughly clear what is believed to be a consequence of the rest of this License.

8. If the distribution and/or use of the Program is restricted in certain countries either by patents or by copyrighted interfaces, the original copyright holder who places the Program under this License may add an explicit geographical distribution limitation excluding those countries, so that distribution is permitted only in or among countries not thus excluded. In such case, this License incorporates the limitation as if written in the body of this License.

9. The Free Software Foundation may publish revised and/or new versions of the General Public License from time to time. Such new versions will be similar in spirit to the present version, but may differ in detail to address new problems or concerns.

Each version is given a distinguishing version number. If the Program specifies a version number of this License which applies to it and "any later version", you have the option of following the terms and conditions either of that version or of any later version published by the Free Software Foundation. If the Program does not specify a version number of this License, you may choose any version ever published by the Free Software Foundation.

10. If you wish to incorporate parts of the Program into other free programs whose distribution conditions are different, write to the author to ask for permission. For software which is copyrighted by the Free Software Foundation, write to the Free Software Foundation; we sometimes make exceptions for this. Our decision will be guided by the two goals of preserving the free status of all derivatives of our free software and of promoting the sharing and reuse of software generally.

NO WARRANTY

11. BECAUSE THE PROGRAM IS LICENSED FREE OF CHARGE, THERE IS NO WARRANTY FOR THE PROGRAM, TO THE EXTENT PERMITTED BY APPLICABLE LAW. EXCEPT WHEN OTHERWISE STATED IN WRITING THE COPYRIGHT HOLDERS AND/OR OTHER PARTIES PROVIDE THE PROGRAM "AS IS" WITHOUT WARRANTY OF ANY KIND, EITHER EXPRESSED OR IMPLIED, INCLUDING, BUT NOT LIMITED TO, THE IMPLIED WARRANTIES OF MERCHANTABILITY AND FITNESS FOR A PARTICULAR PURPOSE. THE ENTIRE RISK AS TO THE QUALITY AND PERFORMANCE OF THE PROGRAM IS WITH YOU. SHOULD THE PROGRAM PROVE DEFECTIVE, YOU ASSUME THE COST OF ALL NECESSARY SERVICING, REPAIR OR CORRECTION.

12. IN NO EVENT UNLESS REQUIRED BY APPLICABLE LAW OR AGREED TO IN WRITING WILL ANY COPYRIGHT HOLDER, OR ANY OTHER PARTY WHO MAY MODIFY AND/OR REDISTRIBUTE THE PROGRAM AS PERMITTED ABOVE, BE LIABLE TO YOU FOR DAMAGES, INCLUDING ANY GENERAL, SPECIAL, INCIDENTAL OR CONSEQUENTIAL DAMAGES ARISING OUT OF THE USE OR INABILITY TO USE THE PROGRAM (INCLUDING BUT NOT LIMITED TO LOSS OF DATA OR DATA BEING RENDERED INACCURATE OR LOSSES SUSTAINED BY YOU OR THIRD PARTIES OR A FAILURE OF THE PROGRAM TO OPERATE WITH ANY OTHER PROGRAMS), EVEN IF SUCH HOLDER OR OTHER PARTY HAS BEEN ADVISED OF THE POSSIBILITY OF SUCH DAMAGES.

END OF TERMS AND CONDITIONS

How to Apply These Terms to Your New Programs

If you develop a new program, and you want it to be of the greatest possible use to the public, the best way to achieve this is to make it free software which everyone can redistribute and change under these terms.

To do so, attach the following notices to the program. It is safest to attach them to the start of each source file to most effectively convey the exclusion of warranty; and each file should have at least the "copyright" line and a pointer to where the full notice is found.

```
<one line to give the program's name and a brief idea of what it does.>
Copyright (C) <year> <name of author>
```

This program is free software; you can redistribute it and/or modify it under the terms of the GNU General Public License as published by the Free Software Foundation; either version 2 of the License, or (at your option) any later version.

This program is distributed in the hope that it will be useful, but WITHOUT ANY WARRANTY; without even the implied warranty of MERCHANTABILITY or FITNESS FOR A PARTICULAR PURPOSE. See the GNU General Public License for more details.

You should have received a copy of the GNU General Public License along with this program; if not, write to the Free Software Foundation, Inc., 51 Franklin St, Fifth Floor, Boston, MA 02110-1301 USA

Also add information on how to contact you by electronic and paper mail.

If the program is interactive, make it output a short notice like this when it starts in an interactive mode:

```
Gnomovision version 69, Copyright (C) year name of author Gnomovision comes
with ABSOLUTELY NO WARRANTY; for details type 'show w'.
```

This is free software, and you are welcome to redistribute it under certain conditions; type 'show c' for details.

The hypothetical commands 'show w' and 'show c' should show the appropriate parts of the General Public License. Of course, the commands you use may be called something other than 'show w' and 'show c'; they could even be mouse-clicks or menu items--whatever suits your program.

You should also get your employer (if you work as a programmer) or your school, if any, to sign a "copyright disclaimer" for the program, if necessary. Here is a sample; alter the names:

```
Yoyodyne, Inc., hereby disclaims all copyright interest in the program
'Gnomovision' (which makes passes at compilers) written by James Hacker.
```

```
<signature of Ty Coon>, 1 April 1989
```

```
Ty Coon, President of Vice
```

This General Public License does not permit incorporating your program into proprietary programs. If your program is a subroutine library, you may consider it more useful to permit linking proprietary applications with the library. If this is what you want to do, use the GNU Library General Public License instead of this License.

■ About uClibc

GNU LIBRARY GENERAL PUBLIC LICENSE

Version 2, June 1991

Copyright (C) 1991 Free Software Foundation, Inc.
675 Mass Ave, Cambridge, MA 02139, USA

Everyone is permitted to copy and distribute verbatim copies of this license document, but changing it is not allowed.

[This is the first released version of the library GPL. It is numbered 2 because it goes with version 2 of the ordinary GPL.]

Preamble

The licenses for most software are designed to take away your freedom to share and change it. By contrast, the GNU General Public Licenses are intended to guarantee your freedom to share and change free software--to make sure the software is free for all its users.

This license, the Library General Public License, applies to some specially designated Free Software Foundation software, and to any other libraries whose authors decide to use it. You can use it for your libraries, too.

When we speak of free software, we are referring to freedom, not price. Our General Public Licenses are designed to make sure that you have the freedom to distribute copies of free software (and charge for this service if you wish), that you receive source code or can get it if you want it, that you can change the software or use pieces of it in new free programs; and that you know you can do these things.

To protect your rights, we need to make restrictions that forbid anyone to deny you these rights or to ask you to surrender the rights. These restrictions translate to certain responsibilities for you if you distribute copies of the library, or if you modify it.

For example, if you distribute copies of the library, whether gratis or for a fee, you must give the recipients all the rights that we gave you. You must make sure that they, too, receive or can get the source code. If you link a program with the library, you must provide complete object files to the recipients so that they can relink them with the library, after making changes to the library and recompiling it. And you must show them these terms so they know their rights.

Our method of protecting your rights has two steps: (1) copyright the library, and (2) offer you this license which gives you legal permission to copy, distribute and/or modify the library.

Also, for each distributor's protection, we want to make certain that everyone understands that there is no warranty for this free library. If the library is modified by someone else and passed on, we want its recipients to know that what they have is not the original version, so that any problems introduced by others will not reflect on the original authors' reputations.

Finally, any free program is threatened constantly by software patents. We wish to avoid the danger that companies distributing free software will individually obtain patent licenses, thus in effect transforming the program into proprietary software. To prevent this, we have made it clear that any patent must be licensed for everyone's free use or not licensed at all.

Most GNU software, including some libraries, is covered by the ordinary GNU General Public License, which was designed for utility programs. This license, the GNU Library General Public License, applies to certain designated libraries. This license is quite different from the ordinary one; be sure to read it in full, and don't assume that anything in it is the same as in the ordinary license.

The reason we have a separate public license for some libraries is that they blur the distinction we usually make between modifying or adding to a program and simply using it. Linking a program with a library, without changing the library, is in some sense simply using the library, and is analogous to running a utility program or application program. However, in a textual and legal sense, the linked executable is a combined work, a derivative of the original library, and the ordinary General Public License treats it as such.

Because of this blurred distinction, using the ordinary General Public License for libraries did not effectively promote software sharing, because most developers did not use the libraries. We concluded that weaker conditions might promote sharing better. However, unrestricted linking of non-free programs would deprive the users of those programs of all benefit from the free status of the libraries themselves. This Library General Public License is intended to permit developers of non-free programs to use free libraries, while preserving your freedom as a user of such programs to change the free libraries that are incorporated in them. (We have not seen how to achieve this as regards changes in header files, but we have achieved it as regards changes in the actual functions of the library.) The hope is that this will lead to faster development of free libraries.

The precise terms and conditions for copying, distribution and modification follow.

Pay close attention to the difference between a "work based on the library" and a "work that uses the library". The former contains code derived from the library, while the latter only works together with the library.

Note that it is possible for a library to be covered by the ordinary General Public License rather than by this special one.

GNU LIBRARY GENERAL PUBLIC LICENSE
TERMS AND CONDITIONS FOR COPYING, DISTRIBUTION AND
MODIFICATION

0. This License Agreement applies to any software library which contains a notice placed by the copyright holder or other authorized party saying it may be distributed under the terms of this Library General Public License (also called "this License"). Each licensee is addressed as "you".
A "library" means a collection of software functions and/or data prepared so as to be conveniently linked with application programs (which use some of those functions and data) to form executables.
The "Library", below, refers to any such software library or work which has been distributed under these terms. A "work based on the Library" means either the Library or any derivative work under copyright law: that is to say, a work containing the Library or a portion of it, either verbatim or with modifications and/or translated straightforwardly into another language. (Hereinafter, translation is included without limitation in the term "modification".)
"Source code" for a work means the preferred form of the work for making modifications to it. For a library, complete source code means all the source code for all modules it contains, plus any associated interface definition files, plus the scripts used to control compilation and installation of the library.
Activities other than copying, distribution and modification are not covered by this License; they are outside its scope. The act of running a program using the Library is not restricted, and output from such a program is covered only if its contents constitute a work based on the Library (independent of the use of the Library in a tool for writing it). Whether that is true depends on what the Library does and what the program that uses the Library does.
 1. You may copy and distribute verbatim copies of the Library's complete source code as you receive it, in any medium, provided that you conspicuously and appropriately publish on each copy an appropriate copyright notice and disclaimer of warranty; keep intact all the notices that refer to this License and to the absence of any warranty; and distribute a copy of this License along with the Library. You may charge a fee for the physical act of transferring a copy, and you may at your option offer warranty protection in exchange for a fee.
 2. You may modify your copy or copies of the Library or any portion of it, thus forming a work based on the Library, and copy and distribute such modifications or work under the terms of Section 1 above, provided that you also meet all of these conditions:
 - a) The modified work must itself be a software library.
 - b) You must cause the files modified to carry prominent notices stating that you changed the files and the date of any change.
 - c) You must cause the whole of the work to be licensed at no charge to all third parties under the terms of this License.
 - d) If a facility in the modified Library refers to a function or a table of data to be supplied by an application program that uses the facility, other than as an argument passed when the facility is invoked, then you must make a good faith effort to ensure that, in the event an application does not supply such function or table, the facility still operates, and performs whatever part of its purpose remains meaningful.
(For example, a function in a library to compute square roots has a purpose that is entirely well-defined independent of the application. Therefore, Subsection 2d requires that any application-supplied function or table used by this function must be optional: if the application does not supply it, the square root function must still compute square roots.)
- These requirements apply to the modified work as a whole. If identifiable sections of that work are not derived from the Library, and can be reasonably considered independent and separate works in themselves, then this License, and its terms, do not apply to those sections when you distribute them as separate works. But when you distribute the same sections as part of a whole which is a work based on the Library, the distribution of the whole must be on the terms of this License, whose permissions for other licensees extend to the entire whole, and thus to each and every part regardless of who wrote it.
- Thus, it is not the intent of this section to claim rights or contest your rights to work written entirely by you; rather, the intent is to exercise the right to control the distribution of derivative or collective works based on the Library.
- In addition, mere aggregation of another work not based on the Library with the Library (or with a work based on the Library) on a volume of a storage or distribution medium does not bring the other work under the scope of this License.- 3. You may opt to apply the terms of the ordinary GNU General Public License instead of this License to a given copy of the Library. To do this, you must alter all the notices that refer to this License, so that they refer to the ordinary GNU General Public License, version 2, instead of to this License. (If a newer version than version 2 of the ordinary GNU General Public License has appeared, then you can specify that version instead if you wish.) Do not make any other change in these notices.

Once this change is made in a given copy, it is irreversible for that copy, so the ordinary GNU General Public License applies to all subsequent copies and derivative works made from that copy.

This option is useful when you wish to copy part of the code of the Library into a program that is not a library.- 4. You may copy and distribute the Library (or a portion or derivative of it, under Section 2) in object code or executable form under the terms of Sections 1 and 2 above provided that you accompany it with the complete corresponding machine-readable source code, which must be distributed under the terms of Sections 1 and 2 above on a medium customarily used for software interchange.

If distribution of object code is made by offering access to copy from a designated place, then offering equivalent access to copy the source code from the same place satisfies the requirement to distribute the source code, even though third parties are not compelled to copy the source along with the object code.

5. A program that contains no derivative of any portion of the Library, but is designed to work with the Library by being compiled or linked with it, is called a "work that uses the Library". Such a work, in isolation, is not a derivative work of the Library, and therefore falls outside the scope of this License.

However, linking a "work that uses the Library" with the Library creates an executable that is a derivative of the Library (because it contains portions of the Library), rather than a "work that uses the Library". The executable is therefore covered by this License. Section 6 states terms for distribution of such executables.

When a "work that uses the Library" uses material from a header file that is part of the Library, the object code for the work may be a derivative work of the Library even though the source code is not. Whether this is true is especially significant if the work can be linked without the Library, or if the work is itself a library. The threshold for this to be true is not precisely defined by law.

If such an object file uses only numerical parameters, data structure layouts and accessors, and small macros and small inline functions (ten lines or less in length), then the use of the object file is unrestricted, regardless of whether it is legally a derivative work. (Executables containing this object code plus portions of the Library will still fall under Section 6.)

Otherwise, if the work is a derivative of the Library, you may distribute the object code for the work under the terms of Section 6. Any executables containing that work also fall under Section 6, whether or not they are linked directly with the Library itself.

6. As an exception to the Sections above, you may also compile or link a "work that uses the Library" with the Library to produce a work containing portions of the Library, and distribute that work under terms of your choice, provided that the terms permit modification of the work for the customer's own use and reverse engineering for debugging such modifications.

You must give prominent notice with each copy of the work that the Library is used in it and that the Library and its use are covered by this License. You must supply a copy of this License. If the work during execution displays copyright notices, you must include the copyright notice for the Library among them, as well as a reference directing the user to the copy of this License. Also, you must do one of these things:

- a) Accompany the work with the complete corresponding machine-readable source code for the Library including whatever changes were used in the work (which must be distributed under Sections 1 and 2 above); and, if the work is an executable linked with the Library, with the complete machine-readable "work that uses the Library", as object code and/or source code, so that the user can modify the Library and then relink to produce a modified executable containing the modified Library. (It is understood that the user who changes the contents of definitions files in the Library will not necessarily be able to recompile the application to use the modified definitions.)
- b) Accompany the work with a written offer, valid for at least three years, to give the same user the materials specified in Subsection 6a, above, for a charge no more than the cost of performing this distribution.
- c) If distribution of the work is made by offering access to copy from a designated place, offer equivalent access to copy the above specified materials from the same place.
- d) Verify that the user has already received a copy of these materials or that you have already sent this user a copy.

For an executable, the required form of the "work that uses the Library" must include any data and utility programs needed for reproducing the executable from it. However, as a special exception, the source code distributed need not include anything that is normally distributed (in either source or binary form) with the major components (compiler, kernel, and so on) of the operating system on which the executable runs, unless that component itself accompanies the executable.

It may happen that this requirement contradicts the license restrictions of other proprietary libraries that do not normally accompany the operating system. Such a contradiction means you cannot use both them and the Library together in an executable that you distribute.

7. You may place library facilities that are a work based on the Library side-by-side in a single library together with other library facilities not covered by this License, and distribute such a combined library, provided that the separate distribution of the work based on the Library and of the other library facilities is otherwise permitted, and provided that you do these two things:
 - a) Accompany the combined library with a copy of the same work based on the Library, uncombined with any other library facilities. This must be distributed under the terms of the Sections above.
 - b) Give prominent notice with the combined library of the fact that part of it is a work based on the Library, and explaining where to find the accompanying uncombined form of the same work.
8. You may not copy, modify, sublicense, link with, or distribute the Library except as expressly provided under this License. Any attempt otherwise to copy, modify, sublicense, link with, or distribute the Library is void, and will automatically terminate your rights under this License. However, parties who have received copies, or rights, from you under this License will not have their licenses terminated so long as such parties remain in full compliance.
9. You are not required to accept this License, since you have not signed it. However, nothing else grants you permission to modify or distribute the Library or its derivative works. These actions are prohibited by law if you do not accept this License. Therefore, by modifying or distributing the Library (or any work based on the Library), you indicate your acceptance of this License to do so, and all its terms and conditions for copying, distributing or modifying the Library or works based on it.

10. Each time you redistribute the Library (or any work based on the Library), the recipient automatically receives a license from the original licensor to copy, distribute, link with or modify the Library subject to these terms and conditions. You may not impose any further restrictions on the recipients' exercise of the rights granted herein. You are not responsible for enforcing compliance by third parties to this License.
11. If, as a consequence of a court judgment or allegation of patent infringement or for any other reason (not limited to patent issues), conditions are imposed on you (whether by court order, agreement or otherwise) that contradict the conditions of this License, they do not excuse you from the conditions of this License. If you cannot distribute so as to satisfy simultaneously your obligations under this License and any other pertinent obligations, then as a consequence you may not distribute the Library at all. For example, if a patent license would not permit royalty-free redistribution of the Library by all those who receive copies directly or indirectly through you, then the only way you could satisfy both it and this License would be to refrain entirely from distribution of the Library.

If any portion of this section is held invalid or unenforceable under any particular circumstance, the balance of the section is intended to apply, and the section as a whole is intended to apply in other circumstances.

It is not the purpose of this section to induce you to infringe any patents or other property right claims or to contest validity of any such claims; this section has the sole purpose of protecting the integrity of the free software distribution system which is implemented by public license practices. Many people have made generous contributions to the wide range of software distributed through that system in reliance on consistent application of that system; it is up to the author/donor to decide if he or she is willing to distribute software through any other system and a licensee cannot impose that choice.

This section is intended to make thoroughly clear what is believed to be a consequence of the rest of this License.

12. If the distribution and/or use of the Library is restricted in certain countries either by patents or by copyrighted interfaces, the original copyright holder who places the Library under this License may add an explicit geographical distribution limitation excluding those countries, so that distribution is permitted only in or among countries not thus excluded. In such case, this License incorporates the limitation as if written in the body of this License.
13. The Free Software Foundation may publish revised and/or new versions of the Library General Public License from time to time. Such new versions will be similar in spirit to the present version, but may differ in detail to address new problems or concerns.

Each version is given a distinguishing version number. If the Library specifies a version number of this License which applies to it and "any later version", you have the option of following the terms and conditions either of that version or of any later version published by the Free Software Foundation. If the Library does not specify a license version number, you may choose any version ever published by the Free Software Foundation.

14. If you wish to incorporate parts of the Library into other free programs whose distribution conditions are incompatible with these, write to the author to ask for permission. For software which is copyrighted by the Free Software Foundation, write to the Free Software Foundation; we sometimes make exceptions for this. Our decision will be guided by the two goals of preserving the free status of all derivatives of our free software and of promoting the sharing and reuse of software generally.

NO WARRANTY

15. BECAUSE THE LIBRARY IS LICENSED FREE OF CHARGE, THERE IS NO WARRANTY FOR THE LIBRARY. TO THE EXTENT PERMITTED BY APPLICABLE LAW, EXCEPT WHEN OTHERWISE STATED IN WRITING THE COPYRIGHT HOLDERS AND/OR OTHER PARTIES PROVIDE THE LIBRARY "AS IS" WITHOUT WARRANTY OF ANY KIND, EITHER EXPRESSED OR IMPLIED, INCLUDING, BUT NOT LIMITED TO, THE IMPLIED WARRANTIES OF MERCHANTABILITY AND FITNESS FOR A PARTICULAR PURPOSE. THE ENTIRE RISK AS TO THE QUALITY AND PERFORMANCE OF THE LIBRARY IS WITH YOU. SHOULD THE LIBRARY PROVE DEFECTIVE, YOU ASSUME THE COST OF ALL NECESSARY SERVICING, REPAIR OR CORRECTION.
16. IN NO EVENT UNLESS REQUIRED BY APPLICABLE LAW OR AGREED TO IN WRITING WILL ANY COPYRIGHT HOLDER, OR ANY OTHER PARTY WHO MAY MODIFY AND/OR REDISTRIBUTE THE LIBRARY AS PERMITTED ABOVE, BE LIABLE TO YOU FOR DAMAGES, INCLUDING ANY GENERAL, SPECIAL, INCIDENTAL OR CONSEQUENTIAL DAMAGES ARISING OUT OF THE USE OR INABILITY TO USE THE LIBRARY (INCLUDING BUT NOT LIMITED TO LOSS OF DATA OR DATA BEING RENDERED INACCURATE OR LOSSES SUSTAINED BY YOU OR THIRD PARTIES OR A FAILURE OF THE LIBRARY TO OPERATE WITH ANY OTHER SOFTWARE), EVEN IF SUCH HOLDER OR OTHER PARTY HAS BEEN ADVISED OF THE POSSIBILITY OF SUCH DAMAGES.

END OF TERMS AND CONDITIONS

Appendix: How to Apply These Terms to Your New Libraries

If you develop a new library, and you want it to be of the greatest possible use to the public, we recommend making it free software that everyone can redistribute and change. You can do so by permitting redistribution under these terms (or, alternatively, under the terms of the ordinary General Public License).

To apply these terms, attach the following notices to the library. It is safest to attach them to the start of each source file to most effectively convey the exclusion of warranty; and each file should have at least the "copyright" line and a pointer to where the full notice is found.

<one line to give the library's name and a brief idea of what it does.>

Copyright (C) <year> <name of author>

This library is free software; you can redistribute it and/or modify it under the terms of the GNU Library General Public License as published by the Free Software Foundation; either version 2 of the License, or (at your option) any later version.

This library is distributed in the hope that it will be useful, but WITHOUT ANY WARRANTY; without even the implied warranty of MERCHANTABILITY or FITNESS FOR A PARTICULAR PURPOSE. See the GNU Library General Public License for more details.

You should have received a copy of the GNU Library General Public License along with this library; if not, write to the Free Software Foundation, Inc., 675 Mass Ave, Cambridge, MA 02139, USA.

Also add information on how to contact you by electronic and paper mail.

You should also get your employer (if you work as a programmer) or your school, if any, to sign a "copyright disclaimer" for the library, if necessary. Here is a sample; alter the names:

Yoodyne, Inc., hereby disclaims all copyright interest in the library 'Frob' (a library for tweaking knobs) written by James Random Hacker.

<signature of Ty Coon>, 1 April 1990

Ty Coon, President of Vice

That's all there is to it!

■ About DirectFB

GNU LESSER GENERAL PUBLIC LICENSE

Version 2.1, February 1999

Copyright (C) 1991, 1999 Free Software Foundation, Inc.
59 Temple Place, Suite 330, Boston, MA 02111-1307 USA

Everyone is permitted to copy and distribute verbatim copies of this license document, but changing it is not allowed.

[This is the first released version of the Lesser GPL. It also counts as the successor of the GNU Library Public License, version 2, hence the version number 2.1.]

Preamble

The licenses for most software are designed to take away your freedom to share and change it. By contrast, the GNU General Public Licenses are intended to guarantee your freedom to share and change free software--to make sure the software is free for all its users.

This license, the Lesser General Public License, applies to some specially designated software packages--typically libraries--of the Free Software Foundation and other authors who decide to use it. You can use it too, but we suggest you first think carefully about whether this license or the ordinary General Public License is the better strategy to use in any particular case, based on the explanations below.

When we speak of free software, we are referring to freedom of use, not price. Our General Public Licenses are designed to make sure that you have the freedom to distribute copies of free software (and change for this service if you wish); that you receive source code or can get it if you want it; that you can change the software and use pieces of it in new free programs; and that you are informed that you can do these things.

To protect your rights, we need to make restrictions that forbid distributors to deny you these rights or to ask you to surrender these rights. These restrictions translate to certain responsibilities for you if you distribute copies of the library or if you modify it. For example, if you distribute copies of the library, whether gratis or for a fee, you must give the recipients all the rights that we gave you. You must make sure that they, too, receive or can get the source code. If you link other code with the library, you must provide complete object files to the recipients, so that they can relink them with the library after making changes to the library and recompiling it. And you must show them these terms so they know their rights.

We protect your rights with a two-step method: (1) we copyright the library, and (2) we offer you this license, which gives you legal permission to copy, distribute and/or modify the library.

To protect each distributor, we want to make it very clear that there is no warranty for the free library. Also, if the library is modified by someone else and passed on, the recipients should know that what they have is not the original version, so that the original author's reputation will not be affected by problems that might be introduced by others.

Finally, software patents pose a constant threat to the existence of any free program. We wish to make sure that a company cannot effectively restrict the users of a free program by obtaining a restrictive license from a patent holder. Therefore, we insist that any patent license obtained for a version of the library must be consistent with the full freedom of use specified in this license.

Most GNU software, including some libraries, is covered by the ordinary GNU General Public License. This license, the GNU Lesser General Public License, applies to certain designated libraries, and is quite different from the ordinary General Public License. We use this license for certain libraries in order to permit linking those libraries into non-free programs.

When a program is linked with a library, whether statically or using a shared library, the combination of the two is legally speaking a combined work, a derivative of the original library. The ordinary General Public License therefore permits such linking only if the entire combination fits its criteria of freedom. The Lesser General Public License permits more lax criteria for linking other code with the library.

We call this license the "Lesser" General Public License because it does Less to protect the user's freedom than the ordinary General Public License. It also provides other free software developers Less of an advantage over competing non-free programs. These disadvantages are the reason we use the ordinary General Public License for many libraries. However, the Lesser license provides advantages in certain special circumstances.

For example, on rare occasions, there may be a special need to encourage the widest possible use of a certain library, so that it becomes a de-facto standard. To achieve this, non-free programs must be allowed to use the library. A more frequent case is that a free library does the same job as widely used non-free libraries. In this case, there is little to gain by limiting the free library to free software only, so we use the Lesser General Public License.

In other cases, permission to use a particular library in non-free programs enables a greater number of people to use a large body of free software. For example, permission to use the GNU C Library in non-free programs enables many more people to use the whole GNU operating system, as well as its variant, the GNU/Linux operating system. Although the Lesser General Public License is less protective of the users' freedom, it does ensure that the user of a program that is linked with the Library has the freedom and the wherewithal to run that program using a modified version of the Library. The precise terms and conditions for copying, distribution and modification follow. Pay close attention to the difference between a "work based on the library" and a "work that uses the library". The former contains code derived from the library, whereas the latter must be combined with the library in order to run.

GNU LESSER GENERAL PUBLIC LICENSE TERMS AND CONDITIONS FOR COPYING, DISTRIBUTION AND MODIFICATION

0. This License Agreement applies to any software library or other program which contains a notice placed by the copyright holder or other authorized party saying it may be distributed under the terms of this GNU General Public License (also called "this License"). Each licensee is addressed as "you".

A "library" means a collection of software functions and/or data prepared so as to be conveniently linked with application programs (which use some of those functions and data) to form executables.

The "Library", below, refers to any such software library or work which has been distributed under these terms. A "work based on the Library" means either the Library or any derivative work under copyright law: that is to say, a work containing the Library or a portion of it, either verbatim or with modifications and/or translated straightforwardly into another language. (Hereinafter, translation is included without limitation in the term "modification".)

"Source code" for a work means the preferred form of the work for making modifications to it. For a library, complete source code means all the source code for all modules it contains, plus any associated interface definition files, plus the scripts used to control compilation and installation of the library.

Activities other than copying, distribution and modification are not covered by this License; they are outside its scope. The act of running a program using the Library is not restricted, and output from such a program is covered only if its contents constitute a work based on the Library (independent of the use of the Library in a tool for writing it). Whether that is true depends on what the Library does and what the program that uses the Library does.

1. You may copy and distribute verbatim copies of the Library's complete source code as you receive it, in any medium, provided that you conspicuously and appropriately publish on each copy an appropriate copyright notice and disclaimer of warranty; keep intact all the notices that refer to this License and to the absence of any warranty; and distribute a copy of this License along with the Library. You may charge a fee for the physical act of transferring a copy, and you may at your option offer warranty protection in exchange for a fee.

2. You may modify your copy or copies of the Library or any portion of it, thus forming a work based on the Library, and copy and distribute such modifications or work under the terms of Section 1 above, provided that you also meet all of these conditions:

- The modified work must itself be a software library.
- You must cause the files modified to carry prominent notices stating that you changed the files and the date of any change.
- You must cause the whole of the work to be licensed at no charge to all third parties under the terms of this License.
- If a facility in the modified Library refers to a function or a table of data to be supplied by an application program that uses the facility, other than as an argument passed when the facility is invoked, then you must make a good faith effort to ensure that, in the event an application does not supply such function or table, the facility still operates, and performs whatever part of its purpose remains meaningful.
(For example, a function in a library to compute square roots has a purpose that is entirely well-defined independent of the application. Therefore, Subsection 2d requires that any application-supplied function or table used by this function must be optional: if the application does not supply it, the square root function must still compute square roots.)

These requirements apply to the modified work as a whole. If identifiable sections of that work are not derived from the Library, and can be reasonably considered independent and separate works in themselves, then this License, and its terms, do not apply to those sections when you distribute them as separate works. But when you distribute the same sections as part of a whole which is a work based on the Library, the distribution of the whole must be on the terms of this License, whose permissions for other licensees extend to the entire whole, and thus to each and every part regardless of who wrote it.

Thus, it is not the intent of this section to claim rights or contest your rights to work written entirely by you; rather, the intent is to exercise the right to control the distribution of derivative or collective works based on the Library.

In addition, mere aggregation of another work not based on the Library with the Library (or with a work based on the Library) on a volume of a storage or distribution medium does not bring the other work under the scope of this License.

3. You may opt to apply the terms of the ordinary GNU General Public License instead of this License to a given copy of the Library. To do this, you must alter all the notices that refer to this License, so that they refer to the ordinary GNU General Public License, version 2, instead of to this License. (If a newer version than version 2 of the ordinary GNU General Public License has appeared, then you can specify that version instead if you wish.) Do not make any other change in these notices.

Once this change is made in a given copy, it is irreversible for that copy, so the ordinary GNU General Public License applies to all subsequent copies and derivative works made from that copy.

This option is useful when you wish to copy part of the code of the Library into a program that is not a library.

4. You may copy and distribute the Library (or a portion or derivative of it, under Section 2) in object code or executable form under the terms of Sections 1 and 2 above provided that you accompany it with the complete corresponding machine-readable source code, which must be distributed under the terms of Sections 1 and 2 above on a medium customarily used for software interchange.

If distribution of object code is made by offering access to copy from a designated place, then offering equivalent access to copy the source code from the same place satisfies the requirement to distribute the source code, even though third parties are not compelled to copy the source along with the object code.

5. A program that contains no derivative of any portion of the Library, but is designed to work with the Library by being compiled or linked with it, is called a "work that uses the Library". Such a work, in isolation, is not a derivative work of the Library, and therefore falls outside the scope of this License.

However, linking a "work that uses the Library" with the Library creates an executable that is a derivative of the Library (because it contains portions of the Library), rather than a "work that uses the library". The executable is therefore covered by this License. Section 6 states terms for distribution of such executables.

When a "work that uses the Library" uses material from a header file that is part of the Library, the object code for the work may be a derivative work of the Library even though the source code is not. Whether this is true is especially significant if the work can be linked without the Library, or if the work is itself a library. The threshold for this to be true is not precisely defined by law.

If such an object file uses only numerical parameters, data structure layouts and accessors, and small macros and small inline functions (ten lines or less in length), then the use of the object file is unrestricted, regardless of whether it is legally a derivative work. (Executables containing this object code plus portions of the Library will still fall under Section 6.)

Otherwise, if the work is a derivative of the Library, you may distribute the object code for the work under the terms of Section 6. Any executables containing that work also fall under Section 6, whether or not they are linked directly with the Library itself.

6. As an exception to the Sections above, you may also combine or link a "work that uses the Library" with the Library to produce a work containing portions of the Library, and distribute that work under terms of your choice, provided that the terms permit modification of the work for the customer's own use and reverse engineering for debugging such modifications.

You must give prominent notice with each copy of the work that the Library is used in it and that the Library and its use are covered by this License. You must supply a copy of this License. If the work during execution displays copyright notices, you must include the copyright notice for the Library among them, as well as a reference directing the user to the copy of this License. Also, you must do one of these things:

- Accompany the work with the complete corresponding machine-readable source code for the Library including whatever changes were used in the work (which must be distributed under Sections 1 and 2 above); and, if the work is an executable linked with the Library, with the complete machine-readable "work that uses the Library", as object code and/or source code, so that the user can modify the Library and then relink to produce a modified executable containing the modified Library. (It is understood that the user who changes the contents of definitions files in the Library will not necessarily be able to recompile the application to use the modified definitions.)
- Use a suitable shared library mechanism for linking with the Library. A suitable mechanism is one that (1) uses at run time a copy of the library already present on the user's computer system, rather than copying library functions into the executable, and (2) will operate properly with a modified version of the library, if the user installs one, as long as the modified version is interface-compatible with the version that the work was made with.
- Accompany the work with a written offer, valid for at least three years, to give the same user the materials specified in Subsection 6a, above, for a charge no more than the cost of performing this distribution.
- If distribution of the work is made by offering access to copy from a designated place, offer equivalent access to copy the above specified materials from the same place.
- Verify that the user has already received a copy of these materials or that you have already sent this user a copy.

For an executable, the required form of the "work that uses the Library" must include any data and utility programs needed for reproducing the executable from it. However, as a special exception, the materials to be distributed need not include anything that is normally distributed (in either source or binary form) with the major components (compiler, kernel, and so on) of the operating system on which the executable runs, unless that component itself accompanies the executable.

It may happen that this requirement contradicts the license restrictions of other proprietary libraries that do not normally accompany the operating system. Such a contradiction means you cannot use both them and the Library together in an executable that you distribute.

7. You may place library facilities that are a work based on the Library side-by-side in a single library together with other library facilities not covered by this License, and distribute such a combined library, provided that the separate distribution of the work based on the Library and of the other library facilities is otherwise permitted, and provided that you do these two things:

- a) Accompany the combined library with a copy of the same work based on the Library, uncombined with any other library facilities. This must be distributed under the terms of the Sections above.
- b) Give prominent notice with the combined library of the fact that part of it is a work based on the Library, and explaining where to find the accompanying uncombined form of the same work.

8. You may not copy, modify, sublicense, link with, or distribute the Library except as expressly provided under this License. Any attempt otherwise to copy, modify, sublicense, link with, or distribute the Library is void, and will automatically terminate your rights under this License. However, parties who have received copies, or rights, from you under this License will not have their licenses terminated so long as such parties remain in full compliance.

9. You are not required to accept this License, since you have not signed it. However, nothing else grants you permission to modify or distribute the Library or its derivative works. These actions are prohibited by law if you do not accept this License. Therefore, by modifying or distributing the Library (or any work based on the Library), you indicate your acceptance of this License to do so, and all its terms and conditions for copying, distributing or modifying the Library or works based on it.

10. Each time you redistribute the Library (or any work based on the Library), the recipient automatically receives a license from the original licensor to copy, distribute, link with or modify the Library subject to these terms and conditions. You may not impose any further restrictions on the recipients' exercise of the rights granted herein. You are not responsible for enforcing compliance by third parties with this License.

11. If, as a consequence of a court judgment or allegation of patent infringement or for any other reason (not limited to patent issues), conditions are imposed on you (whether by court order, agreement or otherwise) that contradict the conditions of this License, they do not excuse you from the conditions of this License. If you cannot distribute so as to satisfy simultaneously your obligations under this License and any other pertinent obligations, then as a consequence you may not distribute the Library at all. For example, if a patent license would not permit royalty-free redistribution of the Library by all those who receive copies directly or indirectly through you, then the only way you could satisfy both it and this License would be to refrain entirely from distribution of the Library.

If any portion of this section is held invalid or unenforceable under any particular circumstance, the balance of the section is intended to apply, and the section as a whole is intended to apply in other circumstances.

It is not the purpose of this section to induce you to infringe any patents or other property right claims or to contest validity of any such claims; this section has the sole purpose of protecting the integrity of the free software distribution system which is implemented by public license practices. Many people have made generous contributions to the wide range of software distributed through that system in reliance on consistent application of that system; it is up to the author/donor to decide if he or she is willing to distribute software through any other system and a licensee cannot impose that choice.

This section is intended to make thoroughly clear what is believed to be a consequence of the rest of this License.

12. If the distribution and/or use of the Library is restricted in certain countries either by patents or by copyrighted interfaces, the original copyright holder who places the Library under this License may add an explicit geographical distribution limitation excluding those countries, so that distribution is permitted only in or among countries not thus excluded. In such case, this License incorporates the limitation as if written in the body of this License.

13. The Free Software Foundation may publish revised and/or new versions of the Lesser General Public License from time to time. Such new versions will be similar in spirit to the present version, but may differ in detail to address new problems or concerns.

Each version is given a distinguishing version number. If the Library specifies a version number of this License which applies to it and "any later version", you have the option of following the terms and conditions either of that version or of any later version published by the Free Software Foundation. If the Library does not specify a license version number, you may choose any version ever published by the Free Software Foundation.

14. If you wish to incorporate parts of the Library into other free programs whose distribution conditions are incompatible with these, write to the author to ask for permission. For software which is copyrighted by the Free Software Foundation, write to the Free Software Foundation; we sometimes make exceptions for this. Our decision will be guided by the two goals of preserving the free status of all derivatives of our free software and of promoting the sharing and reuse of software generally.

NO WARRANTY

15. BECAUSE THE LIBRARY IS LICENSED FREE OF CHARGE, THERE IS NO WARRANTY FOR THE LIBRARY, TO THE EXTENT PERMITTED BY APPLICABLE LAW. EXCEPT WHEN OTHERWISE STATED IN WRITING THE COPYRIGHT HOLDERS AND/OR OTHER PARTIES PROVIDE THE

LIBRARY "AS IS" WITHOUT WARRANTY OF ANY KIND, EITHER EXPRESSED OR IMPLIED, INCLUDING, BUT NOT LIMITED TO, THE IMPLIED WARRANTIES OF MERCHANTABILITY AND FITNESS FOR A PARTICULAR PURPOSE. THE ENTIRE RISK AS TO THE QUALITY AND PERFORMANCE OF THE LIBRARY IS WITH YOU. SHOULD THE LIBRARY PROVE DEFECTIVE, YOU ASSUME THE COST OF ALL NECESSARY SERVICING, REPAIR OR CORRECTION.

16. IN NO EVENT UNLESS REQUIRED BY APPLICABLE LAW OR AGREED TO IN WRITING WILL ANY COPYRIGHT HOLDER, OR ANY OTHER PARTY WHO MAY MODIFY AND/OR REDISTRIBUTE THE LIBRARY AS PERMITTED ABOVE, BE LIABLE TO YOU FOR DAMAGES, INCLUDING ANY GENERAL, SPECIAL, INCIDENTAL OR CONSEQUENTIAL DAMAGES ARISING OUT OF THE USE OR INABILITY TO USE THE LIBRARY (INCLUDING BUT NOT LIMITED TO LOSS OF DATA OR DATA BEING RENDERED INACCURATE OR LOSSES SUSTAINED BY YOU OR THIRD PARTIES OR A FAILURE OF THE LIBRARY TO OPERATE WITH ANY OTHER SOFTWARE), EVEN IF SUCH HOLDER OR OTHER PARTY HAS BEEN ADVISED OF THE POSSIBILITY OF SUCH DAMAGES.

END OF TERMS AND CONDITIONS

How to Apply These Terms to Your New Libraries

If you develop a new library, and you want it to be of the greatest possible use to the public, we recommend making it free software that everyone can redistribute and change. You can do so by permitting redistribution under these terms (or, alternatively, under the terms of the ordinary General Public License).

To apply these terms, attach the following notices to the library. It is safest to attach them to the start of each source file to most effectively convey the exclusion of warranty; and each file should have at least the "copyright" line and a pointer to where the full notice is found.

<one line to give the library's name and a brief idea of what it does.>

Copyright (C) <year> <name of author>

This library is free software; you can redistribute it and/or modify it under the terms of the GNU Lesser General Public License as published by the Free Software Foundation; either version 2 of the License, or (at your option) any later version.

This library is distributed in the hope that it will be useful, but WITHOUT ANY WARRANTY; without even the implied warranty of MERCHANTABILITY or FITNESS FOR A PARTICULAR PURPOSE. See the GNU Lesser General Public License for more details.

You should have received a copy of the GNU Lesser General Public License along with this library; if not, write to the Free Software Foundation, Inc., 59 Temple Place, Suite 330, Boston, MA 02111-1307 USA

Also add information on how to contact you by electronic and paper mail.

You should also get your employer (if you work as a programmer) or your school, if any, to sign a "copyright disclaimer" for the library, if necessary. Here is a sample; alter the names:

Fooyodny, Inc., hereby disclaims all copyright interest in the library 'Frob' (a library for tweaking knobs) written by James Random Hacker.

<signature of Ty Coon>, 1 April 1990

Ty Coon, President of Vice

That's all there is to it!

■ About OpenSSL

OpenSSL License

Copyright (c) 1998-2007 The OpenSSL Project. All rights reserved.

Redistribution and use in source and binary forms, with or without modification, are permitted provided that the following conditions are met:

1. Redistributions of source code must retain the above copyright notice, this list of conditions and the following disclaimer.
2. Redistributions in binary form must reproduce the above copyright notice, this list of conditions and the following disclaimer in the documentation and/or other materials provided with the distribution.
3. All advertising materials mentioning features or use of this software must display the following acknowledgment:
"This product includes software developed by the OpenSSL Project for use in the OpenSSL Toolkit. (<http://www.openssl.org/>)"
4. The names "OpenSSL Toolkit" and "OpenSSL Project" must not be used to endorse or promote products derived from this software without prior written permission. For written permission, please contact openssl-core@openssl.org.
5. Products derived from this software may not be called "OpenSSL" nor may "OpenSSL" appear in their names without prior written permission of the OpenSSL Project.
6. Redistributions of any form whatsoever must retain the following acknowledgment:
"This product includes software developed by the OpenSSL Project for use in the OpenSSL Toolkit (<http://www.openssl.org/>)"

THIS SOFTWARE IS PROVIDED BY THE OPENSSL PROJECT "AS IS" AND ANY EXPRESSED OR IMPLIED WARRANTIES, INCLUDING, BUT NOT LIMITED TO, THE IMPLIED WARRANTIES OF MERCHANTABILITY AND FITNESS FOR A PARTICULAR PURPOSE ARE DISCLAIMED. IN NO EVENT

SHALL THE OpenSSL PROJECT OR ITS CONTRIBUTORS BE LIABLE FOR ANY DIRECT, INDIRECT, INCIDENTAL, SPECIAL, EXEMPLARY, OR CONSEQUENTIAL DAMAGES (INCLUDING, BUT NOT LIMITED TO, PROCUREMENT OF SUBSTITUTE GOODS OR SERVICES; LOSS OF USE, DATA, OR PROFITS; OR BUSINESS INTERRUPTION) HOWEVER CAUSED AND ON ANY THEORY OF LIABILITY, WHETHER IN CONTRACT, STRICT LIABILITY, OR TORT (INCLUDING NEGLIGENCE OR OTHERWISE) ARISING IN ANY WAY OUT OF THE USE OF THIS SOFTWARE, EVEN IF ADVISED OF THE POSSIBILITY OF SUCH DAMAGE.

This product includes cryptographic software written by Eric Young (eay@cryptsoft.com). This product includes software written by Tim Hudson (tjh@cryptsoft.com).

Original SSLey License

Copyright (C) 1995-1998 Eric Young (eay@cryptsoft.com) All rights reserved.

This package is an SSL implementation written by Eric Young (eay@cryptsoft.com). The implementation was written so as to conform with Netscapes SSL.

This library is free for commercial and non-commercial use as long as the following conditions are aheared to. The following conditions apply to all code found in this distribution, be it the RC4, RSA, lhash, DES, etc., code; not just the SSL code. The SSL documentation included with this distribution is covered by the same copyright terms except that the holder is Tim Hudson (tjh@cryptsoft.com).

Copyright remains Eric Young's, and as such any Copyright notices in the code are not to be removed.

If this package is used in a product, Eric Young should be given attribution as the author of the parts of the library used.

This can be in the form of a textual message at program startup or in documentation (online or textual) provided with the package.

Redistribution and use in source and binary forms, with or without modification, are permitted provided that the following conditions are met:

1. Redistributions of source code must retain the copyright notice, this list of conditions and the following disclaimer.
2. Redistributions in binary form must reproduce the above copyright notice, this list of conditions and the following disclaimer in the documentation and/or other materials provided with the distribution.
3. All advertising materials mentioning features or use of this software must display the following acknowledgement:
"This product includes cryptographic software written by Eric Young (eay@cryptsoft.com)"
The word 'cryptographic' can be left out if the rouines from the library being used are not cryptographic related :-).
4. If you include any Windows specific code (or a derivative thereof) from the apps directory (application code) you must include an acknowledgement:
"This product includes software written by Tim Hudson (tjh@cryptsoft.com)"

THIS SOFTWARE IS PROVIDED BY ERIC YOUNG "AS IS" AND ANY EXPRESS OR IMPLIED WARRANTIES, INCLUDING, BUT NOT LIMITED TO, THE IMPLIED WARRANTIES OF MERCHANTABILITY AND FITNESS FOR A PARTICULAR PURPOSE ARE DISCLAIMED. IN NO EVENT SHALL THE AUTHOR OR CONTRIBUTORS BE LIABLE FOR ANY DIRECT, INDIRECT, INCIDENTAL, SPECIAL, EXEMPLARY, OR CONSEQUENTIAL DAMAGES (INCLUDING, BUT NOT LIMITED TO, PROCUREMENT OF SUBSTITUTE GOODS OR SERVICES; LOSS OF USE, DATA, OR PROFITS; OR BUSINESS INTERRUPTION) HOWEVER CAUSED AND ON ANY THEORY OF LIABILITY, WHETHER IN CONTRACT, STRICT LIABILITY, OR TORT (INCLUDING NEGLIGENCE OR OTHERWISE) ARISING IN ANY WAY OUT OF THE USE OF THIS SOFTWARE, EVEN IF ADVISED OF THE POSSIBILITY OF SUCH DAMAGE.

The licence and distribution terms for any publically available version or derivative of this code cannot be changed. i.e. this code cannot simply be copied and put under another distribution licence [including the GNU Public Licence.]

■ About zlib

Copyright notice:

(C) 1995-2004 Jean-loup Gailly and Mark Adler

This software is provided 'as-is', without any express or implied warranty. In no event will the authors be held liable for any damages arising from the use of this software.

Permission is granted to anyone to use this software for any purpose, including commercial applications, and to alter it and redistribute it freely, subject to the following restrictions:

1. The origin of this software must not be misrepresented; you must not claim that you wrote the original software. If you use this software in a product, an acknowledgment in the product documentation would be appreciated but is not required.
2. Altered source versions must be plainly marked as such, and must not be misrepresented as being the original software.
3. This notice may not be removed or altered from any source distribution.

Jean-loup Gailly Mark Adler
jloup@zip.org madler@alumni.caltech.edu

If you use the zlib library in a product, we would appreciate *not* receiving lengthy legal documents to sign. The sources are provided for free but without warranty of any kind. The library has been entirely written by Jean-loup Gailly and Mark Adler; it does not include third-party code.

If you redistribute modified sources, we would appreciate that you include in the file ChangeLog history information documenting your changes. Please read the FAQ for more information on the distribution of modified source versions.

LASER Specification:

Class 1 LASER Product

Wave length: 788 nm (CDs)/654 nm (DVDs)/405 nm (BDs)

Laser power: No hazardous radiation is emitted with the safety protection

LASER SAFETY

This unit employs a laser. Due to possible eye injury, only a qualified service person should remove the cover or attempt to service this device.

DANGER

This unit emits visible laser radiation when open. Avoid direct eye exposure to beam. When this unit is plugged into the wall outlet, do not place your eyes close to the opening of the disc tray and other openings to look into inside.

Especificaciones LÁSER:

Producto LÁSER de Clase 1

Longitud de onda: 788 nm (CD)/654 nm (DVD)/405 nm (BD)

Potencia del láser: Con la protección de seguridad no se emiten radiaciones perjudiciales

SEGURIDAD DEL LÁSER

Esta unidad emplea un láser. Debido a las posibles lesiones oculares, únicamente una persona de mantenimiento cualificada debería retirar la tapa o intentar reparar este dispositivo.

PELIGRO

Esta unidad emite radiaciones de láser visible cuando está abierta. Evite la exposición directa de los ojos al rayo. Cuando esta unidad esté enchufada en la toma de corriente, no coloque sus ojos cerca de la apertura de la bandeja portadiscos y de otras aberturas para mirar en su interior.

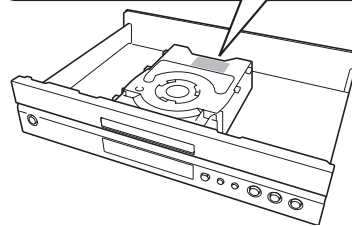

DANGER—VISIBLE AND INVISIBLE LASER RADIATION WHEN OPEN. AVOID DIRECT EXPOSURE TO BEAM.

PELIGRO—RADIACIONES VISIBLES E INVISIBLES DE LÁSER CUANDO ESTÁ ABIERTA. EVITE LA EXPOSICIÓN DIRECTA AL RAYO.

